

INSTALLATION & USER INSTRUCTIONS

WEATHER COMPENSATION CONTROLLER FW 100

FOR USE WITH THE FOLLOWING APPLIANCES:

GREENSTAR CDI COMBINATION BOILERS
GREENSTAR CDI SYSTEM BOILERS FITTED WITH OPTIONAL INTEGRAL DIVERTER VALVE
GREENSTAR HIGHFLOW CDI COMBINATION BOILERS

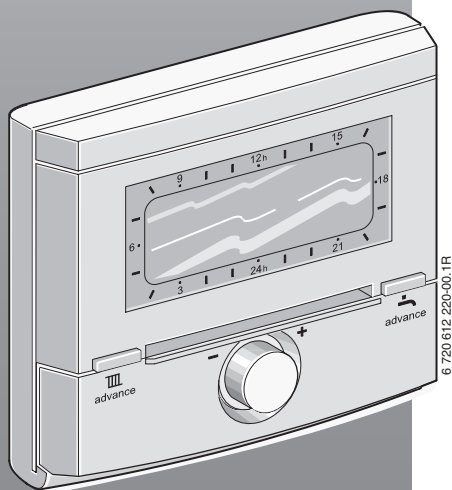

6 720 612 220-00.1R

Overview of controls and symbols

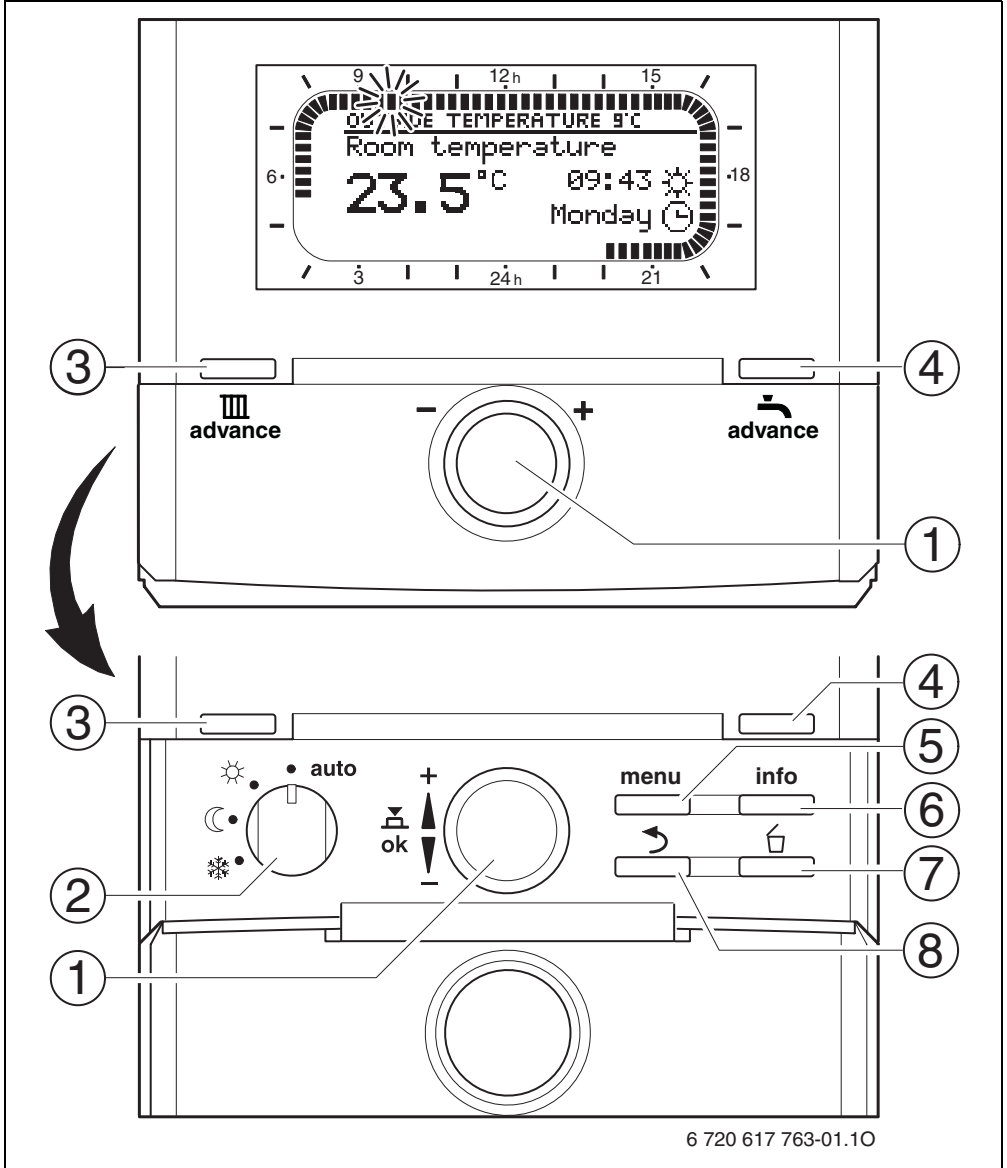



































Fig. 1 Controls

Controls	
1	Turning rotary selector  in + direction: scrolls menu/information up or increases setting value
	Turning rotary selector  in - direction: scrolls menu/information down or decreases setting value
	Pressing rotary selector  : opens menu or confirms setting/value or switches heating circuit
2	Mode selector for heating circuits:
	 auto Automatic mode
	 Continuous Comfort
	 Continuous Economy
	 Continuous Frost
3	 : Bring forwards the next switching point and the associated operating mode  = Comfort ,  = Economy ,  = Frost for the heating circuit to now.
4	 : Activate DHW heating immediately. The domestic hot water cylinder is heated to the desired temperature for 60 minutes or, with combination boilers, Comfort mode is activated for 30 minutes.
5	 : Open/close menu
6	 : Show settings
7	 : Delete/reset setting
8	 : Return to next menu up

Tab. 1

Symbols	
	Current room temperature (only with wall mounting)
	Flashing segment: Time now (between 09:30 and 09:45)
	Solid segments: time set for operating mode  = Comfort today or domestic hot water On (or ≥ 50 °C) (1 segment = 15 min)
	Blank segments: time set for operating mode  = Economy today or domestic hot water Off (or > 20 °C and < 50 °C) (1 segment = 15 min)
	No segments: time set for operating mode  = Frost today or domestic hot water ≤ 20 °C (1 segment = 15 min)
	Operating mode Comfort for heating circuit
	Operating mode Economy for heating circuit
	Operating mode Frost for heating circuit
	Automatic mode for heating circuit
	Holiday mode
	Burner operating
	Return to next menu up
	Other display information (menu options) are available. They can be viewed by turning the rotary selector  .

Tab. 2

Contents



Chapters against a grey background are intended for installers. The pages concerned are identified by a grey vertical bar at the side of the page.

Overview of controls and symbols 2
---	----------------

Information about this documentation	.. 6
---	-------------

1 Symbols and safety precautions 7
1.1 Symbols 7
1.2 Safety precautions 8

2 Technical data for the accessory item	... 9
2.1 Standard package 9
2.2 Intended use 9
2.3 Technical data 10
2.4 Supplementary accessories 10
2.5 Cleaning 10
2.6 Sample system 11

3 Installation (for installers only) 12
3.1 Installation 12
3.1.1 Installation in boiler 12
3.1.2 Wall mounting 13
3.1.3 Installation of outside temperature sensor 15
3.1.4 Fitting other accessories 16
3.1.5 Disposal 16
3.2 Electrical connections 16
3.2.1 Electrical connection, FW 100 in boiler facia 16
3.2.2 Electrical connection, FW 100 mounted on the wall 17

4 Commissioning (for installers only)	... 18
--	---------------

5 Operation 19
5.1 Heating and domestic hot water programmes 20
5.1.1 General Information 20
5.1.2 Weekly programmes 20
5.1.3 Structure of programmes 20
5.2 Setting programmes 21
5.2.1 Viewing on the display and navigating through the menu 21
5.2.2 Setting and changing switching times and operating modes 22
5.3 Manually setting operating modes 26
5.3.1 Selecting the heating mode 26
5.3.2 Advancing heating mode before the programmed time (bringing forward the next switching point) 26
5.3.3 Changing the domestic hot water mode (time-limited) 27
5.3.4 Holiday programme 27
5.4 Changing the specified room temperature 29
5.4.1 Permanently changing the specified room temperature 29
5.4.2 Changing the specified room temperature for a limited period	.. 29

6 MAIN MENU settings 30
6.1 MAIN MENU summary and settings	30
6.1.1 MAIN MENU: Holiday 31
6.1.2 MAIN MENU: Heating 32
6.1.3 MAIN MENU: Domestic hot water	.. 33
6.1.4 MAIN MENU: General settings	... 35
6.1.5 MAIN MENU: Solar 35
6.2 Heating programme 36
6.2.1 Timer programmes for heating	... 36
6.2.2 Temperature levels for operating modes and heating rate 38
6.3 DHW programme 39
6.3.1 Domestic hot water programme operating modes 40
6.3.2 Timer programme for domestic hot water with combination boiler	... 41
6.3.3 Time/temperature level program for domestic hot water via cylinder	.. 42

6.3.4	Timer programme for domestic hot water circulation pump (systems with domestic hot water cylinder only)	43
6.3.5	Parameters for domestic hot water	44
6.3.6	Thermal disinfection of domestic hot water	44
6.4	General settings	46
6.4.1	Time, Date and Auto switch between GMT - BST	46
6.4.2	Display formats	46
6.4.3	Key lock	46
6.4.4	Language	46
6.5	Solar settings	47
7	Viewing information	49
8	INSTALLER SETTINGS menu settings (for installers only)	52
8.1	INSTALLER SETTINGS menu summary and settings	52
8.1.1	INSTALLER SETTINGS: System configuration	53
8.1.2	INSTALLER SETTINGS: Heating parameters	53
8.1.3	INSTALLER SETTINGS: Solar system config	53
8.1.4	INSTALLER SETTINGS: Solar sys parameters	54
8.1.5	INSTALLER SETTINGS: Fault history	54
8.1.6	INSTALLER SETTINGS: Cust service address	54
8.1.7	INSTALLER SETTINGS: System info	55
8.1.8	INSTALLER SETTINGS: Floor drying	55
8.2	Configuring the heating system	56
8.3	Parameters for heating	56
8.4	Configuring the solar thermal system	60
8.5	Parameters for solar thermal system	60
8.5.1	Commissioning the solar thermal system	60
8.5.2	Parameters for the standard solar thermal system	61
8.5.3	Parameters for solar optimisation	62
8.6	Fault history	64
8.7	Viewing and entering the customer service address	64
8.8	Viewing system information	64
8.9	Screed drying function	65
9	Troubleshooting	66
9.1	Troubleshooting using the display (for installers only)	66
9.2	Troubleshooting without using the display	70
10	Tips on saving energy	72
11	Environmental protection	73
12	Commissioning log for the heating system	74
13	Individual timer programme settings	75
13.1	Heating programme for heating system	75
13.2	DHW programme	79
13.3	Domestic hot water circulation programme	80
	Index	81

Information about this documentation

Guide to instructions



These installation and operating instructions contain all details of the function and operation of the FW 100 heating controller.



The successful operation of the FW 100 Weather Compensation Controller relies upon the **minimum outside temperature** being adjusted to UK standards. Refer to page 59 for further information.

If you ...

- ... are looking for the safety instructions and an explanation of the symbols, refer to **Section 1**.
- ... are looking for a summary of the design and function of the FW 100 heating controller, refer to **Section 2**. You will also find the technical data there.
- ... are an INSTALLER and you want to know how to install, electrically connect and commission this accessory, refer to **Sections 3 and 4**.
- ... want to know how to operate and program this accessory, refer to **Sections 5, 6 and 13**. There you will also find summaries of the default settings and setting ranges for the menus. There are also tables for making a note of your settings.
- ... want to view information about the operating mode of the heating system, refer to **Section 7**.
- ... are an INSTALLER and want to make installer settings or view system information, refer to **Section 8**. There you will also find summaries of the default settings and setting

ranges for the menus. There are also tables for making a note of your settings.

- ... are looking for troubleshooting tables, refer to **Section 9**.
- ... are looking for tips on saving energy, refer to **Section 10**.
- ... are looking for a particular reference in the document, have a look in the **Index** at the end of this booklet.

1 Symbols and safety precautions

1.1 Symbols



Safety instructions in this document are framed and identified by a warning triangle which is printed on a grey background.

Signal words indicate the seriousness of the hazard in terms of the consequences of not following the safety instructions.









- **Caution** indicates that minor damage to property could result.
- **Warning** indicates that minor personal injury or serious material losses could result.
- **Danger** indicates that serious personal injury could result. In particularly serious cases, lives could be at risk.



Notes are identified by the symbol shown on the left. They are bordered by horizontal lines above and below the text.

Notes contain important information in cases where there is no risk of personal injury or material losses.

Conventions used in these instructions for representing the menu structure:

- Individual menu levels are separated by the character > , e.g. **Holiday > Start**
- Parameters that can be set/selected on a menu are marked with a bullet point • .
- The operation of a control is indicated by the symbol for the control:
 -  means turn rotary selector
 -  means press rotary selector
 -  means press and release Menu button
 -  means press and release Info button
 -  means press and release Delete/Reset button
 -  means press and release Menu Up button
 -  means press and release Advance button
 -  means press and release Immediate Domestic hot water button

1.2 Safety precautions

- ▶ These instructions must be observed to ensure correct operation.
- ▶ Install and commission the boiler and all accessories in accordance with the installation instructions.
- ▶ This accessory must only be installed by suitably qualified installers.
- ▶ Only use these accessories in conjunction with the heating appliances listed. Follow the connection diagram!
- ▶ Do not connect this accessory to the 230 V mains electricity supply.
- ▶ Before installing these accessories: Isolate the voltage supply (230 V AC) to the heating appliance and all additional devices on the bus.
- ▶ Never install this accessory in wet areas.
- ▶ Instruct customers about the functions and operation of accessories.
- ▶ Risk of scalding during thermal disinfection: Supervise short periods of boiler operation with water temperatures over 60 °C or fit a thermostatic mixer unit.
- ▶ When there is a risk of frost, leave the boiler switched on and follow the frost protection information.

Risk of damage due to operator error.



Incorrect operation can cause personal injury and/or damage to property.

- ▶ Ensure children do not operate or interfere with this accessory.
- ▶ Make sure that only people who are capable of operating this accessory properly have access to it. This appliance must only be operated by a responsible adult who has been instructed in, understands and is aware of its operating conditions and effects.

2 Technical data for the accessory item



The FW 100 can only be connected to a boiler with BUS-enabled Heatronic 3. It is intended to be installed in the boiler but can be wall mounted.

- This controller is used to display boiler and system information and to change the settings shown. The FW 100 can either be used with a System Boiler fitted with an optional integral diverter valve or a Combination boiler.
- The controller is a weather-compensated controller for a heating circuit and domestic hot water provision with time programs:
 - Central heating : 3 weekly heating programmes with 6 switching points per day are programmable (one programme is active).
 - Domestic hot water : weekly domestic hot water programme with 6 switching points per day.
- Options:
 - ISM 1 module for solar water heating.
- Installation:
 - In boiler with BUS-enabled Heatronic 3
 - Wall-mounted with BUS link to boiler with BUS-enabled Heatronic 3
- The controller has a back-up battery sufficient for at least 6 hours of operation. If the controller is without power for a period longer than the power reserve then the time and date will be deleted. All other settings are saved.

2.1 Standard package

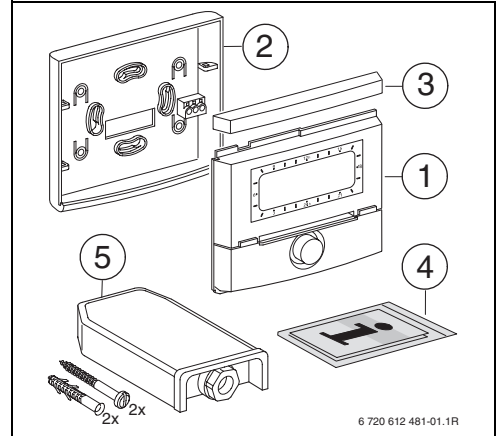

Fig. 2 Standard package

- 1 Controller top section
- 2 Base for wall-mounting
- 3 Slide cover
- 4 Installation and operating instructions
- 5 Outside temperature sensor with fixings

2.2 Intended use

The device must only be used for the control of heating systems. Any other application will be considered incorrect use. No liability for any losses resulting from such use is accepted.

2.3 Technical data

Dimensions	Fig. 8, page 13
Rated voltage	10...24 V DC
Rated power (excluding illumination)	6 mA
Controller output	2-wire BUS
Permissible ambient temperature	0 ... +75 °C
Class of protection	III
Protection level: - installed in Heatronic 3 - wall-mounted	IPX2D IP20
	CE

Tab. 3 Specification

°C	Ω_{AF}	°C	Ω_{AF}
- 40	4124	- 4	1342
- 36	3776	± 0	1149
- 32	3419	4	984
- 28	3064	8	842
- 24	2718	12	720
- 20	2392	16	616
- 16	2088	20	528
- 12	1811	24	454
- 8	1562		

Tab. 4 External temperature sensor measurements

2.4 Supplementary accessories

- **ISM 1:** module for controlling solar water heating.

2.5 Cleaning

- ▶ If required, use a damp cloth to wipe the controller casing. Never use aggressive or acidic cleaning agents for this.

2.6 Sample system

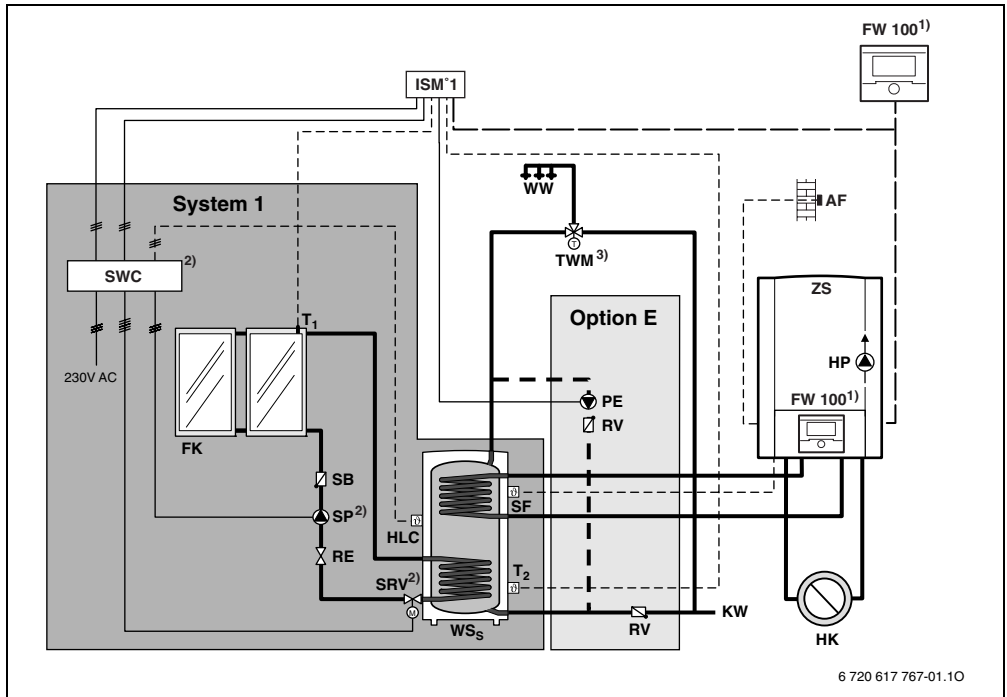

Fig. 3 FW 100 and CDi System Boiler with optional integral diverter valve and solar installation.

- | | | | |
|-----------------|--|-----------------------|---|
| AF | Outside temperature sensor | SRV | Solar return two port valve |
| FK | Flat plate collector | SWC | Solar wiring center |
| FW 100 | Weather compensation controller | System 1 | Solar cylinder for solar DHW heating |
| HK | Heating circuit | T₁ | Collector temperature sensor |
| HLC | High limit control | T₂ | Cylinder temperature sensor, bottom |
| ISM 1 | Module for solar water heating | TWM | Thermostatic mixing valve |
| HP | Heating circuit pump | WS_S | Solar storage cylinder |
| KW | Cold water connection | WW | DHW connection |
| Option E | Thermal disinfection of the solar cylinder | ZS | Boiler with cylinder connection |
| PE | DHW circulation pump thermal disinfection (option E) | 1) | The FW 100 can be mounted in the boiler or on the wall. |
| RE | Flow rate adjuster with indicator | 2) | See the installation instructions for the ISM 1 or the cylinder for further information |
| RV | Non-return valve | 3) | Install as close as possible to the cylinder |
| SB | Gravity brake | | |
| SF | Cylinder temperature sensor (NTC) | | |
| SP | Solar pump | | |

3 Installation (for installers only)



Danger: Risk of electric shock

- ▶ Before installing these accessories:
Isolate the voltage supply (230 V AC) to the heating appliance and all additional devices on the bus.

3.1 Installation

3.1.1 Installation in boiler

- ▶ Detailed description of boiler components, see boiler installation instructions.
- ▶ Remove outer casing.

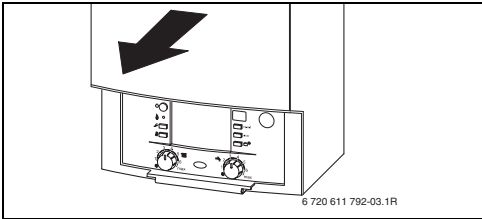

Fig. 4

- ▶ Remove cover plate and dummy cover.

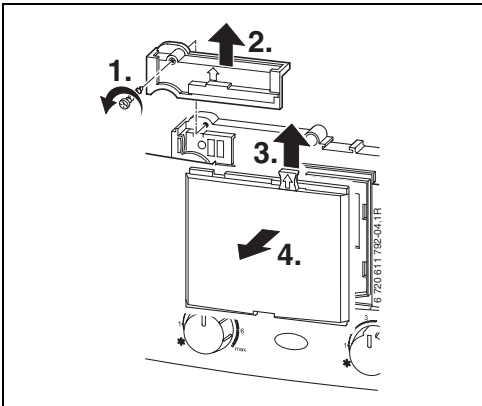

Fig. 5

- ▶ Insert top section in slots.

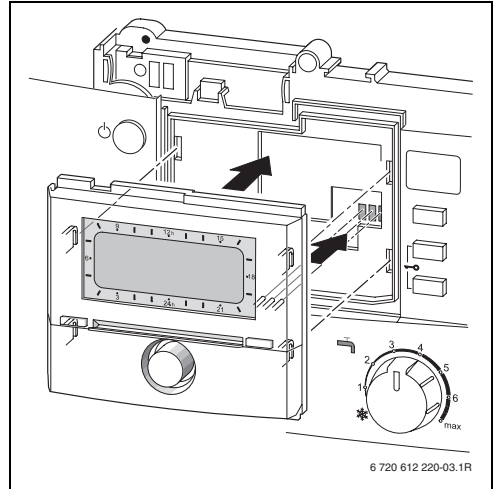

Fig. 6

- ▶ Click top section into place and mount cover plate.

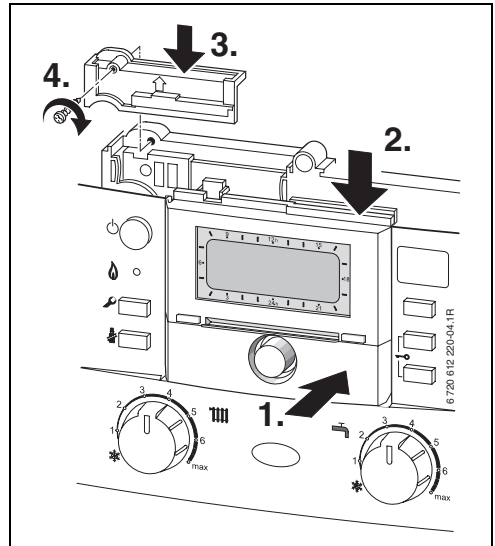

Fig. 7

3.1.2 Wall mounting

The installation location must be suitable for controlling the heating system or heating circuit.

The accuracy of the FW 100 is dependent upon the installation location.

Any radiator in the same room as the FW 100 should not have a thermostatic radiator valve fitted.

The FW 100 should be installed so that the overall temperature of the property is monitored, for example, hallways or landings and not be installed in a living room or room with supplementary heating.

- ▶ Select the installation location.

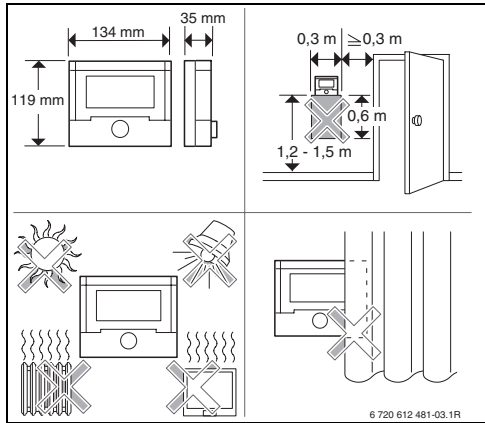

Fig. 8

- ▶ Remove the top section and slide cover from the base.

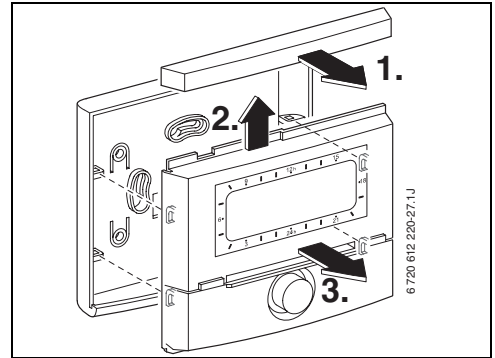

Fig. 9



The mounting surface on the wall should be level.

Installation (for installers only)

- Fit the base.

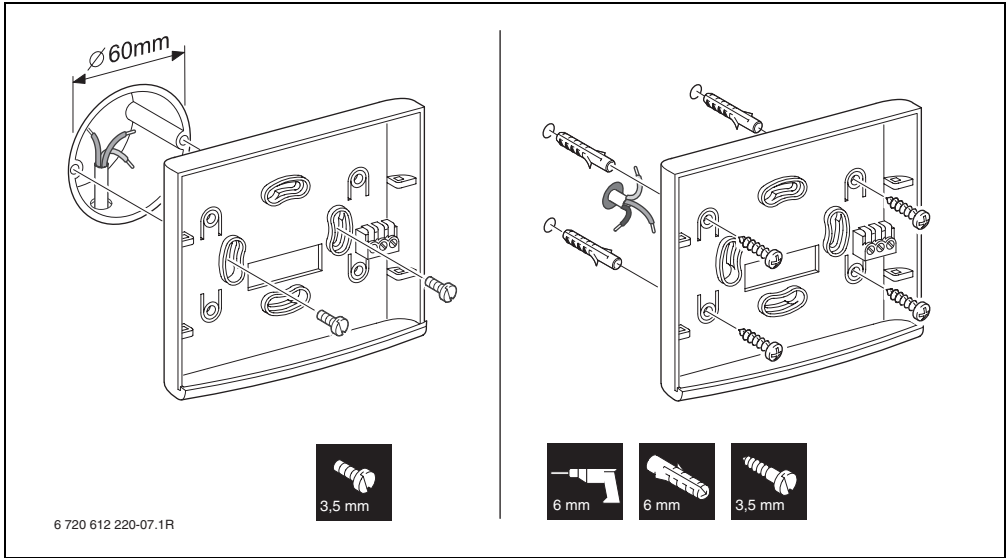

Fig. 10

- Make the electrical connections (→ Fig. 14 on page 16 or 15 on page 17).
- Refit top section and slide cover on base.

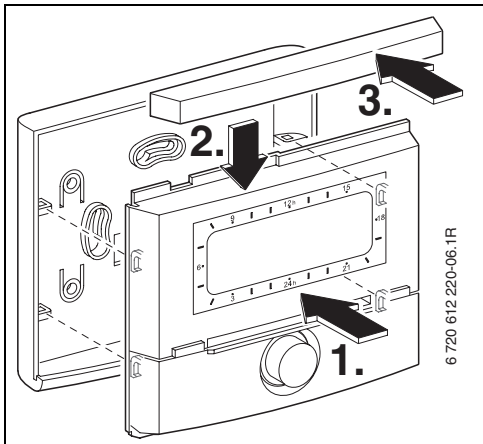

Fig. 11

3.1.3 Installation of outside temperature sensor

Control quality depends on installation location of outside temperature sensor AF.

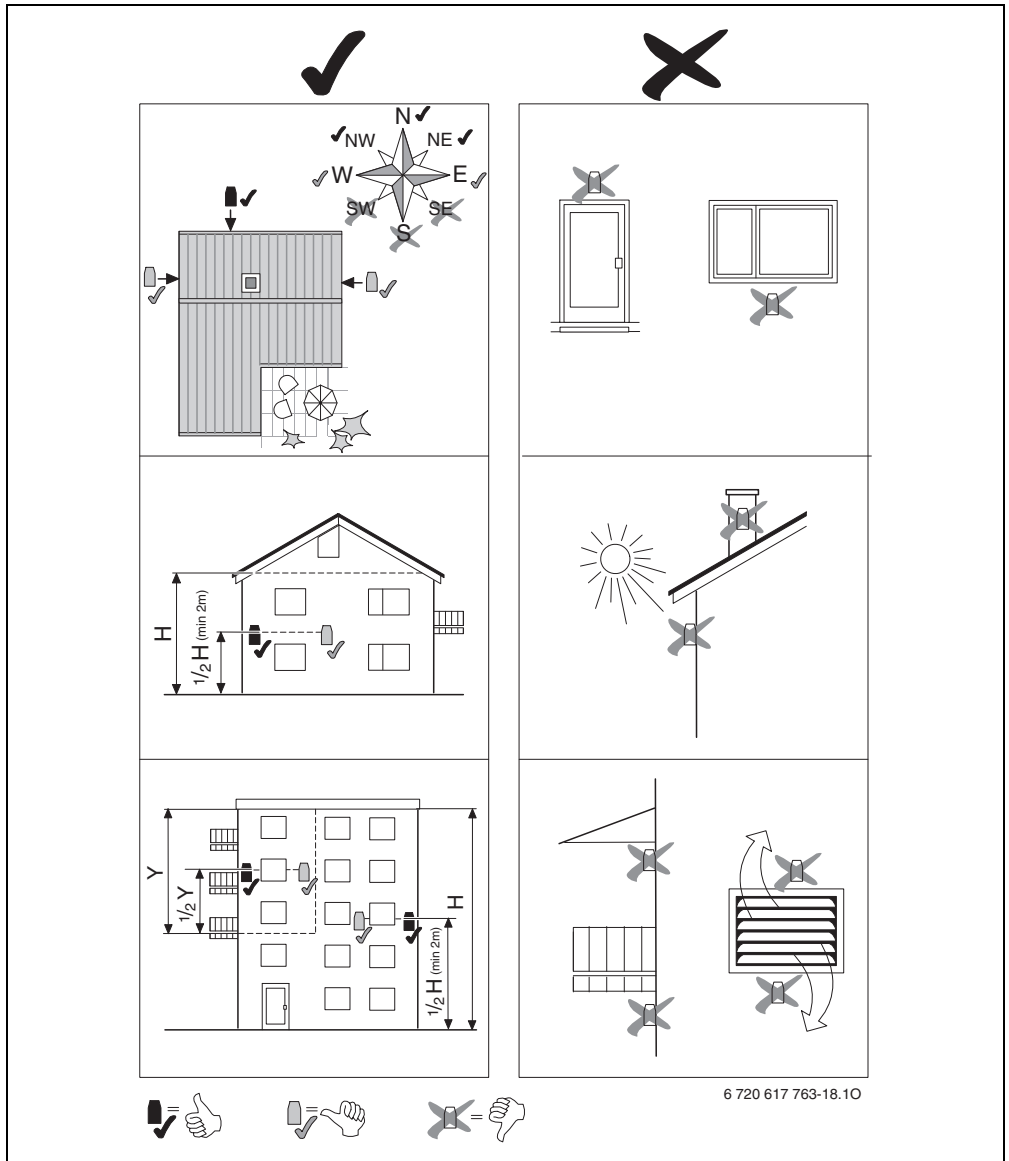

Fig. 12

Installation (for installers only)

- ▶ Select installation location (→ Fig. 12).
- ▶ Remove cover.
- ▶ Fix sensor housing to external wall with two screws.

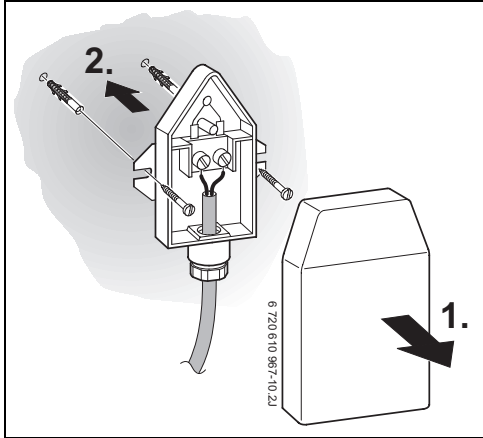

Fig. 13

3.1.4 Fitting other accessories

- ▶ Fit accessories according to the legal requirements and the installation instructions supplied with them.

3.1.5 Disposal

- ▶ Dispose of packaging in an environmentally responsible manner.
- ▶ When replacing components, dispose of the old parts in an environmentally responsible manner.

3.2 Electrical connections

3.2.1 Electrical connection, FW 100 in boiler facia

- ▶ Installation of the controller automatically produces BUS connection via the three contacts (→ Fig. 6 on page 12).

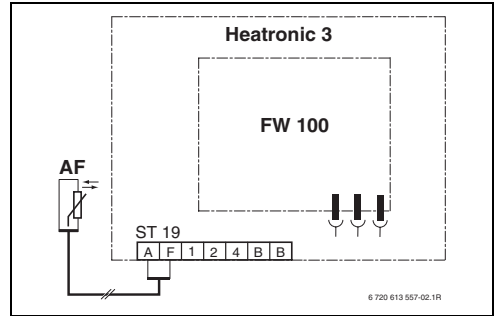

Fig. 14 Controller installed in facia via BUS contacts in BUS-enabled Heatronic 3.



The controller recognises that the boiler is installed via the third contact.

3.2.2 Electrical connection, FW 100 mounted on the wall

- ▶ Use electrical cable with a minimum rating of H05 VV... (NYM-I...).
- ▶ To avoid inductive interference, lay all bus cables separately to lines of 230 V or 400 V (minimum spacing 100 mm).

- ▶ In case of external inductive interference, shield the cables. This ensures that the cables are shielded from external interference (e.g. heavy current cables, overhead wires, transformer stations, radio and television set, amateur radio stations, microwave ovens etc).

Permissible cable lengths from the BUS-enabled Heatronic 3 to the controller:

Cable length	Cross-section
≤ 80 m	0.40 mm ²
≤ 100 m	0.50 mm ²
≤ 150 m	0.75 mm ²
≤ 200 m	1.00 mm ²
≤ 300 m	1.50 mm ²

Tab. 5

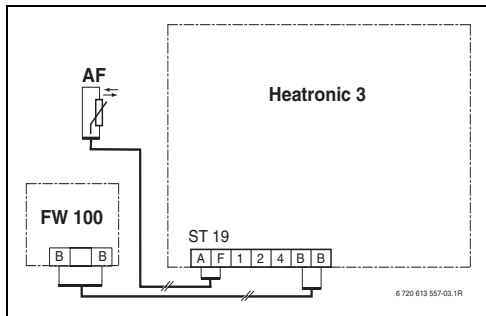

Fig. 15 Controller connected to BUS-enabled Heatronic 3.



If the BUS cables feature different cross-sections:

- ▶ Connect BUS link via a branch box.

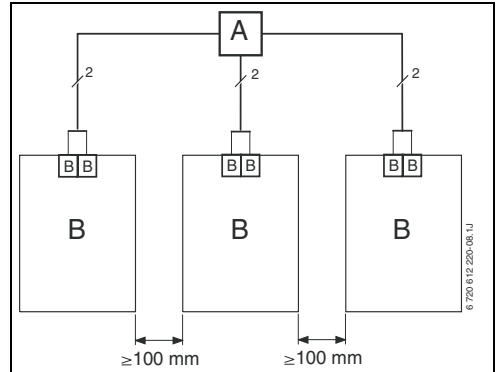

Fig. 16 BUS links connected via branch box (A)

Permissible cable lengths to outside temperature sensor:

Cable length	Cross-section
≤ 20 m	0.75 mm ² ... 1.50 mm ²
≤ 30 m	1.00 mm ² ... 1.50 mm ²
≥ 30 m	1.50 mm ²

Tab. 6













4 Commissioning (for installers only)

For correct commissioning, it is essential that the following steps are carried out in the order shown.

1. Switch on the system.



The functions of the controls and the meanings of the symbols on the display are explained on pages 2 and 3.

2. When commissioning for the first time or after a complete reset (all settings have been reset):
 - Turn to  select the language and press  to confirm. (For how to change the language → Section 6.4.4 on page 46.)
3. If the reserve power supply has run out, set the date and time as follows:
 - Turn  to select the hour and press  to confirm.
 - Turn  to select the minute and press  to confirm.
 - Turn  to select the year and press  to confirm.
 - Turn  to select the month and press  to confirm.
 - Turn  to select the day and press  to confirm. (For how to change the date and time → Section 6.4.1 on page 46.)
4. When the unit is first commissioned, automatic system configuration starts immediately after entry of the date and time.
 - Wait for 60 seconds and then follow the instructions displayed.
 - If automatic system configuration does not start of its own accord, start it from the menu → Section 8.2 on page 56.
5. Adjust other settings to suit the specifics of the system, → Section 6 starting on page 30 and Section 8 starting on page 52.
6. Fill and bleed the solar thermal system according to its documentation and prepare it for commissioning as described in Section 8.4 on page 60.
7. Adjust other settings to suit the specifics of the solar thermal system, → Section 8.5 starting on page 60.
8. Commission the solar thermal system, → Section 8.5.1 on page 60.
9. Inform the user of the system about its function and method of operation as follows:
 - Explain to the customer how the boiler and the controller work and how to operate them.
 - Explain to the user the operations for day-to-day use, e.g. setting the time, operating modes for the heating systems, domestic hot water temperature, timer programmes for heating and domestic hot water.
 - Explain the use of the thermal disinfection function and the associated risk of scalding.
 - Hand all documentation supplied to the user.
10. Complete the commissioning log, → Section 12 on page 74.

5 Operation

Introduction

With the FW 100 heating controller, you can automatically control the room temperature and domestic hot water temperature with a heating and hot water programme created according to your own individual requirements.

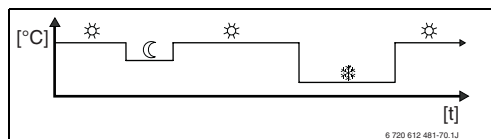

Fig. 17 Example of heating programme

Once the controller is set to your personal preferences, you hardly need the menus for “everyday use”. Nevertheless, it is useful to be familiar with the basic use of the menus.

Therefore, you should read the whole of Sections 5.1 and 5.2 below and adjust a heating or domestic hot water programme to your own requirements as described in Section 5.2.2.

The procedure for changing a switching point will illustrate everything you need to know about navigating through the menus and entering settings. You can then make all other settings in the same way with the aid of the information in Sections 6 and 8.

The description of the menus reflects the arrangement of the menu options on the heating controller. The tables in Sections 6.1, 7 and 8.1 show the entire menu structure. They also provide details of the adjustment ranges and default settings for all adjustable parameters. More information on the menu options can be found in Sections 6.2 to 6.5 for user settings, and Sections 8.2 to 8.9 for installer settings.

The description of a menu options starts with its menu path. That shows you how to reach the menu option concerned through the system of

menus. The individual menu levels are separated by the character >, e.g. Holiday > Start

Some menu options are dependent on others. In such cases, a page reference directs you to a description of the menu option on which it depends. Make use of such page references to other menu options. They will help you to understand associated functions.



The controller provides the option of setting the desired room temperature for the operating mode concerned. This temperature entry is not the actual room temperature. This is an orientation value that influences the required flow temperature for the heating circuit.

5.1 Heating and domestic hot water programmes

5.1.1 General Information

The programmes for heating and hot water enable you to achieve maximum energy savings while still enjoying optimum comfort in terms of room temperature and availability of domestic hot water. That is achieved, for instance, by deactivating water heating in the periods when nobody requires domestic hot water.

5.1.2 Weekly programmes

All timer programmes are set up to repeat every seven days. In the programme memory you can store 6 switching points for every day in each programme, i.e. a total of up to 42 switching points.

To simplify programming, you can set switching points for groups of days as well as for individual days.

The following groups of days are offered:

- **All days**
- **Mon - Fri**
- **Sat + Sun**

If, for example, you change and store a switching point for the option **Mon - Fri**, that change is simultaneously applied to all days from **Monday** to **Friday**.

5.1.3 Structure of programmes

Programmes for heating and domestic hot water are always structured in the same way. Up to six switching points (times) can be specified. A change of operating mode is specified for each switching point. The specified operating mode applies until changed by the next switching point.

Heating programmes

Heating programmes control central heating operation. There are three modes for heating operation:

- **Comfort** ☀
- **Economy** ☾
- **Frost** (Frost protection) ❄

For each of those operating modes, there is a specified room temperature stored on the FW 100 heating controller (→ Section 5.4.1, page 29).

There are a total of three programme spaces (A to C) available for heating programmes. Each heating programme contains the switching times for one week (weekly programme). You can activate one of the heating programmes for the heating system.



Having several stored heating programmes simplifies changing from one heating programme to another, e.g. if your job involves periods when you work different shifts (night shift/day shift), or for holiday periods.

Domestic hot water programmes

Domestic hot water programmes operate differently according to the type of hot water system:

- With combination boilers (boilers which produce domestic hot water instantaneously on demand) the hot water programme switches between the following operating modes:
 - **On:** if the Eco button on the boiler is not lit, domestic hot water is available very quickly on demand (Comfort mode).
 - **Off:** the built-in plate heat exchanger in the boiler is not kept constantly hot (Eco mode); as a result energy is saved. In Eco mode, the hot tap has to be run for a short while before the water becomes hot.
- With boilers connected to a hot water cylinder, the hot water programme specifies the desired water temperature (specified temperature).

- If the temperature measured in the domestic hot water cylinder is below the specified temperature, the cylinder is re-heated.
- Once the specified temperature is reached (or exceeded), cylinder heating is stopped.

You can set up a domestic hot water programme for the domestic hot water system.



If the domestic hot water programme changes from a higher to a lower specified temperature, the water in the cylinder will not immediately cool to the lower temperature, i.e. water at a higher temperature will continue to be available for some time. However, the cylinder will not be reheated until the temperature falls below the new, lower specified temperature.

DHW circulation program

The circulation programme specifies when a connected secondary circulation pump for domestic hot water runs.

You can set up a circulation programme for the domestic hot water system.

5.2 Setting programmes

















The functions of the controls and the meanings of the symbols on the display are explained on pages 2 and 3.

5.2.1 Viewing on the display and navigating through the menu

The user interface of the weather compensation controller FW 100 is implemented as a menu system. Within that menu system, the various functions are arranged in a hierarchical structure. For greater clarity, the menu system is subdivided into three sections (**MAIN MENU**, **INFO**, and **INSTALLER SETTINGS**). Each section can be accessed by its own button. The entire menu structure is shown in tabular form in Sections 6.1, 7 and 8.1.

To navigate through the menu system:

- Pressing  opens the **MAIN MENU**. From any point within the **MAIN MENU**, pressing  takes you back to the basic display.
- Pressing  opens the **INFO**. From any point within the **INFO** menu, pressing  takes you back to the main menu.
- Pressing and holding  for at least 3 seconds opens the **INSTALLER SETTINGS** menu. From any point within the **INSTALLER SETTINGS** menu, pressing  takes you back to the main menu.
- The menu option/parameter selected in each case is shown **inverted**.
- Arrows in the left margin indicate that there is more information than can be shown on the display at once. It can be viewed by turning the rotary selector .
- Pressing the rotary selector  opens the submenu associated with the selected menu option/parameter or activates editing mode for the parameter (the parameter setting starts flashing).

- A flashing parameter setting (e.g. switching point or operating mode)
 - can be changed by turning the rotary selector .
 - can be deleted (reset to the default) by pressing .
 - is stored by pressing the rotary selector .
 - remains unchanged if any other button apart from the rotary selector  is pressed.
- To return to the next menu up from a sub-menu:
 - Select the menu option **◀ Back** and confirm by pressing the rotary selector , or
 - Press .

5.2.2 Setting and changing switching times and operating modes

The way in which switching points and operating modes are set is always the same, the only differences are due to the various operating modes for each switching point.

The unit is supplied with programmes for heating and domestic hot water already stored. It may also be that your heating installer has adjusted the programmes to suit your requirements.

Changing (moving or deleting) a single switching point



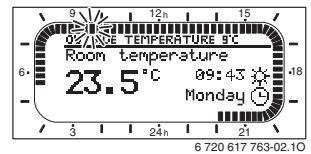

The example below shows all the steps required to change a switching point in a heating programme. If, instead, you want to change a switching point in a domestic hot water programme, open the domestic hot water programme concerned (menu path: **Domestic hot water > DHW programme > Edit**) and change the switching point in the same way.

- ▶ Open flap.
The basic display continues to be shown.

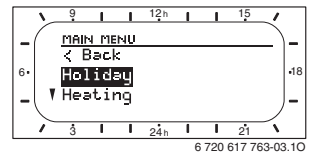

- ▶ Press .
- The display lighting switches on and the main menu is displayed.



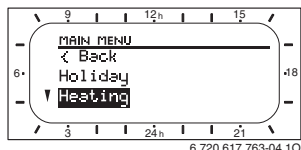

- ▶ Turn the rotary selector  until the menu option **Heating** is selected.



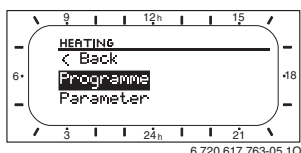

- ▶ Press . The Heating menu is selected and the title bar shows the current menu name (in this case **HEATING**).



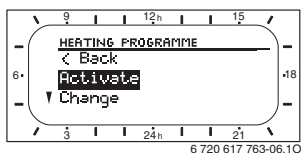

- ▶ Turn the rotary selector  until the menu option **Programme** is selected.
- ▶ Press . The Programme menu is selected and the title bar shows the current menu name (in this case **HEATING PROGRAMME**).



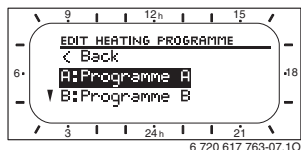

- ▶ Turn the rotary selector  until the menu option **Edit** is selected.
- ▶ Press . The Edit menu is selected and the title bar shows the current menu name (in this case **EDIT HEATING PROGRAMME**).

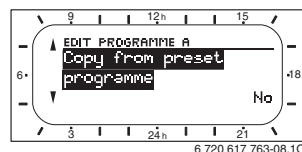

- ▶ Turn the rotary selector  until the desired heating programme is selected (e.g. **A:Programme A**).

- ▶ Press . The heating programme (e.g. A:Programme A) is selected and the title bar shows the current menu name (**EDIT PROGRAMME A**).



- ▶ Turn the rotary selector  until the desired day (or group of days) is selected (e.g. **Monday**).

The display always shows the ring of segments representing the heating programme settings when you select a single day (e.g. **Monday**) or a group of days in which the switching points are identical for all the days in that group (e.g. all switching points for **Mon - Fri** identical).

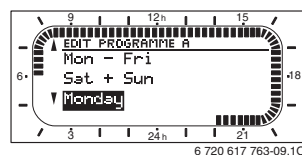

- ▶ Press the rotary selector  to confirm the menu option **Monday**.

The next submenu (**EDIT PROGRAMME A MON**) showing the programmed switching points and operating modes **P1** to **P6** is displayed.

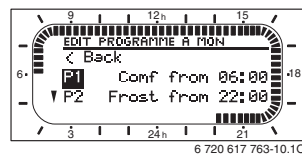

- ▶ Turn the rotary selector  until the menu option **P1** (= switching point 1) is selected.

- ▶ Press .

The switching point and corresponding segment on the display start to flash.

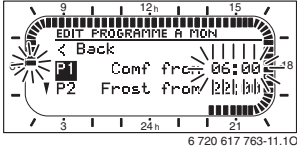

- ▶ Turn the rotary selector  until the desired time is displayed (e.g. **05:30** h).

The ring of segments around the perimeter of the display always shows the effect of the change on the heating programme.

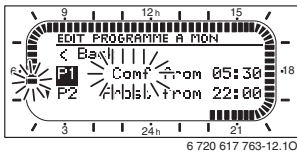

- ▶ Press .

The switching point is saved. The associated operating mode now starts flashing on the display.

- ▶ Turn the rotary selector  until the desired operating mode (e.g. **Economy** is displayed). The ring of segments around the perimeter of the display always shows the effect of the change on the heating programme.

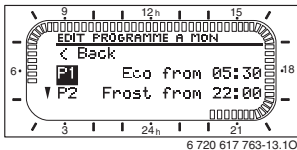

- ▶ Press .

The operating mode is saved. Setting of **P1** is now complete.

- ▶ You can now:
 - change more switching points and operating modes in the same way, or
 - finish programming and return to the basic display by pressing .

Using groups of days when programming

In many cases, you may want to programme the same switching points for several days of the week, say for all working days. Equally, you may also want a different programme for just one of those days.

Using the groups of days when programming enables you to complete the process in only a few steps.

- ▶ For a group of days, e.g. **Mon - Fri**, programme the switching points and operating modes that are the same for the majority of those days.
- ▶ Then change the switching points for the days that are different.

Copying ready-made programmes

There are eight ready-made heating programmes permanently stored on the heating controller. They can not be directly applied to a heating circuit.

To be able to use the ready-made heating programmes, you must copy them to one of the locations for heating programmes (A to C), where you can also adapt them if necessary (→ Section 5.2.2).



You can also copy any of the programmes A to C to another storage location as a template.

Select the storage location **to which the programme is to be copied** (A to C):

- ▶ Open menu option **Heating > Programme > Edit > A:Programme A ... C:Programme C**.
- ▶ Press the rotary selector $\frac{\Delta}{ok}$ twice. The function **Copy from preset programme** is selected and the option **No** is flashing.

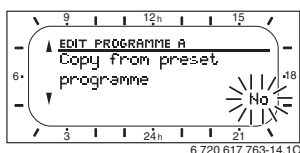

- ▶ Turn the rotary selector \updownarrow until the last line of the display shows the heating programme that is to be copied (e.g. **Full weekday worker**).
- ▶ Press $\frac{\Delta}{ok}$. The heating programme has now been copied.

Resetting an entire programme (replacing with default settings)

The unit is supplied with programmes for heating and domestic hot water already stored in the memory (→ Section 13 on page 75).

Overwrite one of your own heating programmes, A to C, as follows:

- ▶ Open the programme concerned (e.g. menu path: **Heating > Programme > Edit > C:Programme C** or menu path: **Domestic hot water > DHW programme > Edit**).
- ▶ Turn the rotary selector \updownarrow to select the option **Reset factory settings**.
- ▶ Press $\frac{\Delta}{ok}$. The programme has now been reset to the default settings.

Resetting all settings (for installers only)

This function resets all settings on the **MAIN MENU** and the **INSTALLER SETTINGS** to their default settings. **Following such a reset, your heating installer will need to commission the system again!**

If the basic display is showing:

- ▶ Simultaneously press and hold menu and 6 until the following warning message appears:

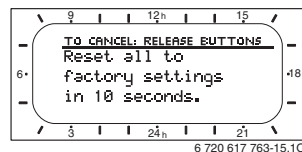

- ▶ Continue holding menu and 6 until the following message appears:

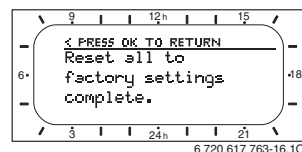

- ▶ Press $\frac{\Delta}{ok}$. All settings have now been reset to their defaults with the exception of the date and time, which remain unchanged.

5.3 Manually setting operating modes

5.3.1 Selecting the heating mode



In normal operation, always leave the rotary selector in the **auto** position. By using correctly set heating programmes, you can save energy while enjoying comfort.

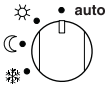

Automatic mode (default setting)

Switches automatically between the modes **Comfort** ☀ / **Economy** ☾ / **Frost** ❄ according to the active heating programme.

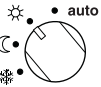

Constant heating

The controller constantly maintains the room temperature set for **Comfort** ☀ mode.

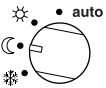

Constant economy

The controller constantly maintains the room temperature set for **Economy** ☾ mode.



Constant frost protection

The controller constantly maintains the room temperature set for **Frost** ❄ mode.

5.3.2 Advancing heating mode before the programmed time (bringing forward the next switching point)

This function brings forward the time at which the mode **Comfort** ☀ / **Economy** ☾ / **Frost** ❄ set for the next switching point becomes active.



The change applies only to the day on which you activate the function.



- ▶ The function can be used in situations such as going to bed earlier, being away from home longer or coming back later.
- ▶ If you are going to be away from home for several days, e.g. on holiday, you should use the Holiday function, → Section 5.3.4, page 27.

This function is only available when **auto** mode is switched on.

- ▶ Press and release  to bring forwards the next switching point and the associated operating mode **Comfort** ☀ / **Economy** ☾ / **Frost** ❄ for the selected heating circuit to now.

The segments around the perimeter of the display show the changed settings.

-or-

- ▶ Press and hold  and simultaneously turn the rotary selector  to change the next switching point.
- The segments around the perimeter of the display show the changed settings.

To undo the change to the switching point:

- ▶ Press  again.

5.3.3 Changing the domestic hot water mode (time-limited)



You can use this function if you need domestic hot water outside the programmed times (→ Section 6.3, Seite 39).

- ▶  Press and release to activate domestic hot water mode immediately.
 - The hot water cylinder is heated up to the temperature set in the domestic hot water programme for 60 minutes.
 - With a combination boiler, Comfort mode is activated for 30 minutes.

To undo the change to the domestic hot water mode:

- ▶ Press  again.

5.3.4 Holiday programme

You can use this function if you want to set a constant operating mode for several days (e.g.

Frost ) without changing the heating programmes.









The holiday programme only has an effect on the boiler if the boilers holiday function is not activated.

When the holiday programme is active, the heating circuits and domestic hot water systems are operated according to the operating mode set in the holiday programme (frost protection is automatically provided).

- ▶ Press . The display lighting switches on and the main menu is displayed.



6 720 617 763-03.10

- ▶ Press . The Holiday menu is selected and the title bar shows the current menu name (in this case **Holiday**).
- ▶ Press the rotary selector , the display changes to the Holiday menu and **Start** is selected. Now you can enter date on which you want the holiday programme to start. Enter the year, month and day one after the other and confirm your entry in each case by pressing the rotary selector .
- ▶ Turn the rotary selector  so that **End** is selected.
- ▶ Press . Now you can enter the date on which you want the holiday programme to end. Enter the year, month and day one after the other and confirm your entry in each case by pressing the rotary selector .





If you have set the holiday programme to start on today's date, it will start immediately. If the date is in the future, the holiday programme will start at 00:00 hours on the set start date.
It will end at 23:59 hours on the set end date.

Programming of the holiday programme is now complete. If required, you can adjust the heating and domestic hot water modes. The following modes are set by default:

- **Heating system: Frost** ❄️ mode
- **Domestic hot water: Off** mode ¹⁾ or **15 °C** ²⁾.
- **DHW circulation pump: Off** mode.
- **Thermal disinfection: Off** mode.

When the holiday programme is active, the standard display shows  and the dates, e.g. **HOLIDAY UNTIL 09/30/2008**.

To cancel the holiday programme early:

- ▶ Select menu option **Holiday > Start**.
- ▶ Press the rotary selector  and then press .
The display shows ---:---:---.
- ▶ Press the rotary selector  to store the setting.

1) Domestic hot water provided by combination boiler

2) Domestic hot water provided by DHW cylinder

5.4 Changing the specified room temperature



The controller provides the option of setting the desired room temperature for the operating mode concerned. This temperature entry is not the actual room temperature. This is an orientation value that influences the required flow temperature for the heating circuit.

5.4.1 Permanently changing the specified room temperature

The following temperatures are stored as the default settings for the specified room temperature:

- **Comfort** ☀ mode: 21 °C
- **Economy** ☾ mode: 15 °C
- **Frost** ❄ mode: 5 °C

The heating controller controls the heating system so that actual room temperature is kept as close as possible to the specified temperature for the set operating mode (in **auto** mode as determined by the active heating programme and the time of day). You can amend these set values independently for each heating circuit.

If you wish to permanently alter the specified room temperature settings, proceed as follows:

- ▶ Open menu option **Heating > Parameter > Heating levels.**
- ▶ Set values for each operating mode.

5.4.2 Changing the specified room temperature for a limited period

- ▶ Set the desired room temperature using the rotary selector . While you are changing the set room temperature the display shows the desired room temperature or a bar ¹⁾, which shows a set change.
 - If the mode selector is set to **auto**:
The new temperature applies until the next switching point.
 - If the mode selector is set to ☀ / ☾ / ❄:
The new temperature applies until the mode selector position is changed.

1) The bar is shown if the heating controller FW 100 is installed in the boiler facia or room influence is not active. For setting the room influence for installers, see page 58

6 MAIN MENU settings

Detailed instructions on navigating through the menu structure, programming, deleting settings and resetting to the default settings are provided in Section 5.2 starting on page 21.

6.1 MAIN MENU summary and settings

The tables set out below provide

- an overview of the menu structure (column 1).
The menu level is indicated by different shades of grey.
For example, on the menu **Heating > Programme**, the submenus **Edit** and **View** are at the same level.
- an overview of the default settings (column 2), e.g. for the purposes of resetting individual menu options to the default.
- an overview of the adjustment ranges of the individual menu options (column 3).
- space for making a note of your personal settings (column 4).
- references to the detailed descriptions of the individual menu options (column 5).



The menu options are only shown if the system components are present and/or active.

Some menu options are not shown because they are switched off by a setting for another menu option.

- ▶ Always set or skip menu options in order. In that way, subsequent menu options will be automatically adjusted or not shown.
-

6.1.1 MAIN MENU: Holiday

Holiday menu structure ¹⁾	Default setting	Setting range	Personal setting	Description starts on page
Start	- - . - - . - - - -	Today ... 12/31/2099 (in increments of one day/month/year)		27
End	- - . - - . - - - -	Start date ... 12/31/2099 (in increments of one day/month/year)		
Heating system	Frost	Frost Economy Comfort Auto		
Domestic hot water	Off ²⁾	Off Auto On ²⁾		
	15 °C ³⁾	15 °C ... 60 °C Auto ³⁾		
DHW circulation pump	Off	Off Auto On		
Thermal disinfection	Off	Off On		

Tab. 7

- 1) Only influences the boiler if the holiday key on the boiler was not enabled.
- 2) Domestic hot water provided by combination boiler
- 3) Domestic hot water provided by domestic hot water cylinder

6.1.2 MAIN MENU: Heating

Heating menu structure	Default setting	Setting range	Personal setting	Description starts on page			
Programme	–	–	–				
Activate	A:Programme A (switching points from Home all day-programme)	A:Programme A ... C:Programme C (Programme name can be changed)	–				
Edit	–	–	–				
A: Programme A ... C: Programme C	–	–	–				
Copy from preset programme	No	No A:Programme A ... C:Programme C (Programme name can be changed) AM weekday worker PM weekday worker Full weekday worker AM+PM weekday worker Home all day Home all day, early Home all day, late Senior citizens	–				
All days	→ table starting on page 75	→ table starting on page 77	→ table starting on page 78	36			
<input type="checkbox"/> P1, P2 ... P6 Mon - Fri							
<input type="checkbox"/> P1, P2 ... P6 Sat + Sun							
<input type="checkbox"/> P1, P2 ... P6 Monday, Tuesday ... Sunday							
<input type="checkbox"/> P1, P2 ... P6							
Reset factory settings					No	No Yes	
Programme name					As selected on Edit menu, e.g. Programme A	Different programme name	
View	–	–	–				
A: Programme A ... C: Programme C AM weekday worker PM weekday worker Full weekday worker AM+PM weekday worker Home all day Home all day, early Home all day, late Senior citizens	All days	All days Mon - Fri Sat + Sun Monday, Tuesday ... Sunday	–				
Parameter	–	–	–				
Heating levels	–	–	–				
Comfort	21.0 °C	0.0 °C ... 30,0 °C (not lower than Economy)	°C	38			
Economy	15.0 °C	0.0 °C ... 30 °C (not lower than Frost and not higher than Comfort)	°C				
Frost	5.0 °C	0.0 °C ... 30 °C (not higher than Economy)	°C				
Heating up speed	Normal	Economy Normal Fast					

Tab. 8

6.1.3 MAIN MENU: Domestic hot water

Domestic hot water menu structure	Default setting	Setting range	Personal setting	Description starts on page
DHW and DHW circulation pump	Separate programmes	Separate programmes As heating programme		
DHW programme ¹⁾	-	-	-	
Edit	-	-	-	
All days	→ table on page 79	→ table on page 79	→ table on page 79	39
P1, P2 ... P6				
Mon - Fri				
P1, P2 ... P6				
Sat + Sun				
P1, P2 ... P6				
Monday, Tuesday ... Sunday				
P1, P2 ... P6				
Reset factory settings	No	No Yes		
View	-	-	-	
All days Mon - Fri Sat + Sun Monday, Tuesday ... Sunday	-	-	-	
DHW circ pump prog ¹⁾	-	-	-	
Edit	-	-	-	
All days	→ table on page 80	→ table on page 80	→ table on page 80	43
P1, P2 ... P6				
Mon - Fri				
P1, P2 ... P6				
Sat + Sun				
P1, P2 ... P6				
Monday, Tuesday ... Sunday				
P1, P2 ... P6				
Reset factory settings	No	No Yes		
View	-	-	-	
All days Mon - Fri Sat + Sun Monday, Tuesday... Sunday	-	-	-	

Tab. 9

MAIN MENU settings

Domestic hot water menu structure		Default setting	Setting range	Personal setting	Description starts on page
Parameter		–	–	–	44
	Cylinder temp at heating level Comf.	60 °C	15 °C ... 60 °C	°C	
	Cylinder temp at heating level Eco	50 °C	15 °C ... 60 °C	°C	
	DHW priority	Priority	Priority Conditional priority		
	DHW circ pump cycles	4 per hour	1 per hour ... 7 per hour	per hour	
Thermal disinfection		–	–	–	44
	Operating mode	Manual	Manual Auto		
	Operating status	Not running	Not running Start now		
		Running	Running Stop		
	Time	01:00 h	00:00 hours ... 23:45 h ²⁾	h	
	Time interval	7 days	1 day ... 30 days	d	

Tab. 9

- 1) Only with “Separate programmes”
- 2) Display subject to the selected “Display format”

6.1.4 MAIN MENU: General settings

General settings menu structure	Default setting	Setting range	Personal setting	Description starts on page
Time and date	–	–	–	46
Time	– : – : –	00:00 ... 23:59 ¹⁾ (in increments of one hour/minute)	–	
Date	– . – . – . – . – – – –	01/01/2005 ... 12/31/2099 (in increments of one month/day/year)	–	
Auto switch between GMT - BST	Yes	Yes No		
Time adjustment	0.0 sec/week	– 60.0 sec/week ... +60.0 sec/week	sec/week	
Display format	–	–	–	46
Time	12 am/pm	12 am/pm 24h		
Date	DD.MM.YYYY	DD.MM.YYYY or MM/DD/YYYY		
Display contrast	According to factory test	25% ... 75%	%	
Information at top of display	Without ISM and cylinder: Outside temperature	Outside temperature Date		
	Without ISM, with cylinder: Outside temperature	Outside temperature Date Cylinder temperature		
	With ISM and cylinder: Solar pump status	Solar pump status Solar yield Outside temperature Date Cylinder temperature		
	With ISM but without cylinder: Solar pump status	Solar pump status Solar yield Outside temperature Date		
Key lock	Off	Off On		46
Language	English	English Deutsch Français Polski		46

Tab. 10

1) Display subject to the selected “Display format”

6.1.5 MAIN MENU: Solar

Solar menu structure	Default setting	Setting range	Personal setting	Description starts on page
T2: Max. solar cylinder temperature	60 °C	15 °C ... 90 °C	°C	47
Optimizing influence DHW ¹⁾	0 K	0 K (= function off) ... 20 K	K	
CH circuit optimizing influence	0 K	0 K (= function off) ... 5 K	K	

Tab. 11

1) Only available if collector area is set on Installer settings

6.2 Heating programme

Main menu: Heating



Set the flow temperature control on the boiler to the maximum required flow temperature.

6.2.1 Timer programmes for heating

Heating programmes control central heating operation. There are three modes for heating operation:

- **Comfort** ☀
- **Economy** ☾
- **Frost** (Frost protection) ❄

For each of those operating modes, there is a specified room temperature stored on the FW 100 heating controller (→ Section 6.2.2, page 38).

There are a total of three heating programme spaces (A to C) available for heating programmes. Each heating programme contains the switching times for one week (weekly programme).



Having several stored heating programmes simplifies changing from one heating programme to another, e.g. if your job involves periods when you work different shifts (night shift/day shift), or for holiday periods.

Menu: Heating > Programme

Use this menu to create, change or activate a heating program for each heating circuit.

The heating programmes are only active if the mode selector is set to **auto**.

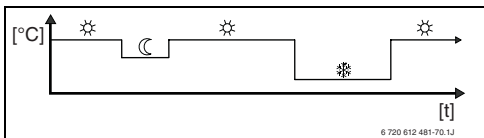

Fig. 18 Example of heating programme

- **Activate:** Selects and activates the heating programme.

For menu structure and adjustment ranges → page 32.

Menu: Heating > Programme > Edit

Use this menu if you want to adapt a heating programme with user defined time/temperature level profile to each heating circuit.

For menu structure and adjustment ranges → page 32.

Menu: Heating > Programme > Edit > A:Programme A ... C:Programme C

Use this menu to adapt the heating programme of your choice.

- **Copy from preset programme:** Overwrites the selected heating programme with an existing heating programme of your choice.
 - **A:Programme A ... C:Programme C:** Heating programmes with user-defined time/temperature profiles (programme names can be changed, see below).
 - **AM weekday worker ... Senior citizens:** Predefined heating programmes.
- **Reset factory settings:** Resets heating programme to default settings → page 25.
- **Programme name:** Changes name of heating programme using and . The 18 characters displayed can be individually replaced by selecting the letters and numbers offered.





To enter spaces:

- ▶ When the selected character is shown with a dark background, delete by pressing (space = _)

For menu structure and adjustment ranges → page 32.

Menu: Heating > Programme > Edit > A:Programme A ... C:Programme C > All days

Use this menu to set identical times for every day for the heating programme of your choice.

- **P1, P2 ... P6:** Maximum of six switching points per day and three different operating modes (**Comfort** ☀ / **Economy** ☾ / **Frost** ❄).
- The shortest switching interval is 15 minutes (= 1 segment).
- Deactivate switching points that are not required by deleting them.
- Skip switching points and operating modes that are not to be changed by pressing  or turning  the rotary selector.

For menu structure and adjustment ranges
→ page 32.

Menu: Heating > Programme > Edit > A:Programme A ... C:Programme C > Mon - Fri

Use this menu to set identical times for the days Monday to Friday for the heating programme of your choice.

- **P1, P2 ... P6:**
For explanation see **All days** above.

Menu: Heating > Programme > Edit > A:Programme A ... C:Programme C > Sat + Sun

Use this menu to set identical times for Saturday and Sunday for the domestic hot water programme of your choice.

- **P1, P2 ... P6:**
For explanation see **All days** above.

For menu structure and adjustment ranges
→ page 32.

Menu: Heating > Programme > Edit > A:Programme A ... C:Programme C > Monday, Tuesday ... Sunday

Use this menu to set different times for individual days in the heating programme of your choice (e.g. **Thursday**: starting the selected operating mode at the same time every Thursday).

- **P1, P2 ... P6:**
For explanation see **All days** above.



If the programming for, say, **Thursday** differs from the other weekdays, the options **All days** and **Mon - Fri** show ----- **from** ---:-- for all settings. In other words there are no common switching points and operating modes for all the days in those groups.

For menu structure and adjustment ranges
→ page 32.

Menu: Heating > Programme > View

- ▶ Shows switching points and associated operating modes for **All days**, **Mon - Fri**, **Sat + Sun** or the individual day of the week as a segment pattern.

For menu structure and adjustment ranges
→ page 32.

6.2.2 Temperature levels for operating modes and heating rate

Menu: Heating > Parameter

Use this menu to permanently set the temperature levels for the 3 operating modes (**Comfort** ☀ / **Economy** ☾ / **Frost** ❄) and the heating rate to suit your personal preferences and your home.

- **Heating up speed:** Use this menu item to set the required heating rate:
 - **Economy** = The building is heated up slowly, thus saving energy.
 - **Normal** = The building is heated up at the “normal” rate.
 - **Fast** = The building is heated up quickly, thus providing maximum comfort.

For menu structure and adjustment ranges

→ page 32.

Menu: Heating > Parameter > Heating levels

Use this menu to set the desired room temperature for each of the operating modes:

- **Comfort** ☀ = maximum required temperature (e.g. when the living areas are occupied and the occupants require a comfortable room temperature). Solid segments on the display indicate the period for which the operating mode is active.
- **Economy** ☾ = average required temperature (e.g. when a lower temperature is sufficient or when the home is empty or everyone is in bed and you do not want the house to cool down too much). Blank segments on the display indicate the period for which the operating mode is active.
- **Frost** ❄ = minimum required temperature (e.g. when the home is empty or everyone is in bed and it is OK for the house to cool down). Consider any pets and plants.

For menu structure and adjustment ranges

→ page 32.

6.3 DHW programme

Main menu: Domestic hot water



Set the domestic hot water temperature control on the boiler to the maximum required domestic hot water temperature.

• DHW and DHW circulation pump

You can use this menu option either to ...
... activate your own individual hot water programme (**Separate programmes**)

- or -

... associate the domestic hot water programme with your heating programme (**As heating programme**). That is useful if you frequently switch between different heating programmes. The domestic hot water programme is then automatically adapted to suit.

- **As heating programme** (Automatic mode together with heating programme):

With combination boiler:

Domestic hot water **On** as long as the heating system is in **Comfort** ☼ mode and for 1 hour afterwards (overrun time).
Otherwise domestic hot water **Off**.

With domestic hot water cylinder:

1 hour before the heating system switches to **Comfort** ☼ mode, the cylinder starts heating up to the set domestic hot water temperature (**Cylinder temp at heating level Comf.**¹⁾). This setting remains active as long as the heating system is in **Comfort** ☼ mode.

If the heating system is in **Economy** ☾ mode the cylinder is kept at the temperature set for **Cylinder temp at heating level Eco**¹⁾.

If the heating system is in **Frost** ❄ mode frost protection is also active for the domestic hot water cylinder (15 °C fixed value).

With DHW circulation pump for domestic hot water cylinder:

Circulation pump **On** and circulation pump cycles as per setting (→ Section 6.3.5 on page 44) if the heating circuit is running in **Comfort** ☼ mode.

Otherwise circulation pump **Off**

- **Separate programmes** (independent timer programmes):

Automatic switching between domestic hot water **On**²⁾ / **Off**²⁾ or different domestic hot water temperatures³⁾ and circulation pump **On** / **Off** according to the set programmes.

Circulation pump cycles as per setting (→ Section 6.3.5 on page 44).

For menu structure and adjustment ranges
→ page 33.

1) Setting domestic hot water temperature
→ Section 6.3.5 on page 44

2) Domestic hot water provided by combination boiler

3) Domestic hot water provided by domestic hot water cylinder

6.3.1 Domestic hot water programme operating modes

Domestic hot water programmes operate differently according to the type of hot water system:

- With combination boilers (boilers which produce domestic hot water instantaneously on demand) the hot water programme switches between the following operating modes:
 - **On:** if the Eco button on the boiler is not lit, domestic hot water is available very quickly on demand (Comfort mode). Solid segments on the display indicate the period for which the operating mode is active.
 - **Off:** the built-in plate heat exchanger in the boiler is not kept constantly hot (Eco mode); as a result energy is saved. In Eco mode, the hot tap has to be run for a short while before the water becomes hot. Blank segments on the display indicate the period for which the operating mode is active.
- With boilers connected to a domestic hot water cylinder, the hot water programme specifies the desired water temperature (specified temperature).
 - If the temperature measured in the domestic hot water cylinder is below the specified temperature, the cylinder is re-heated.
 - Once the specified temperature is reached (or exceeded), cylinder heating is stopped.



If the domestic hot water programme changes from a higher to a lower specified temperature, the water in the cylinder will not immediately cool to the lower temperature, i.e. water at a higher temperature will continue to be available for some time. However, the cylinder will not be reheated until the temperature falls below the new, lower specified temperature.



The segments on the display show the periods for the following domestic hot water temperature requirements:

- ≥ 50 °C – solid segments
 - ≤ 20 °C – no segments
 - other – blank segments
-

6.3.2 Timer programme for domestic hot water with combination boiler

Menu: Domestic hot water > DHW programme

Use this menu if you wish to use a timer programme for the domestic hot water. The timer programme is only programmable and active if **Domestic hot water > DHW and DHW circulation pump > Separate programmes** is set.

For menu structure and adjustment ranges
→ page 33.

Menu: Domestic hot water > DHW programme > Edit

Use this menu if you wish to adjust a timer programme for the domestic hot water.

- **Reset factory settings:** Resets domestic hot water programme to default settings
→ page 25.

For menu structure and adjustment ranges
→ page 33.

Menu: Domestic hot water > DHW programme > Edit > All days

Use this menu to set identical times for every day for the domestic hot water programme.

- **P1, P2 ... P6:** Maximum of six switching points per day and two different operating modes (**On / Off**).
 - **On:** if the Eco button on the boiler is not lit, domestic hot water is available very quickly on demand (Comfort mode).
 - **Off:** The heating system's heat exchanger is not heated (eco mode) as long as no water is drawn off. This saves energy. Domestic hot water is only available in eco mode after water has been drawn off for a while.
 - The shortest switching interval is 15 minutes (= 1 segment).

- Deactivate switching points that are not required by deleting them.

For menu structure and adjustment ranges
→ page 33.

Menu: Domestic hot water > DHW programme > Edit > Mon - Fri

Use this menu to set identical times for the days Monday to Friday for the domestic hot water programme.

- **P1, P2 ... P6:**
For explanation see **All days** above.

For menu structure and adjustment ranges
→ page 33.

Menu: Domestic hot water > DHW programme > Edit > Sat + Sun

Use this menu to set identical times for Saturday and Sunday for the domestic hot water programme.

- **P1, P2 ... P6:**
For explanation see **All days** above.

For menu structure and adjustment ranges
→ page 33.

Menu: Domestic hot water > DHW programme > Edit > Monday, Tuesday... Sunday

Use this menu to set different times for individual days in the domestic hot water programme.

- **P1, P2 ... P6:**
For explanation see **All days** above.

For menu structure and adjustment ranges
→ page 33.

Menu: Domestic hot water > DHW programme > View

- Shows switching points and associated operating modes for **All days, Mon - Fri, Sat + Sun** or the individual day of the week as a segment pattern.

For menu structure and adjustment ranges
→ page 33.

6.3.3 Time/temperature level program for domestic hot water via cylinder

Menu: Domestic hot water > DHW programme

Use this menu if you wish a domestic hot water programme with user-defined time/temperature profile.

The time/temperature programme is only programmable and active if **Domestic hot water > DHW and DHW circulation pump > Separate programmes** is set.

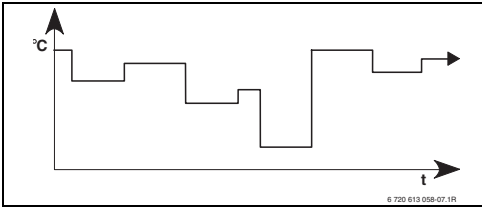

Fig. 19 Example domestic hot water programme with time/temperature profile

For menu structure and adjustment ranges
→ page 33.

Menu: Domestic hot water > DHW programme > Edit > All days

Use this menu to set identical times for every day for the domestic hot water programme.

- **P1, P2 ... P6:** Maximum of six switching points per day with individual temperature levels (**15 °C to 60 °C**).
 - The shortest switching interval is 15 minutes (= 1 segment).
 - Deactivate switching points that are not required by deleting them.

For menu structure and adjustment ranges
→ page 33.

Menu: Domestic hot water > DHW programme > Edit > Mon - Fri

Use this menu to set identical times for the days Monday to Friday for the domestic hot water programme.

- **P1, P2 ... P6:**
For explanation see **All days** above.

For menu structure and adjustment ranges
→ page 33.

Menu: Domestic hot water > DHW programme > Edit > Sat + Sun

Use this menu to set identical times for Saturday and Sunday for the domestic hot water programme.

- **P1, P2 ... P6:**
For explanation see **All days** above.

For menu structure and adjustment ranges
→ page 33.

Menu: Domestic hot water > DHW programme > Edit > Monday, Tuesday... Sunday

Use this menu to set different times for individual days in the domestic hot water programme.

- **P1, P2 ... P6:**
For explanation see **All days** above.

For menu structure and adjustment ranges
→ page 33.

Menu: Domestic hot water > DHW programme > View

- ▶ Shows switching points and associated temperatures for **All days, Mon - Fri, Sat + Sun** or the individual day of the week as a segment pattern.

For menu structure and adjustment ranges
→ page 33.

6.3.4 Timer programme for domestic hot water circulation pump (systems with domestic hot water cylinder only)

The circulation programme specifies when the circulation pump for domestic hot water circulation runs.

You can set up a circulation program for each DHW system.

Menu: Domestic hot water > DHW circ pump prog

Use this menu if you wish to use a timer programme for the domestic hot water circulation pump.

The timer programme is only programmable and active if **Domestic hot water > DHW and DHW circulation pump > Separate programmes** is set.

Menu: Domestic hot water > DHW circ pump prog > Edit > All days

Use this menu to set identical times for every day for the domestic hot water programme.

- **P1, P2 ... P6:** Maximum of six switching points per day and two different operating modes (**On / Off**).
 - **On:** Circulation pump cycles as per setting (→ Section 6.3.5 on page 44). Solid segments on the display indicate the period for which the operating mode is active.
 - **Off:** The circulation pump is stopped. Blank segments on the display indicate the period for which the operating mode is active.
 - The shortest switching interval is 15 minutes (= 1 segment).
 - Deactivate switching points that are not required by deleting them.

For menu structure and adjustment ranges
→ page 33.

Menu: Domestic hot water > DHW circ pump prog > Edit > Mon - Fri

Use this menu to set identical times for the days Monday to Friday for the domestic hot water programme.

- **P1, P2 ... P6:**
For explanation see **All days** above.

For menu structure and adjustment ranges
→ page 33.

Menu: Domestic hot water > DHW circ pump prog > Edit > Sat + Sun

Use this menu to set identical times for Saturday and Sunday for the domestic hot water programme.

- **P1, P2 ... P6:**
For explanation see **All days** above.

For menu structure and adjustment ranges
→ page 33.

Menu: Domestic hot water > DHW circ pump prog > Edit > Monday, Tuesday... Sunday

Use this menu to set different times for individual days in the domestic hot water programme.

- **P1, P2 ... P6:**
For explanation see **All days** above.

For menu structure and adjustment ranges
→ page 33.

Menu: Domestic hot water > DHW circ pump prog > View

- ▶ Shows switching points and associated operating modes for **All days, Mon - Fri, Sat + Sun** or the individual day of the week as a segment pattern.

For menu structure and adjustment ranges
→ page 33.

6.3.5 Parameters for domestic hot water

Menu: Domestic hot water > Parameter

- **Cylinder temp at heating level Comf.:**
This menu option is only active if **Domestic hot water > DHW programme > As heating programme** is set (→ Section 6.3.1 on page 40). This is where you set the desired domestic hot water temperature for your domestic hot water cylinder.
- **Cylinder temp at heating level Eco:**
This menu option is only active if **Domestic hot water > DHW programme > As heating programme** is set (→ Section 6.3.1 on page 40). This is where you set the desired reduced domestic hot water temperature for your domestic hot water cylinder.
- **DHW priority:** Use this menu if your heating is not to be switched off during cylinder heating (e.g. for buildings with limited insulation and low outdoor temperatures).
 - **Priority:** The heating is switched off during DHW heating.. The pumps stop and the mixers are closed.
 - **Conditional priority:** During DHW heating the heating circuits carry on heating, the pumps run and the mixers regulate to the desired temperature. The unmixed heating circuit is switched off to prevent overheating. Cylinder heating takes longer with **Conditional priority**
- **DHW circ pump cycles:**
This menu option is only active if the system has a domestic hot water circulation pump. The circulation pump stops during the circulation pump **Off** phases. This menu option specifies how many times per hour the circulation pump will cycle during the circulation pump **On** phase. With the setting:
 - **1 per hour to 6 per hour**, each circulation pump cycle lasts for 3 minutes.
 - **7 per hour**, the circulation pump runs continuously during the **On** phase.

For menu structure and adjustment ranges
→ page 33.

6.3.6 Thermal disinfection of domestic hot water

Menu: Domestic hot water > Thermal disinfection

This menu is only active if your domestic hot water is provided by a domestic hot water cylinder. We recommend that you carry out thermal disinfection at regular intervals. For larger domestic hot water systems, there may be a legal requirement for thermal disinfection. If you have a combination boiler, please refer to the guidance in the boiler documentation.



If the thermal disinfection function triggers the safety cut-out on the solar cylinder (HLC) the solar water heating is inactive. The controller indicates a fault (→ Section 9, page 66).



Warning: Risk of scalding

Domestic hot water can cause severe scalding.

- ▶ Only carry out thermal disinfection at times when the system is not normally in use.
- ▶ Inform occupants of the building of the danger of scalding and always monitor the thermal disinfection process.

• **Operating mode:**

- **Auto:** Thermal disinfection starts automatically according to the set starting conditions. The thermal disinfection can be switched on and cancelled manually.
- **Manual:** Thermal disinfection can be started from **Operating status**.

- **Operating status:**
 - **Not running:** No thermal disinfection in progress at present. Once-only thermal disinfection can be started by selecting **Start now**.
 - **Running:** Thermal disinfection currently in progress. Thermal disinfection can be stopped by selecting **Stop**.
If **Solar sys option E Thermal disinfection** is switched on (→ Section 8.4 on page 60) and thermal disinfection is stopped by selecting **Stop**, a fault is indicated for 5 minutes if the disinfection temperature in the solar cylinder has not been reached (Fault 54, → Section 9.1 starting on page 66).
- **Time:** Starting time for automatic thermal disinfection.
- **Time interval:** Period until next starting time for automatic thermal disinfection.



If you want to use automatic thermal disinfection (e.g. once a week), proceed as follows:

- ▶ Set the required time interval (e.g. 7d, i.e. 7 days).
- ▶ Set the required starting time (e.g. 22:00 hours).
- ▶ Set the operating mode **to Auto on the day** on which you want thermal disinfection to take place.

For menu structure and adjustment ranges
→ page 33.

6.4 General settings

6.4.1 Time, Date and Auto switch between GMT - BST

Menu: General settings > Time and date

Use this menu if you want to correct the date and time.

- **Time:** Resets the time, e.g. if the mains power has been off for more than 12 hours.
- **Date:** see above **Time**.
The day of the week (e.g. **Mo**) is automatically calculated.
- **Auto switch between GMT - BST:** Switches automatic summer/winter time adjustment on or off.
- **Time adjustment:** Sets the adjustment factor for the time. The adjustment is carried out once a week.

Example:

- If the time is out by approximately - 3 minutes a year
- - 3 minutes a year is equal to
 - 180 seconds a year
- 1 year = 52 weeks
- - 180 seconds ÷ 52 weeks
 - = - 3.46 seconds a week
- Correction factor = **+3.5sec/week**

For menu structure and adjustment ranges → page 35.

6.4.2 Display formats

Menu: General settings > Display format

Use this menu if you want to customise the display formats to suit your personal preferences.

- **Time:** Select format for time display between **12 am/pm** or **24h**.
- **Date:** Selects either **DD.MM.YYYY** or **MM/DD/YYYY** as date display format (D = number for

day, M = number for month, Y = number for year).

- **Display contrast:** Sets display contrast to between **25%** and **75%**.
- **Information at top of display:** Sets the desired information to be shown on the top line of the basic display.

For menu structure and adjustment ranges → page 35.

6.4.3 Key lock



For menu structure and adjustment ranges → page 35.

- **Key lock:** Use this menu option to prevent unwanted operation of the button functions, e.g. by children.
 - If a locked button is pressed when the **Key lock** is active and the screen is showing the basic display, an appropriate message appears.



If the mode selector is set to a different mode, it does not become active until the **Key lock** is cancelled.

► To cancel **Key lock**:

Press and hold  and  simultaneously until the relevant message appears.

For menu structure and adjustment ranges → page 35.

6.4.4 Language

- **Language:** Use this menu option if you want to set a different language for the display.

For menu structure and adjustment ranges → page 35.

6.5 Solar settings

Main menu: Solar

Use this menu if you want to limit the cylinder temperature or optimise the specified domestic hot water temperature and specified flow temperatures based on the available solar energy in your geographical region.

Limiting cylinder temperature(s)

In order to store as much solar energy as possible, a high cylinder temperature is required.

Limiting the cylinder temperature prevents overheating of the domestic hot water. The temperature setting is transmitted by the ISM module during commissioning.



Warning: Risk of scalding if the cylinder temperature is higher than 60 °C.

- ▶ If the cylinder temperature limit is set to > 60 °C, fit a thermostatic mixing valve in the hot water supply pipe.
- ▶ Set the thermostatic mixing valve to 60 °C max.

- **T2: Max. solar cylinder temperature:** Set cylinder temperature > 60 °C in systems with domestic hot water cylinders only if hot water outlet temperature is limited by a thermostatic mixing valve.

When using solar buffer cylinders, e.g. in solar preheat systems (solar system 3 and 4), **T2: Max. solar cylinder temperature** can be set higher.

For menu structure and adjustment ranges
→ page 35.

Solar optimisation

In order to use as much solar energy as possible, the FW 100 heating controller can estimate the

expected solar yield during the course of the day and take this into account in controlling the boiler. The boiler will then not be required to produce as much heat and will use less gas.

For more information for installers
→ Section 8.5.3 on page 62

- **Optimizing influence DHW:** Maximum reduction of specified domestic hot water temperature through solar input.

Example:

- Specified domestic hot water temperature = 60 °C
- **Optimizing influence DHW** = 15 K
- Specified domestic hot water temperature for the boiler = 60 °C – 15 K
- Provided there is sufficient solar output available, the maximum reduction is set and the boiler heats the domestic hot water to 45 °C, with the remaining 15 K being provided by the solar contribution.
- **CH circuit optimizing influence:** Influence of solar output on heat output that feeds into the heating circuit. At a high value, the preheat temperature of the heating curve is reduced at a correspondingly greater rate (further information for heating engineers → chapter 8.3 from page 56) to enable greater passive solar energy input through the building's windows. At the same time this reduces a temperature overshoot in the building and increases the comfort level.
 - **CH circuit optimizing influence** if the heating circuit heats rooms that have large areas of south-facing windows.
 - **CH circuit optimizing influence** if the heating circuit heats rooms that have small areas of north-facing windows.



Optimizing influence DHW and CH circuit optimizing influence do not start until a calibration phase of at least 30 days has been completed after commissioning of the solar thermal system. In that period, the FW 100 heating controller “learns” what level of solar yield is possible.

For menu structure and adjustment ranges
→ page 35.

7 Viewing information

Menu: INFO

This menu allows you to view a variety of system information.

Detailed instructions on navigating through the menu structure are provided in Section 5.2 starting on page 21.



The menu options are only shown if the system components are present and/or active and if there is no remote control access to them. Some menu options are not shown because they are switched off by a setting for another menu option.

INFO menu overview

The table below provides

- an overview of the menu structure (column 1). The menu level is indicated by different shades of grey. For example, the menus **Boiler** and **Heating system** are at the same level.
- an overview of the various display options (column 2).
- descriptions of the individual information items (column 3).



INFO menu structure	Display (example)	Description
Boiler	–	–
Outside temperature	10.0 °C	Current outside temperature.
Heating mode possible	Yes No	Shows whether boiler is ready for operation.
Current CH flow temperature	55.0 °C	Current boiler flow temperature.
Burner	On Off	Burner status.
Heating pump	On Off	Status of pump in the boiler.
Maximum CH flow temperature	75.0 °C	Maximum flow temperature set on the boiler.
Maximum domestic hot water temperature	60.0 °C	Maximum domestic hot water temperature set on the boiler.
Service required	Yes No	Shows whether a boiler service/inspection is due.

Tab. 12

Viewing information

INFO menu structure	Display (example)	Description
Heating system	–	–
Operating mode	Auto – Comfort Auto – Economy Auto – Frost Comfort Economy Frost Holiday – Auto Holiday – Comfort Holiday – Economy Holiday – Frost Floor drying waiting Floor drying running	Current operating mode for heating circuit 1.
Required room temp	25.0 °C	Room temperature provided by controller.
Current room temperature	22.0 °C	Room temperature measured at the controller (only with wall-mounted controller).
Required CH flow temperature	75.0 °C	Flow temperature for heating circuit 1 calculated and required by the controller.
Current CH flow temperature	47.0 °C	Flow temperature measured in heating circuit 1.
Heating pump	On Off	Heating pump switching status in heating circuit 1.
Current mixer setting	85% open	Current opening of mixer in heating circuit 1.
Domestic hot water	–	–
Operating mode	Immediate DHW Auto On Auto Off Holiday – Auto Holiday On Holiday Off	Current operating mode or special mode for domestic hot water with combination boiler.
	Immediate DHW Thermal disinfection Auto Holiday – Auto Holiday 15 °C	Current operating mode or special mode for domestic hot water cylinder.
Required DHW temperature	60.0 °C	Domestic hot water temperature required by controller.
Current DHW temperature	40.0 °C	Current measured domestic hot water temperature.
Domestic hot water status	Running Off	Current status of domestic hot water system.
Last thermal disinfection	Completed Cancelled Running	Status of last thermal disinfection.
Customer service		
Phone number	(Telephone number)	Telephone number of heating engineer (system installer).
Name	(Name)	Name of heating engineer (system installer).

Tab. 12

INFO menu structure	Display (example)	Description
Solar	–	–
Standard system	–	Menu for basic system component of solar thermal system.
T1: Temperature of collector group 1	80.0 °C	Temperature measured by collector temperature sensor (T ₁).
T2: Temp at bottom of solar cylinder	55.7 °C	Temperature measured by bottom cylinder temperature sensor (T ₂).
SP: Collector grp 1 solar pump status	Running Off	Status of solar pump (SP).
Collector group 1 shut down	Yes No	Shows whether safety shutdown of the solar pump (SP) due to overheating of the collectors (T ₁) has occurred.
Solar cylinder status	Fully charged Partially charged	Charge status of solar cylinder.
SP: Coll grp 1 solar pump running time	12463 h	Hours of duty of the solar pump (SP) since commissioning.
Thermal disinfection	–	Menu for thermal disinfection part of the system.
PE: Therm disinfect pump status	Running Off	Status of thermal disinfection pump (PE).
Temp diff controller		Menu for the freely available temperature differential controller
TF1: Heat source temperature	45.5 °C	Temperature measured at the heat source (TF1)
TF2: Heat consumer temperature	35.5 °C	Temperature measured at the heat sink (TF2)
PF/DWUF: Pump/valve status	On Off	Switching status of pump/valve in freely available temperature controller
Solar optimisation	–	Menu for solar-assisted optimisation of conventional heating system.
Solar yield in last hour	120 Wh	Solar energy yield in the last hour (a figure is only shown if correct parameters have been set on the Solar optimisation menu, →Section 8.5.3 on page 62).
Solar yield today	2.38 kWh	Solar energy yield for the current 24 hour period.
Solar yield overall	483.6 kWh	Total solar energy yield since commissioning.
DHW temperature reduced by	4.7 K	Current reduction of the specified domestic hot water temperature required by the boiler as a result of the available solar energy. Does not start until at least 30 days after commissioning.
Required room temperature reduced by	1.3 K	Current reduction of required room temperature for heating circuit based on available solar energy. Does not start until at least 30 days after commissioning.
Faults	40 Solar system 03 FW 100 EA Boiler ...	List of current faults. More detailed information can be obtained by selecting with the rotary selector  and then pressing the rotary selector  to confirm.

Tab. 12

8 INSTALLER SETTINGS menu settings (for installers only)



The **INSTALLER SETTINGS** menu is intended only for installers.

- ▶ To open **INSTALLER SETTINGS**: press and hold  for approx. 3 seconds.

Detailed instructions on navigating through the menu structure, programming, deleting settings and resetting to the default settings are provided in Section 5.2 starting on page 21.

8.1 INSTALLER SETTINGS menu summary and settings

The tables set out below provide

- an overview of the menu structure (column 1).
The menu level is indicated by different shades of grey.
For example, on the menu **Solar sys parameters**, the submenus **1. Standard system** and **Solar optimisation** are at the same level.
- an overview of the default settings (column 2), e.g. for the purposes of resetting individual menu options to the default.
- an overview of the adjustment ranges of the individual menu options (column 3).
- space for making a note of your personal settings (column 4).
- references to the detailed descriptions of the individual menu options (column 5).



The menu options are only shown if the system components are present and/or active and if there is no remote control access to them. Some menu options are not shown because they are switched off by a setting for another menu option.

- ▶ Always set or skip menu options in order. In that way, subsequent menu options will be automatically adjusted or not shown.

8.1.1 INSTALLER SETTINGS: System configuration

System configuration menu structure	Default setting	Setting range	Personal setting	Description starts on page
Start automatic system configuration	No	No Yes		56
Domestic hot water configuration	Combi boiler	No Combi boiler Cyl conn to boiler Cyl on IPM ident. 3 ... 10		
CH system configuration	Unmixed without IPM	No Unmixed without IPM Unmixed with IPM Mixed		
DHW circulation pump	No	No Present		
ISM 1	No	No Present		

Tab. 13
8.1.2 INSTALLER SETTINGS: Heating parameters

Heating parameters menu structure	Default setting	Setting range	Personal setting	Description starts on page
Heating circuit type	Radiators	Foot point/End point Underfloor heating Radiators Convectors		64
Foot point	25 °C	10 °C ... 85 °C	°C	
End point	75 °C	30 °C ... 85 °C	°C	
Design flow temp.	75 °C	30 °C ... 85 °C	°C	
Maximum CH flow temperature	80 °C	30 °C ... 85 °C	°C	
Room influence	30%	0% ... 100%	%	
Room influence enabled for levels	Eco/Frost	Eco/Frost Comfort/Eco/Frost		
Room temperature offset	0.0 K	- 5.0 K ... 5.0 K	K	
Heating off until lower level reached	Yes	No Yes		
Heating off at outside temperature	20.0 °C	10.0 °C ... 25,0 °C, 99,0 °C (= Function off)	°C	
Freezing risk at outside temperature	3.0 °C	- 5.0 °C ... 10.0 °C	°C	
Mixer running time	140 s	10 s ... 600 s	s	
Minimum outside temperature	- 15 °C	- 30 °C ... 0 °C	°C	
Building storage capacity	50%	0% ... 100%	%	
Calibrate internal room temp sensor	0.0 K	- 3.0 K ... 3.0 K	K	

Tab. 14
8.1.3 INSTALLER SETTINGS: Solar system config

Solar system config menu structure	Default setting	Setting range	Personal setting	Description starts on page
Solar sys option E Thermal disinfection	No	No Yes		60

Tab. 15

INSTALLER SETTINGS menu settings (for installers only)

8.1.4 INSTALLER SETTINGS: Solar sys parameters

Solar sys parameters menu structure	Default setting	Setting range	Personal setting	Description starts on page
1. Standard system	–	–	–	61
SP: ON temperature difference	8 K	3 K ... 20 K (not lower than "SP: OFF temperature difference" +1 K)	K	
SP: OFF temperature difference	4 K	2 K ... 19 K (not higher than "SP: ON temperature difference" – 1 K)	K	
T2: Max. solar cylinder temperature	60 °C	15 °C ... 90 °C	°C	
Maximum collector temperature	120 °C	100 °C ... 140 °C	°C	
SP: Collector grp 1 pump mode	Auto	Auto Manual On Manual Off		
PE: Therm disinfect pump mode	Auto	Auto Manual On Manual Off		60
Solar optimisation				62
Collector group 1 area	0.0 m ²	0.0 m ² ... 150.0 m ²	m ²	
Collector group 1 type	Flat plate collector	Flat plate collector Vac tube collector		
Climate zone	90	0 ... 255		
Optimizing influence DHW	0 K	0 K (= function off) ... 20 K	K	
CH circuit optimizing influence	0.0 K	0.0 K (= function off) ... 5.0 K	K	
Run solar system	No	No Yes		

Tab. 16

8.1.5 INSTALLER SETTINGS: Fault history

Fault history menu structure	Default setting	Setting range	Personal setting	Description starts on page
01/01/2008 16:11 Fault EA (example of last fault)	–	–	–	64
09/25/2008 18:45 FAULT 44 - IPM IDENT. 10 (up to maximum of 19 past faults)	–	–	–	

Tab. 17

8.1.6 INSTALLER SETTINGS: Cust service address

Cust service address menu structure	Example	Setting range	Personal setting	Description starts on page
Telephone number	012345 6789	Max. 20 characters		64
Name	Heating installer	Max. 20 characters		

Tab. 18

8.1.7 INSTALLER SETTINGS: System info

System info menu structure	Example	Setting range	Personal setting	Description starts on page
Installation date	10/22/2008 (activated on commissioning)	-	-	64
Boiler part number	7 777 777 777 (data from boiler)	-	-	
Boiler date of manufacture	06/27/2008 (data from boiler)	-	-	
Controller part number and model	7 777 777 777 FW 100 (fixed factory setting)	-	-	
Controller date of manufacture	06/27/2008 (fixed factory setting)	-	-	
Controller software version	JF11.12 (fixed factory setting)	-	-	

Tab. 19

8.1.8 INSTALLER SETTINGS: Floor drying

Floor drying menu structure	Default setting	Setting range	Personal setting	Description starts on page
Cancel floor drying ¹⁾	No	No Yes		65
Maximum CH flow temperature	25 °C	25 °C ... 60 °C	°C	
Maintain max CH flow temp for	1 days	1 day ... 20 days	d	
Total floor drying time	calculated	calculated... 60 d(not less than "Maintain max CH flow temp for")	-	
Start date	- - . - - . - - - -	Today ... 31/12/2099 (in increments of one day/month/year)		
Start time	- - : - -	00:00 ... 23:59 (in increments of one hour/minute)		

Tab. 20

1) Only available if "Floor drying" is active.

8.2 Configuring the heating system

Installer settings: System configuration



An example system configuration is shown in Section 2.6 on page 11.

Use this menu if you want to configure the system automatically or manually, e.g. when commissioning or making changes to the system.

- **Start automatic system configuration** for starting automatic configuration.
- **Domestic hot water configuration** for configuring the domestic hot water system manually.
- **CH system configuration** for configuring the heating system manually.
- **DHW circulation pump**: This menu option is only active if the domestic hot water system has a domestic hot water circulation pump.

When first commissioning a heating system, proceed as follows:

- ▶ Start automatic configuration.
- ▶ Check the other menu options under **System configuration** and, if necessary, adjust to suit the present system.



The heating system's solar thermal system must be configured manually (→ Section 8.4, page 60). Automatic configuration of the heating system does not configure the solar system.

For menu structure and adjustment ranges → page 53.

8.3 Parameters for heating

Installer settings: Heating parameters



Set the flow temperature control on the boiler to the maximum required flow temperature.

Use this menu if you want to set the parameters for the heating circuit controlled by the FW 100 controller. For example, the heating curves can be calculated with these parameters.

Installer settings: Heating parameters

- **Heating circuit type**: Use this menu item to set the heating type:
 - **Foot point/End point**: Default settings for a level heating curve are used according to the classic foot point/end point method.
 - **Underfloor heating**: Default settings for an uneven heating curve as in an underfloor heating circuit are used.
 - **Radiators**: Default settings for an uneven heating curve as in a radiator heating circuit are used.
 - **Convectors**: Default settings for an uneven heating curve as in a convector heating circuit are used.



Parameters not used in a particular type of heating are not shown.

For menu structure and adjustment ranges → page 53.

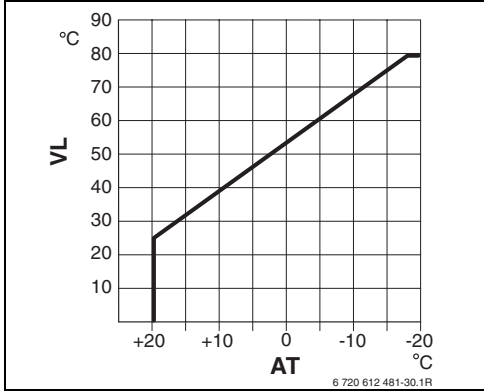

Fig. 20 Default setting of heating curve for foot point/end point

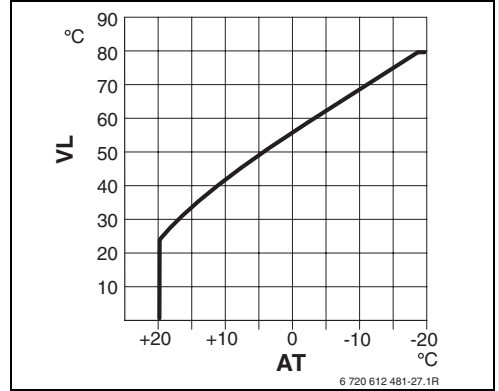

Fig. 22 Default setting for heating curve in radiator heating system

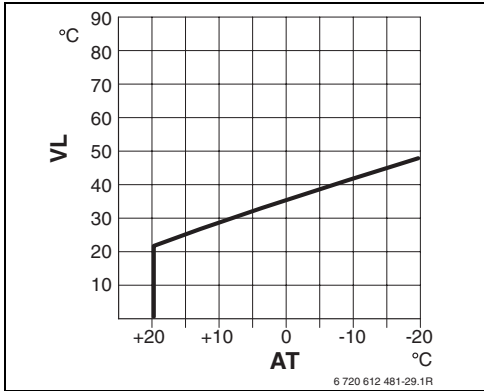

Fig. 21 Default setting for heating curve in underfloor heating

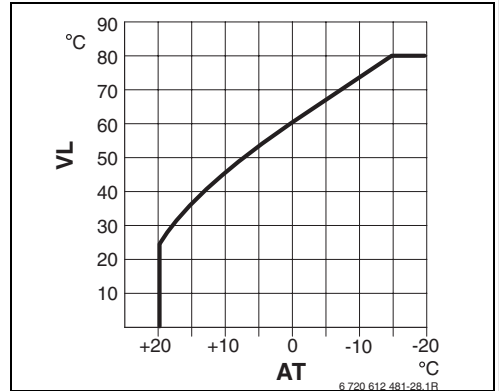

Fig. 23 Default setting for heating curve in convector heating system

AT Outside temperature

VL Flow temperature

Default setting of parameters for heating curve	Foot point/End point	Underfloor heating	Radiators	Convectors
Heating surface exponent (fixed value), curvature of heating curve	-	1.1	1.3	1.4
Minimum outside temperature	-	- 15 °C	- 15 °C	- 15 °C
Foot point	25 °C	-	-	-
End point	75 °C	-	-	-
Design flow temp.	-	45 °C	75 °C	80 °C
Maximum CH flow temperature	80 °C	55 °C	80 °C	80 °C
Room temperature offset	0.0K	0.0K	0.0K	0.0K
Heating off at outside temperature	20 °C	20 °C	20 °C	20 °C

Tab. 21

- **Foot point:** Use this menu item to set the base point of the heating curve according to the traditional foot point/end point method.
- **End point:** Use this menu item to set the end point of the heating curve according to the traditional foot point/end point method.
- **Design flow temp.:** Use this menu item to adapt the flow temperature setting to the heating type:
 - For **Underfloor heating** e.g. 45 °C flow temperature setting.
 - For **Radiators** e.g. 75 °C flow temperature setting.
 - For **Convectors** e.g. 80 °C flow temperature setting.
- **Maximum CH flow temperature:** Use this menu item to adapt the maximum flow temperature setting to the heating type:
 - For **Underfloor heating** e.g. 55 °C maximum flow temperature setting.
 - For **Radiators** e.g. 80 °C maximum flow temperature setting.
 - For **Convectors** e.g. 80 °C maximum flow temperature setting.
- **Room influence:** This menu item only appears if the controller is wall-mounted. Use this menu item to set the room temperature influence on the heating curve:
 - **0%:** No room temperature influence
 - **100%:** Maximum room temperature influence
- **Room influence enabled for levels:** Use this menu item to select the operating modes where the room temperature influence is to be active:
 - **Eco/Frost:** Room temperature influence is only active in these operating modes.
 - **Comfort/Eco/Frost:** Room temperature influence is always active.
- **Room temperature offset:** Use this menu item to set the permanent increase in required room temperature, e.g. to correct system-related variations.
- **Heating off until lower level reached:** Use this menu item to select the cooling down phase:
 - **No:** Heating mode corresponds to the heating curve.
 - **Yes:** Heating mode corresponds to the heating curve but without heating in the cooling down phase. Only at the point when the room temperature reaches the required room temperature for the next lower operating mode for the first time (e.g. **Economy** with 15,0 °C) does the heating correspond to this operating mode.
- **Heating off at outside temperature:** Use this menu item to set the outside temperature at which the heating is to switch off:
 - **10 °C ... 25 °C:** Outside temperature at which heating switches off.
 - **99 °C:** Function switched off, i.e. the heating can switch on at any outside temperature.
- **Freezing risk at outside temperature:** Use this menu item to set the frost threshold temperature at which the heating is to switch on:
 - If the outside temperature exceeds the set frost threshold temperature by 1 K (°C) and there is no heat demand then the heating pump in the heating circuit switches off.
 - If the outside does not exceed the frost threshold temperature then the heating pump in the heating circuit switches on (system Frost protection).



Warning: Domestic hot water pipe-work may freeze if the frost threshold is set too low and long periods of outside temperatures below 0 °C are experienced.

- ▶ Default setting of the frost threshold (3 °C) must only be adjusted by an installer.
- ▶ Don't set the frost threshold too low.

Damage caused by the frost threshold being set too low is not covered by the warranty.

- ▶ Position a precision instrument near FW 100. The precision instrument must not transfer any heat to the FW 100.
- ▶ Keep away from heat sources such as sunlight, body heat, etc. for 1 hour.
- ▶ Determine the displayed temperature differential ($T_{\text{Reference}} - T_{\text{FW 100}}$) and set as correction value.

For menu structure and adjustment ranges

→ page 53.

- **Mixer running time:** Use this menu item to set the **Mixer running time** to the runtime of the mixer motor used.

For menu structure and adjustment ranges

→ page 53.

- **Minimum outside temperature:** Set the minimum outside temperature to UK standards (as for heat loss calculations).

Typically -1 °C to -3 °C.

This provides an optimized heatcurve to UK conditions.

Further reference is available in BS5449:1990 - Specification for forced circulation hot water central heating systems for domestic premises.

- **Building storage capacity:** Use this menu item to set the factor for the heat storage capacity of the building.

- ≥ **50%**: Building of solid construction (e.g. stone house with thick walls).

- ≤ **50%**: Building of light construction (e.g. weekend house made of wood).

- **Calibrate internal room temp sensor:** This menu item only appears if the controller is wall-mounted.

Use this menu item if you want to correct the displayed room temperature.

8.4 Configuring the solar thermal system



The heating system's solar thermal system has to be configured manually. Automatic configuration of the heating system (→ Section 8.2, page 56) does not configure the solar system.

Installer settings: Solar system config



An example system configuration is shown in Section 2.6 on page 11.

Use this menu if you want to configure the solar heating system, e.g. at start-up or when changing the system.

- **Solar sys option E Thermal disinfection** for thermal disinfection

For menu structure and adjustment ranges → page 53.

8.5 Parameters for solar thermal system



Fill and bleed the solar thermal system according to its documentation and prepare it for commissioning as described this Section.

Installer settings: Solar sys parameters

The default parameter settings on this menu are suitable for many common system dimensions. Use this menu if you want to finely adjust the parameters to suit the installed solar thermal system.



The designations of the pumps and the temperature sensors, e.g. (PE) or (T1), are also used in the ISM installation instructions.

8.5.1 Commissioning the solar thermal system

Installer settings: Solar sys parameters

Before commissioning the solar thermal system you must:

- ▶ Fill and bleed the solar thermal system.
- ▶ Check the parameters for the solar thermal system and, if necessary, finely adjust them to suit the installed system.

PE: Therm disinfect pump mode: Use this menu item to select the operating mode of the pump (PE) for the thermal disinfection process.

- **Auto:** Automatically controlled operation according to the set parameters.
- **Manual On:** Switches the pump permanently on (e.g. for function test when commissioning).
- **Manual Off:** Switches the pump permanently off (e.g. for servicing work on the pump without having to interrupt heating operation).
- **Run solar system:** Use this menu option to commission the solar thermal system.
 - **Yes:** Solar thermal system is active. The ISM control outputs are enabled for automatic control purposes.
 - **No:** Solar thermal system is not active. The ISM control outputs are disabled for automatic control purposes but can be switched on manually.

For menu structure and adjustment ranges → page 54.

8.5.2 Parameters for the standard solar thermal system

Menu: Solar sys parameters > 1. Standard system

Use this menu to set the parameters for the solar thermal system if you are using it to provide domestic hot water.

- **SP: ON temperature difference:** Use this menu option to set the cut-in temperature differential for the solar pump (SP).
If the difference between the collector temperature (T_1) and the solar cylinder temperature (T_2) rises above the set figure, the solar pump (SP) is switched on.
- **SP: OFF temperature difference:** Use this menu option to set the cut-out temperature differential for the solar pump (SP).
If the difference between the collector temperature (T_1) and the solar cylinder temperature (T_2) drops below the set figure, the solar pump (SP) is switched off.
- **T2: Max. solar cylinder temperature:** For a detailed description of **T2: Max. solar cylinder temperature** → page 47.
- **Maximum collector temperature:** Use this menu option to set the maximum temperature at the collector temperature sensor (T_1).
If the temperature detected at the collector sensor (T_1) rises above the set figure, operation of the solar pump (SP) is disabled until the temperature drops back below the set figure.

- **SP: Collector grp 1 pump mode:** Use this menu option to set the operating mode for the solar pump (SP).
 - **Auto:** Automatically controlled operation according to the set parameters.
 - **Manual On:** Switches the pump permanently on (e.g. for bleeding the solar system when commissioning).
 - **Manual Off:** Switches the pump permanently off (e.g. for servicing work on the solar system without having to interrupt heating operation).

For menu structure and adjustment ranges → page 54.



At temperatures above 140 °C and system pressures < 4 bar, the heat transfer fluid in the collector evaporates. The solar pump remains disabled until the collector has cooled to a temperature at which there is no more vapour in the solar circuit.

8.5.3 Parameters for solar optimisation

Solar optimisation is performed automatically according to the available solar output. Calculation of the solar output requires specification of the installed collector area, the collector type and the climate zone in which the system is installed.

Menu: Solar sys parameters > Solar optimisation

Use this menu to set the parameters for solar optimisation.

- **Collector group 1 area:** Use this menu option to set the installed collector area for collector group 1.

Collector type	Gross area per collector in m ²
FK 210	2.1
FK 240	2.4
FK 260	2.6
VK 180	1.8
FKT-1	2.4
FKC-1	2.4
FKB-1	2.4

Tab. 22 Gross collector areas

- **Collector group 1 type:** Use this menu option to set the installed collector type for collector group 1.
- **Climate zone:** Use this menu option to set the climate zone number for the geographical region in which the system is located.
 - Find the location of your system on the climate zones map (→ Fig. 24) and enter the climate zone number.
 - If your location is not shown on the map, leave the number as it is (default setting is 90).
- **Optimizing influence DHW:** This parameter can also be set on the main menu under **Solar**. A detailed description can be found on page 47.
- **CH circuit optimizing influence:** This parameter can also be set on the main menu under **Solar**. A detailed description can be found on page 47.

For menu structure and adjustment ranges
→ page 54.

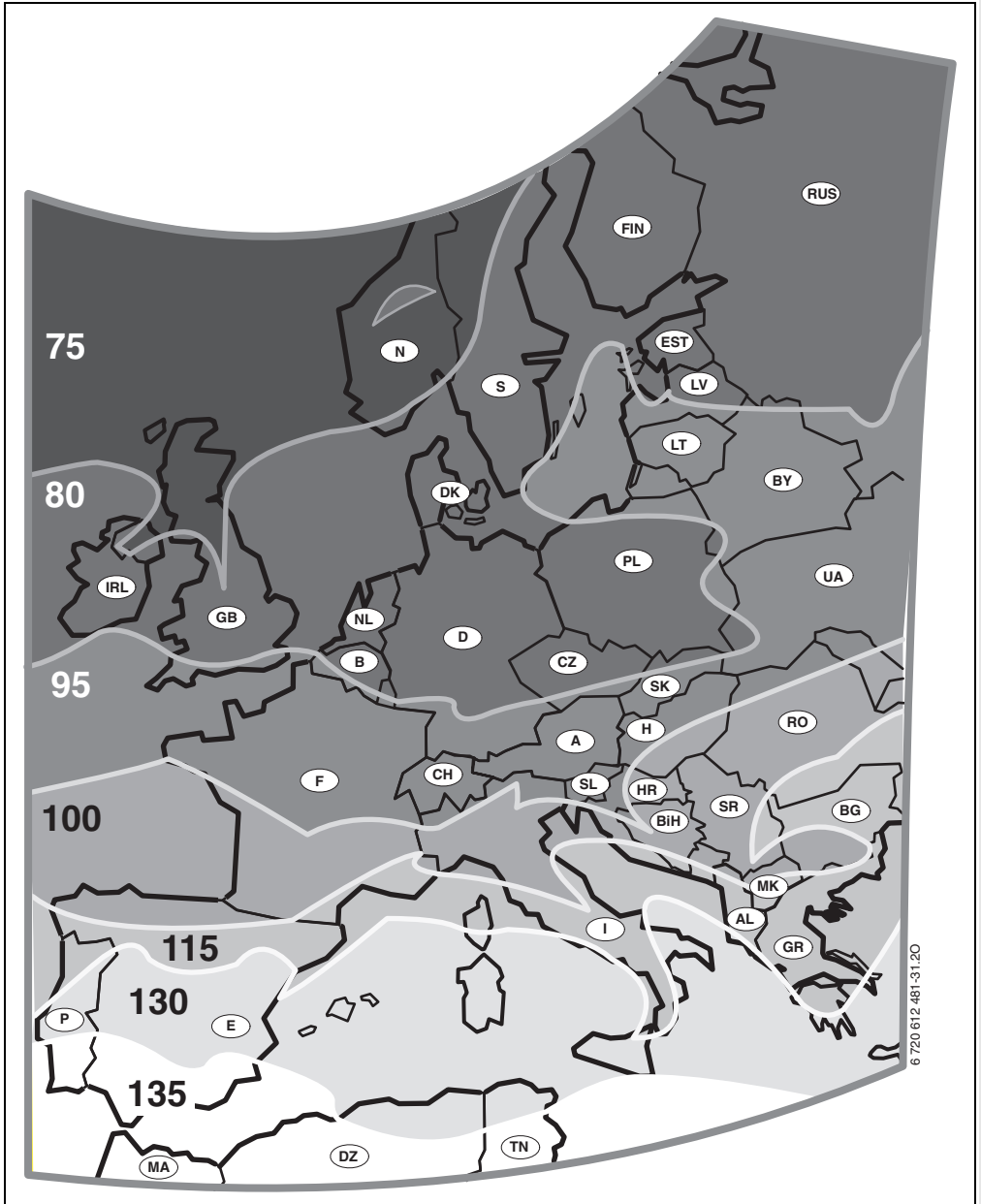

Fig. 24 Map of climate zones in Europe

8.6 Fault history

Installer settings: Fault history

Installers can use this option to view the last 20 faults that have occurred on the system (fault date, source, code and description). The faults shown first may still be active.

For menu structure → page 54.

8.7 Viewing and entering the customer service address

Installer settings: Cust service address

- **Phone number:** The installer can enter the phone number to call for customer service here.
- **Name:** The installer can enter the address of the heating installer responsible for customer service here.



To enter spaces:

- ▶ When the selected character is shown with a dark background, delete by pressing  (space = _)

For menu structure and adjustment range
→ page 54.

8.8 Viewing system information

Installer settings: System info

Shows a variety of system information:

- **Installation date**
(automatically activated on commissioning)
- **Boiler part number**
(fixed setting from boiler)
- **Boiler date of manufacture**
(fixed setting from boiler)
- **Controller part number and model**
(fixed factory setting)
- **Controller date of manufacture**
(fixed factory setting)
- **Controller software version**
(fixed factory setting)

For menu structure → page 55.

8.9 Screed drying function

Installer settings: Floor drying

The screed drying function allows fresh screed on underfloor heating to be dried in accordance with the screed manufacturer's instructions. All mixed heating circuits are heated up equally.



Warning: Risk of damaging or destroying the screed.

- ▶ With multi-circuit systems this function can be used in combination with a mixed heating circuit.
- ▶ Program screed drying function in accordance with screed manufacturer's instructions.
- ▶ In spite of the screed drying function, visit the system daily and make the prescribed reports.



DHW heating is not possible from programming to completing the screed drying function.

Menu: Floor drying

- **Cancel floor drying:** If the screed drying function is activated, the function can be switched off with **Yes**.
- **Maximum CH flow temperature:** Enter the maximum flow temperature (1) for the screed drying function here.
- **Maintain max CH flow temp for:** Enter the timescale (2) here of when the maximum flow temperature should be maintained.
- **Total floor drying time:**
 - The minimum total duration (3) is automatically calculated by the heating controller. This is based on a rise of flow temperature of a maximum 10 K (°C) per day.

- A higher value must be entered for the whole duration (3) if the screed cannot bear this increase. This produces a corresponding reduction in the daily increase.
- The first stage and the last stage of the flow temperature is 25 °C (fixed value).

Example:

Maximum flow temperature (1) = 50 °C

Duration of maximum flow temperature (2) = 7 days

Max. increase/decrease in temperature per day = 5 K

$$2d \times \frac{(50^{\circ}\text{C} - 25^{\circ}\text{C})}{5\text{K}} + 7d = 17d$$

Total duration of screed drying (3) = 17 days

- **Start date:** Enter the start date of the screed drying here.
- **Start time:** Enter the start time of the screed drying here.

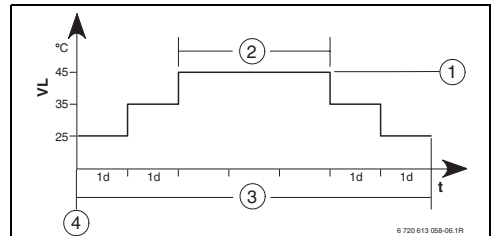

Fig. 25

- 1d** 1 day
- 1** Maximum flow temperature
- 2** Duration of max. flow temperature
- 3** Total duration of screed drying
- 4** Start date and start time
- t** time
- VL** Flow temperature

For menu structure and adjustment range → page 55.

9 Troubleshooting

BUS device faults are indicated.

If the controller shows Fault 12, the cylinder temperature is so high that the cylinder HLC has tripped.

- ▶ Reset the HLC.

If the appliance frequently cuts out in this way,

- ▶ Telephone your approved installer or Customer Service for assistance, providing details of the fault and the appliance.

A fault on the boiler (e.g. Fault EA) is shown on the controller display together with a corresponding message.

- ▶ Contact your installer.



For installer:

- ▶ Rectify the fault in accordance with the details in the boiler documentation.

9.1 Troubleshooting using the display (for installers only)

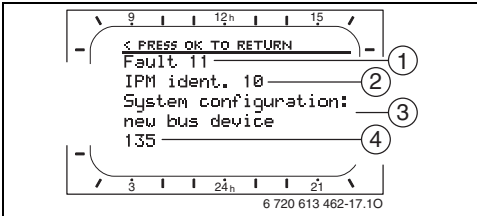

Fig. 26 Fault display

- 1 Fault number
- 2 BUS device which detected the fault and reported it to the controller
- 3 Description of fault
- 4 Code or additional information about fault

The current fault is displayed on the controller:

- ▶ Identify the BUS device affected by the current fault. The fault can only be rectified on the BUS device from which the fault originates.

Information displayed (→ Pos. 1, 3 and 4 in fig. 26)			
Text	Code	Cause	Remedy (by installer)
Fault 01 BUS communication fault	200	Boiler no longer reporting.	Check BUS device, BUS connection and repair circuit break if necessary.
	201	Incorrect BUS subscriber connected.	Identify and replace incorrect BUS device.
Fault 02 Internal fault	42	Code switch on IPM in intermediate position.	Switch system off and correct coding.
	43	Coding switch position has been changed since initialisation phase.	
	100	ISM not responding.	Check BUS connection and repair circuit break if necessary.

Tab. 23

Information displayed (→ Pos. 1, 3 and 4 in fig. 26)			
Text	Code	Cause	Remedy (by installer)
Fault 02 Internal fault Some parameters reset to factory settings due to EEPROM problem	205	Some parameters reset to default.	Check parameter settings and readjust them as necessary. Replace faulty controller.
Fault 02 Internal fault FW 100 can no longer control the heating system!	255	FW 100 can no longer control the heating system.	Replace faulty controller.
Fault 03 Room temp sensor faulty	20	There is a circuit break on the room temperature sensor built into the FW 100.	Replace faulty controller.
	21	There is a short circuit on the room temperature sensor built into the FW 100.	
Fault 11 System configuration: new BUS device New ISM detected. Power up all ISMs simultaneously and start automatic system configuration.	131 132	New ISM detected.	Power up all ISMs simultaneously and start automatic system configuration.
Fault 12 System configuration: BUS device missing ISM1 not detected. Check connection.	170 171	HLC has tripped or is faulty.	Check HLC. Check solar parameter T2 (→ Section 6.5, page 47). Is thermal disinfection active?
		ISM1 no longer detected despite having been configured.	Check connection.
Fault 13 System configuration: BUS device changed or replaced Check system configuration for DHW or start automatic system configuration.	157	BUS device changed or replaced.	Check system configuration for domestic hot water system or start automatic system configuration.
			Check system configuration for heating circuit
Fault 13 System configuration: BUS device changed or replaced Check system configuration for heating circuit!	158 159		
Fault 15 Outside temperature sensor not connected Outside temperature is not available.	30	Outside temperature sensor not recognised.	Check outside temperature sensor and remedy interruption, if necessary.
Fault 19 Unable to save parameter settings	202	BUS device is configured but not available at present.	Check system layout, check system configuration, modify if necessary and set parameter again.
Fault 20 System configuration: invalid	193	Invalid coding in remote control for the heating circuit.	In combination with FW 100 only coding 1 is possible in the remote control.
Fault 27 FW100 not found!	191	Remote control cannot detect heating controller FW 100.	Check Bus connection.

Tab. 23

Troubleshooting

Information displayed (→ Pos. 1, 3 and 4 in fig. 26)			
Text	Code	Cause	Remedy (by installer)
Fault 29 Unable to save parameter settings	202	BUS device is configured but not available at present.	Check system layout, check system configuration, modify if necessary and reset parameters on remote control.
Fault 30 Mixer temperature sensor faulty	7	Mixer temperature sensor (MF) connected to IPM faulty.	Check mixer temperature sensor (MF) and replace if necessary.
Fault 33 Temperature sensors incorrectly connected	22	A temperature sensor is connected to the IUM.	Remove the temperature sensor and insert a coding plug if necessary.
Fault 40 Temperature sensor T1 on collector group 1 faulty	101	Short circuit on the sensor lead (T ₁).	Check temperature sensor (T ₁) and replace if necessary.
	102	Break in the sensor lead (T ₁).	
Fault 41 Temperature sensor T2 at bottom of solar cylinder faulty	103	Short circuit on the sensor lead (T ₂).	Check temperature sensor (T ₂) and replace if necessary.
	104	Break in the sensor lead (T ₂).	
Fault 50 Solar pump jammed or air in system	121 126 140	Solar pump (SP) sticking due to physical blockage.	Unscrew and remove the slotted screw on the pump head and use a screwdriver to release the pump shaft. Do NOT strike the pump shaft with the screwdriver.
		Air in solar thermal system.	Bleed solar system and top up with heat transfer fluid if necessary.
Fault 51 Incorrect temperature sensor type connected	122	Collector temperature sensor type used as cylinder temperature sensor (T ₂).	Use correct type of temperature sensor. → Technical data in ISM installation instructions.
	123	Cylinder temperature sensor type used as collector temperature sensor (T ₁)	
	127	Cylinder temperature sensor type used as collector temperature sensor (TA).	
	132	Temperature sensor type PTC 1000 used as cylinder temperature sensor (T ₂).	
	133	Temperature sensor type PTC 1000 used as collector temperature sensor (T ₁).	
Fault 52 Temperature sensors reversed	124	Temperature sensors (T ₁ and T ₂) reversed.	Check the temperature sensors and swap the connections if necessary.
Fault 53 Temperature sensor fitted in wrong location	125	Collector temperature sensor (T ₁) fitted on collector array inlet.	Fit collector temperature sensor (T ₁) close to collector array outlet.
	128		

Tab. 23

Information displayed (→ Pos. 1, 3 and 4 in fig. 26)			
Text	Code	Cause	Remedy (by installer)
Fault 54 Temperature for thermal disinfection not reached in solar cylinder	145	Maximum temperature for solar cylinder too low.	Set maximum temperature for the solar cylinder higher → limit cylinder temperature, page 49.
		Delivery rate of disinfection pump (PE) too low.	Set higher pump speed on disinfection pump (PE) or, if possible, open flow restrictor more.
		Thermal disinfection cancelled manually before the required temperature was reached in the solar cylinder.	This is not a fault. Message is shown only for 5 minutes.
Fault 55 Solar system not yet commissioned	146	Solar system is not yet in operation.	Fill, bleed and prepare the solar thermal system for commissioning according to its documentation. Then start up the solar system.
Fault 56 At least one pump/valve in manual mode	147	Pump (SP) in manual mode.	Reset parameters for pump or valve to "Auto".
	154	Pump (PE) operated manually.	
Fault 59 Mass flow rate in solar system too high/low.	201	Mass flow rate in solar system for collector group 1 is too high.	Set mass flow in solar system correctly (e.g. increase/decrease pump speed) and if necessary open or close flow restrictor more on solar station. Guide figure: 20 - 40 kg/m ² of collector area per hour. Check setting for collector area, type and climate zone on Solar optimisation menu.
	202	Mass flow rate in solar system for collector group 1 is too low.	

Tab. 23

9.2 Troubleshooting without using the display

Fault	Cause	Remedy
Required room temperature not achieved.	Thermostatic valve(s) set too low.	Set thermostatic valve(s) higher.
	Minimum outside temperature setting too low.	Ask your installer to adjust minimum outside temperature setting (→ page 59)
	Heating curve set too low.	“Heating levels” for “Comfort” or ask your installer to correct heating curve.
	Flow temperature controller on the boiler set too low.	Set the flow temperature controller higher.
		Reduce influence of solar optimisation if necessary.
	Air in the heating system.	Bleed radiators and vent the heating system.
	Room temperature offset set incorrectly	Perform adjustment to room temperature sensor (→ page 59) and correct Room temperature offset (→ page 58)
The boilers holiday function is active.	Deactivate the boilers holiday function.	
Heating up takes too long.	“Heating up speed” set too low.	Set “Heating up speed” e. g. to “Fast”.
Flow temperature from boiler too low, radiators too cool.	Minimum outside temperature setting too low.	Ask your installer to adjust minimum outside temperature setting (→ page 59)
Required room temperature greatly exceeded.	Radiators become too hot.	Set thermostatic valve(s) lower. “Heating levels” for “Comfort” or ask your installer to correct heating curve.
	FW 100 installed in an unfavourable location, e.g. external wall, near windows, in a draught,	Select a better location for FW 100 and ask your heating engineer to reposition it.
	Room temperature offset set incorrectly	Perform adjustment to room temperature sensor (→ page 59) and correct Room temperature offset (→ page 58)
Excessive room temperature fluctuations.	Temporary influence of external heat on the room, e.g. through solar radiation, lighting, TV, fireplace etc.	Ask your installer to increase “Room influence”.
		Select a better location for FW 100 and ask your heating engineer to reposition it.
Temperature rises instead of falling.	Clock time incorrectly set.	Check time setting.
Room temperature too high during “Economy” and/or “Frost” mode.	The building retains a lot of heat.	Set an earlier switching time for “Economy” and/or “Frost”.
Incorrect or no control.	BUS connection or BUS subscriber faulty.	Ask your installer to check the BUS connection against the wiring diagram and correct it if required.
Controller can only be set to automatic mode.	Mode selector faulty.	Have FW 100 replaced by your installer.

Tab. 24

Fault	Cause	Remedy
Domestic hot water cylinder does not heat up.	Domestic hot water temperature control on boiler set too low.	Set domestic hot water temperature control higher. Reduce influence of solar optimisation if necessary.
	Flow temperature controller on the boiler set too low.	Turn the flow temperature control on the boiler clockwise as far as it will go.
	Domestic hot water programme fault.	Check/correct programme.
	Incorrect System configuration for domestic hot water system.	Correct the configuration to match the domestic hot water system connected.

Tab. 24

If the fault persists:

- ▶ Call the authorised installer or customer service and inform them of the fault, quoting the controller details (from the identification plate inside the flap).

Appliance details

Type:

.....

Order number:

.....

Date of manufacture (FD...):

.....

10 Tips on saving energy

- With weather-compensated control, the flow temperature is controlled in accordance with the set heating curve: The colder the outside temperature, the higher the flow temperature. Save energy: Set the heating curve as low as possible in accordance with the building's insulation and the system conditions (→ chapter 8.3 from page 56).
- Underfloor heating:
Do not set the flow temperature higher than the maximum flow temperature recommended by the manufacturer (e.g. 60 °C).
- Make effective use of the temperature levels and switching points by setting them to suit the preferences of the occupants.
 - **Comfort** ☼ = Comfortable living environment
 - **Economy** ☾ = Active living environment
 - **Frost** ❄ = Away from home or asleep.
- Set the thermostat valves in all rooms so that the required room temperatures can be achieved. Only increase the temperature levels if the temperature has not reached after some time (→ chapter 6.2.2 on page 38).
- Much energy can be saved by reducing the room temperature via economy phases. Reducing the room temperature by 1 K (°C) enables up to 5% energy to be saved. It is not recommended to let the room temperature of heated rooms fall below +15 °C during the daytime, otherwise the cooled-down walls continue to radiate cold and the room temperature rises higher, leading to higher energy consumption than if an even heat supply is applied.
- With well insulated buildings it can be the case that the room temperature remains above the temperature set for **Economy**. Nevertheless energy is being saved as the heating

system stays off. In this case, you can set the switching point for **Economy**.

- Don't keep windows slightly open for ventilation. This leads to a constant extraction of heat from the room without noticeably improving the ambient air in the room.
- Vent briefly but intensively (open window fully).
- When ventilating, turn off the thermostatic valve or set the mode selector to **Frost**.
- Make effective use of the temperature levels and switching points for the domestic hot water by setting them to suit the preferences of the occupants.

Solar optimisation

Activate the **Optimizing influence DHW** by setting a value between 1 K to 20 K → chapter 6.5 on page 47. If the influence of the **Optimizing influence DHW** is too great, reduce the setting a small amount at a time.

Activate the **CH circuit optimizing influence** by setting a value between 1 K to 5 K → chapter 6.5 on page 47. If the influence of the **CH circuit optimizing influence** is too great, reduce the setting a small amount at a time.

11 Environmental protection

Environmental protection is a fundamental corporate strategy of the Bosch Group.

The quality of our products, their economy and environmental safety are all of equal importance to us and all environmental protection legislation and regulations are strictly observed.

We use the best possible technology and materials for protecting the environment taking account of economic considerations.

Packaging

Where packaging is concerned, we participate in country-specific recycling processes that ensure optimum recycling.

All packaging materials are environmentally compatible and can be reused.

Old appliances

Used appliances contain materials that should be recycled.

The components are easy to separate and the plastics carry identification markings. This allows the sorting out of the various assemblies for appropriate recycling or disposal.

12 Commissioning log for the heating system

Customer/System operator:	System installer:
Date commissioned:	FD (Date of manufacture):
Solar heating system: Basic solar heating system: 1 <input type="checkbox"/> Solar options: E <input type="checkbox"/>	Domestic hot water systems: <input type="checkbox"/> : Combi boiler <input type="checkbox"/> : Cylinder on boiler
The following work has been carried out	
Water circulation systems checked <input type="checkbox"/> Remarks:	
Electrical connections checked <input type="checkbox"/> Remarks:	
Automatic configuration completed <input type="checkbox"/> Remarks:	
Heating circuit configured <input type="checkbox"/> Remarks:	
DHW systems configured <input type="checkbox"/> Remarks:	
Solar system configured <input type="checkbox"/> and commissioned <input type="checkbox"/> Remarks:	
Appliance function checked <input type="checkbox"/>	
Customer/system operator instructed how to operate the appliance <input type="checkbox"/>	
Appliance documentation handed over <input type="checkbox"/>	
Signature of system installer and date:	

Tab. 25













































































13 Individual timer programme settings

The default settings and personal settings for the timer programmes are summarised below.

13.1 Heating programme for heating system

























































How to set the heating programmes is described in Section 6.2 on page 36.

Ready-made heating programmes (for copying)

	P1		P2		P3		P4		P5		P6	
	  		  		  		  		  		  	
AM weekday worker												
Mo - Th		06:00		08:00		12:00		22:00 ¹⁾	-	-	-	-
Fr		06:00		08:00		12:00		23:30 ¹⁾	-	-	-	-
Sa		07:00		23:30 ¹⁾	-	-	-	-	-	-	-	-
Su		08:00		22:00 ¹⁾	-	-	-	-	-	-	-	-
PM weekday worker												
Mo - Th		07:00		12:00		17:00 ¹⁾		22:00 ¹⁾	-	-	-	-
Fr		07:00		12:00		17:00 ¹⁾		23:30 ¹⁾	-	-	-	-
Sa		07:00		23:30 ¹⁾	-	-	-	-	-	-	-	-
Su		08:00		22:00 ¹⁾	-	-	-	-	-	-	-	-
Full weekday worker												
Mo - Th		06:00		08:00		17:00 ¹⁾		22:00 ¹⁾	-	-	-	-
Fr		06:00		08:00		17:00 ¹⁾		23:30 ¹⁾	-	-	-	-
Sa		07:00		23:30 ¹⁾	-	-	-	-	-	-	-	-
Su		08:00		22:00 ¹⁾	-	-	-	-	-	-	-	-
AM+PM weekday worker												
Mo - Th		06:00		08:00		12:00		13:00 ¹⁾		17:00 ¹⁾		22:00 ¹⁾
Fr		06:00		08:00		12:00		13:00 ¹⁾		17:00 ¹⁾		23:30 ¹⁾
Sa		07:00		23:30 ¹⁾	-	-	-	-	-	-	-	-
Su		08:00		22:00 ¹⁾	-	-	-	-	-	-	-	-

Tab. 26

































































Individual timer programme settings

	P1		P2		P3		P4		P5		P6	
	  		  		  		  		  		  	
Home all day (Default setting)												
Mo - Th		06:00		22:00 ¹⁾	-	-	-	-	-	-	-	-
Fr		06:00		23:30 ¹⁾	-	-	-	-	-	-	-	-
Sa		07:00		23:30 ¹⁾	-	-	-	-	-	-	-	-
Su		08:00		22:00 ¹⁾	-	-	-	-	-	-	-	-
Home all day, early												
Mo - Th		04:00		22:00 ¹⁾	-	-	-	-	-	-	-	-
Fr		04:00		23:00 ¹⁾	-	-	-	-	-	-	-	-
Sa		07:00		23:00 ¹⁾	-	-	-	-	-	-	-	-
Su		07:00		22:00 ¹⁾	-	-	-	-	-	-	-	-
Home all day, late												
Mo - Th		06:00		23:30 ¹⁾	-	-	-	-	-	-	-	-
Fr		06:00		23:30 ¹⁾	-	-	-	-	-	-	-	-
Sa		07:00		23:30 ¹⁾	-	-	-	-	-	-	-	-
Su		08:00		23:30 ¹⁾	-	-	-	-	-	-	-	-
Senior citizens												
Mo - Th		07:00		23:00 ¹⁾	-	-	-	-	-	-	-	-
Fr		07:00		23:00 ¹⁾	-	-	-	-	-	-	-	-
Sa		07:00		23:00 ¹⁾	-	-	-	-	-	-	-	-
Su		07:00		23:00 ¹⁾	-	-	-	-	-	-	-	-

Tab. 26

1) Display subject to the selected "Display format"

Ready-made heating programmes in programme locations A to C (can be modified)

	P1		P2		P3		P4		P5		P6	
	  		  		  		  		  		  	
Programme A												
All days												
Mon - Fri												
Sat + Sun												
Monday		06:00		22:00 ¹⁾								
Tuesday		06:00		22:00 ¹⁾								
Wednesday		06:00		22:00 ¹⁾								
Thursday		06:00		22:00 ¹⁾								
Friday		06:00		23:30 ¹⁾								
Saturday		07:00		23:30 ¹⁾								
Sunday		08:00		22:00 ¹⁾								
Programme B												
All days												
Mon - Fri												
Sat + Sun												
Monday		06:00		08:00		17:00 ¹⁾		22:00 ¹⁾				
Tuesday		06:00		08:00		17:00 ¹⁾		22:00 ¹⁾				
Wednesday		06:00		08:00		17:00 ¹⁾		22:00 ¹⁾				
Thursday		06:00		08:00		17:00 ¹⁾		22:00 ¹⁾				
Friday		06:00		08:00		17:00 ¹⁾		23:30 ¹⁾				
Saturday		07:00		23:30 ¹⁾								
Sunday		08:00		22:00 ¹⁾								
Programme C												
All days		07:00		23:00 ¹⁾								
Mon - Fri												
Sat + Sun												
Monday												
Tuesday												
Wednesday												
Thursday												
Friday												
Saturday												
Sunday												

Tab. 27

1) Display subject to the selected "Display format"

Individual timer programme settings







Own settings

		P1	P2	P3	P4	P5	P6
	☀ ☾ ❄	☀ ☾ ❄	☀ ☾ ❄	☀ ☾ ❄	☀ ☾ ❄	☀ ☾ ❄	☀ ☾ ❄
	⌚	⌚	⌚	⌚	⌚	⌚	⌚
Programme location A, name: _____							
All days							
Mon - Fri							
Sat + Sun							
Monday							
Tuesday							
Wednesday							
Thursday							
Friday							
Saturday							
Sunday							
Programme location B, name: _____							
All days							
Mon - Fri							
Sat + Sun							
Monday							
Tuesday							
Wednesday							
Thursday							
Friday							
Saturday							
Sunday							
Programme location C, name: _____							
All days							
Mon - Fri							
Sat + Sun							
Monday							
Tuesday							
Wednesday							
Thursday							
Friday							
Saturday							
Sunday							

Tab. 28

13.2 DHW programme

How to set the domestic hot water programme is described in Section 6.3 on page 39.







	P1		P2		P3		P4		P5		P6	
	°C ¹⁾		°C ¹⁾		°C ¹⁾		°C ¹⁾		°C ¹⁾		°C ¹⁾	
Default setting												
Mo - Th	60/ On	05:00	15/ Off	23:00 ²⁾	-	-	-	-	-	-	-	-
Fr	60/ On	05:00	15/ Off	23:00 ²⁾	-	-	-	-	-	-	-	-
Sa	60/ On	06:00	15/ Off	23:00 ²⁾	-	-	-	-	-	-	-	-
Su	60/ On	07:00	15/ Off	23:00 ²⁾	-	-	-	-	-	-	-	-
Personal setting for Domestic hot water												
All days												
Mon - Fri												
Sat + Sun												
Monday												
Tuesday												
Wednesday												
Thursday												
Friday												
Saturday												
Sunday												

Tab. 29

- 1) Temperature level only on systems with DHW cylinder; On/Off with combination boilers
- 2) Display subject to the selected "Display format"

13.3 Domestic hot water circulation programme

How to set the domestic hot water circulation programme is described in Section 6.3 on page 39.

	P1		P2		P3		P4		P5		P6	
	On/ Off		On/ Off		On/ Off		On/ Off		On/ Off		On/ Off	
Default setting												
Mo - Th	On	06:00	Off	23:00 ¹⁾	-	-	-	-	-	-	-	-
Fr	On	06:00	Off	23:00 ¹⁾	-	-	-	-	-	-	-	-
Sa	On	07:00	Off	23:00 ¹⁾	-	-	-	-	-	-	-	-
Su	On	08:00	Off	23:00 ¹⁾	-	-	-	-	-	-	-	-
Personal setting												
All days												
Mon - Fri												
Sat + Sun												
Monday												
Tuesday												
Wednesday												
Thursday												
Friday												
Saturday												
Sunday												

Tab. 30

1) Display subject to the selected "Display format"

Index

- A**
- Accessories. **10**, 16
 - Appliance details
 - Accessories. 10
 - Automatic system configuration 18, **56**
- B**
- Basic display. 46
 - Being away from home. 26
 - Boiler
 - Equipment 9
 - Fault 66
 - Settings 36, 39, 56
 - BUS devices **56**, 66
 - BUS leads. 17
 - Button. 3
- C**
- Calibrate
 - Internal room temperature sensor 59
 - Calibrate internal room temperature sensor 59
 - Change heating program. . . 36, 37, 41, 42, 43
 - Change heating programme **36**
 - Changing operating mode 26
 - Changing room temperature **29**, 38
 - Climate zone 62
 - Coding of BUS devices 56
 - Colder
 - Heating 29, 36, 37, 41, 42, 43
 - Collector area 62
 - Commissioning (installers only) 18
 - Commissioning report 74
 - Contrast 46
 - Control quality. 13
 - Controller messages 66
 - Controls 3
 - Convectors. **56**, 57
 - Cooler
 - Domestic hot water 39
 - Customer service address 54, **64**
- D**
- Default settings. 25, 31, 49, 53, 60
 - Design temperature 58
 - DHW circulation pump
 - for thermal disinfection PE 11
 - Dimensions 13
 - Display
 - Basic display 46
 - Contrast 46
 - Display formats 46
 - Disposal 16, **73**
 - Domestic Domestic hot water circulation 43
 - Domestic hot water programme 33, **39**
- E**
- Electrical connections 16
 - Connecting bus devices 17
 - Environmental protection 73
- F**
- Factory settings. **25**, 31, 49, 53
 - Fault history 54
 - Fault indication 66
 - Fault rectification. 66
 - Faults. 54, 64, **66**
 - Boiler 66
 - Fitting
 - Accessories 16
 - Fitting location
 - Collector temperature sensor 68
 - Frost threshold temperature 58
- G**
- General settings 35, **46**

H

Heating 36

Heating circuit

- Mixed 44, 65
- Unmixed 44

Heating circuit without mixer 44

Heating curve 56, 57

Heating curve base point 56, 57, **58**

Heating curve end point 56, 57, **58**

Heating off at outside temperature 57, **58**

Heating off at too low temperature level 58

Heating programme. 32, **36**

Heating rate 38

Heating type in heating circuit **56**

Higher

- Heating **36, 38**

Holiday programme. **27, 31**

Hotter

- Domestic hot water. 39

I

Immediate DHW. 27

Individual timer programmes (table) 75

Info **49, 55, 64**

Information on the basic display 46

Information regarding these instructions 6

Installation 12

- Accessories. 16
- FW 100 in boiler. 12
- FW 100 to wall. 13
- Outside temperature sensor 15

Installation location

- Outside temperature sensor 15

Installer settings 52

- Configuring solar system. 53, **60**
- Customer service address 54, **64**
- Fault history 54
- Heating parameters. 53, **56**
- Screed drying 55, **65**
- Solar system parameters 54, **60**
- System configuration 53, **56**
- System faults **64**
- System info. 55, **64**

Intended use. 9

K

Key lock 46

L

Leaving the apartment 26

Leaving the house 26

Location

- FW 100. 13

Lower

- Heating. **36, 38**

M

Main menu

- Domestic hot water 33, **39**
- General settings 35, **46**
- Heating. 32, **36**
- Holiday **27, 31**
- Solar 35, **47**

Menu

- Info 49
- Installer settings 52
 - Configuring solar system 53, **60**
 - Customer service address. 54, **64**
 - Fault history 54
 - Floor dehumidification. 55
 - Heating parameters 53, **56**
 - Screed drying **65**
 - Solar system parameters 54, **60**
 - System configuration 53, **56**
 - System faults **64**
 - System info 55, **64**
- Main menu
 - Domestic hot water 33, **39**
 - General settings 35, **46**
 - Heating 32, **36**
 - Holiday **27, 31**
 - Solar 35, **47**

Menu structure 31, 49, 53

Mixed heating circuit 44, 65

Mixer operating time 59

N

Night-time operation (economy). 38

- O**
- Operation. 19
 - Changing domestic hot water mode 27
 - Changing room temperature. 29, **38**
 - Changing the operating mode for heating. 26
 - Setting heating temperature. 38
 - Option E: Thermal disinfection of the solar cylinder. 11, **60**
 - Outside temperature 72
 - Outside temperature sensor 15
- P**
- Packaging. 16, **73**
 - Product details
 - Standard package 9
 - Programming
 - Installer settings. 52
 - Resetting to default settings
 - All settings 25
 - Set fast heat-up 38
 - Set heating program **36, 37, 41, 42, 43**
 - Setting domestic hot water programme. 39
 - Setting heating programme **36**
 - Setting holiday programme 27
 - Setting language. 46
 - Setting summer/winter time. 46
 - Setting the date 46
 - Setting the time 46
 - Setting timer programme for hot water circulation pump 43
- R**
- Radiators **56, 57, 72**
 - Recycling 73
 - Reserve power supply
 - Mains power failure. 9
 - Reset
 - All settings 25
 - Room influence 58
 - Rotary selector 3
- S**
- Safety precautions 8
 - Segment 3
 - Set heating start. 36, 37, 41, 42, 43
 - Set increased/decreased heating level **36, 37, 41, 42, 43**
 - Set screed drying. 65
 - Setting constant economy 26
 - Setting constant Frost protection 26
 - Setting constant heating 26
 - Setting economy mode 26
 - Setting Frost protection mode 26
 - Setting heating higher/lower **36**
 - Setting heating mode 26
 - Setting heating start time. **36**
 - Setting heating temperature 38
 - Setting language 46
 - Setting summer/winter time 46
 - Setting the date 46
 - Setting the time 46
 - Setting up automatic mode. 26
 - Solar optimisation 47
 - Solar programme 35, **47**
 - Solar pump
 - SP 11, **61**
 - Standard package 9
 - Standard solar system. **61**
 - Symbols 3
 - System configuration
 - Automatic 18, **56**
 - System faults **64**
 - System information **49, 64**
- T**
- Technical data 10
 - Thermal disinfection 28, **44**
 - Thermostatic valves 72
 - Time adjustment 46
 - Timer programmes 20, **36, 75**
 - Times for hot water 39
 - Troubleshooting 66
- U**
- Underfloor heating. 56, **57, 65, 72**
 - Used appliances 73
- V**
- Venting. 72
- W**
- Wall installation. 13
 - Warmer
 - Heating 29, 36, 37, 41, 42, 43



067206177639

CONTACT INFORMATION

WORCESTER, BOSCH GROUP:

TECHNICAL: 08705 266241
SERVICE: 08457 256206
SPARES: 01905 752571
LITERATURE: 01905 752556
TRAINING: 01905 752526
SALES: 01905 752640
WEBSITE: www.worcester-bosch.co.uk

Dedicated to heating comfort

Worcester, Bosch Group
Cotswold Way, Warndon, Worcester WR4 9SW
Tel. 01905 754624 Fax. 01905 754619
Worcester, Bosch Group is a brand name of
Bosch Thermotechnology Ltd.
www.worcester-bosch.co.uk

