



Vokèra

DOMESTIC HEATING APPLIANCES

Mynute

28SE

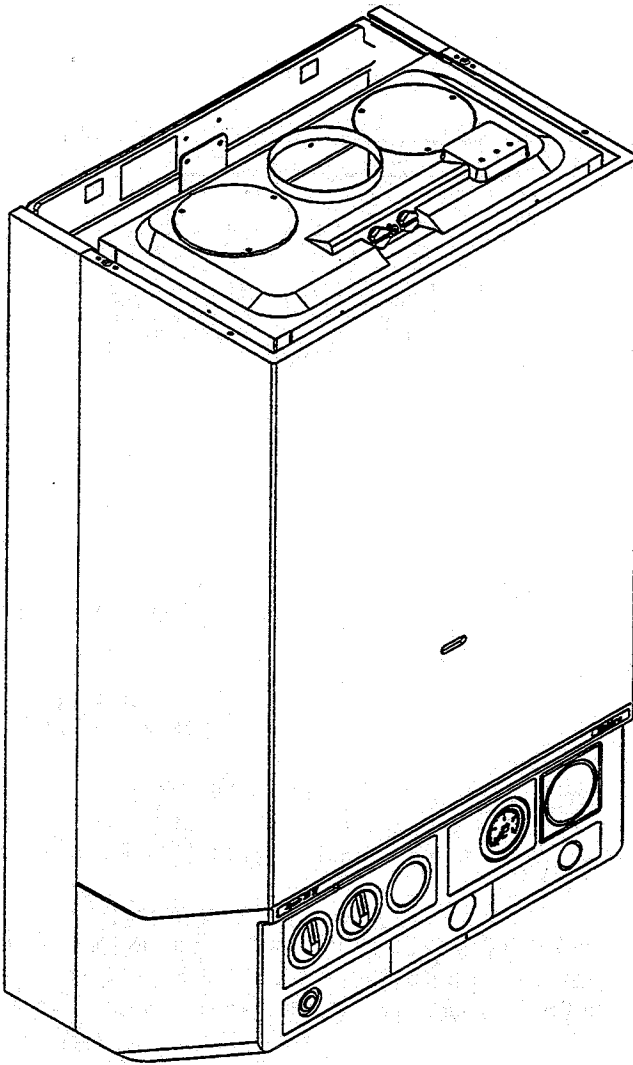

Users Instructions



Tested and Certified
63 AQ 0640

British Gas Service Listed
G.C. No. 41 094 14

**HAND THESE
INSTRUCTIONS
TO THE USER**

BEFORE ATTEMPTING TO LIGHT APPLIANCE PLEASE MAKE SURE THAT IT IS CHARGED UP WITH WATER WITH THE NEEDLE POINTING AT 1bar ON THE PRESSURE GAUGE (3)

Gas Safety (Installation and Use) Regulations 1996

In your own interests and that of safety, it is the law that all gas appliances are installed and serviced by a competent person in accordance with the above regulation.

GAS LEAK OR FAULT

IF A FAULT OR GAS LEAK IS SUSPECTED, TURN OFF THE APPLIANCE AND CONTACT YOUR INSTALLATION COMPANY OR LOCAL GAS REGION.

INTRODUCTION

Your Vokera Mynute is a central heating boiler, and with the addition of an indirect hot water cylinder it can supply stored hot water.

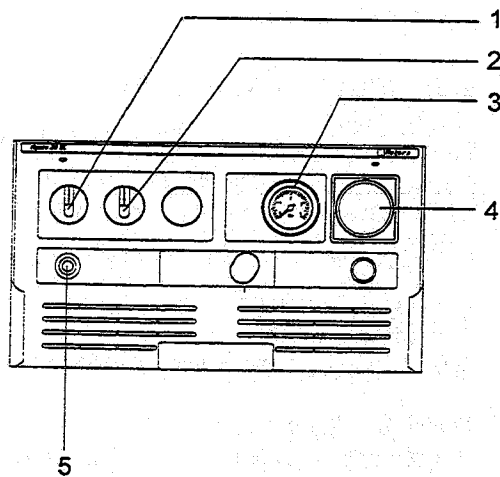

Boiler Location

Clearances

Minimum - above casing 225mm (9in)

Minimum - below casing 150mm (6in)

Minimum - In front 600mm (24in)

Minimum - At sides 25mm (1in) from casing

If the appliance is fitted in a compartment it should not be used as a storage cupboard (e.g. for food).

NEVER HANG CLOTHES ETC. OVER THE APPLIANCE.

1. Mode Selector Switch
2. Thermostat Control Knob
3. Pressure Gauge
4. Time Clock Aperture (Optional)
5. Lockout Reset Button

ELECTRICITY SUPPLY

WARNING: THIS APPLIANCE MUST BE EARTHED

Connection should be made to a 230v ~ 50Hz supply. The appliance must be protected by a 3amp fuse if a 13amp (BS 1363) plug or fused spur is used.

To connect a plug:



As the colour of the wires in the mains lead to this appliance may not correspond with the coloured markings identifying the terminals in your plug, proceed as follows:-

The wire which is coloured green-and-yellow must be connected to the terminal in the plug which is marked with the letter E or by the earth symbol \perp or coloured green or green-and-yellow.

The wire which is coloured blue must be connected to the terminal which is marked with the letter N or coloured black

The wire which is coloured brown must be connected to the terminal which is marked with the letter L or coloured red.

1.0 Lighting the boiler.

- 1.1 Switch on the electrical supply at the mains isolated point.
- 1.2 Ensure the gas supply to the appliance is turned on.
- 1.3 Turn the mode selector switch (1) to 
- 1.4 Should the appliance have either an internal time clock or external controls i.e. room thermostat, ensure that they are turned on and are calling for heat. The appliance will now go through an ignition sequence and the burner will light.
NOTE: Certain external timers and controls may over-ride the mode selector switch (1). In this case use the external timer or control to operate the appliance/system and leave the mode selector switch in the  position.
- 1.5 Should the appliance fail to ignite and the lockout reset button (5) illuminates, press the lockout reset button (5) once to restart the ignition process.
- 1.6 Adjust the Central heating temperature control (2) to suit the weather conditions.

N.B (i) For the quickest heat up of the premises the highest setting is needed at first, turning down later.

(ii) When Room Thermostats are used it may be best to leave the boiler thermostat at a high setting and set the room thermostat as required.

3.0 SAFETY LIMITS

3.1 Systems pressure

The water pressure gauge (3) must read between 1bar and 1.5 bar when the system is cold. Leaks or radiator venting will reduce this. Call in your service installer if excessive topping up of the system to restore pressure is necessary. A built-in safety valve operates if boiler pressure exceeds 3bar whether hot or cold. If the safety valve operates (water/steam discharges to drain) switch off and call your Installer or Service Engineer.

- 3.2 If the appliance water temperature rises too high, a high limit thermostat operates to extinguish the burner. This will automatically reset when the appliance has cooled sufficiently. If the cut out operates again, the appliance must be checked by a competent person, before relighting.

N.B. The central heating flow and return valves have an indicating line marked on the square shank, the line is horizontal when closed and vertical when open. Leave in the vertical (open) position.

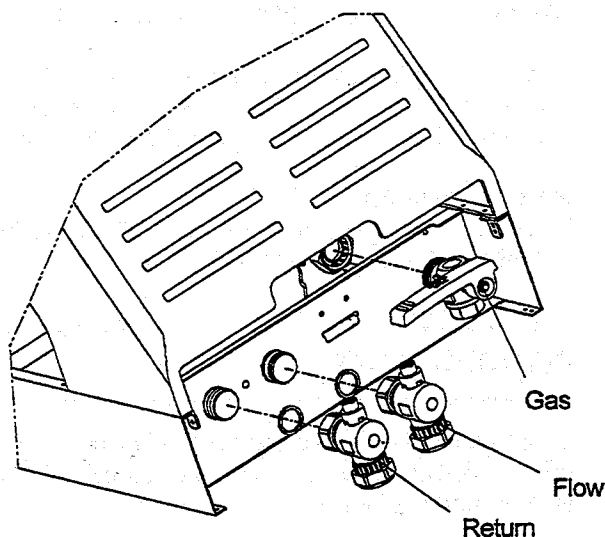

3.0 SHUTTING DOWN THE SYSTEM

For short periods:

Turn the mode selector switch (1) to 'O' (If external controls are over-riding the mode selector switch, switch these controls to the off position).

For longer periods also:

Turn off gas cock and
Turn off main electricity supply to boiler.

However, if the building is vacated when there is risk of freezing shut down the boiler as described and drain the system: Open all heating radiator valves and drain through the cocks usually provided at the lowest point of the system. To ensure draining of radiators open radiator air cocks remembering to close them when the operation is complete.

Alternatively, install a frost stat and leave the mains electricity and gas supply turned on.

N.B. Refilling a sealed system must be undertaken by a competent person following approved procedures.

4.0 RELIGHTING THE BOILER

Relight by following steps 1.0 to 1.6 given previously, after ensuring that refilling of the sealed system has been carried out.

5.0 CLEANING THE OUTER CASE

Use a clean damp cloth. Do not use abrasive cleaners.

6.0 SPARE PARTS AND SERVICING

Your Vokera Mynute must be serviced annually. Please contact your local Vokera Service Agent, your local Gas Region or a competent Installer.

VOKERA INTEGRAL TIME CLOCKS

MECHANICAL 24 HR VERSION (PART NO. 201)

Setting the time.

The time of day can be set by grasping the outer edge of the black dial and turning it in a clockwise direction until the correct time is in line with the white pointer.

Setting the 'switching times'

The 'ON' periods are set by sliding the green tappets, adjacent to the time periods required, to the outer edge of the dial.

The tappets that remain at the centre of the dial will be the 'OFF' periods.

N.B. The smallest switching time (ON or OFF) is 15 minutes.

To select 'Timed' mode move the selector switch in the middle of the clock face to the ⊕ position.

To select 'Constant' mode move the selector switch in the middle of the clock face to the 'I' position.

To select 'Off' mode move the selector switch in the middle of the clock face to the 'O' position.

DIGITAL 7 DAY VERSION (PART NO. 202)

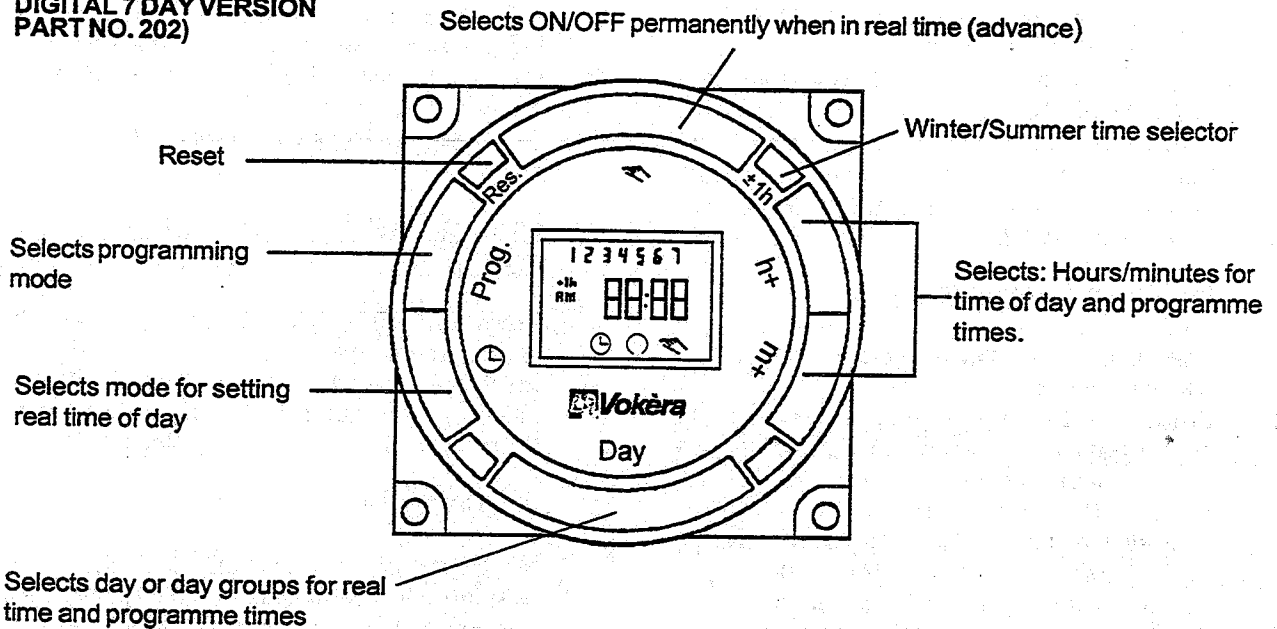

SETTING INSTRUCTIONS

The Vokera digital timeswitch has besides the normal group timing facility, capacity to programme individual daily settings. It has a total of 20 storage spaces for switching operations, each space can be programmed as either an ON or OFF instruction, and can be applied to any one day or four day combinations.



SCREEN INFORMATION

Days of week 1 2 3 4 5 6 7
 ON selection
 OFF selection
 Continuously ON
 Continuously OFF
 Winter/Summer time +1hr
 Timed mode
 Override selection
 Programme spaces ___ : ___
 Number of free spaces FR





BEFORE PROGRAMMING

Press the reset button using a pencil or similar instrument. This clears the memory of unwanted information in readiness for programming. The reset button should be used in the event of local interference causing the timeswitch to appear to malfunction. Local interference dependant on location may be present from time to time.

SET CURRENT TIME AND DAY

- 1 Press and hold the  button during operations 2 - 5 below.
- 2 Press the 'Day' button to select the current weekday (1 = Monday, 2 = Tuesday etc.)
- 3 If setting in British summertime press the +/- 1h button once.
- 4 Press the 'h+' button to select the correct hour.
- 5 Press the 'm+' button to select the correct minute.
- 6 Now release the  button - the colon between the hours and minutes will flash to indicate that the clock is running.









ENTERING SWITCHING TIMES

- 1 Press the 'prog.' button to select the first free memory location.
- 2 Press the 'Day' button to select the day or group of days required for switching to occur. You have a choice of day groups: 1 - 7 (Mon - Sun), 1 - 6 (Mon - Sat), 1 - 5 (Mon - Fri), 6 - 7 (Sat & Sun), or any individual day. Each programme space automatically starts with the day selection 1 - 7. You can change this with the day button.
- 3 Press the 'h+' button to select the hour the switching is to occur.
- 4 Press the 'm+' button to select the minute the switching is to occur.
- 5 Press the  button once to select an ON  instruction, or twice to select an OFF  instruction.
- 6 Press the 'Prog.' button to store your programmed information, and select the next free programme space. Or if you have finished loading the programme press the  button which will save the programme and return the timeswitch to the current time display.
- 7 Programme further switching instructions as above.
- 8 Pressing the 'Prog.' button one additional time after you have finished programming displays the remaining number of programme spaces that are free, e.g. 'Fr 12'. If all programme spaces are full, 'Fr 00' will appear.

Important Note: After programming is completed, and you return the timeswitch to the current time display with the  button, the timeswitch will not activate any switching instruction required for the current time. You may need to manually select the desired switching state with

the  button. Thereafter, as the unit encounters further switching instructions in the memory in real time, it will correctly activate all subsequent switching instructions.

MANUAL OVERRIDE

With the  button you can manually operate the switch to switch ON or OFF outside the programmed times, or you can put the switch into a permanent ON or OFF condition. The first press of the  button advances the output to ON or OFF ( or  together with the  symbol displayed to show that the programme has been overridden) without disrupting the programme sequence. The second press fixes the output in the continuously ON  condition. The third press fixes the output in the continuously OFF  condition. In either fixed condition, the timeswitch will only revert to the timed condition if you press the  button once more.

READ OR CHANGE PROGRAMMED INFORMATION

Press the 'Prog.' button repeatedly to view each of your programmed instructions in the order in which they were programmed. You can stop to alter any of the instructions using the buttons as described in 'Entering switching times' above. *

RUNNING RESERVE

In the case of mains electrical failure, the internal battery will ensure that the actual time of day continues to operate and that the automatic switching programme remains intact. The clock can be programmed completely even without mains supply, provided the battery back up is fully charged. (Charging time 70 hours approx.)

SUMMER/WINTER CHANGEOVER

From summer time to winter time: Depress the +/-1h key once (symbol +/-1h disappears from display)

From winter to summer time: Depress the +/-1h once. Display shows +/-1h symbol)

Alternatively you can follow the instructions described in 'Set current time and day' above.

SETTING INSTRUCTIONS FOR THE VOKERA 7 DAY 2 CHANNEL PROGRAMMER

The Vokera 2 channel 7 day programmer will automatically switch your central heating system ON and OFF once, twice or three times a day, whichever you wish and at whatever times you choose each day of the week.

It incorporates a rechargeable battery back-up system to protect the programme during power cuts of up to 24 hours, even though display will go blank.

The clock in the programmer has to be set to the actual day of the week and time of day.

It must then be told at what times you want it to switch your Central Heating (CH) and Hot Water (HW) system ON and OFF for each day of the week. This set of switching times is known as a programme.

The programmer has an in-built programme of standard switching times. They may well be right for you, but if they are not exactly what you want you can change them.

The standard programme is shown in the table on the following page, and, for simplicity, the switching operations are described as ON1, OFF1, ON2, OFF2, ON3, OFF3 from now on.

SETTING THE CLOCK

Use the chart to plan your own programme before proceeding.

Switch on the mains supply to the boiler, then switch the mode selector switch (1) ON. Press and release the button marked SET.

The display will show

SET
CLOCK ?

Press and release the button marked YES to answer the question and the day part of the display will flash. Use + and - buttons to change to the correct day then press SET again.

This will cause the hour part of the display to flash. Use the + and - buttons to change to the correct hour (check AM or PM) then press SET again. This will cause the minutes part of the display to flash. Again use the + and - buttons to change the minutes as required, then press SET again.

The display will now show

SET
PROG ?

(see later instructions for changing your programme).

Press the SET again

The display will now show

TEST ?

(again see later instructions)

Press the SET button again.

The display will show

SET
H'DAY ?

(again see later instructions about this holiday setting feature). Press SET once again and the display will show actual time of day and day of the week you have set.

PROGRAMME TEST

As described earlier, there is a place in the programming sequence where you will be given the opportunity to press YES when the display shows TEST ? This feature is available so you can quickly run through the ON and OFF times set to make sure they are what you want.

Answer YES and the display will show a time just past midnight on the morning of the day of the week you are actually in. Now press and hold down the YES button again. The time display will start to "run" and will pause for 2-3 seconds when it reaches the ON1 time for that day, the ON indicator light will be energised as will the circuit being controlled. If you release the YES button the display will stop running and give you more than 2-3 seconds to think about a switching time.

Continue pressing YES and the display will now "run" to the OFF1 time when it will pause again and the time switch will switch off. It will then "run" to the ON and OFF times in turn, pausing at each before moving to the next day and identifying the ON and OFF times in the same way.

The programmer will continue identifying the ON and OFF times in this way for each day in sequence until you press the SET button when it changes to the holiday setting mode. Pressing SET button again returns the module to normal operating mode.

HOLIDAY SETTING

Note: This useful feature allows you to set the number of days you want your system to be permanently off before automatically switching on at the programmed time.

The programmer counts each pass through mid-night as one day, so if on Saturday morning you don't want the system on again until Tuesday morning you set the counter to 3. If when the display shows SET H'DAY ? you press the YES button the display will show OO. By using the + and - buttons you can now set the number of days you want the system to be off, a maximum of 99 days is possible.

Now press SET again and the display will be blank apart from H'DAY. Having counted down to zero, the programmer will switch the system on at the times set for that day. If you wish to cancel the H'DAY setting, press any button and normal operation will be resumed. Your module is now in the operating mode and ready to work using the built-in standard programme times.

PROGRAMME OPTIONS

Hot water and central heating can be operated independantly.

The programmer gives you 4 options for both CH and HW:

- OFF - Off all the time
- TIMED - On/Off at all periods set in programme
- ONCE - On for one period each day (ON1 >> OFF3)
- ON - On all the time

Obtain the options you require by using the **SELECT** buttons to move the arrows in the display to the appropriate positions. Your module is now working using the standard programme times. If these suit your needs there is nothing else to do.

You can temporarily override the normal switching times by pushing a button marked **ADVANCE**. This switches **ON** to **OFF** to **ON** as you require, but the normal programme switching times will not be permanently affected. If you want to make changes to the programme, it is suggested you write them down before making the changes.

CHANGING YOUR PROGRAMME

With the module in the operating mode and the display showing the actual time of day, press the **SET** button. The display will again show **SET CLOCK ?** but this has already been done so push the **SET** button again. The display will again show **SET PROG ?** and as it is the programme settings which are to be changed press the **YES** button.

The display will show



NOTE: The grouping of days in this way is to enable timings which apply to each and all of the weekdays to be set first, followed by the opportunity to change one or more timings for any single day.

If you wish to set timings which will be the same for each weekday press the **YES** button.

The display will show



press **YES** and make the changes or press **SET** if no changes are required.

The display will now show



press **YES** to make changes or **SET** if no changes are required.

The display will now show



press **YES** if you wish to make changes to Monday timings or press **SET** to change the display to **SET TUE PROG ?** Again press **YES** to make changes to Tuesday timings or continue to operate the **SET** button to access each weekday in turn.

If you press **YES** to make changes to the settings for a particular day, the display will firstly show **SET CH**

Press **YES** will allow changes to be made to the central heating settings, but pressing **SET** will cause the display to show **SET HW** Press **YES** will allow the changes to be made to the hot water settings, a further press of **SET** will move the display on the next day.

After any Friday changes have been made press **SET**.

The display will show



This gives you the chance to set timings which will apply to both weekend days by answering **YES**. Further operation of the **SET** button accesses **SAT** and **SUN** for individual timing changes.

Pressing **SET** after finishing any weekend programme changes, or pressing **SET** in answer to **SET PROG ?** returns the module to **TEST ?** Pressing **SET** again display **SET HOL ?** Pressing **SET** again returns the module to the normal operating mode.

SWITCHING	MONDAY - FRIDAY		SATURDAY - SUNDAY	
	H/W	C/H	H/W	C/H
ON1-Start of first timed period of day (ON)	6.30am	6.30am	6.30am	6.30am
OFF1-End of first timed period (OFF)	8.30am	8.30am	9.00am	9.00am
ON2-Start of second timed period (ON)	12 noon	12 noon	12 noon	12 noon
OFF2-End of second period (OFF)	12 noon	12 noon	12 noon	12 noon
ON3-Start of third period (ON)	4.30pm	4.30pm	4.00pm	4.00pm
OFF3-Final switch 'OFF'	10.30pm	10.30pm	11.00pm	11.00pm

If you answer **YES** to any of the detailed programming questions the following steps will apply.

The display will show the time set for the first switch on (**ON1**) to occur for the day(s) concerned. This can be altered in steps of 10 minutes by use of the + and - buttons. When the display is showing the time you want, press **SET** and the **OFF1** time will be seen.

Again changes may be made with the + and - buttons before pressing **SET** to show the time for **ON2** to occur. After making any adjustments press **SET** again to get the **OFF2** time displayed. Repeat this operation for the **ON3** and **OFF3** settings. This may be set up to 23 hours 50 minutes after the first switch on time.

Further operations of the **SET** button will take you through any remaining days of the week to be programmed before arriving at the operating mode and ready to work at the times you have set.

HELPFUL HINTS

1. The + and - buttons are used to change times. Press and release for small changes; press and hold down and the time will 'run'.
2. You cannot set the first switch on time (**ON1**) before mid-night but you can set the **OFF3** after midnight so long as you don't try to exceed 23 hour 50 mins after **ON1**.
3. The switching times have to be in sequence (**ON1, OFF1, ON2, OFF2, ON3** and **OFF3**) if you try to set **OFF1** earlier than **ON1** the display will stop at the **ON1** time with the **OFF** symbol flashing. The same thing will happen with other switching times e.g. between **OFF1** and **ON2**, this time the **ON** symbol will flash.
4. If you attempt to set the **ON1** after the **OFF1** time, the **ON** symbol will flash and the **OFF1** setting will follow the **ON1** time being set to prevent incorrect programming. The same feature applies with the other **ON** and **OFF** times and also between the **OFF** and **ON** times.
5. To use only two switching per day set the **ON2** & **OFF2** times both to 12.00
6. If you get confused and wish to start the whole programming procedure again, press the **SET** and + buttons together for a moment. The module will revert to a mid-night time display and the built-in standard programme. You will now have to set the clock again and then enter the programme you want.

7. When you are making adjustments to timings, if no button is pressed for 1 to 2 minutes, the module will automatically revert to the normal operating mode.
8. To shut the **CH** down for the Summer simply select the **OFF** option by means of the **CH SELECT** button.

SETTING INSTRUCTIONS FOR THE VOKERA 24HR 2 CHANNEL PROGRAMMER

The Vokera 2 channel 24hr programmer will automatically switch your central heating system ON and OFF once or twice a day, whichever you wish and at whatever times you choose. You also have the option to obtain continuous ON or OFF operation.

It incorporates a rechargeable battery back-up system to protect the programme during power cuts of up to 24 hours, even though display will go blank.

The clock in the programmer has to be set to the actual time of day.

It must then be told at what times you want it to switch your Central Heating (CH) and Hot Water (HW) system ON and OFF. This set of switching times is known as a programme.

The programmer has an in-built programme of standard switching times. They may well be right for you, but if they are not exactly what you want you can change them.

The standard programme is shown in the table overleaf, and, for simplicity, the switching operations are described as ON1, OFF1, ON2, OFF2 from now on.

SETTING THE CLOCK

Use the chart overleaf to plan your own programme before proceeding.

Switch on the mains supply to the boiler, then switch the mode selector switch ON. Press and release the button marked SET.

The display will show

SET
CLOCK ?

Press and release the button marked YES to answer the question and the hour part of the display will flash. Use the + and - buttons to change to the correct hour (check AM or PM) then press SET again. This will cause the minutes part of the display to flash. Use the + and - buttons to change the minutes as required, then press SET again.

The display will now show

SET
PROG ?

(see later instructions for changing your programme). Press the SET button again and the display will now show the time of day you have set.

Your programmer is now in the operating mode and ready to work using the built-in standard programme times.

CHANGING YOUR PROGRAMME

With the module in the operating mode and the display showing the actual time of day, press the SET button. The display will again show SET CLOCK ? but this has already been done so push the SET button again. The display will now show SET PROG ? and as it is the programme settings which are to be changed press the YES button.

The display will show

SET CH
PROG ?

NOTE: If you wish to make changes to the ON or OFF timings for CH you press the yes button, if not you press the SET button again and this will change the display question to SET HW PROG ?.

Again you have to answer the question either with the YES button or by pressing the SET button which returns the programmer to the normal operating mode with the time of day displayed.

If you answer YES to SET CH PROG ? the display will show the time set for the first CH ON (ON1). This can be altered in steps of 10 minutes by the use of the + & - buttons. When the display is showing the time you want, press SET and the CH OFF (OFF1) time will be seen.

Again changes can be made using the + & - buttons before pressing SET to display the time for CH ON (ON2). After making any adjustments press SET again to get the CH OFF (OFF2) time displayed. This may be adjusted up to 23hrs & 50 mins. after the first switch on time.

Press the SET button again and the question SET HW PROG ? will be displayed.

SET HW
PROG ?

By answering YES, the same procedure can be followed for adjusting the HW timings before pressing SET one final time to go back to the time of day.

HELPFUL HINTS

1. The + and - buttons are used to change times. Press and release for small changes; press and hold down and the time will 'run'.
2. You cannot set the first switch on time (ON1) before mid-night but you can set the (OFF2) after midnight so long as you don't try to exceed 23 hour 50 mins after (ON1).
3. The four switching times have to be in sequence (ON1, OFF1, ON2, OFF2) if you try to set OFF1 earlier than ON1 the display will stop at the ON1 time with the OFF symbol flashing. The same thing will happen with other switching times e.g. between OFF1 and ON2, this time the ON symbol will flash.
4. If you attempt to set the ON1 after the OFF1 time, the ON symbol will flash and the OFF1 setting will follow the ON1 time being set to prevent incorrect programming. The same feature applies with the other ON and OFF times and also between the OFF and ON times.
5. If you get confused and wish to start the whole programming procedure again, press the SET and + buttons together for a moment. The module will revert to a mid-night time display and the built-in standard programme. You will now have to set the clock again and then enter the programme you want.
6. When you are making adjustments to timings, if no button is pressed for 1 to 2 minutes, the module will automatically revert to the normal operating mode.
7. To shut the CH down for the Summer simply select the OFF option by means of the CH SELECT button.

PROGRAMMER OPTIONS

Hot water and central heating can be operated independently.

The programmer gives you 4 options for both CH & HW:

OFF - Off all the time.

TIMED - On/Off at all periods set in programme.

ONCE - On for one period each day (ON1 > OFF2).

ON - On all the time.

Obtain the options you require by using the **SELECT** buttons for CH & HW to move the arrows in the display to the appropriate position.

Press the **SET** button again and the question **SET HW PROG ?** will be displayed.

SWITCHING	STANDARD PROG.	
	H/W	CH
ON 1 - Start of first timed period of day (ON)	6.30am	6.30am
OFF 1 - End of first timed period (OFF)	8.30am	8.30am
ON 2 - Start of second timed period (ON)	4.30pm	4.30pm
OFF 2 - Final switch (OFF)	10.30pm	10.30pm

STANDARD PROGRAM FOR 24HR 2 CHANNEL PROGRAMMER



Vokèra Ltd

Southern Region: Clarisham House, Morson Road, Enfield, Middlesex EN3 4NQ Tel. 0181-804 7202, Customer Services Tel. 0181-804 4344 Fax. 0181-804 8163

Northern Region: Stubs Beck Lane, West 26 Business Park, Whitehall Road, Cleckheaton, West Yorkshire BD19 4TT Tel. 01274 865556 Fax. 01274 865557

Scottish Region: Shuna Street, Maryhill, Glasgow G20 9NW Tel. 0141-945 4944 Fax. 0141-945 5136