

---

## The Arden Multifuel Stove



PLEASE RETAIN THESE INSTRUCTIONS FOR FUTURE REFERENCE

---

Valor Heating  
Erdington  
Birmingham  
B24 9QP

Tel. 0121 373 8111  
Fax. 0121 373 8181  
[www.firesandstoves.com](http://www.firesandstoves.com)

Rev 3  
Part No: AFS1080

---

**WARNING**

TO ALL MULTIFUEL USERS

**PETROLEUM COKE**

SOME OF WHOSE BRAND NAMES ARE

**"CALCO", "PETROCOKE" OR "WONDERCO"**

MUST NOT BE BURNED IN THIS APPLIANCE

TO USE THESE FUELS WILL INVALIDATE THE  
APPLIANCE GUARANTEE

**IF IN DOUBT CONTACT THE SOLID FUEL ASSOCIATION  
TELEPHONE NUMBER 0800 600 000**

[www.solidfuel.co.uk](http://www.solidfuel.co.uk)

**OPERATING & INSTALLATION INSTRUCTIONS  
CONTENTS**

	<b>Page</b>	<b>OPERATING INSTRUCTIONS</b>	
<b>INTRODUCTION</b>			
Safety Notices	4	Air Inlet Controls	13
The Principle of the Fire	4	Multi-Purpose Operating Tool	13
Check List	5	Fire Door Glass	14
Technical Data	6	Door Adjustment	14
		Fuels	15
<b>INSTALLATION</b>		Lighting The Fire	16
General Precautions	7	Over-Firing	17
Handling	7	Annual Maintenance	18
Firebox Liner Panels	8		
Throat Plate Inspection	8	<b>GUARANTEE</b>	19
Flues & Chimneys	9 - 12	<b>FINAL FACTORY CHECK LIST</b>	20

---

## SAFETY

A fireguard conforming to BS 8423: 2002 should be used in the presence of children and old/or infirm people. If the appliance is used with the fire door open, a spark guard conforming to BS 3248 should be fitted.

**Do not use aerosol sprays or any other flame near the appliance under fire.**

**Do not fit an extractor fan in the same room as the appliance.**

**Fire cement is caustic, hand and eye protection should always be worn, prolonged contact with the skin should be avoided.**

**Valor will not be responsible for any consequential or incidental loss or injury however caused.**

Before continuing any further with the installation of this appliance please read the following guide to manual handling.

- Always obtain assistance when lifting the appliance.
- When lifting always keep your back straight. Bend your legs not your back.
- Avoid twisting at the waist. It is better to reposition your feet.
- Avoid upper body/top heavy bending. Do not lean forwards or sideways when handling the fire.
- Always grip with the palms of your hands. Do not use fingertips for support.
- Always keep the stove as close to the body as possible. This will minimise the cantilever action.
- Use gloves to provide additional grip.

---

## THE PRINCIPLE OF THE FIRE

Your **Arden Multifuel Stove** is built to the highest standard of craftsmanship using the best materials and the most modern equipment available. It is a highly efficient and sophisticated piece of machinery and when properly installed and operated it should provide a lifetime of heating satisfaction.

Safety is the most important consideration when installing your fire. If not properly installed and operated a house fire may result. Installation must comply with the Building Regulations and conform to all relevant fire safety standards.

**Valor** produce a variety of appliances ranging from the traditional to the modern in style and appearance, all bristling with "High Tech" features.

The fire doors are fitted with special high temperature ceramic glass panels through which the fire can be viewed.

The stove is lined with firebricks or heat reflective panels which ensure complete combustion and provide a good heat store to even out fluctuations in burning.









An internal throat plate produces turbulence to encourage secondary combustion and directs the flue gas around the whole upper firebox before allowing it to escape up the chimney.

**Valor** multifuel stoves are also fitted with an "air wash" so called because it provides a curtain of high speed preheated air behind the glass to help keep it clean and to provide secondary air/over draught.

The provision of two inlets on all multifuel stoves gives a wide range of primary air/secondary air, under draught/over draught combinations. The optimum settings will only be established by experience in firing the appliance, and will depend on type of fuel, the position of the appliance in the house, condition of chimney etc.

## CHECK LIST

Inside the appliance you should find the following:

Part Description & Visual Aid (not to scale)	Quantity	Part No.
1. Fuel grate 	1	AFS1078
2. Feet & fixings 	4	AFS1079
3. Throat plate 	1	AFS1074
4. Flue spigot 	1(4")	AFS009A
5. Hot plate 	1(4")	AFGS064
6. Ash pan 	1	AFS058
7. Operating tool 	1	AFS008
8. Rear liners 	1	AFS1069
9. Side liners 	2	AFS1068
10. Instructions	1	AFS1080

**The model and Serial Number of your fire can be found stamped into the casing, centrally just below the bottom edge of the fire door aperture.**

## TECHNICAL DATA

---

TECHNICAL DATA	Arden Multifuel
Room Min/Max Room heater only output (kW)	1-5
Height (mm)	540
Width (mm)	405
Depth (mm)	362
Height to centre of rear flue	440
Depth from back to centre of flue	105
Flue diameter	102 (4")
Weight Packed Kg	47

## GENERAL PRECAUTIONS

*Note - All installations must conform to the appropriate building regulations.*

The Building Regulations for England and Wales 2000 ref Approved Document J 2002 edition (issued by the DTLR).

The Building Standards (Scotland) (Consolidation) Regulations.

Detailed recommendations for installation of appliances, chimneys and flues are outlined in the current issue of the following British Standards:- BS6461, BS8303 and BS4543.

*Any Manufacturer's Instructions must not be taken as overriding statutory requirements.*

During installation ensure that adequate precautions are taken to avoid unnecessary risk to yourself or any householder. In particular the danger from the caustic nature of the fire cement should be avoided by using these accepted methods:

- Wear gloves when handling fire cement.
- Wear goggles when chiselling or looking up chimneys.

Make sure that Building Regulations are adhered to during installation along with any local by-laws. In the case of heating systems make sure that the pipe work is correctly bonded to ensure electrical earthing.

## HANDLING

By the time you read this you will appreciate the weight of the appliance. The Safety and handling guidelines as set out on page 4 of this manual should be followed.

To make movement easier internal fittings, fuel retainers, grates, firebox liners, flue outlets, hot plate, throat plate, etc., can be removed.

Care should be taken to make sure that the hinges are not damaged during installation.

## HEARTH

The fire should be installed to stand on a constructional hearth of non-combustible materials not less than 125mm (5") thick conforming to Building Regulations. Dimensions of the hearth should project at least 300mm (12") forward of the front of the appliance and 150mm (6") at the sides. The surface of the hearth should be free of combustible materials. In most buildings with solid concrete floors the requirement will be met by the floor itself, but mark the perimeter of the hearth to ensure floor coverings are kept well away or use different levels to mark the hearth perimeter.

## COMBUSTIBLE MATERIALS

A gap of at least 450mm (18") should be allowed between the appliance and any combustible materials including furnishings. Adjacent walls should be of suitable non-combustible construction, preferably brickwork. In large fireplaces take care that any supporting beam is protected by a 13mm (0.5") sheet of Masterboard/Supalux spaced 13mm (0.5") off the surface with strips of non-combustible material - not wood.

Make sure that there is a gap between an uninsulated flue system and any combustible material. This gap must be at least 3 x the outside diameter of the flue pipe, or 1.5 x the flue diameter to non combustible surfaces. see illustration p12.

## AIR FOR COMBUSTION

There must always be a permanent means of providing air for combustion into the room in which the fire is installed. A permanent vent with a total free area of at least 550mm<sup>2</sup> for every kW rated output above 5kw should be connected directly to the outside air or to an adjacent room which itself has a permanent vent of the same size direct to the outside air. The fitting of an extractor fan to either of these rooms is not recommended.

# INSTALLATION

---

## FIREBOX LINER PANELS

The Arden Multifuel stove use firebox liner panels to the sides and back. The throat plate sits on top of the side and rear panels. These should come fitted to your fire, if however they are not proceed as follows to fit them.

- Remove the front fuel bars or multifuel grate.
- Set the small liner into the back of the fire.
- Insert side liner panels into each side of the fire.
- Fit the throat plate with the single bend and two cut outs to the front facing up. The projecting lugs sit on top of the side liners. The long centre tab on the back edge rests on the rear liners. The shorter turn-down tabs against the vertical face.
- Replace the front fuel retainer bars or multifuel grate.

*Note: Neither the rear firebox liners nor the side firebox liners are "handed", both faces are suitable for direct contact with the fire.*

*Note: Cracking of lining panels does not effect efficiency.*

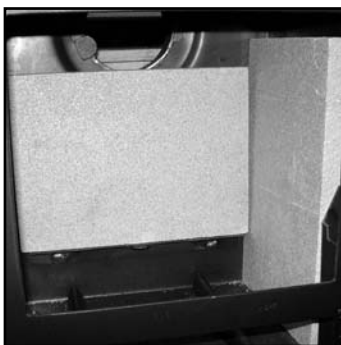

**Fig. 1** *Liners inserted into the Arden.*



**Fig. 2** *(Inserting Throat Plate)*



**Fig. 3** *Liners, throat plate and grate in the Arden.*

## REMOVAL OF THE THROAT PLATE

Blocked chimneys cause dangerous fumes to escape. Remove throat plate at least monthly to clean. Keep chimney and flue ways clear.



## FITTING THE FEET

The Valor Arden can be fitted with or without feet.

Care should be taken whilst assembling the feet so as not to damage the painted surface of the fire.

- The feet are positioned in each corner of the fire and fixed using the washers and screws provided.
- You will need a no. 2 pozidrive screwdriver to tighten the screws.***

## FITTING THE FLUE OUTLET AND HOT PLATE

The flue outlet spigot is found inside the appliance. The hot plate (blanking plate) is supplied fitted to the top opening and is removed by turning clockwise (as is the flue outlet).

Smear a very thin layer of fire cement on the faces of the flue outlet and the blanking plate. Fit the outlet to the appliance in the desired position.

Lock into place by rotating anti-clockwise and tighten by tapping with a block of wood and mallet from the inside of the appliance. Similarly, fit the blanking plate to the unused opening. Clean off any surplus fire cement.

Place appliance on the hearth and make sure that it is level and does not rock.

Connect the chimney ensuring all joints are sealed with fire cement.

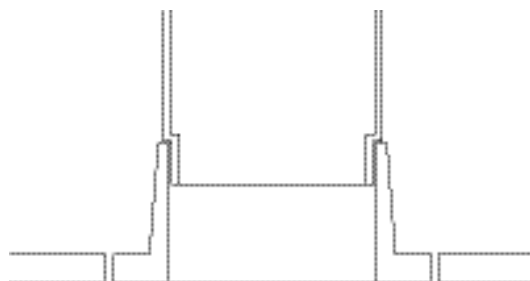

\*NOTE  
THE FLUE PIPE MUST BE FITTED INSIDE THE OUTLET SPIGOT  
FAILURE TO DO SO COULD RESULT IN THE SPILLAGE OF  
CONDENSATION ECT. RUNNING DOWN THE FLUE.

**Fig. 12 Flue and Spigot Fitting**

## FLUES AND CHIMNEYS

Please remember that chimney draught is dependent on four main factors:

- Flue gas temperature.
- Flue height.
- Flue size.
- Flue terminal.

The stove must be connected to a suitable and efficient flue that provides a good updraught to safely take the products of combustion (fumes) from the stove outlet to the outside air. To ensure a good updraught it is important that the flue gases are kept warm and that the flue size suits the stove.

The termination of the outlet at the top of the flue also needs to comply with the Building Regulations. The minimum effective height of the flue must be at least 4.5 metres from the top of the stove to the top of the flue outlet. When warm the flue draught should be between 0.1 and 0.2 mb.

A chimney may comply with the regulations but still be subject to down draught and similar problems. A chimney terminating above the ridge level is generally less likely to suffer such problems.

If a new chimney is being provided it should fully comply with the relevant Building Regulations that specify the requirements for solid fuel burning installations. Suitable types of chimney include the following.

**Masonry chimney** built with clay or concrete liners, or a chimney block system meeting Building Regulations. These types of chimney should be installed in accordance with the Building Regulations and BS 6461: Part 1.

**Factory made insulated chimney** complying with BS 4543: Part 2 (often called "Class 1 prefabricated metal chimney"). These types of chimney should be installed in accordance with the Building Regulations and BS 7566: Parts 1 to 4.

## INSTALLATION

---

Due to the gradual introduction of European Chimney Standards chimneys will be specified according to their performance designation as defined in BS EN 1443 that covers the General Requirements for chimneys. The minimum performance designation required for use with solid fuel burning stoves is T450 N2 S D3.

The flue and chimney installation must be carefully checked by a competent person before fitting the stove to ensure it is suitable and will work safely.

If the chimney is old (ie built of brick or stone without a liner) or being opened up for reuse additional checks and smoke testing as described in Appendix E of the Approved Document J 2002 Edition should also be carried out to ensure the flue and chimney are in good operating condition.

Unless the existing flue is in good condition with suitable access for collection and removal of debris. If the flue size is more than 225mm (9 inches) diameter or 200 x 200mm square, a suitable lining of 150mm (6 inches) diameter should be fitted, or if the flue length is over 5.5 metres one size larger than the appliance outlet should be fitted. This should be a double skin stainless steel flexible flue liner that is independently certified for use with solid fuel. Details of suitable linings for use with solid fuel are given in the Official HETAS guide that can be viewed on their website at [www.hetas.co.uk](http://www.hetas.co.uk)

It is also important that suitable flue pipe complying with the Building Regulations is used to connect the stove to the flue in the chimney and that suitable access is provided into the flue for regular inspection and sweeping of the flueways.

The installer should comply with the Building Regulation requirements in respect of providing a Notice Plate giving details on the chimney, flue lining, hearth and fireplace installation. Approved Document J of the Building Regulations for England and Wales is available from The Stationery Bookshops and can also be viewed at the ODPM website at [www.safety.odpm.gov.uk/bregs/brads.htm](http://www.safety.odpm.gov.uk/bregs/brads.htm)

Details on the relevant Building Regulations and BS British Standards are given in the "General

Precautions" section of these instructions.

A chimney may comply with the regulations but still be subject to down draught and similar problems. A chimney terminating above the ridge level is generally less likely to suffer such problems.

Chimneys should be as straight as possible. Horizontal runs should be avoided except where the rear outlet of the appliance is used, in which case the horizontal section should not exceed 150mm (6") in length.

If the fire appears to be working hard but produces very little output to the room it is likely that excessive draw is present in the chimney, and that heat is being sucked out of the appliance and up the chimney. If this is the case we recommend the fitting of a draught stabiliser in preference to a flue damper, in the interest of safety and efficiency.

We do not recommend the use of a damper when burning solid fuel.

### FOR ALL APPLIANCES

Access for cleaning the flue should be incorporated in the system other than through the appliance (e.g. a soot door or access through register plate). Purpose-made soot doors and inspection lengths are available from manufacturers of all systems.

Ensure that the whole length of the flue can be reached from the soot door.

*Note: if the appliance is fitted with a draught stabiliser or if one is fitted to the flue pipe or chimney in the same room as the appliance, then the permanent air entry opening (or openings) should be increased by 300mm<sup>2</sup> for each kW of rated output.*

**For advice on flues and chimneys contact;**  
**NACE (National Association of Chimney Engineer): telephone 0800 0924019**  
**[www.nace.org.uk](http://www.nace.org.uk)**  
**or**  
**NACS (National Association of Chimney Sweeps): telephone 01785 811732**  
**[www.chimneyworks.co.uk](http://www.chimneyworks.co.uk)**

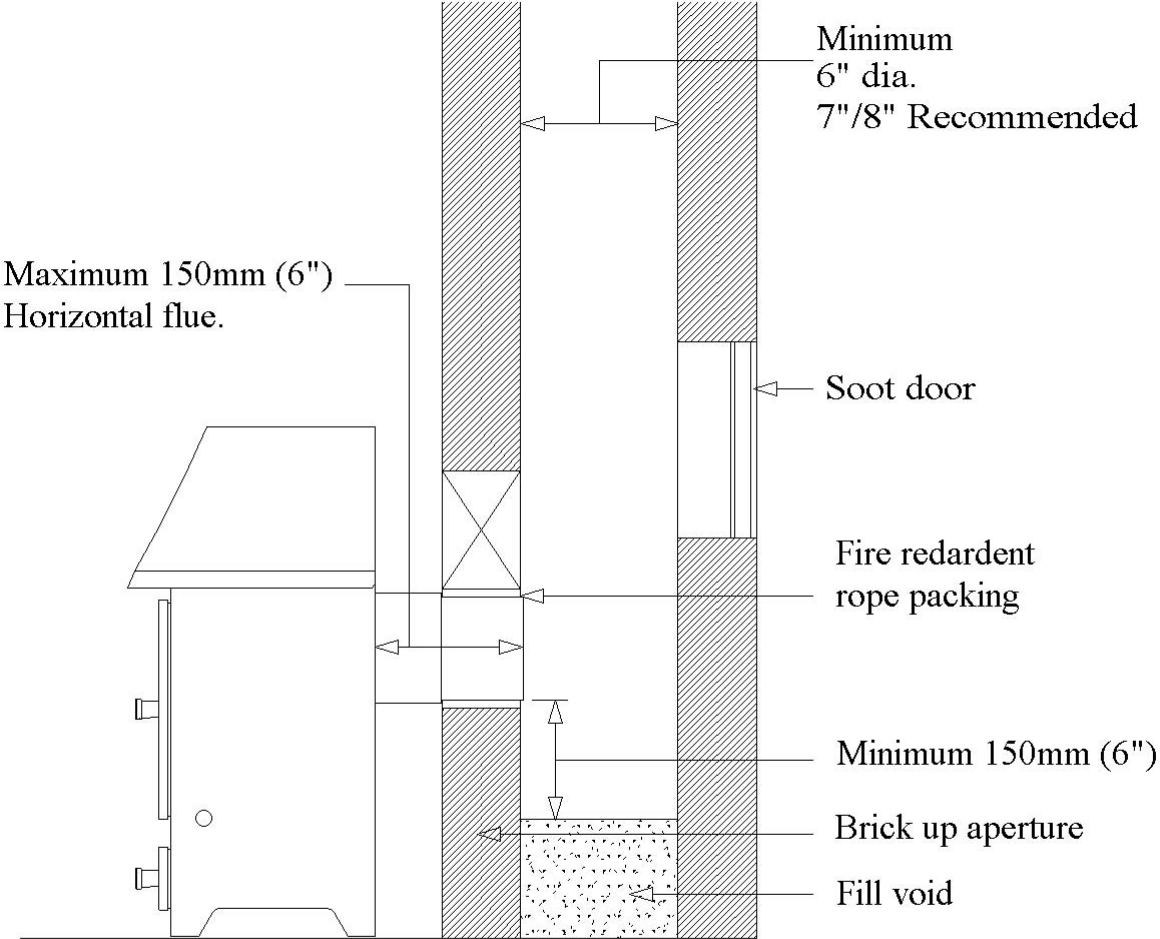

REAR FLUE OUTLET

# INSTALLATION

## TYPICAL METAL INSULATED CHIMNEY SYSTEM

TO BE INSTALLED TO THE CHIMNEY MANUFACTURERS INSTRUCTIONS IN COMPLIANCE WITH BUILDING REGULATIONS AND BS7566 Pts 1-4

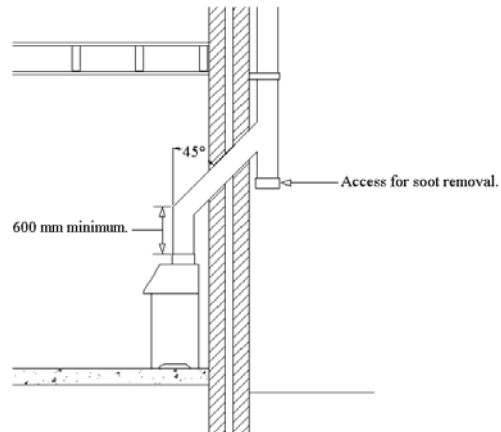
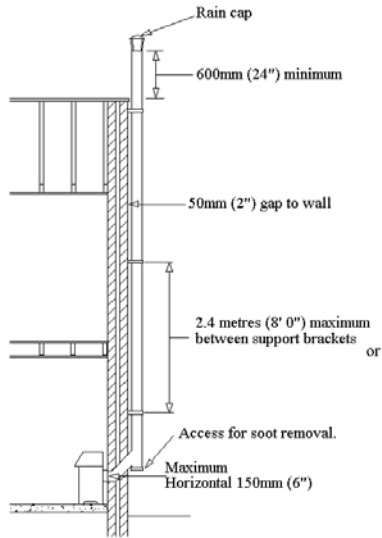

Plan view of steel register plate, 1.5mm thick minimum.

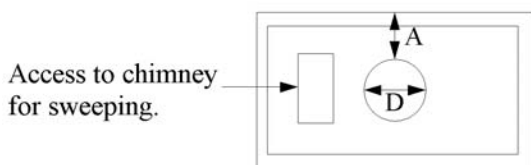

A: Minimum clearance for non-insulated flue =  
1.5 \* D to a non-combustible surface.  
3 \* D to a combustable surface.

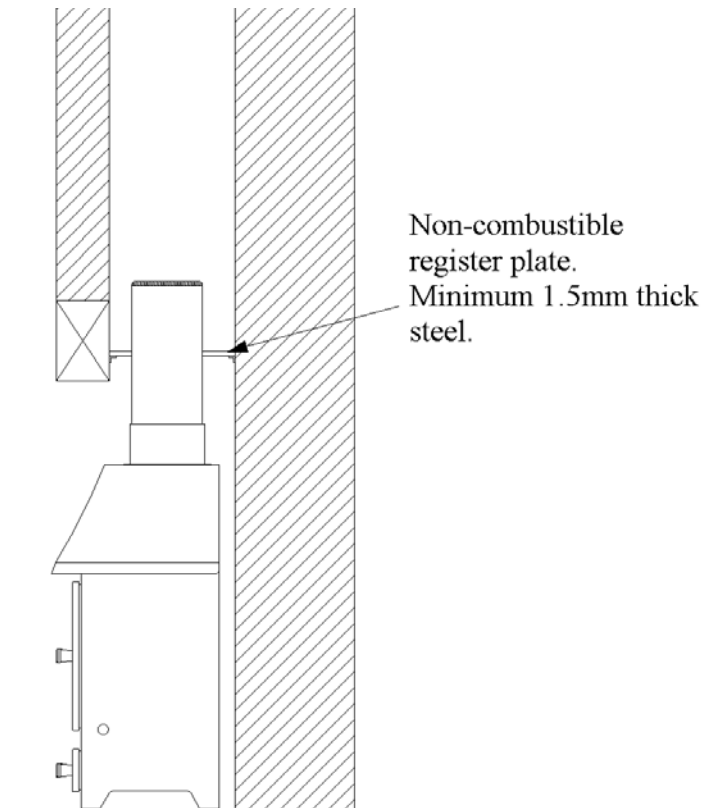

## TOP FLUE OUTLET

## FIREBOX LININGS AND THROAT PLATE

The Arden Multifuel stove firebox has reflective liners to the sides and rear and a specially shaped throat plate which sits on the liners. If these are not in place please refer to page 8 to install these.

## AIR INLET CONTROLS

The Arden multifuel stoves have two air inlets:

- The air wash system (so called because its pre-heated high speed air washes across the inner face of the door glass, keeping it clear), which provides over draught, and
- The primary air inlet providing under draught to the base of the fire chamber through controls on the bottom of the stove door.

## PRIMARY AIR FOR MULTIFUEL

Air enters the appliance through the control on the bottom of the fire doors. The Valor Arden has a single door control knob which slides left and right to increase or decrease the air intake.

## AIRWASH SYSTEM

The air wash has an internal sliding plate with slots, housed in a cover plate, and is located above the fire door. Sliding the control knob to the right as far as it will go achieves the fully open position. Sliding it to the left will shut off the air inlet slots As shown below.

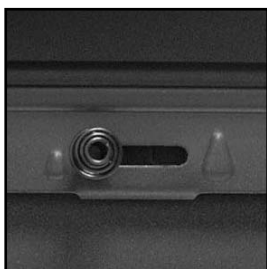

**Fig. 4 Fully Closed**



**Fig. 5 Fully Open**

Even when all the slots are completely shut a "bleed" of secondary air will be maintained ensuring that inflammable gases are burnt off.

## DISASSEMBLE AIRWASH

The top or bottom may be disassembled for cleaning or adjustment. To achieve this, the following procedure should be followed.

This should only be carried out when the fire is cold and unlit.

- Support Airwash cover with one hand
- Move cover up by smartly tapping the bottom with a hammer (Fig 6).
- Remove assembly from appliance
- Clean and/or adjust
- Refit using reverse procedure.



**Fig. 6**

## MULTI-PURPOSE OPERATING TOOL

Your Arden stove comes with a multi-purpose tool which is used to open the main fire door and to remove the ash pan Fig. 7)



**Fig. 7**

## OPERATING INSTRUCTIONS

---

### FIRE DOOR GLASS

In the event of the door glass being broken it can easily be replaced:

- The door should be lifted off the hinges so that the above operations can be carried out on a workbench or similar level surface. This should be done when the appliance is cold (fig.8)

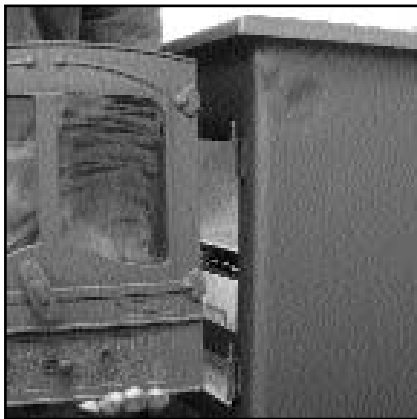

**Fig 8 removal of stove door**

- Unscrew the two nuts, on the inside of the door securing the retaining clips.
- Carefully remove any pieces of broken glass, and sealing gasket wearing suitable gloves.

### REFIT NEW GASKET

- The fitting of new gasket is shown below (fig.9a)



**Fig. 9a fitting new door gasket**

- Re-seat the new glass, ensuring the sealing gasket is flat and in contact with the glass.



**Fig 9b fitting new glass**

- Replace the two retaining clips and nuts. Do not over-tighten the nuts as damage may occur to the glass (fig.9c)



**Fig. 9c tightening nuts**

---

### ADJUSTING THE DOOR HINGES

Once the appliance has been under fire for a period of time the fire door may appear to have moved out of alignment with relation to the door aperture or catch. This is quite normal and due to the settling of the casing.

The fire door can be re-aligned by the user as follows:

- When the appliance is cold, open the fire door so that it is at right angles to the front of the fire.
- Lift the fire door up off its hinges (fig.8).

## OPERATING INSTRUCTIONS

---

- Gently tap the hinge pins in a direction to compensate for the misalignment (Fig. 10)



**Fig. 10 tapping door hinges**

- Refit the door and check to ensure it now sits square to the body; if not repeat above steps.

---

### FUEL TYPES

**Wood-** Any type of wood is suitable provided it is well seasoned and has a moisture content below 20%. This usually implies that the timber has been suitably stored to allow moisture to evaporate for at least nine months in the case of soft woods, and at least eighteen months in the case of hard wood. We recommend that for general burning, wood should be split into logs of no more than 130mm (5") diameter.

Larger logs can be used for overnight burning.

**WARNING** wet wood must not be used as this will greatly contribute to the creation of tar and creosote which may, in extreme cases, run down the chimney in liquid form. This will seriously damage both the chimney and the appliance, and increase the risk of chimney fire.

*Note: If you have sticky tar inside the appliance or chimney your wood is 'Green' or too wet.*

#### **Recommended Reading:**

"Wood as Fuel" available from the Forestry Commission.

**Peat-** Can be used in turf or briquette form, but again the moisture content must be low.

**Paper-** paper will burn successfully. Burn dry paper only or chimney damage will occur.

**NEVER BURN PLASTICS OR WASTE IN YOUR STOVE.**

**Coal for Multifuel only** - Household coal produces a large amount of ash and smoke and chimney will require frequent cleaning. Therefore soft house coal is **not** recommended.

*Recommended fuels are as follows:*

*The Hetas Ltd, "Three tick" appliance approval only covers the use of the following fuels in this appliance; Phurnacite, Phurnacite Plus, Centurion, Maxibrite, Extracite, Pureheat, Blazeprite, Taybrite, Sunbrite (double/singles), Anthracite (large nuts), and Welsh Dry Steam Coal (large/small nuts).*

*Approval does not cover the use of other fuels either alone or mixed with a suitable fuel listed above, nor does it cover instructions for use of other fuels.*

*Approval does not cover the use of other fuels either alone or mixed with a suitable fuel listed above, nor does it cover instructions for use of other fuels. For latest details please refer to Hetas website [www.hetas.co.uk](http://www.hetas.co.uk).*

**Do not use Homefire (six sided) and smaller sizes than Stovesse, e.g. Beans, Peas, Grains.**

**Do not use petroleum based solid products such as Calco or Petrocoke.**

**To do so will INVALIDATE the appliance guarantee.**

# OPERATING INSTRUCTIONS

---

## LIGHTING THE FIRE

**Prior to lighting the fire for the first time check with the installer that:**

- Installation and all building work is complete.
- The chimney is sound and has been swept and is free from obstruction.
- Adequate provision for combustion air has been made, i.e. a permanent vent of at least 550mm<sup>2</sup> per kW of rated output above 5 kW, is fitted in the room in which the appliance is installed.
- That Building Regulations and any local by-laws have been followed during installation (see installation instructions).
- All firebox liner panels are in place.
- Throat plate is in place.
- Where add in boilers are fitted ensure that the system is full of water and vented, and precautions have been taken to prevent corrosion (see installation Instructions).
- That the chimney draw has been checked and is within specification. With the chimney warm the draught should be between 1 - 2mm water gauge (0.1 - 0.2mbar).

**WARNING:** An over drawing chimney can cause over-firing resulting in damage to the appliance.

**WARNING ADD IN BOILERS:** Do not light the fire if it is suspected that any part of the water system is frozen.

**ENSURE THAT YOU HAVE READ & UNDERSTOOD THESE INSTRUCTIONS BEFORE LIGHTING THE FIRE.**

**ALWAYS WEAR SUITABLE PROTECTIVE FIRE GLOVES WHEN REFUELLING YOUR STOVE.**

### SOLID FUEL BURNING - Multifuel Stoves

- Ensure that the multifuel grate and ash pan are in position and the fire doors are closed.
- Set the air wash to one quarter open position.
- Set the primary inlet to the fully open position
- Light in the normal manner with paper and

kindling, or use a fire lighter.

- If using a gas poker be sure to remove it immediately the fire is alight.
- When the fire is well alight regulate the burning rate by adjusting the setting on the primary air inlet control.
- The air wash can be opened sufficiently to keep the door glass clean

### BURNING WOOD

- Set air wash to fully open position
- Proceed as for solid fuel but note the fire will burn up and become established more quickly.

### MIXED FUELS

- As per coal but allow additional secondary air.
- The primary air inlet can be closed and burning regulated by means of the air wash above the door.

### ANTHRACITE

Anthracite is more difficult to keep in for long periods, consequently more care in setting the controls and some familiarisation is necessary when burning anthracite.

Use the smallest size fuel (Stovesse or Small Nuts). Proceed as for manufactured smokeless fuel. Leave the air inlet control open about a quarter or less.

*Note: The high temperature paint acquires durability by being "cured" during the initial firings of the appliance will give off fumes which are non-toxic, but which certain persons may find have an unpleasant or irritant effect. Ensure that the area is well ventilated during this time.*



### OVERNIGHT BURNING

**The fire will burn overnight provided:**

- Sufficient fuel is placed in the firebox.
- The controls are set correctly.
- Excess draught is not present in the chimney.
- Close the door.
- If the fire goes out with unburnt fuel left in the firebox increase the air opening slightly, and vice versa.

### In the morning

- Open the air control fully until embers begin to glow brightly and place pieces of fuel on the fire until it is well established.

**WARNING:** When wood is burnt slowly in a closed appliance it produces moisture and tar, which will create condensation and deposits in the chimney. This effect can be minimised by burning hard for a short period, about 20 minutes, twice a day. It is usually convenient to do this morning and night.

*Note: To avoid chimney problems your fire should not be burnt slowly for longer than 12 hours without a period of fast burning.*

**WARNING:** *Properly installed, with a suitable flue and chimney and operated and maintained this appliance will not emit fumes into the dwelling. Occasional fumes from the de-ashing and re-fuelling may occur. However, persistent fume emission is potentially dangerous and must be investigated by a Hetas registered installer.*

**Stop using the appliance if you smell fumes or see smoke escaping.**

If fume emission does persist, the following immediate actions should be taken.

- Open doors and windows to ventilate room.
- Let the fire die or extinguish and safely dispose of fuel from the appliance.
- Check for flue or chimney blockage, and clean if required.

*Seek expert advice from your HETAS registered installer. Do not attempt to re-light the fire until the cause of the fume emission has been identified and corrected*

### ASH REMOVAL - Wood burner only.

The appliance will require ash to be removed periodically but an ash bed of approximately 20mm (3/4") should be maintained. Ash may be removed with a small shovel whilst the fire is still lit by raking the embers of a low fire to one side of the fire box and carefully removing the ash, then repeating the procedure for the other side. Care must be taken not to risk burning of hands or household objects from falling embers.

### DE ASHING - Multifuel Stoves only

It is necessary to maintain an ash layer on the upper surface of the grate bars, in order to protect them, so de-ashing should cease as soon as the first red embers drop into the ash pan. Further de-ashing will cause heat build-up under the grate, which will considerably shorten its life.

**TO EMPTY THE ASH PAN.** Open the fire doors. Fit the fork end of the operating tool into the ash pan and remove from the ash pit chamber.

**WARNING:** The ash can be very hot. Empty only to a metal container. Even if the ash appears cold, red-hot pieces of ash may be concealed and could easily start a fire or cause an injury.

### CLINKER

The formation of clinker suggests that the unit is being over-fired. Any clinker forming on the grate should be removed when cold

### OVER-FIRING

**Do not** over fire your appliance. Using flammable liquids or too much wood or firing the stove at maximum for prolonged periods may result in over-firing. If the chimney connector or casing glows red the appliance is being over-fired. If this occurs immediately close all air inlets to the appliance to reduce the air supply to the fire. Should a chimney fire occur immediately close the appliance down. Get everyone out of the house and call the fire brigade. A chimney fire may cause structural damage to the chimney. Do not use the appliance until the chimney and connector have been inspected and any damaged parts have been repaired or replaced. This should be done by a competent person such as a HETAS registered engineer.

## OPERATING INSTRUCTIONS

---

### CLEANING

Important; Under some circumstances soot can quickly build up on the throat plate and adjacent areas. The throat plate should be removed and checked monthly, and any debris stripped off. Similarly, clean the upper surface of the firebox.

### ANNUAL MAINTENANCE

*It is important that your fire is regularly serviced in accordance with these instructions. This should be carried out at least annually by a qualified person and should consist of the following.*

Remove the firebricks lining and throat plate, inspect all gasketing on doors, glass etc., and re-order any items that may need replacing, from your Valor dealer. With a wire brush clean inside the appliance paying particular attention to the small inlet holes of the air wash on the inside, above the fire door and to the door.

Sweep the chimney and confirm that it is sound. Examine all joints in the flue pipe etc., and re-seal if necessary. Reassemble and leave with the air inlet and air wash control about half way open. This will allow a free flow of air through the appliance thus preventing moisture and condensation from building up inside the fire and chimney.

### CHIMNEY SWEEPING

Sweeping should be carried out with an appropriate sized bristle brush and rods to suit chimney size and type. As with all appliances regular sweeping of the flue is essential to avoid the danger of blockage and the escape of poisonous fumes. Access for cleaning should also be incorporated in the chimney (e.g. soot door or access through register plate).

Any existing chimney should be swept prior to installation of the appliance, and swept again a second time **within one month** of regular use after installation to establish frequency of sweeping required. This should be done by a competent person such as a NACS chimney engineer who will provide a Certificate of Chimney Sweeping.

The whole flue way including the outlet must be swept at least twice per burning season. It is important that the flue ways, flue pipe and chimney be cleaned prior to lighting the fire after a prolonged shut-down period.

### DOOR GLASS

The door glass should remain clear during normal daytime burning. However under certain conditions-such as burning at a low rate with damp wood, or overnight burning, the glass may become somewhat blackened. To remedy this, operate the appliance at a fast rate. Alternatively when the stove is cold open the door and clean the inside face of the glass with a damp cloth or with glass cleaner (available from fire stockists). A piece of cloth moistened with vinegar and dipped in wood ash - **not coal ash** - will provide a good soft scourer to remove the soot without scratching the glass.

### OUTER FINISH

The outside finish of the appliance is a durable high temperature paint. It is best cleaned by brushing down with a clean shoe brush. Do not allow moisture to remain on the appliance whilst cold or surface rust may form.

The high temperature paint should not require attention for some time, depending on use. The hotter the fire burns the sooner repainting will be necessary. Aerosol tins of paint are available for complete refurbishing. Before repainting make sure that the fire is out and is cold.

- Remove the door glass.
- Lightly wire brush, or rub with wire wool, the body of the appliance to remove any loose paint powder.
- Mask or remove items such as brass work.
- Any adjacent brickwork, mantelpiece, hearth, etc., should be carefully masked for quite a distance around the appliance. (this precaution is to prevent discolouration of the surrounding brickwork, wallpaper etc).

**Re-spray in a well-ventilated area - avoid breathing the vapour. Refer to safety instructions on paint cans.**

- When the paint is dry refit door glass and any other parts previously removed.
- Leave the appliance for eight hours before-lighting.
- Burn slowly for the first four hours, then build up heat gradually to cure the paint.

***Note: Use only genuine Valor touch-up spray as some paints interact. This could ruin the finish and invalidate the guarantee.***

Your Valor Arden stove carries a guarantee against defects of manufacture and faulty workmanship for a period of one year from the date of purchase. This does not apply to items which would be subject to fair wear or tear. Firebox liner panels, fuel retainers, throat plate, door rope, door glass and gaskets are not covered by the guarantee. However, should you have any problems with your appliance please contact your Valor stockist who will have the knowledge and facilities to help you.

**Valor will not be responsible for any consequential or incidental loss, damage, or injury however caused.**

**USE OF SPARE PARTS OTHER THAN THOSE SUPPLIED BY VALOR WILL INVALIDATE THE APPLIANCE WARRANTY.**

All Guarantee periods commence on the date of purchase and are non-transferable. Our Guarantee is offered as an addition to your statutory rights.

Guarantee applicable to original purchaser only. not transferable.

This installation and operating manual gives sufficient details to enable the appliance to be installed and maintained. If further information is required, our **Valor Advice Line** will be pleased to help.

**Please telephone 08457 626341** (local rates apply)

When you contact them, they will need to know :

1. Your name, address, post code and telephone number.
2. Date of purchase and supplier details
3. Name of installer
4. Stove serial number
5. Clear and concise details of the fault.

**Please complete the following for you own records**

Date of Purchase.....Model..... Serial Number.....

Name and address of supplier.....  
.....  
.....

Name and address of Installer.....  
.....  
.....

# FINAL FACTORY CHECK LIST

---

Model.....
Serial No.....

QUALITY	
FINISH	
PARTS	
FLUE OUTLET	
HOT PLATE	
FUEL RETAINERS	
GRATE	
FIREBOX LININGS	
THROAT PLATE	
AIR WASH	
DOOR CATCHES	
FEET & FIXINGS	
ASH PAN	
OPERATING TOOL	
OPERATING INSTRUCTIONS	

*I've checked it  
and it's O.K.*

Assembled by.....

Checked by .....



Valor Heating, Erdington, Birmingham, B24 9QP

---