Hamlet

Multifuel Stove



Valor Hamlet Multifuel Stove

PLEASE RETAIN THESE INSTRUCTIONS FOR FUTURE REFERENCE

Baxi Fires Division,
Wood Lane,
Erdington,
Birmingham
B24 9QP

Tel. 08706 061 064
Fax. 0121 373 8181
www.firesandstoves.com

Rev 1
July 2006
AFS1283

WARNING

TO ALL MULTIFUEL USERS

PETROLEUM COKE

SOME OF WHOSE BRAND NAMES ARE

"CALCO", "PETROCOKE" OR "WONDERCO"

MUST NOT BE BURNED IN THIS APPLIANCE

TO USE THESE FUELS WILL INVALIDATE THE
APPLIANCE GUARANTEE

**IF IN DOUBT CONTACT THE SOLID FUEL ASSOCIATION
TELEPHONE NUMBER 0800 600 000**

www.solidfuel.co.uk

**THE USE OF SPARE PARTS OTHER THAN THOSE SUPPLIED
BY VALOR WILL INVALIDATE THE
APPLIANCE GUARANTEE.**

CONTENTS

Section Content	Page	Section Content	Page
Safety	4	Fire Door Glass	16
The Principle of the Fire	4	Door Adjustment	17
Check List	5	Fuel Retaining Bars	17
Technical Data	6	OPERATING INSTRUCTIONS	
INSTALLATION		Fuel Types	18
General Precautions	7	Lighting The Fire	19
Handling	7	Air Inlet Controls	20
Hearth	7	Primary Air	20
Combustible Materials	7	Air Wash System	20
Air For Combustion	7	Multi-Purpose Operating Tool	20
Fitting The Flue Spigot Outlet & Hot Plate	8	Setting The Grate	20
Flues & Chimneys	8-9	To Empty The Ashpan	20
For All Appliances	9-11	De-Ashing (Riddle)	21
Firebox Liner Panels & Throat Plate Assembly	12	Adjusting Air Inlet Controls	21
Multifuel Grate	13	Main Fire Door Handle	21
SERVICING & MAINTENANCE		Over-Firing	22
Cleaning - Internal Surfaces	14	Ash Removal	22
Cleaning - Outer Finish	14	Extended Burning	22
Door Glass	14	Spare Parts List	23-25
Chimney Sweeping	14	GUARANTEE	26
Annual Maintenance	15	SERVICE RECORD	27
Summer Storage / Non Usage	15	FINAL FACTORY CHECKLIST	28
Disassemble Airwash	15-16		

SAFETY

A fireguard conforming to BS 8423: 2002 should be used in the presence of children and old/or infirm people. If the appliance is used with the fire door open, a spark guard conforming to BS 3248 should be fitted.

Do not use aerosol sprays or any other flammable products near the appliance under fire.

Do not fit an extractor fan in the same room as the appliance.

Fire cement is caustic, hand and eye protection should always be worn, prolonged contact with the skin should be avoided.

Valor will not be responsible for any consequential or incidental loss or injury however caused.

Before continuing any further with the installation of this appliance please read the following guide to manual handling.

- Always obtain assistance when lifting the appliance.
- When lifting always keep your back straight. Bend your legs not your back.
- Avoid twisting at the waist. It is better to reposition your feet.
- Avoid upper body/top heavy bending. Do not lean forwards or sideways when handling the fire.
- Always grip with the palms of your hands. Do not use fingertips for support.
- Always keep the stove as close to the body as possible. This will minimise the cantilever action.
- Use gloves to provide additional grip.

THE PRINCIPLE OF THE FIRE

Your Valor stove is built to the highest standard of craftsmanship using the best materials and the most modern equipment available. It is a highly efficient and sophisticated piece of machinery and when properly installed and operated it should provide a lifetime of heating satisfaction.

Safety is the most important consideration when installing your fire. If not properly installed and

operated a house fire may result. Installation must comply with the Building Regulations and conform to all relevant fire safety standards.

All fire doors are fitted with special high temperature ceramic glass panels through which the fire can be viewed.

Multifuel stoves are fitted with a cast iron grate to give full multifuel facility and positive de-ashing with the main fire doors closed thus preventing ash dust entering the room.

All models are lined with firebricks or heat reflective panels which ensure complete combustion and provide a good heat store to even out fluctuations in burning.

An internal throat plate produces turbulence to encourage secondary combustion and directs the flue gas around the whole upper firebox before allowing it to escape up the chimney.









On multifuel appliances the primary air for burning enters the ash pit chamber beneath the grate, controlled by the air inlet mechanism.

Valor stoves are fitted with an "air wash" so called because it provides a curtain of high speed preheated air behind the glass to help keep it clean and to provide secondary air/over draught.

The provision of two inlets on all multifuel stoves gives a wide range of primary air/secondary air, under draught/over draught combinations.

The optimum settings will only be established by experience in firing the appliance, and will depend on type of fuel, the position of the appliance in the house, condition of chimney etc.

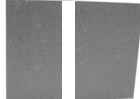
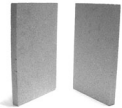
CHECK LIST

Part Description & Visual Aid (not to scale)	Valor Hamlet Multifuel
1. Grate bars 	7
2. Fuel retainers 	2
3. Throat plate 	1
4. Flue spigot 	1
5. Hotplate 	1
6. Ashpan 	1
7. Operating tool 	1
8. Rear liners 	2
9. Side liners 	2
10. Instructions 	1
11. Stove Mitten 	1

TECHNICAL DATA

TECHNICAL DATA	Valor Hamlet Multifuel
Room Min/Max Room Heater Only Output (kW)	1.5 - 6
Height (mm)	535
Width (mm)	485
Depth (mm)	390
Height to Centre of Rear Flue	430
Depth from Back to Centre of Flue (mm)	120
Flue Diameter	127 (5")
Weight Packed (Kg)	64 Kg
Ideal Log Length (mm)	300

GENERAL PRECAUTIONS

Note - All installations must conform to the appropriate building regulations.

The Building Regulations for England and Wales 2000 ref Approved Document J 2002 edition (issued by the DTLR).

The Building Standards (Scotland) (Consolidation) Regulations.

Detailed recommendations for installation of appliances, chimneys and flues are outlined in the current issue of the following British Standards:- BS6461, BS8303 and BS4543.

Any Manufacturer's Instructions must not be taken as overriding statutory requirements.

During installation ensure that adequate precautions are taken to avoid unnecessary risk to yourself or any householder. In particular the danger from the caustic nature of the fire cement should be avoided by using these accepted methods:

- Wear gloves when handling fire cement.
- Wear goggles when chiselling or looking up chimneys.

Make sure that Building Regulations are adhered to during installation along with any local by-laws.

HANDLING

By the time you read this you will appreciate the weight of the appliance. The Safety and handling guidelines as set out on page 4 of this manual should be followed.

To make movement easier internal fittings, fuel retainers, grates, firebox liners, flue outlets, hot plate, throat plate, etc., can be removed.

Care should be taken to make sure that the hinges are not damaged during installation.

HEARTH

The fire should be installed to stand on a constructional hearth of non-combustible materials

not less than 125mm (5") thick conforming to Building Regulations. Dimensions of the hearth should project at least 300mm (12") forward of the front of the appliance and 150mm (6") at the sides. The surface of the hearth should be free of combustible materials. In most buildings with solid concrete floors the requirement will be met by the floor itself, but mark the perimeter of the hearth to ensure floor coverings are kept well away or use different levels to mark the hearth perimeter.

COMBUSTIBLE MATERIALS

A gap of at least 450mm (18") should be allowed between the appliance and any combustible materials including furnishings. Adjacent walls should be of suitable non-combustible construction, preferably brickwork. In large fireplaces take care that any supporting beam is protected by a 13mm (0.5") sheet of Masterboard/Supalux spaced 13mm (0.5") off the surface with strips of non-combustible material - not wood.

Make sure that there is a gap between an uninsulated flue system and any combustible material. This gap must be at least 3 x the outside diameter of the flue pipe, or 1.5 x the flue diameter to non combustible surfaces. see illustration p11.

AIR FOR COMBUSTION

There must always be a permanent means of providing air for combustion into the room in which the fire is installed. A permanent vent with a total free area of at least 550mm² for every kW rated output above 5kw should be connected directly to the outside air or to an adjacent room which itself has a permanent vent of the same size direct to the outside air. The fitting of an extractor fan to either of these rooms is not recommended.

Note: if the appliance is fitted with a draught stabiliser or if one is fitted to the flue pipe or chimney in the same room as the appliance, then the permanent air entry opening (or openings) should be increased by 300mm² for each kW of rated output.

INSTALLATION

FITTING THE FLUE SPIGOT OUTLET AND HOT PLATE

The flue spigot outlet is found packed inside the appliance. The hot plate (blanking plate) is supplied fitted to the top opening and is removed by turning clockwise (as is the flue outlet).

Smear a very thin layer of fire cement on the faces of the flue outlet and the blanking plate. Fit the outlet to the appliance in the desired position.

Lock into place by rotating anti-clockwise and tighten by tapping the lugs of the casting with a block of wood and mallet. This can be done, from inside the appliance. Similarly, fit the blanking plate to the unused opening. Clean off any surplus fire cement.

Place appliance on the hearth and make sure that it is level and does not rock.

Connect the chimney ensuring all joints are sealed with fire cement.

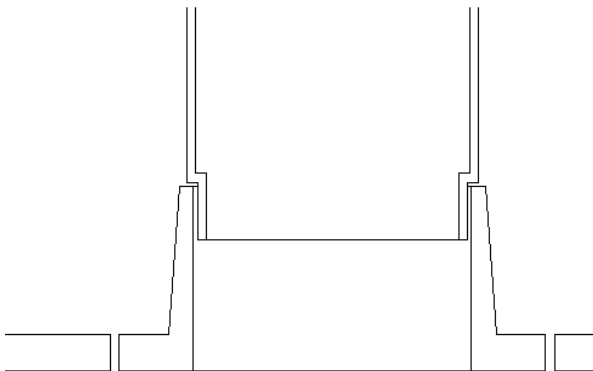

*NOTE

THE FLUE PIPE MUST BE FITTED INSIDE THE OUTLET SPIGOT
FAILURE TO DO SO COULD RESULT IN THE SPILLAGE OF
CONDENSATION ETC. RUNNING DOWN THE FLUE.

Fig. 1. Flue and Spigot Fitting

FLUES AND CHIMNEYS

Please remember that chimney draught is dependent on four main factors:

- Flue gas temperature.
- Flue height.
- Flue size.
- Flue terminal.

The stove must be connected to a suitable and efficient flue that provides a good updraught to safely take the products of combustion (fumes) from the stove outlet to the outside air. To ensure a good updraught it is important that the flue gases are kept warm and that the flue size suits the stove.

The termination of the outlet at the top of the flue also needs to comply with the Building Regulations. The minimum effective height of the flue must be at least 4.5 metres from the top of the stove to the top of the flue outlet. When warm the flue draught should be between 0.1 and 0.2 mb.

A chimney may comply with the regulations but still be subject to down draught and similar problems. A chimney terminating above the ridge level is generally less likely to suffer such problems.

If a new chimney is being provided it should fully comply with the relevant Building Regulations that specify the requirements for solid fuel burning installations. Suitable types of chimney include the following.

Masonry chimney built with clay or concrete liners, or a chimney block system meeting Building Regulations. These types of chimney should be installed in accordance with the Building Regulations and BS 6461: Part 1.

Factory made insulated chimney complying with BS 4543: Part 2 (often called "Class 1 prefabricated metal chimney"). These types of chimney should be installed in accordance with the Building Regulations and BS 7566: Parts 1 to 4.

Due to the gradual introduction of European Chimney Standards chimneys will be specified according to their performance designation as defined in BS EN 1443 that covers the General Requirements for chimneys. The minimum performance designation required for use with solid fuel burning stoves is T450 N2 S D3.

The flue and chimney installation must be carefully checked by a competent person before fitting the stove to ensure it is suitable and will work safely.

If the chimney is old (ie built of brick or stone without a liner) or being opened up for reuse additional checks and smoke testing as described in Appendix E of the Approved Document J 2002 Edition should also be carried out to ensure the flue and chimney are in good operating condition.

Unless the existing flue is in good condition with suitable access for collection and removal of debris. If the flue size is more than 225mm (9 inches) diameter or 200 x 200mm square, a suitable liner of 150mm (6 inches) diameter should be fitted, or if the flue length is over 5.5 metres one size larger than the appliance outlet should be fitted. This should be a double skin stainless steel flexible flue liner that is independently certified for use with solid fuel. Details of suitable linings for use with solid fuel are given in the Official HETAS guide that can be viewed on their website at www.hetas.co.uk

It is also important that suitable flue pipe complying with the Building Regulations is used to connect the stove to the flue in the chimney and that suitable access is provided into the flue for regular inspection and sweeping of the flueways.

The installer should comply with the Building Regulation requirements in respect of providing a Notice Plate giving details on the chimney, flue lining, hearth and fireplace installation. Approved Document J of the Building Regulations for England and Wales is available from The Stationery Bookshops and can also be viewed at the ODPM website at www.safety.odpm.gov.uk/bregs/brads.htm

Details on the relevant Building Regulations and BS British Standards are given in the "General

Precautions" section page 7 of these instructions.

Chimneys should be as straight as possible. Horizontal runs should be avoided except where the rear outlet of the appliance is used, in which case the horizontal section should not exceed 150mm (6") in length.

If the fire appears to be working hard but produces very little output to the room it is likely that excessive draw is present in the chimney, and that heat is being sucked out of the appliance and up the chimney. If this is the case we recommend the fitting of a draught stabiliser in preference to a flue damper, in the interest of safety and efficiency.

We do not recommend the use of a damper when burning solid fuel.

FOR ALL APPLIANCES

Access for cleaning the flue should be incorporated in the system other than through the appliance (e.g. a soot door or access through register plate). Purpose-made soot doors and inspection lengths are available from manufacturers of all systems.

Ensure that the whole length of the flue can be reached from the soot door.

Note: if the appliance is fitted with a draught stabiliser or if one is fitted to the flue pipe or chimney in the same room as the appliance, then the permanent air entry opening (or openings) should be increased by 300mm² for each kW of rated output.

**For advice on flues and chimneys contact;
NACE (National Association of Chimney Engineer): telephone 0800 0924019
www.nace.org.uk**

**or
NACS (National Association of Chimney Sweeps): telephone 01785 811732
www.chimneyworks.co.uk**

INSTALLATION

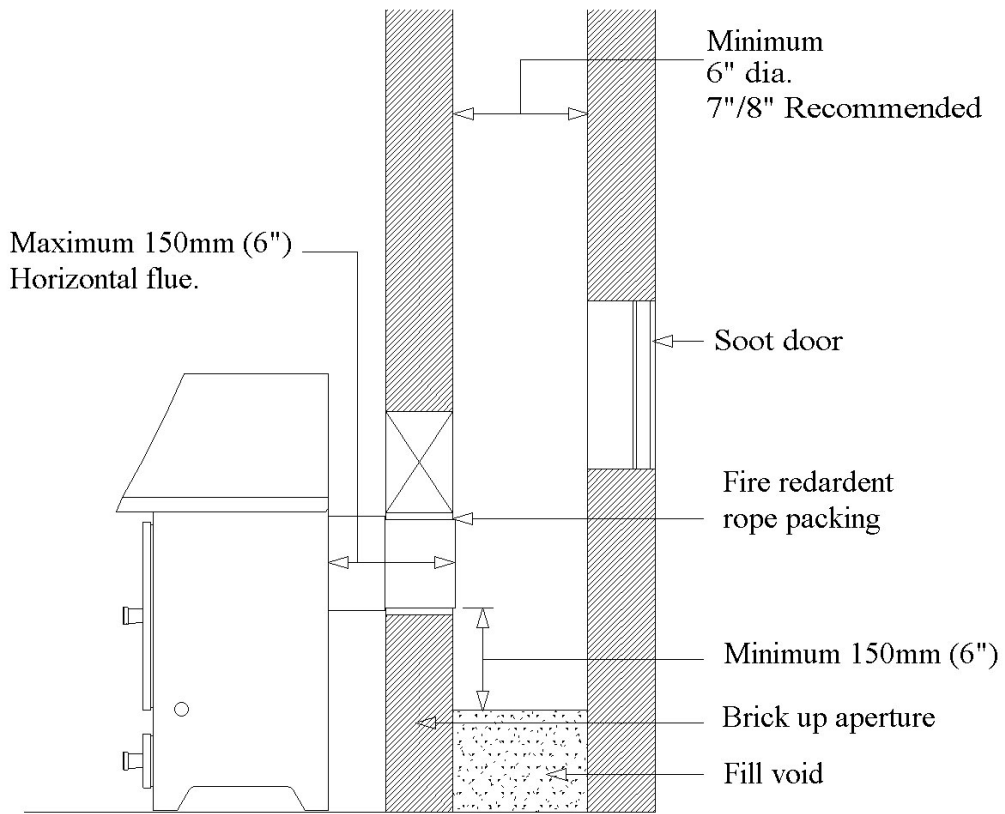

REAR FLUE OUTLET

Fig. 2. A Typical Rear Flue Layout

TYPICAL METAL INSULATED CHIMNEY SYSTEM
 TO BE INSTALLED TO THE CHIMNEY MANUFACTURERS INSTRUCTIONS IN COMPLIANCE
 WITH BUILDING REGULATIONS AND BS7566 Pts 1-4

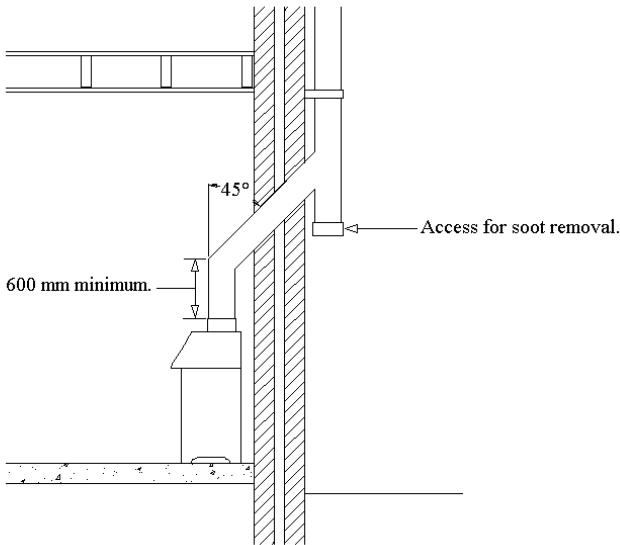
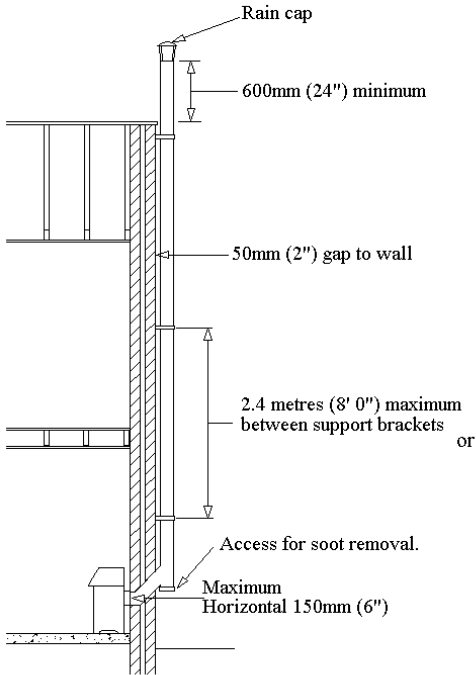

PLAN VIEW OF REGISTER PLATE AND CLEARANCES FOR NON INSULATED FLUES

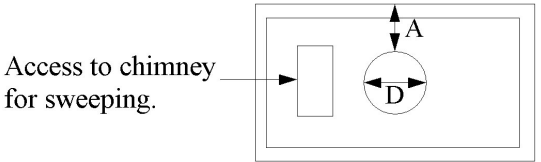

A is minimum clearance for non-insulated flue =
 1.5 x D to a non-combustible surface/material
 or
 3 x D to combustible surface/material

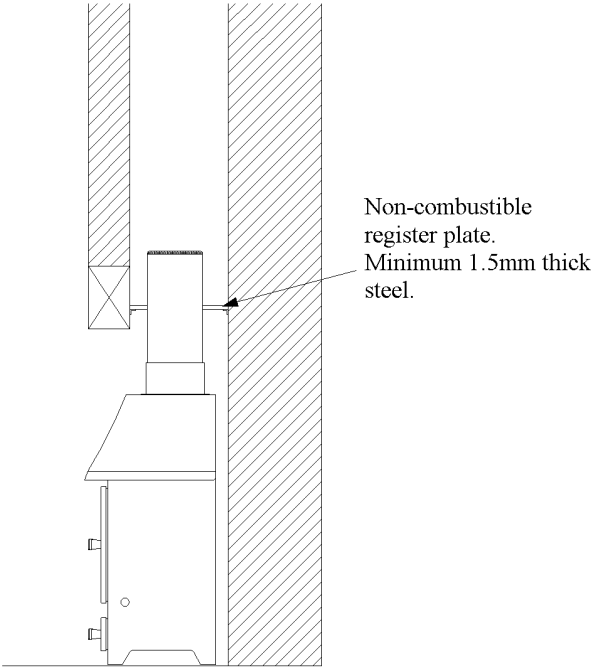

TOP FLUE OUTLET

Fig. 3. A Typical Top Flue Layout

INSTALLATION

FIREBOX LINER PANEL & THROAT PLATE ASSEMBLY

The Valor Hamlet multifuel stove uses reflective liners to the sides and back of the firebox. A throat plate sits on top of the side and rear panels. These should come fitted to your fire, if however they are not, proceed as follows to fit them.

- Remove the two round front fuel retaining bars , by lifting one end free of the bracket and sliding the remaining end out from the bracket.
- Set the small liners into the back of the fire.
- Insert the side liner panels, see figure 5.
- Fit the throat plate with the single bend and two cut outs to the front facing up. The projecting lugs sit on top of the side liners. The long centre tab on the back edge rests on the rear liners. The shorter turn-down tabs against the vertical face. See figure 4 and 6.
- Replace the front fuel retainer bars.

Note: Neither the rear firebox liners nor the side firebox liners are "handed", both faces are suitable for direct contact with the fire.

Note: Cracking of lining panels does not effect efficiency.

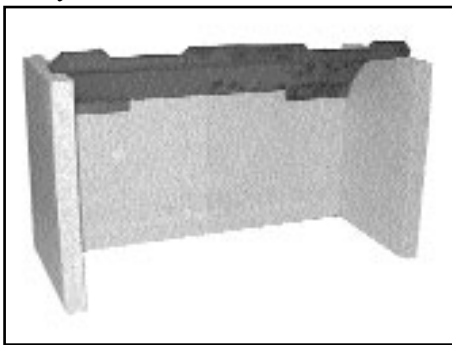

Fig. 4. Valor Hamlet Multifuel liners and throat plate.

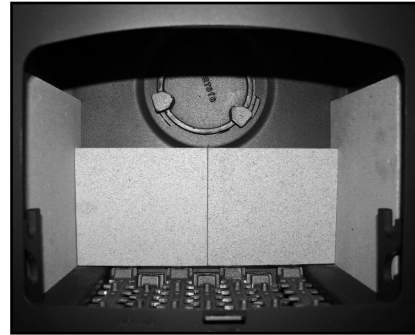

Fig. 5. Liners inserted in the Valor Hamlet Multifuel.



Fig. 6. Inserting Throat Plate in to the Valor Hamlet Multifuel.



Fig. 7. Liners, throat plate and grate in the Valor Hamlet multifuel.

MULTIFUEL GRATE

GRATE

The grates in the Valor Hamlet stove, comprises of a series of reciprocating cast iron grate bars seated on a pivoting "comb". All bars in the grate are identical, but every other bar is turned through 180 degrees, with the ends of the bars marked "H" sitting on the high sections of the comb, and the ends marked "L" sitting on the low sections.

ASSEMBLING THE GRATE

To assemble the grate, fit bars to low sections of the comb first, inserting end marked "H" into rear channel with groove on underside of bar located on upstand tab, and then lowering end marked "L" onto the low section of the comb, see fig. 8. The upper bar is fitted in a similar manner, but with the end marked "L" inserted in the rear channel, and the end marked "H" seated on the high section of the comb. See fig. 9. for the assembled grate layout.

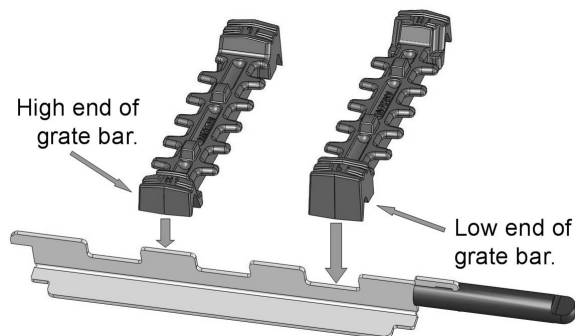

Fig. 8. Fitting The Grate Bars

GRATE BAR REPLACEMENT

After extended use it may be necessary to replace some of the grate bars. Periodic inspection of the bars is recommended and the removal of any nails or wire that may be present after burning wood.

All the grate bars in the appliance are identical and can easily be lifted out, after removal of the fuel retaining bars. Remove damaged grate bars and replace with casting of the same type, fitting as per instruction above. When re-ordering replacement grate bars, see page 23 of these instructions for the correct spare part code.

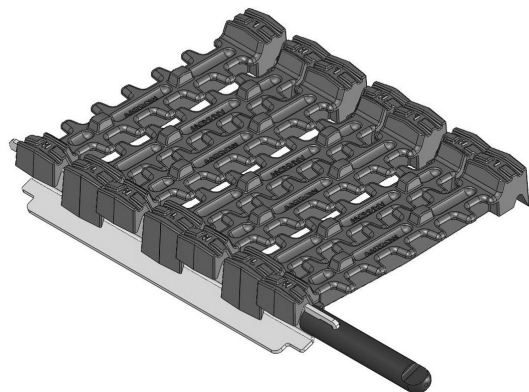

Fig. 9. Assembled Grate

SERVICING & MAINTENANCE

CLEANING

INTERNAL SURFACES

IMPORTANT -

Under some circumstances soot can quickly build up on the throat plate and adjacent areas. The throat plate should be removed and checked monthly, and any debris stripped off. Similarly, clean the upper surface of the firebox.

Refer to page 12 for instructions on throat plate removal/inspection.

OUTER FINISH

The outside finish of the appliance is a durable high temperature paint. It is best cleaned by brushing down with a clean shoe brush. Do not allow moisture to remain on the appliance whilst cold or surface rust may form.

The high temperature paint should not require attention for some time, depending on use. The hotter the fire burns the sooner repainting will be necessary. Aerosol tins of paint are available for complete refurbishing. Before repainting make sure that the fire is out and is cold.

- Remove the door glass.
- Lightly wire brush, or rub with wire wool, the body of the appliance to remove any loose paint powder.
- Mask or remove items such as brass work.
- Any adjacent brickwork, mantelpiece, hearth, etc., should be carefully masked for quite a distance around the appliance. (this precaution is to prevent discolouration of the surrounding brick work, wallpaper etc).

Re-spray in a well-ventilated area - avoid breathing the vapour. Refer to safety instructions on paint cans.

- When the paint is dry refit door glass and any other parts previously removed.
- Leave the appliance for eight hours before re-lighting.
- Burn slowly for the first four hours, then build up heat gradually to cure the paint.

Note: Use only genuine Valor touch-up spray as some paints interact. This could ruin the finish and invalidate the guarantee.

DOOR GLASS

The door glass should remain clear during normal daytime burning. However under certain conditions-such as burning at a low rate with damp wood, or overnight burning, the glass may become somewhat blackened. To remedy this, operate the appliance at a fast rate. Alternatively when the stove is cold open the door and clean the inside face of the glass with a damp cloth or with glass cleaner (available from fire stockists). A piece of cloth moistened with vinegar and dipped in wood ash - **not coal ash** - will provide a good soft scourer to remove the soot without scratching the glass.

CHIMNEY SWEEPING

Sweeping should be carried out with an appropriate sized bristle brush and rods to suit chimney size and type. As with all appliances regular sweeping of the flue is essential to avoid the danger of blockage and the escape of poisonous fumes. Access for cleaning should also be incorporated in the chimney (e.g. soot door or access through register plate).

Any existing chimney should be swept prior to installation of the appliance, and swept again a second time **within one month** of regular use after installation to establish frequency of sweeping required. This should be done by a competent person such as a NACS chimney engineer who will provide a Certificate of Chimney Sweeping.

Sweep the whole flue way, including the outlet, at least twice per burning season. It is important that the flue ways, flue pipe and chimney be cleaned prior to lighting the fire after a prolonged shut-down period.

If any damage or doubt over the flue or chimney exists, **Do Not** use the appliance until the chimney and connector have been inspected and any damaged parts repaired or replaced. This should be done by a competent person such as a HETAS registered engineer.

ANNUAL MAINTENANCE

It is important that your fire is regularly serviced in accordance with these instructions. This should be carried out at least annually by a qualified person and should consist of the following.

Remove the firebricks lining and throat plate, inspect all gasketing on doors, glass etc., and re-order any items that may need replacing, from your Valor dealer. With a wire brush clean inside the appliance paying particular attention to the small inlet holes of the air wash on the inside, above the fire door and to the door.

Sweep the chimney and confirm that it is sound. Examine all joints in the flue pipe etc., and re-seal if necessary.

SUMMER STORAGE/NON USAGE

Please ensure that your stove is left clean and moving components are well lubricated for the summer months (during periods of prolonged non-use). If possible store the throat plate outside the stove, check all moveable components, at regular intervals, to ensure they are moving freely.

Allow air movement through the stove, by opening the airwash and primary air inlets controls to about half way open or leave the door ajar. This will allow a free flow of air through the appliance thus preventing moisture and condensation from building up inside the fire and chimney. This should ensure it stays in the best condition for the coming winter months.

DISASSEMBLE AIRWASH

The air wash may be disassembled for cleaning or adjustment. To achieve this, the following procedure should be followed:

This should only be carried out when the fire is cold and unlit.

- Unscrew (Anti-clockwise) the airwash control knob, see Fig. 10.
- Move cover up by tapping each end of the front cover.
- Lift cover free from body, being careful to not damage the ends of each lug on the cover see Fig. 11.
- Slide off the spacer from the centre stud and retain for re-assembly.
- Unscrew the inner slider and clean / replace, see Fig. 12.(Page 16)
- Refit using the reverse of this procedure.

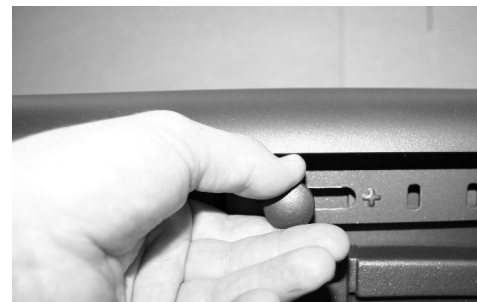

Fig. 10. Unscrew Knob



Fig. 11. Outer Cover Removal

SERVICING & MAINTENANCE



Fig. 12. Inner Slider Removal

FIRE DOOR GLASS

In the event of the door glass being broken it can easily be replaced. This should be done when the appliance is cold and unlit:

- The door(s) should be lifted off the hinges so that the below operations can be carried out on a workbench or similar level surface.
- Unscrew the hex bolts on the inside face of the door, using a 8mm socket or spanner. Remove the retaining clips, see Fig. 13.
- Carefully remove any pieces of broken glass, and sealing gasket wearing suitable gloves.
- Re-place the gaskets and line them up in relation to the door frame. See Fig.13.

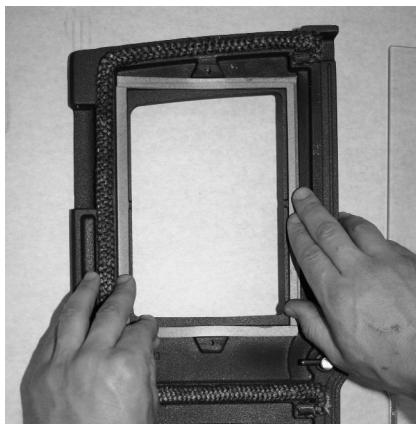

Fig. 13. Lining up the gasket

- Re-seat the new glass, ensuring the sealing gasket is flat and in contact with the glass. See Fig.14.



Fig. 14. Fitting The Glass

- Replace the two retaining clips and bolts. Do not over-tighten the bolts as damage may occur to the glass, see Fig. 15. Re-place the door(s) carefully over the hinges and slot in place.

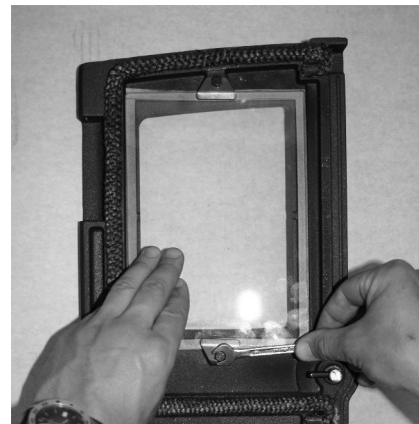

Fig. 15. Tightening The Glass Clips

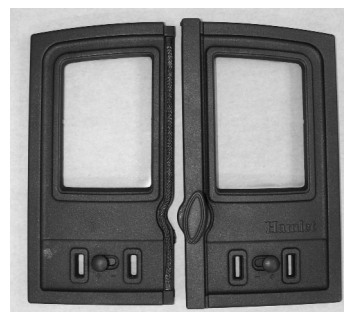

Fig. 16. Finished Door Assembly

DOOR ADJUSTMENT

Once the appliance has been under fire for a period of time the fire door may appear to have moved out of alignment with relation to the door aperture. This is quite normal and due to the settling of the casing.

The fire door can be re-aligned by the user as follows:

- When the appliance is cold, open the fire door so that it is at a right angle to the front face of the stove.
- Lift the fire door up off the hinges.
- Check that the hinge screws are tight and secure.
- Gently tap the two hinge pins in a direction to compensate for the misalignment, see fig. 17.
- Refit the door and check to ensure it now sits square to the body and the central gap between each door is even, if not repeat above steps.



Fig. 17. Adjusting The Door Hinges

FUEL RETAINER BARS

Fuel retainer bars are supplied with the stove. Slide and lift the bar until it is clear of the guides at each side, and remove through the fire door opening. The bars are symmetrical and of even lengths making incorrect fitting impossible.

Periodically check for any bowing or heat warpage to the fuel retaining bars and replace as necessary.

Note: This operation should only be carried out when the appliance is cold and unlit.

OPERATING INSTRUCTIONS

FUEL TYPES

Wood- Any type of wood is suitable provided it is well seasoned and has a moisture content below 20%. This usually implies that the timber has been suitably stored to allow moisture to evaporate for at least nine months in the case of soft woods, and at least eighteen months in the case of hard wood. We recommend that for general burning, wood should be split into logs of no more than 130mm (5") diameter.

Larger logs can be used for overnight burning.

WARNING wet wood must not be used as this will greatly contribute to the creation of tar and creosote which may, in extreme cases, run down the chimney in liquid form. This will seriously damage both the chimney and the appliance, and increase the risk of chimney fires.

Note: If you have sticky tar inside the appliance or chimney your wood is 'Green' or too wet.

Recommended Reading:

"Wood as Fuel" available from the Forestry Commission.

Peat- Can be used in turf or briquette form, but again the moisture content must be low.

Paper- paper will burn successfully. Burn dry paper only or chimney damage will occur.

NEVER BURN PLASTICS OR WASTE IN YOUR STOVE.

Coal for Multifuel only - Household coal produces a large amount of ash and smoke and your chimney will require frequent cleaning. Therefore soft house coal is **not** recommended.

Recommended fuels are as follows:

The Hetas Ltd, "Three tick" appliance approval only covers the use of the following fuels in this appliance; Phurnacite, Phurnacite Plus, Centurion, Maxibrite, Extracite, Pureheat, Blazebright, Taybright, Sunbright (double/singles), Anthracite (large nuts), Ancit and Welsh Dry Steam Coal (large/small nuts).

Approval does not cover the use of other fuels either alone or mixed with a suitable fuel listed above, nor does it cover instructions for use of other fuels. For latest details please refer to Hetas website www.hetas.co.uk.

Do not use Homefire (six sided) and smaller sizes than Stovesse, e.g. Beans, Peas, Grains.

Do not use petroleum based solid products such as Calco or Petrocoke.

To do so will INVALIDATE the appliance guarantee.

LIGHTING THE FIRE

Prior to lighting the fire for the first time check with the installer that:

- Installation and all building work is complete.
- The chimney is sound and has been swept and is free from obstruction.
- Adequate provision for combustion air has been made, i.e. a permanent vent of at least 550mm² per kW of rated output above 5 kW, is fitted in the room in which the appliance is installed.

Note: if the appliance is fitted with a draught stabiliser or if one is fitted to the flue pipe or chimney in the same room as the appliance, then the permanent air entry opening (or openings) should be increased by 300mm² for each kW of rated output.

- That Building Regulations and any local by-laws have been followed during installation (see installation instructions).
- All firebox liner panels are in place.
- Throat plate is in place.
- That the chimney draw has been checked and is within specification. With the chimney warm the draught should be between 1 - 2mm water gauge (0.1 - 0.2mbar).

WARNING: An over drawing chimney can cause over-firing resulting in damage to the appliance.

ENSURE THAT YOU HAVE READ & UNDERSTOOD THESE INSTRUCTIONS BEFORE LIGHTING THE FIRE.

ALWAYS WEAR SUITABLE PROTECTIVE FIRE GLOVES WHEN REFUELLING YOUR STOVE.

SOLID FUEL BURNING

- Ensure that the multifuel grate and ash pan are in position and the fire doors are closed.
- Set the air wash to one quarter open position.
- Set the primary inlet to the fully open position
- Light in the normal manner with paper and

kindling, or use a fire lighter.

- If using a gas poker be sure to remove it immediately the fire is alight.
- When the fire is well alight regulate the burning rate by adjusting the setting on the primary air inlet control.
- The air wash can be opened sufficiently to keep the door glass clean.

BURNING WOOD

- Set air wash to fully open position
- Proceed as for solid fuel but note the fire will burn up and become established more quickly.

MIXED FUELS

- As per coal but allow additional secondary air.
- The primary air inlet can be closed and burning regulated by means of the air wash above the door.

ANTHRACITE

Anthracite is more difficult to keep in for long periods, consequently more care in setting the controls and some familiarisation is necessary when burning anthracite.

Use the smallest size fuel (Stovesse or Small Nuts). Proceed as for manufactured smokeless fuel. Leave the air inlet control open about a quarter or less.

Note: The high temperature paint acquires durability by being "cured" during the initial firings of the appliance will give off fumes which are non-toxic, but which certain persons may find have an unpleasant or irritant effect. Ensure that the area is well ventilated during this time.

OPERATING INSTRUCTIONS

AIR INLET CONTROLS

The Valor Hamlet multifuel stove has two air inlets:

- The primary air inlet providing under draught to the base of the fire chamber through the controls on the fire doors of the stove.
- The air wash system (so called because its pre-heated high speed air washes, across the inner face of the door glass, keeping it clear), which provides over draught to the fire chamber.

PRIMARY AIR

On the Valor Hamlet, primary air enters the appliance through the controls on the bottom of either fire doors. Moving the control knobs to the plus symbol (+) will increase the air inlet, moving to the minus symbol (-) to reduce the air inlet, or to close the ash door completely.

AIRWASH SYSTEM

The air wash has an internal sliding plate with slots, housed within a cover plate, and is located above the fire doors. Sliding the control knob to the right towards the plus symbol (+) as far as it will go, achieves the fully open position. Sliding it to the left, minus symbol (-) will shut off the air inlet slots as shown in Fig. 18. and Fig. 19.



Fig. 18. Fully Closed



Fig. 19. Fully Open

MULTI-PURPOSE OPERATING TOOL

Your Valor Hamlet stove comes with a multi-purpose operating tool, which is used for riddling, setting the multifuel grate, (fuel position), adjusting the air inlet holes and for the removal of the ashpan.

SETTING THE GRATE

To use the operating tool for setting the grate in the coal burning position or the wood burning position, place the tool over the external round bar extension, found on the front right hand side of the stove, (see Fig. 20.), move the lever to the desired position as indicated upon the bracket fixed to the stove. This lever is also used for de-ashing and riddling



Fig. 20. Setting The Grate

TO EMPTY THE ASH PAN

Open the fire doors. Fit the fork end of the operating tool into the ash pan and remove from the ash pit chamber.

Empty the ash into a suitable container and replace ashpan into the stove, withdraw the operating tool and close the fire doors. (Also see section on ash removal)

Warning: The ash can be very hot. Empty only into a metal container. Even if the ash appears cold, red-hot pieces of ash may be concealed and could easily start a fire or cause an injury.

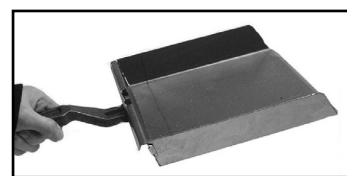

Fig. 21. Operating Tool & Ashpan

DE-ASHING (RIDDLE)

It is necessary to maintain an ash layer on the upper surface of the grate bars, in order to protect them so de-ashing should cease as soon as the first red embers drop into the ash pan. Further de-ashing will cause heat build-up under the grate, which will considerably shorten its life. This operation should be carried out with the doors closed to prevent dust escaping into the room.

- Move up and down vigorously the riddling lever (ash will fall into the ash pan beneath the grate). See Fig. 20.
- When de-ashing is complete re-set grate to previous position.
- Empty the ash pan.

Note: Do not force the riddling lever.

ADJUSTING AIR INLET CONTROLS

The operating tool can also be used to adjust the air inlet control knobs relating to the airwash and the primary air inlets. Use the fork end of the tool, place side onto the knob and push un the desired direction as in Fig. 22 & 23.



Fig. 22. Adjusting Primary Air Inlet



Fig. 23. Adjusting Airwash Controls

MAIN FIRE DOOR HANDLE

A stove mitten is supplied with your Valor Hamlet multifuel stove, this is provided for the operation of the fire door handle whilst the stove is in use. Care must be taken when opening and closing the fire doors as any surrounding areas of the stove will be very hot.

Warning : Never attempt to open the fire doors whilst the appliance is in use, without the use of the stove mitten or suitable gloves, serious injuries may occur.

OPERATING INSTRUCTIONS

OVER-FIRING

Do not over fire your appliance. Using flammable liquids or too much wood or firing the fire at maximum for prolonged periods may result in over-firing. If the chimney connector or casing glows red it is being over-fired. If this occurs immediately close all air inlets to the appliance to reduce the air supply to the fire. Should a chimney fire occur immediately close the appliance down. Get everyone out of the house and call the fire brigade. A chimney fire may cause structural damage of the chimney. Do not use the appliance until the chimney and connector have been inspected and any damaged parts repaired or replaced. This should be done by a competent person such as a HETAS registered engineer.

CLINKER

The formation of clinker suggests that the unit is being over-fired. Any clinker forming on the grate should be removed when cold.

ASH REMOVAL

The ash pan should be emptied at least twice a day or when the level of ash reaches the top of the ash pan. On no account should the ash be allowed to build up to touch the underside of the grate bars as this will greatly shorten their life span.

When the appliance is burning **Wood** only, it is acceptable to maintain an ash bed on top of the grate bars, of approximately 20mm (3/4") without any un-due effect upon the grate bars.

EXTENDED BURNING

The appliance will burn for an extended period provided:

- Sufficient fuel is placed in the firebox.
- The controls are set correctly.
- Excess draught is not present in the chimney.
- Fire door is closed.
- If the fire goes out with unburnt fuel left in the firebox increase the air opening slightly, and vice versa.

In the morning

- Open the air control fully until embers begin to glow brightly and place pieces of fuel on the fire until it is well established.

WARNING: When wood is burnt slowly in a closed appliance it produces moisture and tar, which will create condensation and deposits in the chimney. This effect can be minimised by burning hard for a short period, about 20 minutes, twice a day. It is usually convenient to do this morning and night.

Note: *To avoid chimney problems your fire should not be burnt slowly for longer than 12 hours without a period of fast burning.*

WARNING: *Properly installed, with a suitable flue and chimney correctly operated and maintained this appliance will not emit fumes into the dwelling. Occasional fumes from the de-ashing and re-fuelling may occur. However, persistent fume emission is potentially dangerous and must be investigated by a Hetas registered installer.*







Stop using the appliance if you smell fumes or see smoke escaping.

If fume emission does persist, the following immediate actions should be taken.



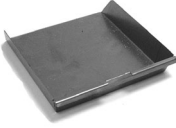

- Open doors and windows to ventilate room.
- Let the fire die or extinguish and safely dispose of fuel from the appliance.
- Check the flue or chimney for a blockage, and clean if required.

Seek expert advice from your HETAS registered installer. Do not attempt to re-light the fire until the cause of the fume emission has been identified and corrected

SPARE PARTS LIST

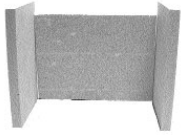
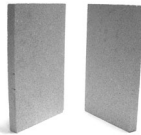
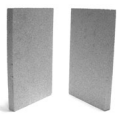
Part Description	Visual Aid (not to scale)	Valor Hamlet Part No.
1. Fuel Retaining Bar		AFS1192
2. Throat Plate		AFS1019
3. Grate Bar		AFS001
4. Hot Plate		AFS010
5. Operating Tool		AFS008
6. Ashpan		AFS058
7. Flue Spigot		AFS009

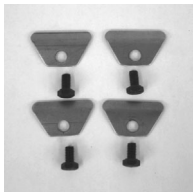
SPARE PARTS LIST

Part Description	Visual Aid (not to scale)	Valor Hamlet Part No.
8. Liner Set		AFS1156
9. Side Liner		AFS1058
10. Back Liner Set		AFS1157
11. Glass Replacement Kit Complete with Gasket		AFS1278
12. Glass Clips		AFS1010
13. Hinge kit Comprises 2 Hinges & 6 screws.		AFS1279
14. Airwash (Curved)		AFS1280

SPARE PARTS LIST

Part Description	Visual Aid (not to scale)	Valor Hamlet Part No.
15. Fire Door Rope Kit Complete with Door Rope Glue.		AFS1021
16. Main Door Assembly Complete with Handle, Glass, Gaskets, Clips and Seal.		L/H AFS1281 R/H AFS1282
17. Replacement Instruction Manual		AFS1283
18. Fire Door Locking Assembly		AFS1284
19. Stove Mitten.		AFS1285
20. Rear Grate Bar Support		AFS1277
21. Comb with Comb Extension		AFS1276

GUARANTEE

Your Valor Hamlet stove carries a guarantee against defects of manufacture and faulty workmanship for a period of one year from the date of purchase. This does not apply to items which would be subject to fair wear or tear. Firebox liner panels, throat plate, door rope, door glass and gaskets are not covered by the guarantee. However, should you have any problems with your appliance please contact your Valor stockist who will have the knowledge and facilities to help you.

Valor will not be responsible for any consequential or incidental loss, damage, or injury however caused.

USE OF SPARE PARTS OTHER THAN THOSE SUPPLIED BY VALOR WILL INVALIDATE THE APPLIANCE WARRANTY.

All Guarantee periods commence on the date of purchase and are non-transferable. Our Guarantee is offered as an addition to your statutory rights.

Guarantee applicable to original purchaser only. Not transferable.

This installation and operating manual gives sufficient details to enable the appliance to be installed and maintained. If further information is required, our **Valor Technical Helpline** will be pleased to help.

Please telephone 08706 061 065 (local rates apply) or by email: **technical@valor.co.uk**

If you are calling from the Republic of Ireland please phone 0044 08706 061 065

When you contact them, they will need to know :

1. Your name, address, post code and telephone number.
2. Date of purchase and supplier details
3. Name of installer
4. Stove serial number
5. Clear and concise details of the fault.

Please complete the following for you own records

Date of Purchase.....Model..... Serial Number.....

Name and address of supplier.....
.....
.....

Name and address of Installer.....
.....
.....

SERVICE RECORD

Date of Visit	Company	Work Carried Out	Signature

Should you have any questions about your Valor Hamlet Multifuel Stove that is not covered in this manual please contact your Valor retailer.

Please keep all repair receipts safely.

Please ensure you have this manual available when an engineer visits as they will complete the service record chart.

FINAL FACTORY CHECK LIST

Model.....
Serial No.....

QUALITY	
FINISH	
PARTS	
FLUE OUTLET	
HOT PLATE	
FUEL RETAINER BARS X2	
GRATE BARS	
FIREBOX LININGS	
THROAT PLATE	
AIR WASH	
DOOR CATCH	
ASH PAN	
OPERATING TOOL	
OPERATING INSTRUCTIONS	
STOVE MITTEN	

*I've checked it
and it's O.K.*

Assembled by.....

Checked by



Baxi Fires Division, Erdington, Birmingham, B24 9QP