

OWNER GUIDE

Valor Sirius

MODEL BR643 VA

Valor Quantum

MODEL BR644 VA

(GC No. 32-032-34)



**INSET LIVE FUEL
EFFECT GAS FIRE**

**THIS APPLIANCE IS FOR USE WITH NATURAL GAS (G20).
WHEN CONVERTED USING CONVERSION KIT NO. 0591149 THIS
APPLIANCE IS FOR USE WITH PROPANE GAS (G31).
THIS APPLIANCE IS FOR USE IN THE UNITED KINGDOM (GB) AND THE
REPUBLIC OF IRELAND (IE) ONLY.**

We trust that these instructions give sufficient details to enable this appliance to be installed and maintained satisfactorily. However, if further information is required, our

Valor Technical Helpline will be pleased to help.

Telephone **08706 061 065** (National call rates apply in the United Kingdom)

INSTALLER: Please leave this guide with the owner

OWNER GUIDE

CUSTOMER CARE

Thank you for choosing Valor.

All Valor gas fires are designed to meet the most stringent quality, performance and safety requirements to provide our customers with many years' trouble-free service. Your owner guide aims to improve your understanding and appreciation of your Valor gas appliance by providing simple and informative instructions to ensure that you benefit from the excellent performance and features it has to offer.

If you require further assistance or any advice about gas in general, our **Technical Helpline** will be pleased to help.

Please telephone **08706 061 065** (National call rates apply in the United Kingdom).
In the Republic of Ireland please telephone **0044 08706 061 065**

LIST OF CONTENTS

SAFETY.....	3
OPERATING YOUR FIRE.....	4
CLEANING.....	6
REFITTING CERAMICS.....	7
MAINTENANCE.....	13

OWNER GUIDE

SAFETY

IF YOU SMELL GAS

DON'T SMOKE

EXTINGUISH ALL NAKED FLAMES

DON'T TURN ELECTRICAL SWITCHES ON OR OFF

TURN OFF THE GAS SUPPLY AT THE METER

OPEN DOORS AND WINDOWS TO GET RID OF THE GAS

IMMEDIATELY CALL THE GAS EMERGENCY SERVICE – SEE YOUR LOCAL TELEPHONE DIRECTORY

DO

- Have the fire installed by a competent person. In the United Kingdom, installation must be in accordance with the latest edition of the Gas Safety (installation & use) Regulations. In the Republic of Ireland, installation must be in accordance with all national and local regulations in force.
- Have the chimney swept prior to installation if it was previously used for solid fuel.
- Have the fire installed in accordance with the installation instructions
- Provide a minimum clearance of 750mm from the top surface of the hearth to any shelf made of wood or other combustible material where the shelf is not more than 150mm deep. For a shelf deeper than 150mm, add 12.5mm to the clearance for every 25mm of additional shelf depth.
- Always use a fireguard complying with BS 8423 for the protection of young children, the elderly or infirm.
- Wait three minutes before attempting to relight if the fire is switched off or the flames are extinguished for any reason.
- Get advice about the suitability of any wall covering near your fire. Soft wall coverings (e.g. embossed vinyl, etc.) which have a raised pattern are easily affected by heat. They may, therefore, scorch or become discoloured when close to a heating appliance. Please bear this in mind whenever you are considering redecorating.
- Provide a minimum clearance of 100mm from the outside of the fire case to any corner wall or other surface. Please bear this in mind if ever you are altering the room.

DON'T

- Hang clothing, towels or any other fabrics over the fire.
- Throw paper or other materials onto your fire.
- Use the fire with damaged base ceramics.
- Put more loose coals / pebbles on the fire than the number given in this guide or use any coals / pebbles other than those authorised for this fire. Incorrect combustion could result.
- Attempt to clean or service the fire until it has been switched off and allowed to cool.

OWNER GUIDE

OPERATING YOUR FIRE

PLEASE NOTE

When operating your fire for the first time, some vapours may be given off which may cause a slight odour and could possibly set off any smoke alarms in the immediate vicinity. These vapours are quite normal with new appliances. They are totally harmless and will disappear after a few hours use.

The Oxysafe flame sensing & flue blockage safety system.

For your safety, this appliance is fitted with a flue blockage safety device which will shut down the appliance in the event of abnormal flue conditions. ***This device is NOT a substitute for an independently mounted Carbon Monoxide detector.***

The device will also automatically shut off the gas supply to the fire if the pilot flame goes out due to lack of oxygen or for any other reason.

If this device starts to repeatedly shut off the gas, get expert advice.

This device incorporates a probe which senses that the heat from the pilot flame is correct. If this probe is cool, the device will prevent any gas flow unless the control knob is kept depressed at the “Pilot/Ign” position.

If, for any reason, the flames go out when the fire is hot or if the fire is turned off when hot, always ***wait at least three minutes before attempting to relight.***

Lighting the pilot

This fire is controlled by a 4-position gas tap mounted on the front leg of the appliance. In addition to the “Off” position there is a pilot light and 2 heat control settings. See figure 1.

- Depress the control knob and turn anticlockwise towards the “**Pilot/Ign**” position. A spark should be generated at the pilot while turning. The spark should ignite the pilot. The pilot flame can be seen below the coal / pebble at the front left side.
- Keep the button at the “**Pilot/Ign**” position for a further ten seconds. This will prevent the flame-sensing device from shutting off the gas while its probe warms up.
- If the pilot does not ignite instantly, repeat procedure. **If after 10 seconds pilot ignition has not occurred, turn the control knob back to the “Off” position, wait for 3 minutes and then repeat the ignition procedure.**

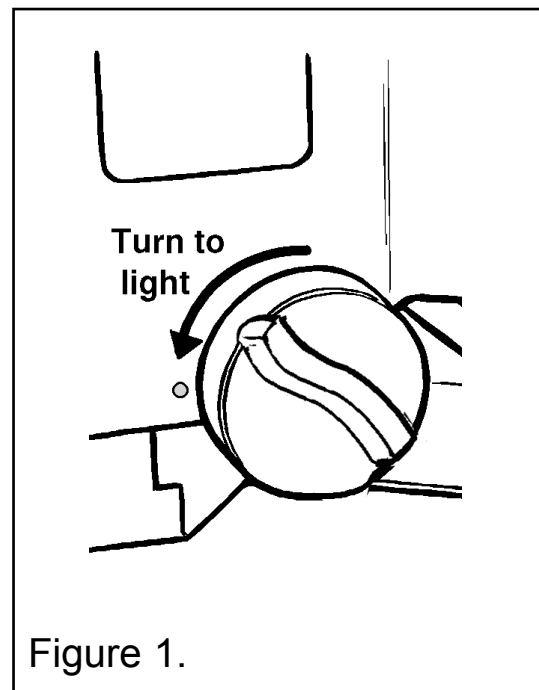

Figure 1.

OWNER GUIDE

Lighting the Main Burner

- Once the pilot light is established, the main burner can be lit by depressing and turning the control knob anticlockwise to the “**High**” position.

Selecting the Heat Setting

- In order to change from one setting to another depress the control knob slightly and turn the knob to the required position. Any setting from “**Low**” to “**High**” may be selected.

***Note:** The appliance will operate to its maximum potential if the flue is primed during the first 20-30 minutes of operation. To do this, simply operate the appliance at its “High” setting. This will also burn off any carbon deposits that may have formed during previous operations. If operating the appliance for long periods it is beneficial to change between settings. This will help to remove any carbon deposits that may form during operation.*

Turning the fire back to Pilot Setting

- Depress the control knob and turn clockwise until the pilot setting is reached.

Turning the Appliance Off

- Make sure that the control knob is in the pilot position. Depress the control knob and turn clockwise to the “**Off**” position.
- **Wait at least three minutes before relighting.**

OWNER GUIDE

CLEANING

To maintain the high performance and quality finish of your Valor appliance, please follow these guidelines:

- Before attempting to clean the fire, please remember to turn off the fire and wait for the appliance to cool. The fire will retain heat for some time before cleaning can begin.
- If any pieces of debris are found in the firebox, have the chimney inspected before further use.

Metal Parts

- Clean the metal parts with a slightly damp cloth and then dry.
- Do not use abrasive cleaners as these will scratch the fire surface.

Ceramic fuel effect and Rear Wall

- Light coatings of soot will usually be burnt off during the normal operation of the fire.
- Should any soot accumulation become excessive, the fuel effect pieces and walls should be removed from the fire for cleaning.
- This product uses fuel effect pieces, burner compartment walls and gaskets containing Refractory Ceramic Fibres (RCF), which are man-made vitreous silicate fibres. Excessive exposure to these materials may cause irritation to eyes, skin and respiratory tract. Consequently, it is important to take care when handling these articles to ensure that the release of dust is kept to a minimum. To ensure that the release of fibres from these RCF articles is kept to a minimum, during installation and servicing we recommend that you use a HEPA filtered vacuum to remove any dust and soot accumulated in and around the fire before and after working on the fire. When replacing these articles we recommend that the replaced items are not broken up, but are sealed within a heavy duty polythene bag, clearly labelled as RCF waste. This is not classified as “hazardous waste” and may be disposed of at a tipping site licensed for the disposal of industrial waste. Protective clothing is not required when handling these articles, but we recommend you follow the normal hygiene rules of not smoking, eating or drinking in the work area and always wash your hands before eating or drinking.

Cleaning should be carried out in a well ventilated area or in the open air by gently brushing with the pieces held away from your face so that you avoid inhaling the dust.

- We suggest that you remove the coals / pebbles in the reverse order to that shown in the fuel bed refitting instructions.

Burner

- The burner surface can be carefully cleaned to remove any loose particles after taking off the coals / pebbles. Make sure that no particles are pushed into the burner slots.

***Note:** Surface cracking of the burner is normal and no cause for concern.*

OWNER GUIDE

REFITTING CERAMICS

Both models

1. Fit the burner tray trim over the front rim of the burner tray. Push the trim fully down. See figure 2.

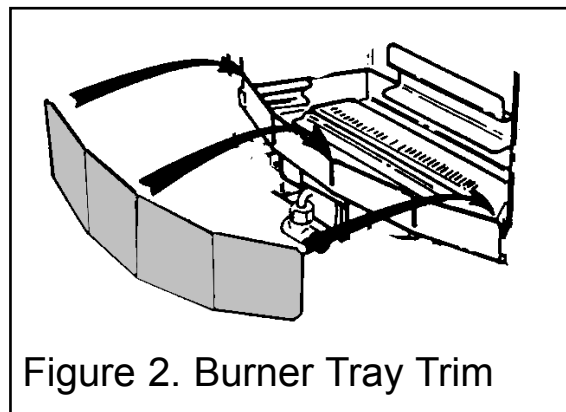

Figure 2. Burner Tray Trim

Fitting Coals to models supplied with a Coal Ceramic Fuel Effect.

(For models supplied with a Pebble Ceramic fuel effect see section headed 'Fitting Pebbles to models supplied with Pebble Ceramic Fuel Effect').

1. Place the rear base coal in the firebox. It should rest on the ledges at the sides and back of the firebox and its rear face should touch the rear ceramic wall. See figure 3.

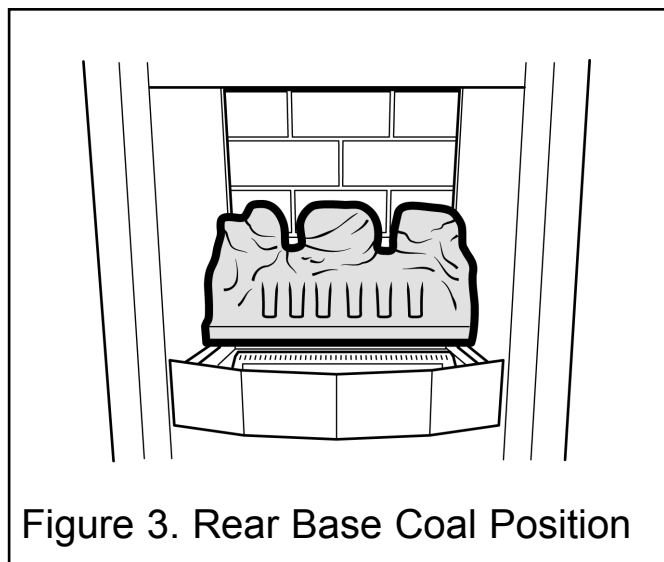

Figure 3. Rear Base Coal Position

OWNER GUIDE

2. Place the front base coal in the firebox with its bottom front locating over the front rim of the firebox. Pull the coal forward so that it locates immediately behind the front rim of the firebox. See figure 4.

There are two types of loose coals. These are identified with the letter “A” or “B” on the underside of the coal.

There are three “A” coals and two “B” coals.

3. Place a type “A” coal between the front and rear base coals with the letter “A” upright and so that the coal is against the left side of the firebox. See figure 5.

4. Place a type “B” coal between the front and rear base coals as shown in figure 6. The letter “B” should be upright.

5. Place a type “A” coal between the front and rear base coals with the letter “A” upright. The top of the coal should rest against the centre coal of the rear base coal as shown in figure 7.

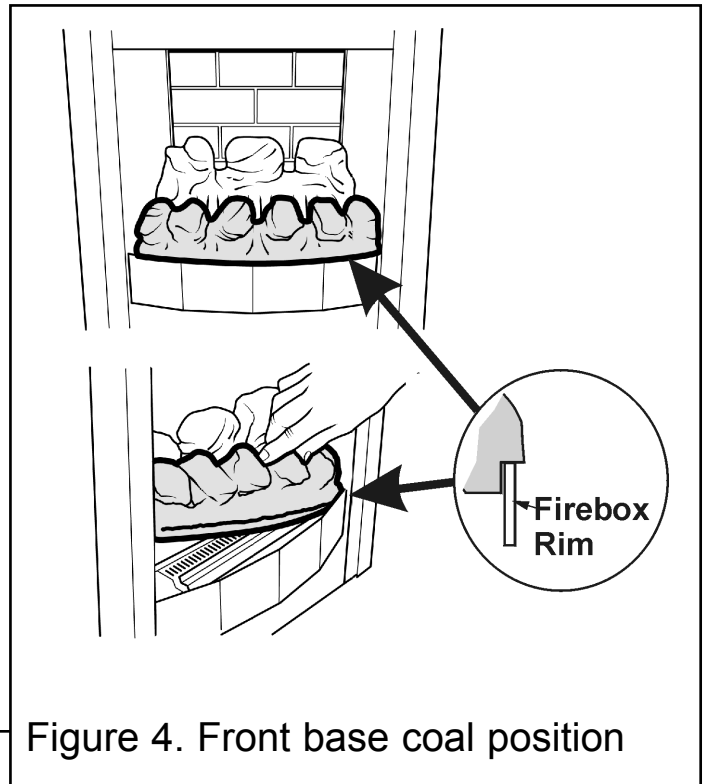

Figure 4. Front base coal position

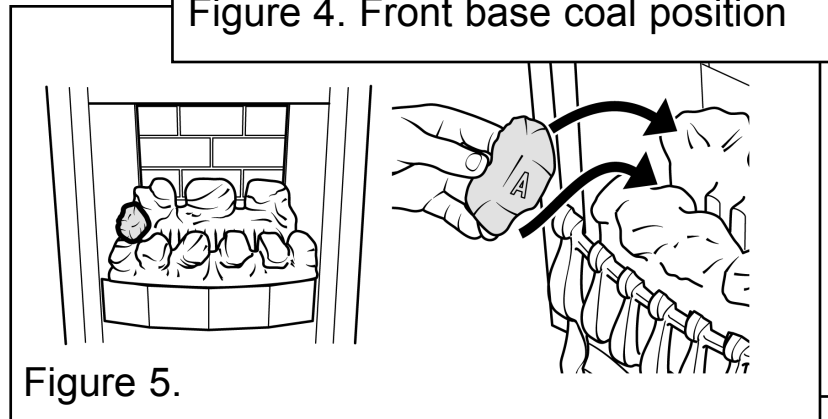

Figure 5.

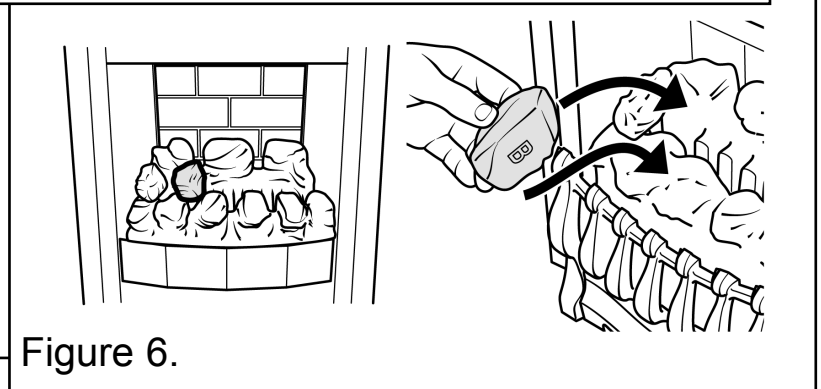

Figure 6.

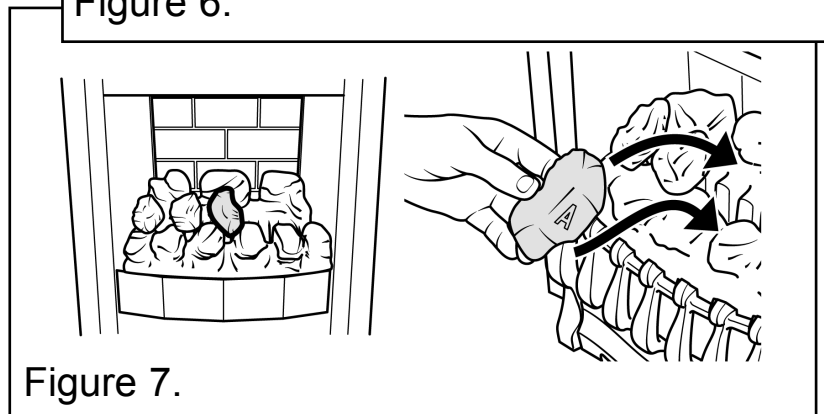

Figure 7.

OWNER GUIDE

6. Place the remaining type “B” coal at the right side of the firebox between the front and rear base coals. The letter “B” should be upright. The coal should touch the right side of the firebox. See figure 8.



Figure 8.

7. Place the remaining type “A” coal between the front and rear base coals. The letter “A” should be upside down with its rear face between the right and centre coals of the rear base coal. Angle the coal so that the gap between it and the type “B” coal to its right is appreciably larger than the gap between it and the type “A” coal to its left but do not have it touching the type “A” coal. This will give the best flame effect. See figure 9.

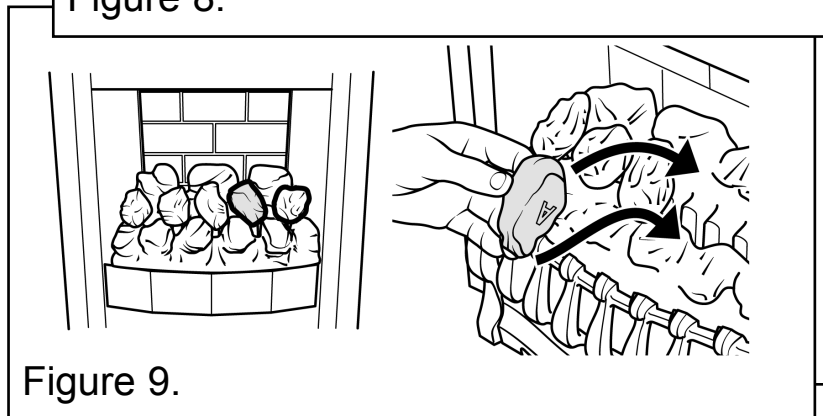

Figure 9.

Fitting Pebbles to models supplied with Pebble Ceramic Fuel Effect.

(For models supplied with a Coal Fuel Effect see section headed ‘Fitting Coals to models supplied with a Coal Ceramic Fuel Effect’).

1. Place the rear base pebble in the firebox. It should rest on the ledges at the sides and back of the firebox and its rear face should touch the rear ceramic wall. See figure 10.

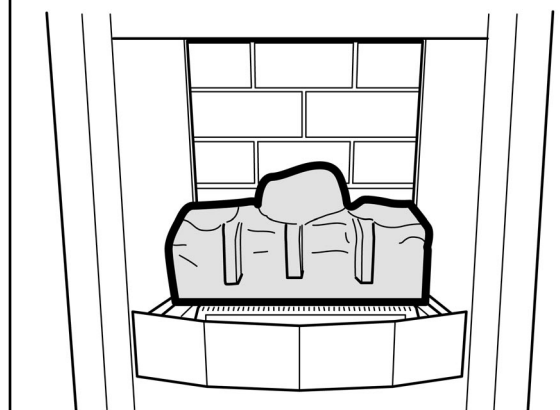

Figure 10 Rear Base Pebble Position

2. Place the front base pebble in the firebox with its bottom front locating over the front rim of the firebox. Pull the pebble forward so that it locates immediately behind the front rim of the firebox. See figure 11.

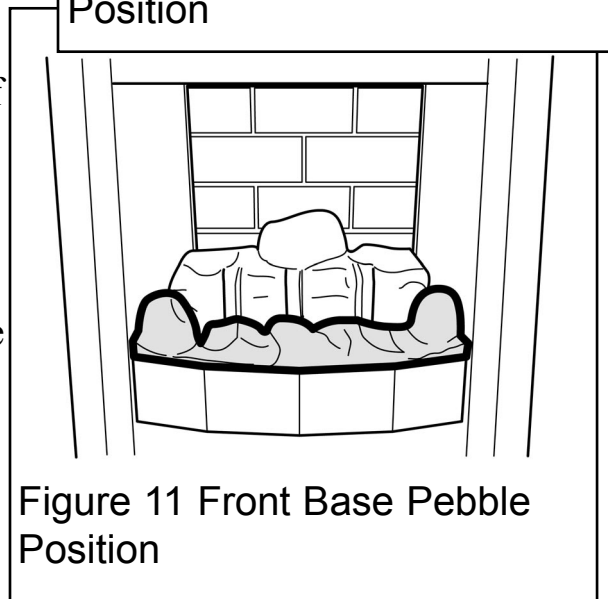

Figure 11 Front Base Pebble Position

OWNER GUIDE

Install the 11 loose pebbles as follows. The underside of each pebble is marked with a letter 'A' to 'K' and an arrow.

The pebbles should be positioned so that the arrows always point towards the back of the fireplace opening. When located into position the stem of each arrow should be at 90° to the rear of the fireplace opening (See figure 12).

3. Hold pebble 'A' upright with the arrow pointing to the top. Place pebble "A" on top of the front base pebble. The pebble should rest against the moulded pebble to its left. (See figure 12).

4. Hold pebble 'B' upright with the arrow pointing to the top. Place pebble "B" on top of the front base pebble. (See figure 13).

5. Hold pebble 'C' upright with the arrow pointing to the top. Place pebble "C" on top of the front base pebble. It should lie against the moulded pebble to its left. (See figure 14).

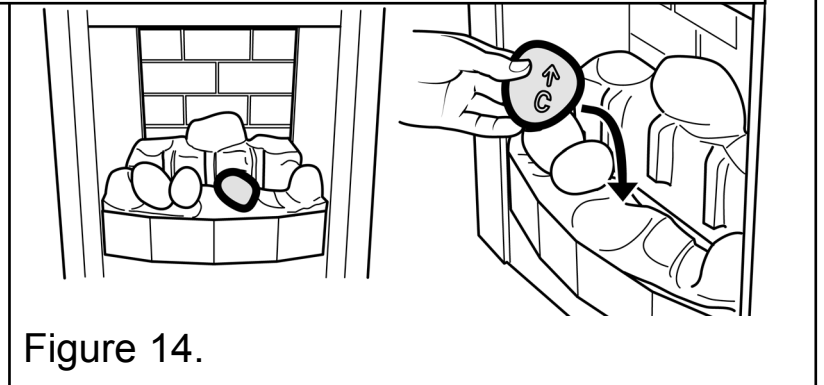
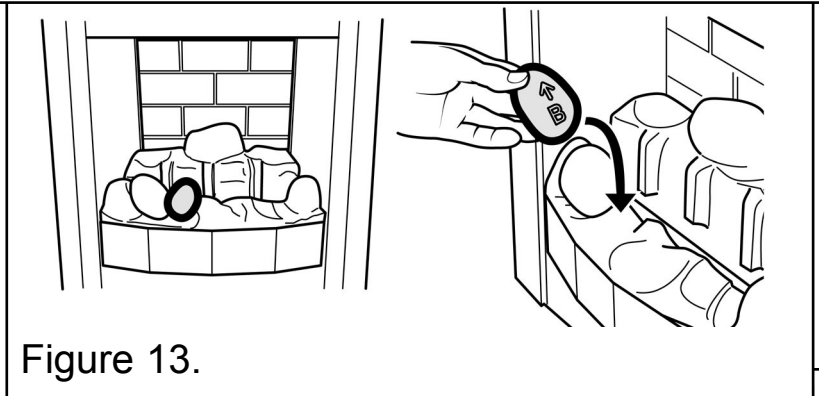
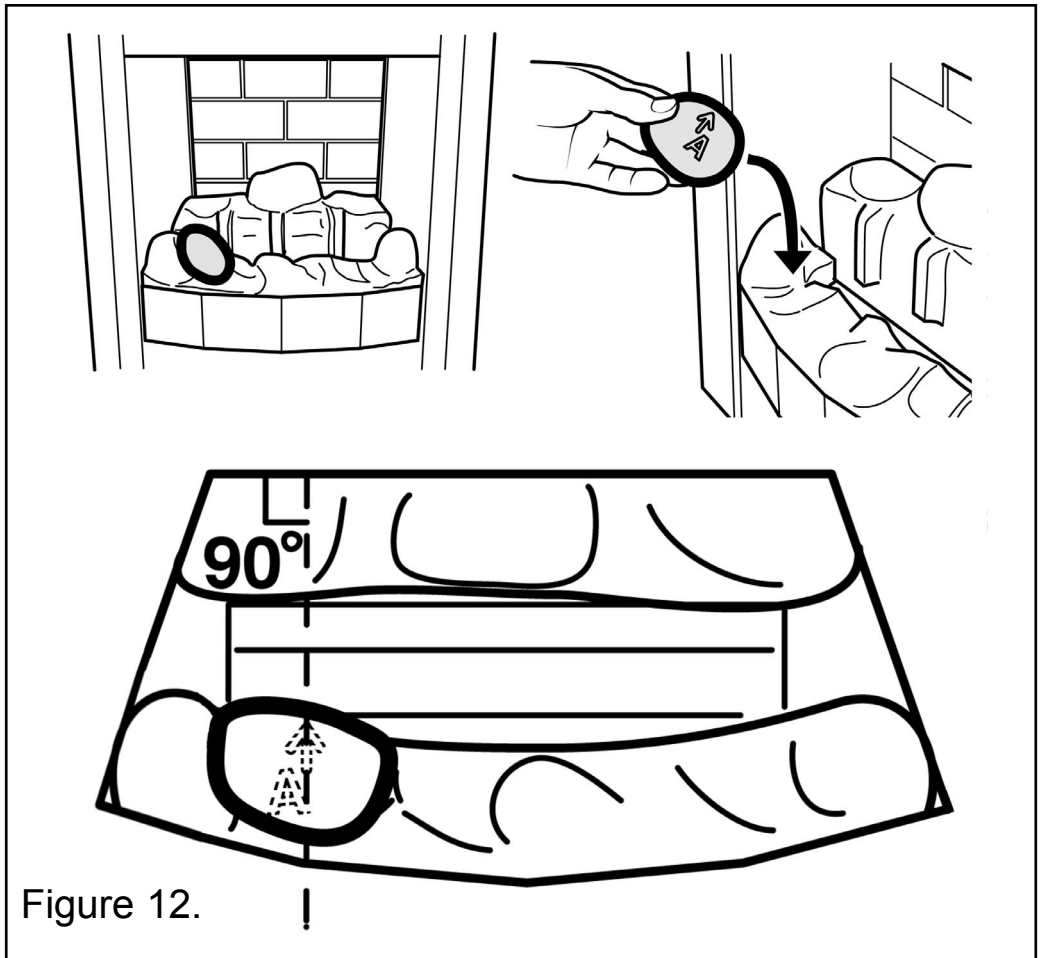

OWNER GUIDE

6. Hold pebble 'D' upright with the arrow pointing to the top. Place pebble "D" on top of the base front pebble. It should rest against the moulded pebble to its right. (See figure 15).

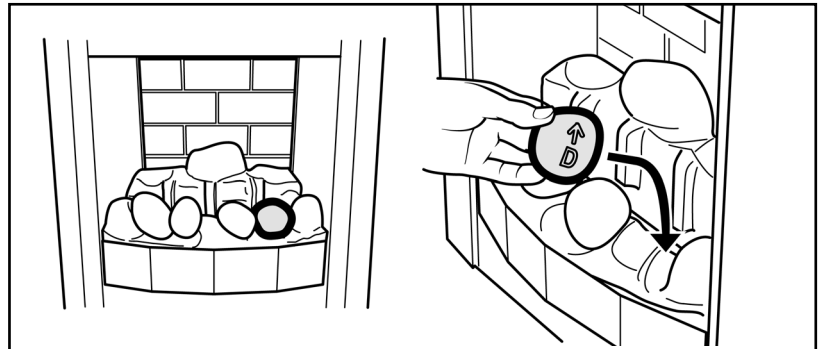

Figure 15.

7. Hold pebble 'E' upright with the arrow pointing to the top. Place pebble 'E' between the front and rear base pebbles. It should rest against the side of the firebox. (See figure 16).

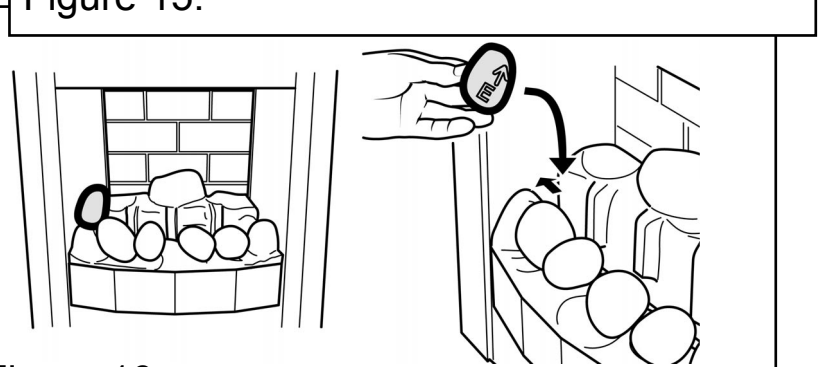

Figure 16.

8. Hold pebble 'F' upright with the arrow pointing to the top. Place pebble 'F' between the front and rear base pebbles. It should rest on top of pebble 'A' & 'B'. (See figure 17).



Figure 17.

9. Hold pebble 'G' upright with the arrow pointing to the top. Place pebble 'G' between the front and rear base pebbles. It should rest on top of pebble 'B' & 'C' and rest against the moulded pebble in the rear pebble base. (See figure 18).

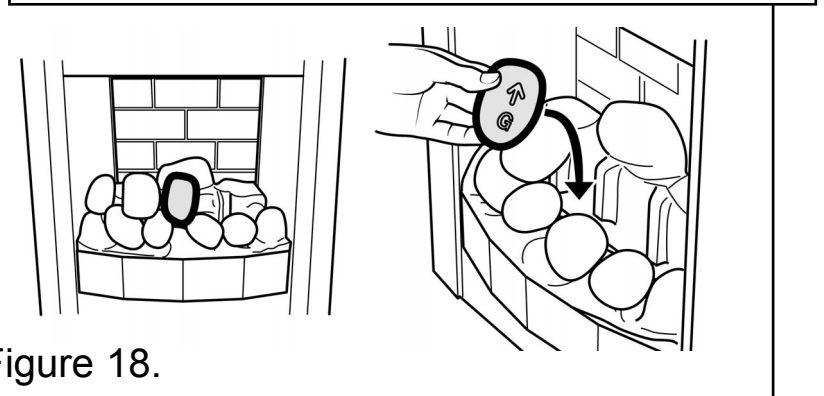
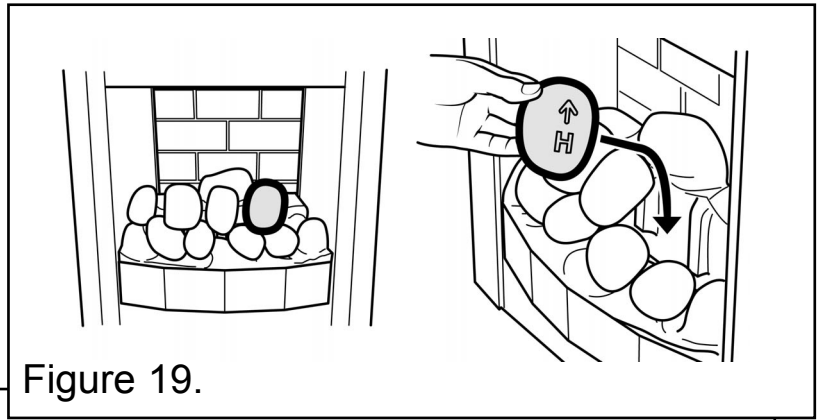

Figure 18.

OWNER GUIDE

10. Hold pebble 'H' upright with the arrow pointing to the top. Place pebble 'H' between the front and rear base pebbles. It should rest in between pebbles 'C' & 'D' and against the moulded pebble in the rear pebble base. (See figure 19).



11. Hold pebble 'I' upright with the arrow pointing to the top. Place pebble 'I' between the front and rear base pebbles. It should rest against the side of the firebox (See figure 20).

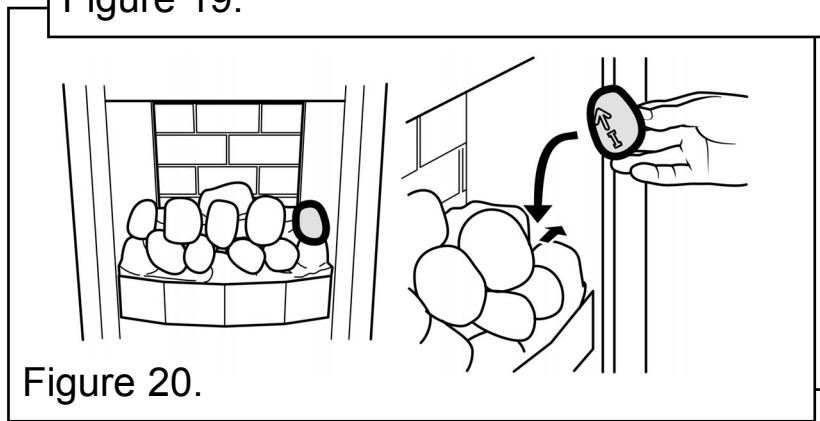

12. Hold pebble 'J' upright with the arrow pointing to the top. Place pebble 'J' on top of the base pebble rear. (See figure 21)

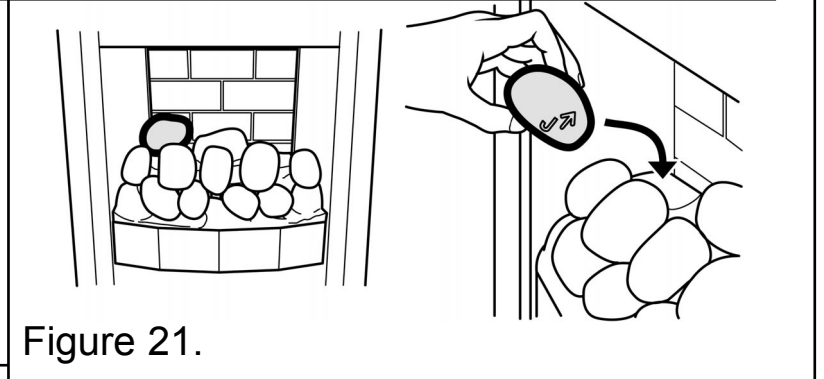

13. Hold pebble 'K' upright with the arrow pointing to the top. Place pebble 'K' on top of the base pebble rear. (See figure 22)

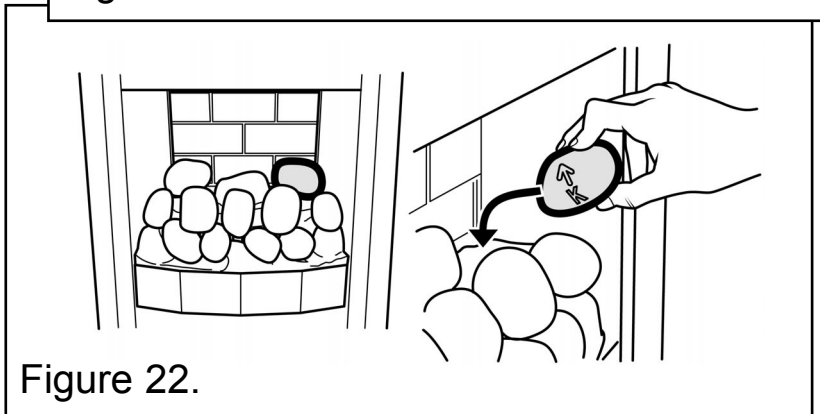

OWNER GUIDE

MAINTENANCE

Regular maintenance

In order to achieve and maintain high levels of personal safety and performance efficiency, it is essential that the opening at the back of the fire and the flue are kept clear of any form of obstruction. It is possible that deposits of mortar or soot could fall and accumulate causing the flue to be blocked or restricted and so preventing proper clearance of dangerous exhaust fumes.

In the United Kingdom it is the law that a landlord must have any gas appliance, flue and pipework which is situated in a tenant's premises checked for safety at least every twelve months by a competent person (In the U.K, a CORGI registered installer).

We recommend that all gas appliances and their flues, wherever situated, are checked annually.

Servicing

- In the United Kingdom servicing can be carried out either by a Valor service engineer or a CORGI registered installer.
- If you require your fire to be serviced, please contact **Valor Service** on **08706 090 081** and quote the following details;
model name and number.
appliance serial no. (To be found on the plate close to the control knob.)
- If you wish to replace any of the owner replaceable parts listed below, please contact **Valor Spares** on **08706 000 454** for your nearest stockist of these parts. When ordering please quote the part number shown below.

Owner Replaceable Parts

<u>Description</u>	<u>Part No</u>
Ceramic rear wall (Sirius)	0579409
Ceramic rear wall (Quantum)	0579399

Coal model

Front coal	0579119
Rear base coal	0579129
Pack of loose coals	0579149

Pebble model

Front pebble	3002771
Rear base Pebble	3002772
Pack of loose Pebbles	3002773

OWNER GUIDE

- **When fitting replacement parts, follow the instructions contained in this guide. It is important that only Valor approved parts are used for maximum safety.**
- In the United Kingdom, for general advice about gas and your gas fire call our **Technical Helpline 08706 061 065.**
- In the Republic of Ireland call **0044 08706 061 065** for all enquiries.