



OWNER'S GUIDE

MODEL BR419 VA

(G.C.32-032-08)

Inset Live Fuel Effect

Gas Fire

with

Ultimate Fireslide

or

Colourway

Front



**AS SUPPLIED, THIS APPLIANCE IS FOR USE WITH NATURAL GAS (G20)
WHEN CONVERTED USING VALOR CONVERSION KIT NO.0591149 THIS
APPLIANCE IS FOR USE WITH PROPANE GAS (G31)
THIS APPLIANCE IS FOR USE IN THE UNITED KINGDOM (GB) AND THE
REPUBLIC OF IRELAND (IE) ONLY.**

This guide is intended to help you care for your Valor gas fire. Please read thoroughly before using and keep for future reference

We trust that this guide gives sufficient details to enable your appliance to be operated and maintained satisfactorily. However, if further information is required, our **Valor Technical Helpline** will be pleased to help.
Please telephone **08706 061 065** (National call rates apply).

This guide to be left with the owner

OWNER'S GUIDE

Safety First.

Valor fires are CE Approved and designed to meet the appropriate British Standards and Safety Marks.



Quality and Excellence at the heart of every Valor fire.

All Valor fires are manufactured to the highest standards of quality and excellence and are manufactured under a BS EN ISO 9001 quality system accepted by the British Standards Institute.



The Highest Standards

Valor is a member of the Society of British Gas Industries which works to ensure high standards of safety, quality and performance.



Careful Installation

Valor is a CORGI registered company. All our gas fires must be installed by a competent CORGI Registered Installer in accordance with our Installer Guide and should not be fitted directly on to a carpet or floor of combustible material.



Valor Heating, Erdington, Birmingham B24 9QP
www.valor.co.uk

Because our policy is one of constant development and improvement, details may vary slightly from those given in this publication

OWNER'S GUIDE

LIST OF CONTENTS

SAFETY	4
APPLIANCE DIMENSIONS	6
OPERATING YOUR FIRE	7
The Oxysafe flame sensing & flue blockage safety system.	7
To light the fire.....	7
To turn the fire off.....	8
Lighting with a taper	8
CLEANING	9
Metal Parts.....	9
Ceramic Coals and Rear Wall	9
Ceramic burner	10
REFITTING COALS	10
MAINTENANCE	12
Regular maintenance	12
Servicing.....	12
Owner Replaceable Parts	12

C U S T O M E R C A R E

Thank you for choosing Valor.

All Valor gas fires are designed to meet the most stringent quality, performance and safety requirements to provide our customers with many years' trouble-free service.

Your owner guide aims to improve your understanding and appreciation of your Valor gas fire by providing simple and informative instructions to ensure that you benefit from the excellent performance and features it has to offer.

If you require further assistance or any advice about gas in general, the **Valor Technical Helpline** will be pleased to help.

Please telephone **08706 061 065** (National call rates apply in the United Kingdom).

OWNER'S GUIDE

SAFETY

IF YOU SMELL GAS

DON'T SMOKE

EXTINGUISH ALL NAKED FLAMES

DON'T TURN ELECTRICAL SWITCHES ON OR OFF

TURN OFF THE GAS SUPPLY AT THE METER

OPEN DOORS AND WINDOWS TO GET RID OF THE GAS

IMMEDIATELY CALL THE GAS EMERGENCY SERVICE – SEE YOUR LOCAL TELEPHONE DIRECTORY

DO

- ✓ Have the fire installed by a competent person. In the United Kingdom, installation must be in accordance with the latest edition of the Gas Safety (installation & use) Regulations. In the Republic of Ireland, installation must be in accordance with all national and local regulations in force.
- ✓ Have the chimney swept prior to installation if it was previously used for solid fuel
- ✓ Have the fire installed in accordance with the installation instructions
- ✓ Provide a minimum clearance of 750mm from the top surface of the hearth to any shelf made of wood or other combustible material where the shelf is not more than 150mm deep. For a shelf deeper than 150mm, add 12.5mm to the clearance for every 25mm of additional shelf depth.
- ✓ Provide a suitable guard that complies with BS 6539 or 6778 for the protection of young children, the elderly and the infirm. Such a guard is also recommended for the protection of pet animals. *Although this fire conforms to all the applicable standards, it is a heating appliance and certain parts of its surface will become hot.*
- ✓ Wait three minutes before attempting to relight if the fire is switched off or the flames are extinguished for any reason. *Your fire is fitted with a safety device that will automatically shut off the gas supply to the fire if, for any reason, the flames go out.*
- ✓ Get advice about the suitability of any wall covering near your fire. Soft wall coverings (e.g. embossed vinyl, etc.) which have a raised pattern are easily affected by heat. They may, therefore, scorch or become discoloured when close to a heating appliance. Please bear this in mind whenever you are considering redecorating.
- ✓ Provide at least the minimum clearance shown in figure 1 between the outer case sides and any corner wall or other surface that projects beyond the front of the fire. Please bear this in mind if ever you are considering altering the room.

OWNER'S GUIDE

DON'T

- ✘ Hang clothing, towels or any other fabrics over the fire.
- ✘ Add any extra coals above the number stated in this guide. This could cause a safety hazard.
- ✘ Put paper or any other material on the fire.
- ✘ Place any combustible material (rugs, carpet, plastic tiles, etc.) on the hearth.
- ✘ Attempt to clean or service the fire until it has been switched off and allowed to cool completely.

OWNER'S GUIDE

APPLIANCE DIMENSIONS

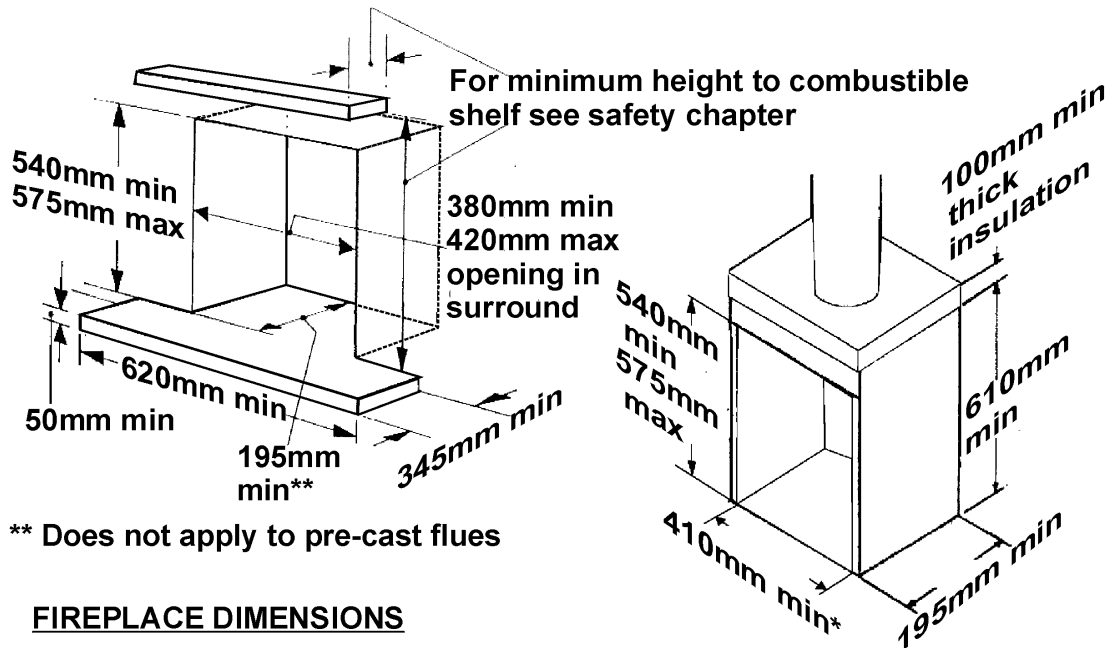

** Does not apply to pre-cast flues

FIREPLACE DIMENSIONS

*If internal width is greater than 440mm, the opening width must be reduced to not more than 440mm to ensure adequate sealing to the fire

TWIN WALLED METAL FLUE BOX (INTERNAL DIMENSIONS)

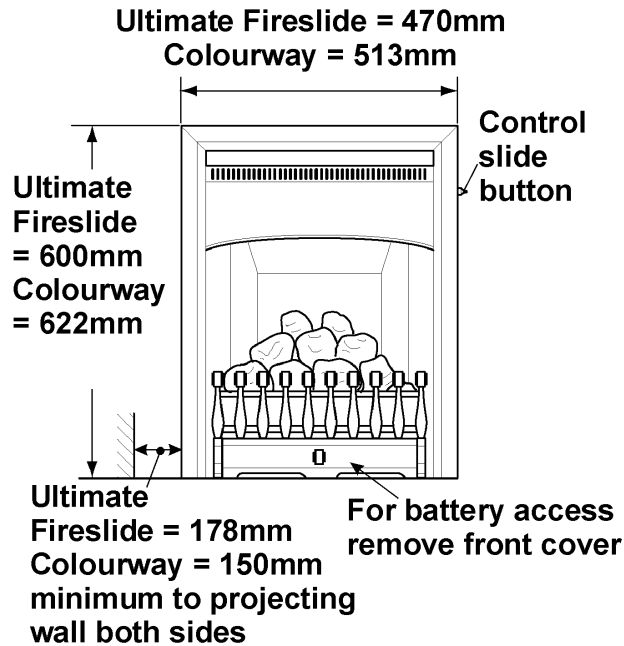

ULTIMATE FIRESLIDE & COLOURWAY

Figure 1. Dimensions & clearances

OWNER'S GUIDE

OPERATING YOUR FIRE

PLEASE NOTE

When operating your fire for the first time, some vapours may be given off which may cause a slight odour and could possibly set off any smoke alarms in the immediate vicinity. These vapours are quite normal with new appliances. They are totally harmless and will disappear after a few hours use.

The Oxysafe flame sensing & flue blockage safety system.

For your safety, this appliance is fitted with a flue blockage safety device that will shut down the appliance in the event of abnormal flue conditions. ***This device is NOT a substitute for an independently mounted Carbon Monoxide detector.***

The device will also automatically shut off the gas supply to the fire if the pilot flame goes out due to lack of oxygen or for any other reason.

If this device starts to repeatedly shut off the gas, get expert advice.

This device incorporates a probe that senses that the heat from the pilot flame is correct. If this probe is cool, the device will prevent any gas flow unless the control knob is held in at the ignition position.

If, for any reason, the flames go out when the fire is hot or if the fire is turned off when hot, always ***wait at least three minutes before attempting to relight.***

To light the fire

The **FireSlide** control is shown in figure 2.

- ▶ Slide the control button to the bottom (ignition) position marked ↓.

In this position, the electronic ignition system should cause a series of sparks that should light the pilot. Within four seconds of the pilot igniting, the main burner should light at its minimum setting.

If no sparks are produced to light the pilot, the battery may need replacing. Details of battery replacement are given further on in this manual. Until you can obtain a replacement battery the fire can be lit with a taper as described later in the instructions.

- ▶ Keep the button at the ignition position for a further ten seconds. This will prevent the flame sensing device from shutting off the gas while its probe warms up as explained above.

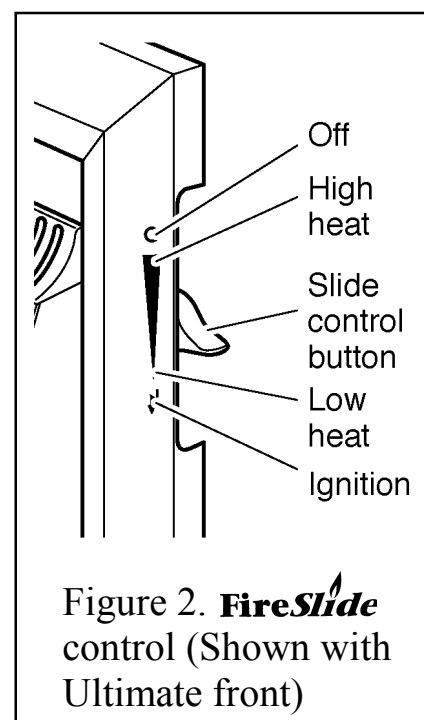

Figure 2. **FireSlide** control (Shown with Ultimate front)

OWNER'S GUIDE

- ▶ If low heat is required, release the button. The button will automatically spring up to the low heat position shown in figure 2 (See note i).
- ▶ For a higher heat level slide the button upwards. The burner flames and heat output will gradually increase until the button reaches the high heat position shown in figure 2. When the button reaches the high heat position you will feel a check to its movement. **Do not slide the button above the high heat position unless you want to turn the fire off** (See note i).

Note

- i. If the flames go out while setting the control, repeat the full lighting procedure. If the flames repeatedly go out have the fire serviced.
- ii. When first turned on the flames will appear predominantly blue. The coals will take time to warm up. Although some glow will be seen after approximately ten minutes, the full visual effect will only be apparent after a somewhat longer time.
- iii. The appliance will operate to its maximum potential if the flue is primed during the first 20 – 30 minutes of operation. To do this, simply slide the control to its highest setting. This will also burn off any carbon deposits that may have formed during previous operations.
- iv. If operating the appliance for long periods it is beneficial to change between settings. This will also help to remove any carbon deposits that may form during operation.

To turn the fire off

Slide the button up past the high heat position to the “O” position until the flames extinguish. Both the main burner and the pilot should go out.

While cooling, the coals may make some crackling noises. This is quite normal.

Lighting with a taper

See figure 3.

In the unlikely event of failure of the ignition spark, the pilot can be lit by a taper or long spill. Insert the taper or spill alongside of the left side of the firebox and operating the slide control as described above.

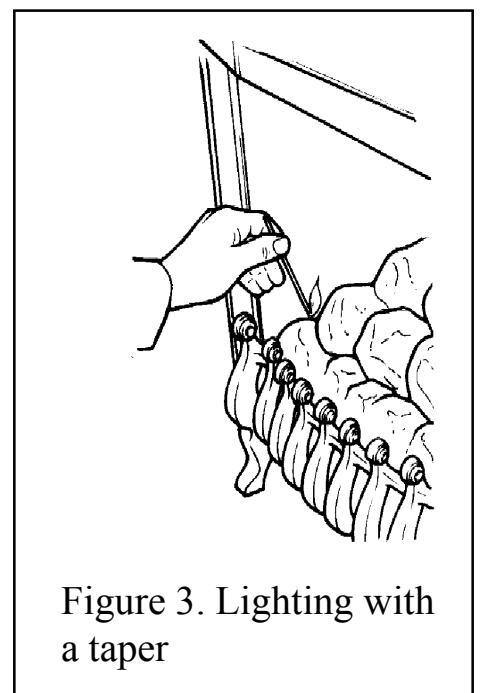

Figure 3. Lighting with a taper

OWNER'S GUIDE

CLEANING

To maintain the high performance and quality finish of your Valor fire please follow these guidelines:

- Before attempting to clean the fire, please remember to turn off the fire and wait for the appliance to cool. The fire will retain heat for some time before cleaning can begin.
- If any pieces of debris are found in the firebox, have the chimney inspected before further use.

Metal Parts

- Clean the metal parts with a slightly damp cloth and then dry.
- Do not use abrasive cleaners as these will scratch the fire surface.

Ceramic Coals and Rear Wall

- Light coatings of soot will usually be burnt off during the normal operation of the fire.
- Should any soot accumulation become excessive, the fuel effect pieces and rear wall should be removed from the fire for cleaning.
- This product uses fuel effect pieces, burner compartment rear wall and gaskets containing Refractory Ceramic Fibres (RCF), which are man-made vitreous silicate fibres. Excessive exposure to these materials may cause irritation to eyes, skin and respiratory tract. Consequently, it is important to take care when handling these articles to ensure that the release of dust is kept to a minimum. To ensure that the release of fibres from these RCF articles is kept to a minimum, during installation and servicing we recommend that you use a HEPA filtered vacuum to remove any dust and soot accumulated in and around the fire before and after working on the fire. When replacing these articles we recommend that the replaced items are not broken up, but are sealed within a heavy duty polythene bag, clearly labelled as RCF waste. This is not classified as “hazardous waste” and may be disposed of at a tipping site licensed for the disposal of industrial waste. Protective clothing is not required when handling these articles, but we recommend you follow the normal hygiene rules of not smoking, eating or drinking in the work area and always wash your hands before eating or drinking.
- This appliance does not contain any component manufactured from asbestos or asbestos related products.
- Cleaning should be carried out in a well ventilated area or in the open air by gently brushing with the pieces held away from your face so that you avoid inhaling the dust.
- We suggest that you remove the coals in the reverse order to that shown in the fuel bed refitting instructions.

OWNER'S GUIDE

Ceramic burner

Remove any deposits of soot or other foreign matter from the solid areas of the burner with a dry soft brush. Be careful not to brush any particles into the open slots. Remove any particles from the slots with a vacuum cleaner fitted with a soft brush attachment. **Do not poke wire, etc. into the slots in the burner.**

REFITTING COALS

1. Fit the ceramic rear wall into the bracket at the back of the firebox. See figure 4.

2. Place the rear base coal in the firebox. It should rest on the ledges at the sides and back of the firebox and its rear face should touch the rear ceramic wall. See figure 5.

3. Place the front base coal in the firebox with its bottom front locating over the front rim of the firebox. Pull the coal forward so that it locates immediately behind the front rim of the firebox. See figure 6.

4. There are two types of loose coals. These are identified with the letter "A" or "B" on the underside of the coal.

There are three "A" coals and two "B" coals.

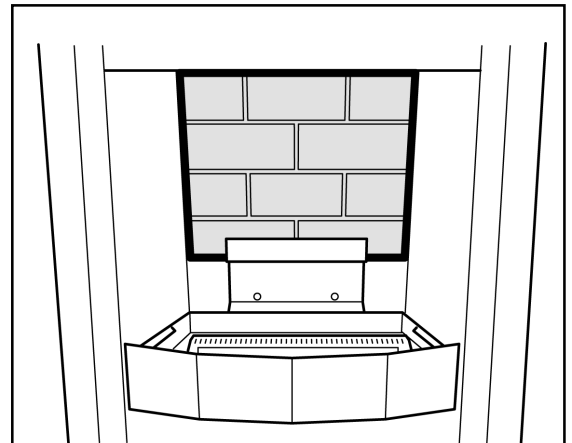

Figure 4 Ceramic Rear Wall Position

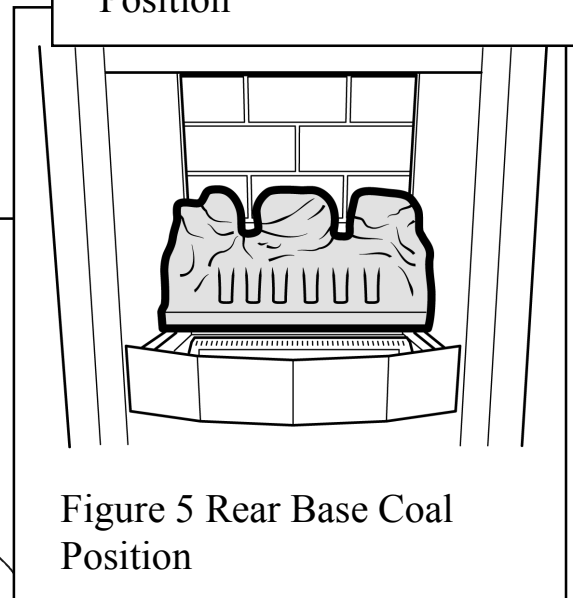

Figure 5 Rear Base Coal Position

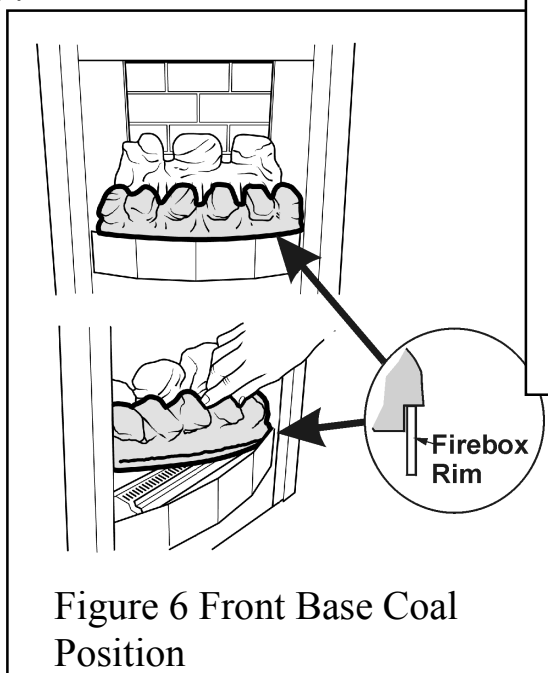

Figure 6 Front Base Coal Position

OWNER'S GUIDE

5. Place a type "A" coal between the front and rear base coals with the letter "A" upright and so that the coal is against the left side of the firebox. See figure 7.

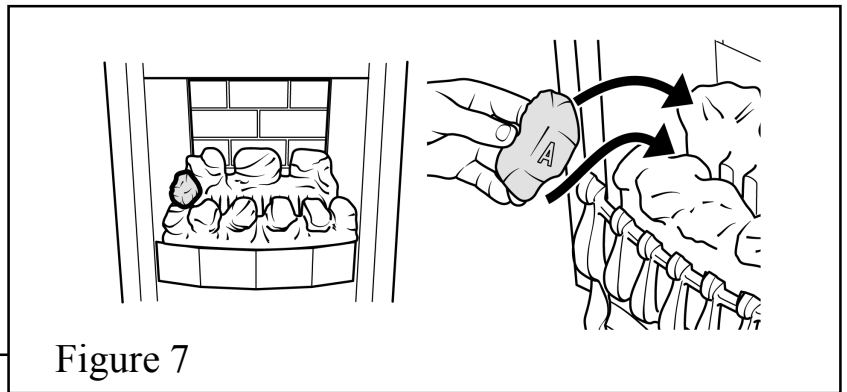

Figure 7

6. Place a type "B" coal between the front and rear base coals as shown in figure 8. The letter "B" should be upright.



Figure 8

7. Place a type "A" coal between the front and rear base coals with the letter "A" upright. The top of the coal should rest against the centre coal of the rear base coal as shown in figure 9.

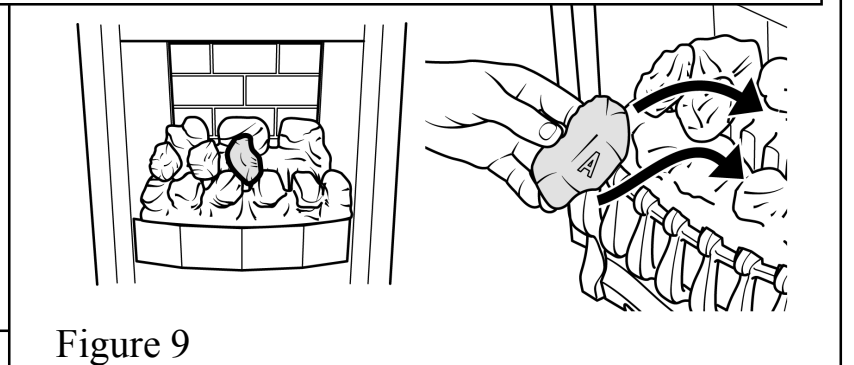

Figure 9

8. Place the remaining type "B" coal at the right side of the firebox between the front and rear base coals. The letter "B" should be upright. The coal should touch the right side of the firebox. See figure 10.



Figure 10

9. Place the remaining type "A" coal between the front and rear base coals. The letter "A" should be upside down with its rear face between the right and centre coals of the rear base coal. Angle the coal so that the gap between it and the type "B" coal to its right is appreciably larger than the gap between it and the type "A" coal to its left but do not have it touching the type "A" coal. This will give the best flame effect. See figure 11.

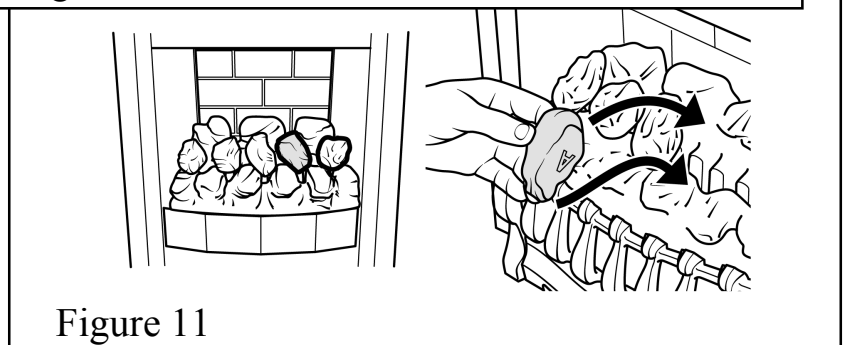

Figure 11

OWNER'S GUIDE

MAINTENANCE

Regular maintenance

In order to achieve and maintain high levels of personal safety and performance efficiency, it is essential that the opening at the back of the fire and the flue are kept clear of any form of obstruction. It is possible that deposits of mortar or soot could fall and accumulate causing the flue to be blocked or restricted and so preventing proper clearance of dangerous exhaust fumes.

In the United Kingdom it is the law that a landlord must have any gas appliance, flue and pipework which is situated in a tenant's premises checked for safety at least every twelve months by a competent person (In the U.K, a CORGI registered installer).

We recommend that all gas appliances and their flues, wherever situated, are checked annually.

Servicing

- In the United Kingdom servicing can be carried out either by a Valor Service engineer or a CORGI registered installer.
- If you require your fire to be serviced, please contact **Valor Service** on **08706 090 081** and quote the following details;
 - a) Model name and number.
 - b) Appliance serial no. (To be found on a tied label next to the control knob. It is visible when the bottom front cover is removed.)

If you wish to replace any of the owner replaceable parts listed below, please contact **Valor Spares** on **08706 000 454** for your nearest stockist of these parts. When ordering please quote the part number shown below.

Owner Replaceable Parts

<u>Description</u>	<u>Part No</u>
Ceramic rear wall	0579339
Front base coal	0579119
Rear base coal	0579129
Pack of 5 loose coals	0579149

- **When fitting replacement parts, follow the instructions contained in this guide. It is important that only Valor approved parts are used for maximum safety.**
- In the United Kingdom, for general advice about gas and your gas fire call the **VALOR TECHNICAL HELPLINE 08706 061 065.**
- In the Republic of Ireland call **0044 08706 061 065** for all enquiries.