

Wonderfire

Inset Live fuel Effect Engine

for use with

*The Gallery
Fire Collection*

Model BR218C1

**INSTALLATION AND SERVICING
INSTRUCTIONS**

Please keep in a safe place for future reference

Please leave this Installer Guide with the user

As supplied, this appliance is for use with natural gas (G20)

When converted using conversion kit no. 591149 this appliance is for use with propane gas (G31)

These appliances are for use in the United Kingdom (GB) and the Republic of Ireland (IE) only.

C U S T O M E R C A R E

This Installer Guide gives sufficient details to enable the gas appliance to be installed and maintained. If further information is required, our **Advice Line** will be pleased to help.

Please telephone 0345 626341 (Local call rates apply)

In the Republic of Ireland call 353 183 75114.

CONTENTS

Installation Notes	4
Technical specification	5
Pack Contents	5
General Installation Requirements	6
• Fire Surround.....	7
• Hearth Requirements	7
Installation and Commissioning Instructions	7
• Fireplace, flue and Ventilation Details	7
• Foam Seal	7
• Cable Retention	8
• Floor Sealing	8
• Preliminary Burner Checks	8
• Check Reference Pressure	9
Fitting the Ceramics	9
Full Operating Checks	11
• Recheck Control Settings	11
• Check for Spillage	11
• Flame Supervision & Spillage Monitoring System	11
Final Review	12
Servicing	13
• Burner Plaque Removal	13
• Burner Unit Removal	13
• Pilot Unit Removal	13
• Gas Tap Removal	14
• Piezo Generator Removal	14
• Greasing Gas Tap	14
• Injector Removal	14
• Removing Appliance	14
Short List of Spares	15

INSTALLATION NOTES

In your own interest and for safety, in the United Kingdom, it is the law that all gas appliances are installed by competent persons in accordance with the current edition of the Gas Safety (Installation & Use) Regulations and Amendments. Failure to install the appliance correctly could lead to prosecution. The Confederation for the Registration of Gas Installers (CORGI) requires its members to work to recognised standards.

This product uses fuel effect pieces, burner compartment walls and gaskets containing Refractory Ceramic Fibres (RCF), which are man-made vitreous silicate fibres. Excessive exposure to these materials may cause temporary irritation to eyes, skin and respiratory tract. Consequently, it makes sense to take care when handling these articles to ensure that the release of dust is kept to a minimum. To ensure that the release of fibres from these RCF articles is kept to a minimum, during installation and servicing we recommend that you use a HEPA filtered vacuum to remove any dust and soot accumulated in and around the fire before and after working on the fire. When replacing these articles we recommend that the replaced items are not broken up, but are sealed within a heavy duty polythene bag, clearly labelled as RCF waste. This is not classified as "hazardous waste" and may be disposed of at a tipping site licensed for the disposal of industrial waste. Protective clothing is not required when handling these articles, but we recommend you follow the normal hygiene rules of not smoking, eating or drinking in the work area and always wash your hands before eating or drinking.

This appliance does not contain any component manufactured from asbestos or asbestos related products.

The appliance data label is on the control plate below the right side of the burner tray. It is visible when the bottom front cover is removed.

The installation must be in accordance with these instructions.

In the United Kingdom the installation must also be in accordance with:

- a) All the relevant parts of local regulations.
- b) The Building Regulations issued by the Department of the Environment or the Building Standards (Scotland) (Consolidation) Regulations issued by the Scottish Development Department.
- c) All relevant codes of practice.
- d) The relevant parts of the current editions of the following British Standards:-
 - BS 715
 - BS 1251
 - BS 1289 Part 1
 - BS 1289 Part 2
 - BS 4543 Part 2
 - BS 5440 Part 1
 - BS 5440 Part 2
 - BS 5871 Part 2
 - BS 6461 Part 1
 - BS 6891

In the Republic of Ireland the installation must also conform with the relevant parts of:

- a) The current editions of:-
 - IS 813
- b) All relevant national and local rules in force.

If the appliance is intended to be installed to a chimney, which was previously used for solid fuel, the flue must be swept clean prior to installation. All flues should be inspected for soundness and freedom from blockages.

The minimum effective height of the chimney or flue must be 3m (10ft) from the hearth to the point of termination of the flue.

The chimney or flue must have any damper or restrictor removed, or permanently secured in the fully open position.

The flue must not be used for any other appliance or application.

If the fireplace opening is of underfloor draught type, it must be sealed to stop any draughts.

A fireguard complying with BS6539 or BS6778 should be fitted for the protection of young children, the elderly, or the infirm.

In the United Kingdom (GB) no special ventilation bricks or vents are required in the room for this appliance. However, any requirement relating to other appliances which may be in the same room must be taken into consideration.

In the Republic of Ireland (IE), permanent ventilation must comply with the regulations currently in force.

An extractor fan may only be used in the same room as this appliance, or in any area from which ventilation for the appliance is taken, if it does not affect the safe performance of the appliance. Note the spillage test requirements detailed further on in this manual. If the fan is likely to affect the appliance, the appliance must not be installed unless the fan is permanently disconnected.

The appliance is fitted with an A.S.D (Atmosphere sensing device). If the appliance closes down after a period of operation for no apparent reason, the consumer should be informed to stop using the appliance until the installation and appliance have been thoroughly checked. The A.S.D will shut the appliance down if an unacceptable amount of harmful products of combustion accumulate. Under no circumstances

should the A.S.D be altered or bypassed in any way. Only a genuine manufacturers replacement part should be fitted. The individual A.S.D components are not replaceable.

Note that soft wall coverings (e.g. embossed vinyl, etc.) are easily affected by heat. They may scorch or become discoloured when close to a heating appliance. Please bear this in mind when installing.

Propane gas appliances must not be installed in a room, which is built entirely below ground level (See BS 5871 Pt2).

TECHNICAL SPECIFICATION

Appliance height:	600mm
Appliance width:	470mm
Appliance depth:	115mm
Height of opening required:	535mm min. 575mm max.
Width of opening required:	335mm min. 435mm max.

Gas	Natural (G20)	Propane (G31)*
Inlet Pressure	20mbar	37mbar
Input - Max. (Gross)	6.0kW (20,500Btu/h)	6.1kW (20,800Btu/h)
Input - Min. (Gross)	2.2kW (7500Btu/h)	3.6kW (12280Btu/h)
Output - Max.	2.5kW (11,900Btu/h)	2.5kW (12,280Btu/h)
Output - Min	0.85kW (3750Btu/h)	0.85kW (6140Btu/h)
Burner Test Pressure (Cold)	17.0±0.75mbar (6.8±0.3in w.g.)	36.2±0.75mbar (14.53±0.3in w.g.)
Gas Connection	8mm pipe	8mm pipe
Burner Injector	Bray Cat. 18 Size 360	Bray Cat. 18 Size 170
Pilot & Atmosphere Sensing Device	SIT Ref. OP9030	SIT Ref. OPLPG9222
Ignition	Piezo Electric. Integral with Gas Tap	Piezo Electric. Integral with Gas Tap
Aeration	Non-adjustable	Non-adjustable

* When converted using Kit 591149

Clearance to combustible side panels: 100mm

The minimum height from the top surface of the hearth to the underside of any shelf made from wood or other combustible materials is as follows: -

- For a shelf up to 150mm deep
Minimum height = 750mm.
- For a shelf deeper than 150mm
Minimum height = 750mm + 12.5mm for every 25mm depth over 150mm.

PACK CONTENTS

- 1 Hotbox, and Burner assembly
- 1 Literature Pack
- 1 Loose parts pack including:-
 - 1 Front coal Matrix
 - 1 Rear coal Matrix
 - 1 Loose coals Pack
 - 3 Self-Adhesive Foam seals
 - 2 Tension Cables
 - 2 Cable Adjusters
 - 2 Eyescrews
 - 2 Fibre Plugs
 - 1 Strip of Floor Sealing Tape
 - 1 Nut and Olive for 8mm Inlet Pipe

Carefully remove the contents.

Take special care when handling the ceramic components.

Check that all the listed parts are present and in good condition.

GENERAL INSTALLATION REQUIREMENTS

This appliance is not suitable for installation in a room or internal space containing a bath or shower or where steam is regularly present or in a private garage.

This appliance is suitable for the following: -

1. A masonry chimney with a minimum diameter of 175mm (7") free from any obstruction, and with any damper or restrictor plate in the chimney removed or secured, and having a minimum effective flue height of 3m (10ft). Note the relevant flat surface area requirement (Figure 1). A masonry chimney having a correctly installed flue liner to BS715 and with a minimum flue diameter of 125mm is also acceptable. Chair brick removal may not be required providing at least 50mm clearance is available from the flue outlet to any fireplace component. The appliance is designed to cater for low lintel installations (min height 505mm) providing a minimum distance of 25mm is maintained between the lintel and the front face of the fireplace (i.e. 25mm rebated fire surround).
2. To a fireplace that has a precast concrete or clay flue block system conforming to BS1289. The appliance is suitable for installations conforming to older versions of BS1289 as well as the current edition. The flue blocks must have a minimum width not less than 63mm and a cross-sectional area not less than 13,000mm². Older editions of BS1289 required a cross-sectional area of 13,000mm². The current revision of the standard requires 16,500mm². This appliance is suitable in both cases. The total depth of the opening measured from the finished front of the fireplace (Including plaster, surround etc.) must be **not less than 118mm** (Figure 2). The current version of BS1289 recommends that there should be an air space or insulation between the flue blocks and the plaster because heat transfer may cause cracking on directly plastered flues. However, generally this appliance is suitable for installations under all circumstances unless there is a history of cracking problems. Remember that faults such as cracking may be caused by poorly built and restrictive flues, e.g. mortar extrusions, too many bends, flue heights below three metres, restrictive terminations, etc.

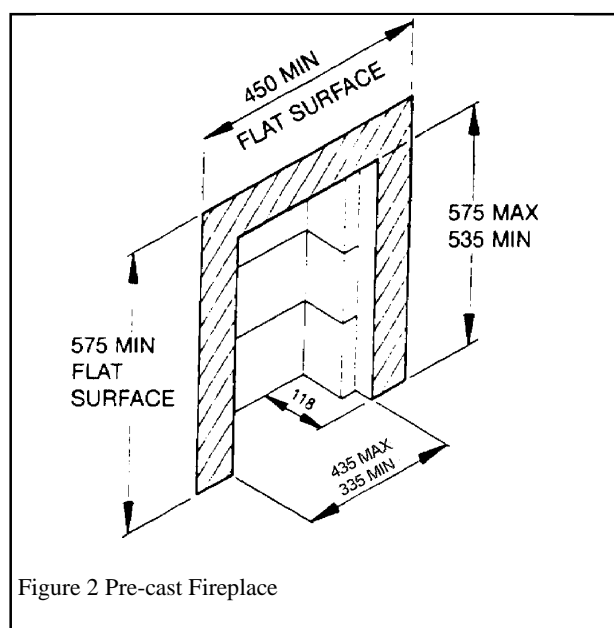
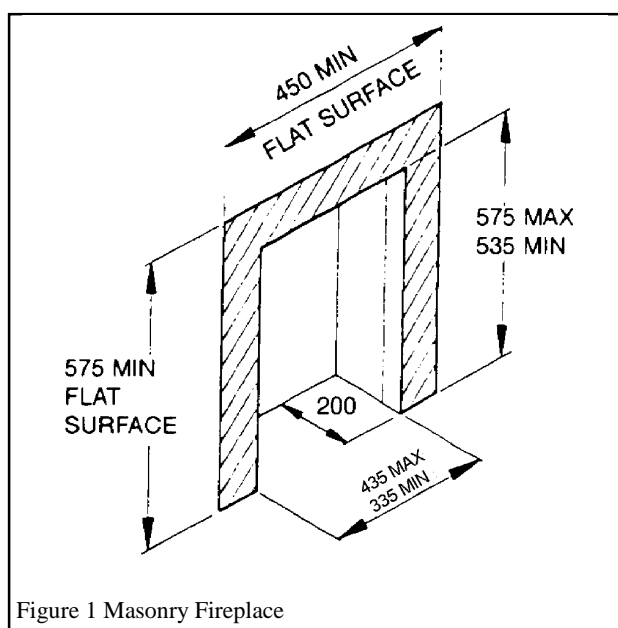

3. A sheet metal flue system conforming with BS4543 or BS715, the flue diameter being a minimum of 125mm (5") (see Figure 3) with a minimum internal depth of 150mm. Incombustible mineral wool insulation of not less than 50mm thickness must be applied to the top surface of the system firebox, as shown in figure 3.

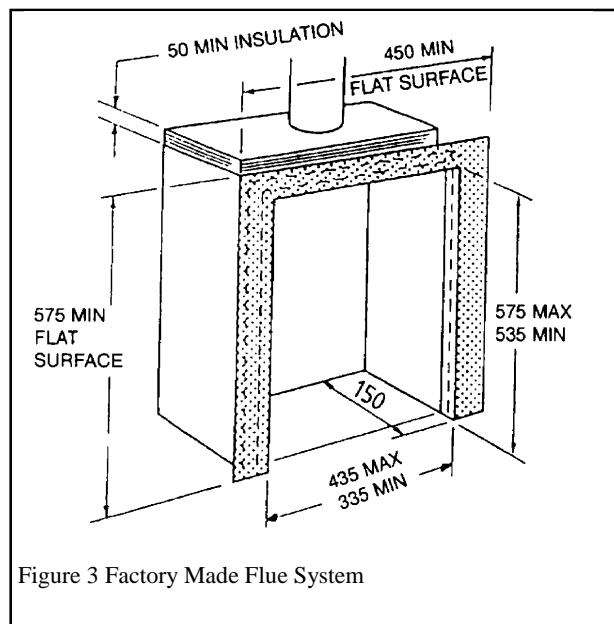

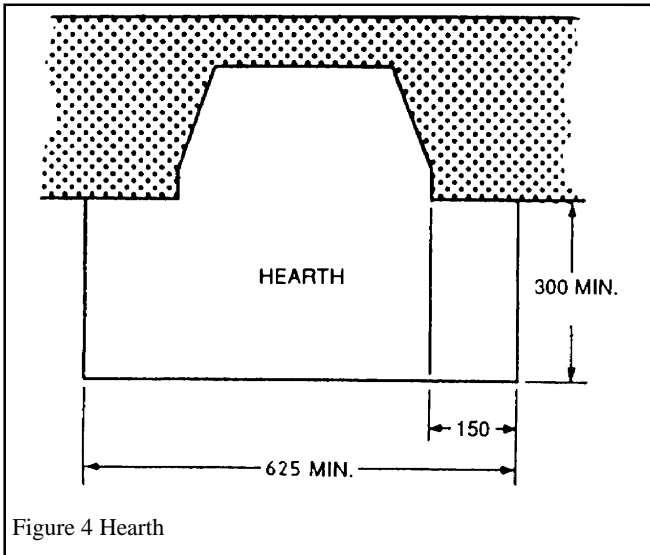

Figure 4 Hearth

Fire Surround: This appliance may be installed with a surround with a minimum approved temperature rating of 150 degrees. The fire surround must be sealed to the wall.

Hearth Requirements: The appliance must be mounted on a non-combustible hearth in accordance with Figure 4. The hearth material must have a minimum thickness of 12.5mm (1/2"). The periphery of the hearth (or fender) should be at least 50mm above floor level to discourage the placing of carpets or rugs over it.

INSTALLATION AND COMMISSIONING INSTRUCTIONS

PLEASE READ CAREFULLY BEFORE STARTING WORK

FIREPLACE, FLUE AND VENTILATION DETAILS

Read the important installation notes on the previous pages before proceeding with the installation of your fire. Only when you have complied with all the requirements should you proceed any further. *Note the hearth requirements.*

The burner is produced from a soft ceramic material and should be handled carefully.

The burner tray assembly has been tested before it leaves the factory and is in perfect working order.

Remove any transit tape and packing and inspect for any evidence of mishandling which might affect the performance. Each unit is flame tested before it leaves the factory and as a result there may be slight discoloration around the burner ports. There may also be slight thermal cracking across the burner surface that is perfectly normal and is not detrimental to performance.

8mm (5/16) Bundy or semi-rigid tubing must be used to connect the appliance to the gas supply.

Centre the appliance in the fireplace opening taking care not to scratch or damage the hearth.

If a concealed gas pipe fixing is to be used, offer the gas pipe through the appropriate grommet. A nut and olive are provided for an 8mm-pipe inlet connection to the elbow at the bottom front of the appliance. The elbow can be rotated to allow a connection from any direction. The elbow includes a valve for isolating the gas supply.

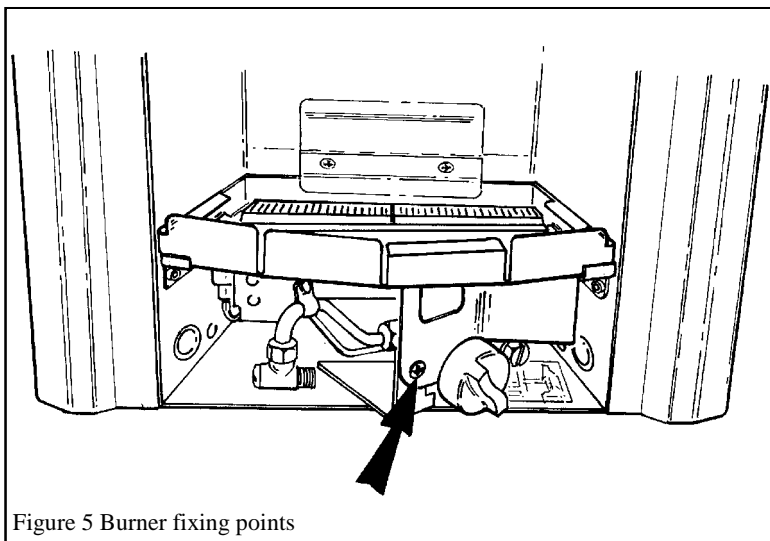

Figure 5 Burner fixing points

The burner assembly is retained by one screw set in the front leg (see Fig.5). Remove the screw and carefully remove the burner assembly by lifting and sliding forward from the firebox.

FOAM SEAL: A foam seal is supplied which will need to be attached to the rear face of the firebox frame on all three sides. Ensure that all joints are butted together to prevent air gaps.

CABLE RETENTION

Cables and eyebolts are supplied for the retention of the appliance. Ensure that the internal fireplace components are sufficiently sound to take the eyebolts and wall plugs. These should be fitted in accordance with Figure 6, using the wall plugs and a No.10 drill. Use only the fibre wall plugs supplied (or similar). **On no account should plastic wall plugs be used.**

Method: Assemble one end of the cable to the top of the fire by passing it through the small round hole and locking by positioning the cable end in the adjacent slot. Pass the other end of the cable through the eyebolt & hole in the lower side of the appliance and fit adjusters in accordance with Figure 7. With the adjusters fully screwed in, carefully manoeuvre the appliance into the fireplace opening. Take up any slack on the cables, and tighten cable nipples into position. Tighten the appliance into the fireplace opening by turning the adjuster nuts to compress the sealing foam sufficiently to provide an effective seal. Do not overtighten.

If the sealing foam does not fully compress, then the adjusters and nipples may require to be slackened and the cable pulled up tighter before re-tightening the adjuster. Do not cut off any excess cable, instead coil up the cable against the flange, as it may be required for servicing purposes.

FLOOR SEALING

Using the floor sealing tape supplied, seal the bottom of the convection box to the fireplace and hearth floor. Run the tape over the burner-fixing bracket.

Replace the burner assembly into position in the firebox, without refitting the retaining screw at this stage. Cut and shape the gas supply pipe to suit the chosen direction of entry and the gas inlet fitting position. Refit and tighten the burner assembly retaining screws. Refit the burner unit to the appliance to the front leg bracket by the screw.

Connect the supply line to the appliance.

For side connection passing in front of the surround. The supply pipe will have to be close to the inner face of the surround to the fire front casting to be correctly positioned. The pipe should pass through the cutout in the casting side.

For right hand side connection. The supply pipe will also have to be formed to go behind the control knob and burner support bracket.

Pressure check the installation pipework for gas soundness in accordance with the current edition of BS6891. A long brush may be required to reach some joints.

PRELIMINARY BURNER CHECKS

Some burner operations can be checked at this stage. Checking now will mean that less disassembly will be required if any problems are found.

A full check should still be made, however, after final installation.

If closed, open the isolating valve at the inlet elbow.

Depress the control knob and turn anticlockwise partially towards the “**PILOT/IGN**” position until some resistance is felt. Keep depressed at this position to purge air from the system then, while keeping it depressed, turn fully to the “**PILOT/IGN**” position. A spark should be generated at the pilot while turning. The spark should ignite the pilot. If not turn the control knob back to the off position and repeat the procedure.

When pilot ignition has been achieved, keep the control knob depressed for approximately ten seconds to allow the thermocouple probe to warm up and then release it. If the pilot does not remain alight, ensure that the air has been purged, that the pilot orifice is clear and that the thermocouple connections are sound. Replace the pilot unit if necessary (see servicing section of this manual).

When the pilot is alight and stable, partially depress the knob and turn to “**LOW**”. The pilot should then light the main burner at its low setting. There may be a delay of up to four seconds between the pilot lighting and ignition of the gas at the main burner. This is normal and is due to the time required to fill the main burner compartment with sufficient gas for ignition.

When the burner is operating properly, partially depress the control knob and gradually turn it anti-clockwise. The burner flames should gradually increase until the knob reaches the “**HIGH**” position.

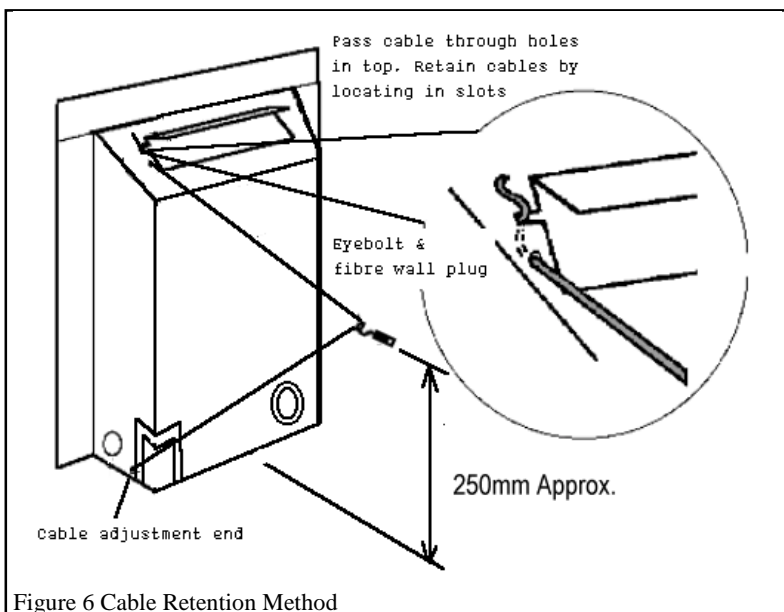

Figure 6 Cable Retention Method

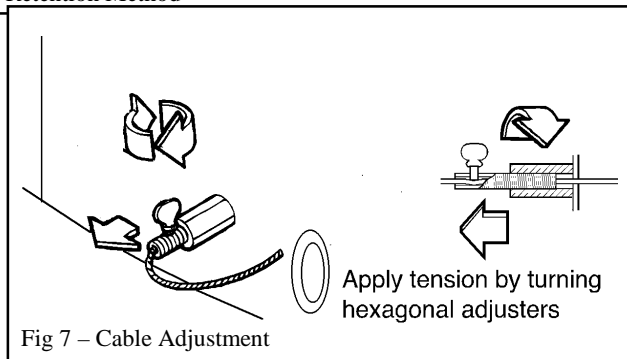

Fig 7 – Cable Adjustment

When the above checks have been completed partially depress the control knob and turn to "OFF".

If the above checks are satisfactory, continue with the installation. If not, check the control and ignition circuitry and components as described in the servicing section of this manual.

CHECK REFERENCE PRESSURE

The appliance is pre-set to give the correct heat input at the inlet pressure shown in the Technical Specification section of this manual. No adjustment is necessary. Check the burner pressure by fitting a pressure gauge at the test point. The test point is on the pipe situated below the bottom right corner of the burner unit. Check the pressure with the appliance alight and set at maximum output.

After checking, turn off the appliance. Remove the pressure gauge and replace the test point sealing screw. Relight the appliance. Turn to the maximum output position and test around the sealing screw for gas soundness with a suitable leak detection fluid.

FITTING THE CERAMICS

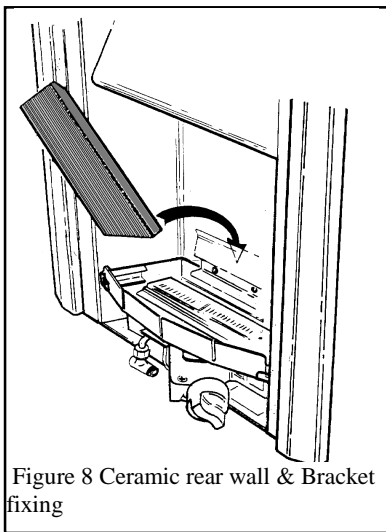

Figure 8 Ceramic rear wall & Bracket fixing

Prior to fitting the ceramics, assemble the Burner tray trim (packed loose) to the front of the burner tray. Simply hook the trim over the front flanges of the burner tray and push downwards.

Fit the ceramic rear wall (figures 8 & 9). The featheredge of the ceramic rear wall must be at the top.

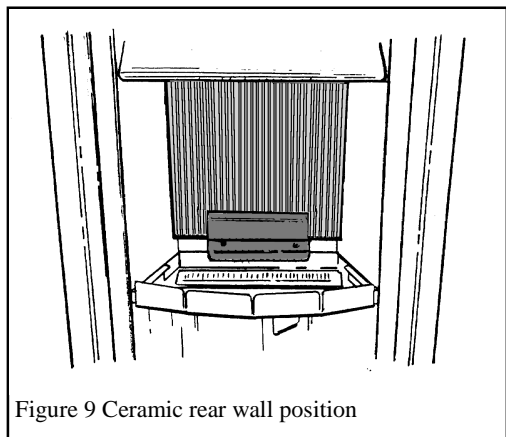

Figure 9 Ceramic rear wall position

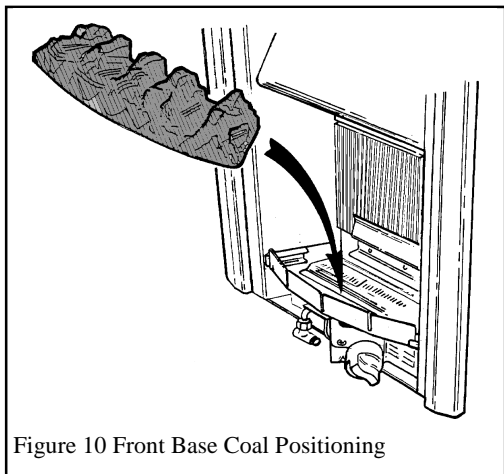

Figure 10 Front Base Coal Positioning

Place the front base coal in the burner compartment so that it rests on the ledges at the sides and front. **Pull the coal forward so that it is immediately behind the front rim of the burner compartment.** (See Fig 10 & 11).

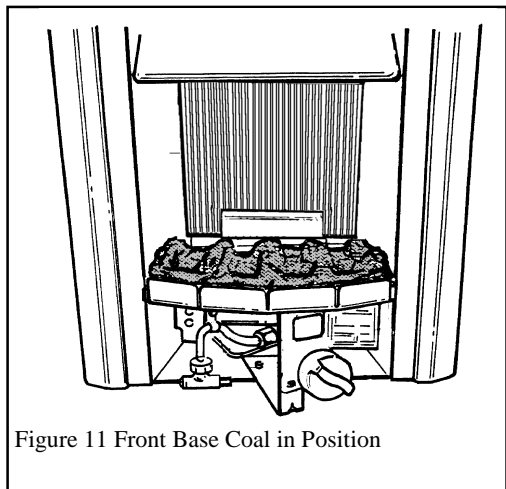

Figure 11 Front Base Coal in Position

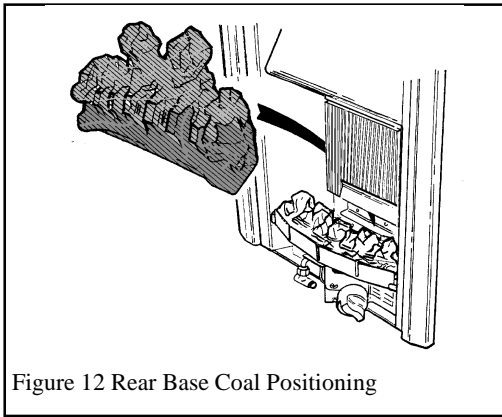

Figure 12 Rear Base Coal Positioning

Place the rear base coal in the burner compartment behind the front coal. It should rest on the ledge at the back of the burner compartment and its rear face should touch the rear ceramic wall (See Figure 12 & 13).

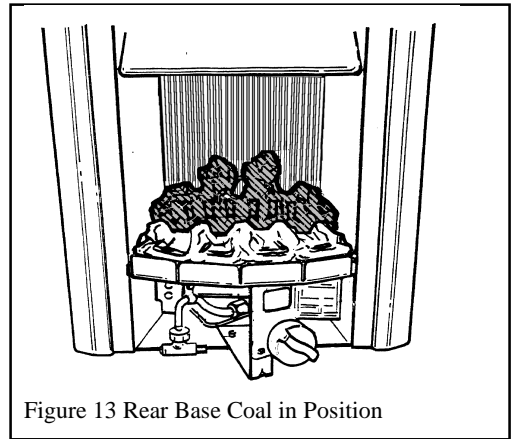

Figure 13 Rear Base Coal in Position

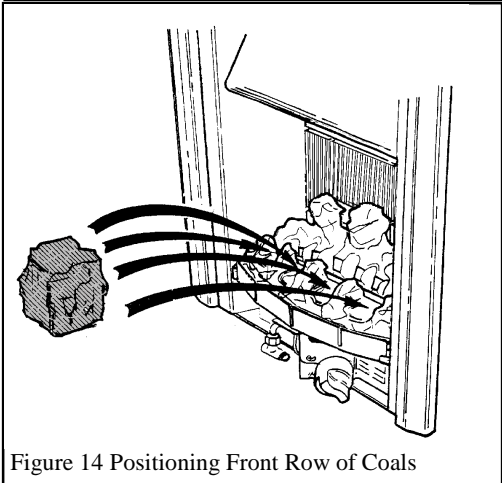

Figure 14 Positioning Front Row of Coals

Install the 9 loose coals as follows. The smooth surfaces of the coals should be at the bottom and back. Select the two smallest coals and put them aside until all the other coals are installed. Place four of the medium size coals in the four valleys of the front coal. Place the left side coal so that the customer will be able to see the pilot flame (Figures 14 & 15).

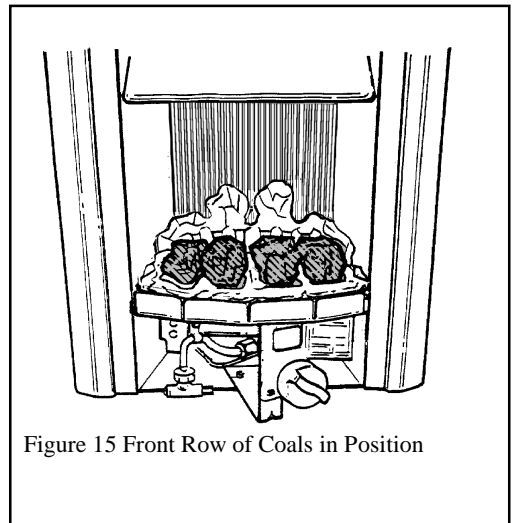

Figure 15 Front Row of Coals in Position

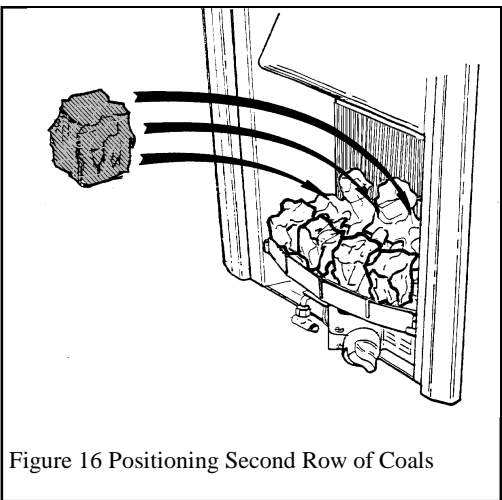

Figure 16 Positioning Second Row of Coals

Place the three remaining medium size coals behind and approximately midway between each of the coals in the front row (Figures 16 & 17).

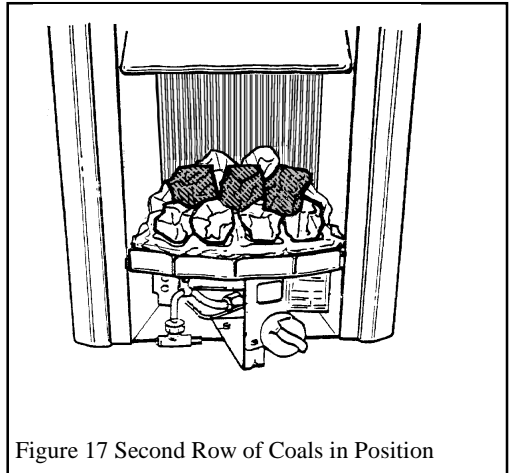

Figure 17 Second Row of Coals in Position

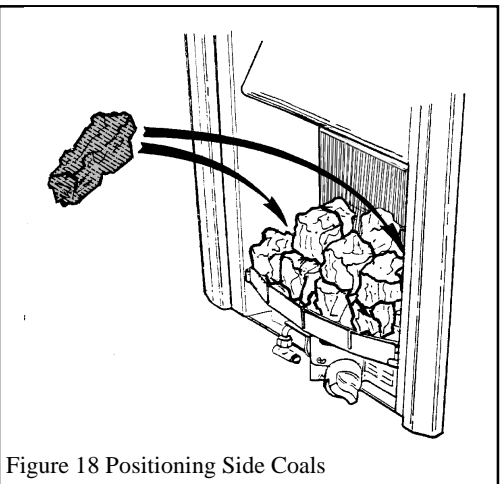

Figure 18 Positioning Side Coals

Place the two remaining small coals alongside the main coals (Figures 18 & 19).

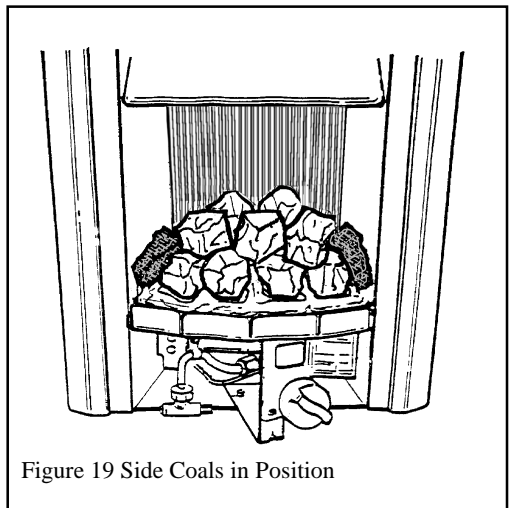

Figure 19 Side Coals in Position

FULL OPERATING CHECKS

RECHECK CONTROL SETTINGS

Now that all the ceramic fuel effects are in position, the control operation must be fully rechecked. Make sure that the isolating valve at the inlet elbow is open.

Depress the control knob and turn anti-clockwise partially towards the “**PILOT/IGN**” position. A spark should be generated at the pilot while turning. The spark should ignite the pilot. Check that the pilot flame is visible.

When pilot ignition has been achieved, keep the control knob depressed for approximately ten seconds to allow the thermocouple probe to warm up and then release it. If the pilot does not remain alight, ensure that the pilot orifice is clear.

When the pilot is alight and stable, partially depress the knob and turn to “**LOW**”. The pilot should then light the main burner at its low setting. There may be a delay of up to four seconds between the pilot lighting and ignition of the gas at the main burner. This is normal and is due to the time required to fill the main burner compartment with sufficient gas for ignition.

When the burner is operating properly, partially depress the knob and gradually turn it anti-clockwise. The burner flames should gradually increase until the knob reaches the “**HIGH**” position.

Partially depress the control knob and turn back the “**PILOT/IGN**”. The main burner flames should be extinguished but the pilot should remain alight.

Partially depress the control knob and turn to “**OFF**” the pilot should be extinguished.

CHECK FOR SPILLAGE

A spillage check must be made before leaving the installed appliance with the customer. Make this check with the appliance fully installed with the ceramic fuel effects and front surround in position.

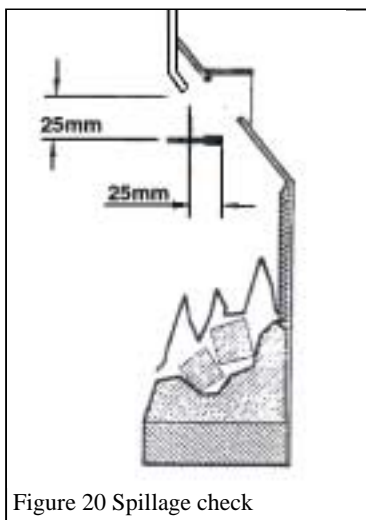

Figure 20 Spillage check

Close all doors and windows in the room containing the appliance.

Light the appliance and turn the control knob to “**HIGH**”.

Leave the appliance on for five minutes.

Place the smoke match into the appliance canopy (See Fig.20)

The installation is satisfactory if the smoke is drawn into the appliance. If the smoke is not drawn into the appliance, leave the appliance alight at the maximum setting for a further ten minutes and then repeat the test. If smoke is still not drawn into the appliance, inspect the sealing to the fireplace surround. If smoke is still not drawn into the appliance, **disconnect the appliance and seek expert advice.**

If the above test is satisfactory, open all internal connecting doors, hatches, etc., in the room. Keep all doors and windows that open to the outside of the building closed. Recheck for spillage as above. If an extractor fan is installed in the same room as the appliance or a connecting room, check that spillage does not occur with the fan operating and all doors and other openings between the fan and the appliance open.

If the smoke is drawn into the appliance, continue with the installation. If the test is not satisfactory, **disconnect the appliance and advise the customer of the cause of failure.**

FLAME SUPERVISION & SPILLAGE MONITORING SYSTEM

This pilot unit incorporates a system that will automatically shut off the gas supply if the pilot flame goes out or if there is insufficient oxygen due to spillage or lack of ventilation.

This monitoring system must not be adjusted, bypassed or put out of operation.

This monitoring system, or any of its parts, must only be exchanged using Manufacturers thorised parts.

FINAL REVIEW

Place the front casting in position between the sides of the front surround.
Place the bottom front cover casting below the front casting.

Visually inspect the appliance. Clean off any marks incurred during installation.

Hand these instructions and the user's instructions to the customer.

Advise the customer that the appliance will operate to its maximum potential if the flue is primed during the first 20 – 30 minutes of use. To do this, simply slide the control to its highest setting. This will also burn off any carbon deposits that may have formed during previous use.

If using the appliance for long periods it is beneficial to change between settings. This will also help to remove any carbon deposits that may form during use. This is explained in the Owner's manual under the section 'Operating the Fire'.

Point this out to the customer before leaving.

Explain to the customer that the appliance has a flame failure and spillage monitoring system. Point out the explanation of this system shown in the users instructions under "Operating the Fire". Advise that if the fire goes out for any reason, wait at least three minutes before relighting.

Stress that if the monitoring system repeatedly shuts off the fire, the appliance should be switched off and a specialist should be consulted.

Advise the customer that the castings, front surround, firebox and ceramic pieces can be cleaned as described in the user's instructions and that the coal pieces must be replaced as described in those instructions.

Stress that no extra coals must be added over and above those supplied with the appliance and that any replacements must only be the authorised spares. Warn that ignoring this advice could cause incomplete clearance of the products of combustion with consequent health hazards.

Recommend that the appliance should be serviced and the chimney inspected by a competent person (In the UK a CORGI registered person) at least annually.

If the appliance is in premises in the United Kingdom occupied by a tenant, point out that by law a landlord must have any gas appliance, flue and pipework which is situated in a tenant's premises checked for safety at least every 12 months.

SERVICING & PARTS REPLACEMENT

Always turn off the gas supply before commencing any servicing. (The inlet elbow for this appliance incorporates an isolating valve).

This product uses fuel effect pieces, burner compartment walls and gaskets containing Refractory Ceramic Fibres (RCF), which are man-made vitreous silicate fibres. Excessive exposure to these materials may cause temporary irritation to eyes, skin and respiratory tract. Consequently, it makes sense to take care when handling these articles to ensure that the release of dust is kept to a minimum. To ensure that the release of fibres from these RCF articles is kept to a minimum, during installation and servicing we recommend that you use a HEPA filtered vacuum to remove any dust and soot accumulated in and around the fire before and after working on the fire.

When replacing these articles we recommend that the replaced items are not broken up, but are sealed within a heavy duty polythene bag, clearly labelled as RCF waste. This is not classified as "hazardous waste" and may be disposed of at a tipping site licensed for the disposal of industrial waste. Protective clothing is not required when handling these articles, but we recommend you follow the normal hygiene rules of not smoking, eating or drinking in the work area and always wash your hands before eating or drinking.

- Check that the appliance is clean and that soot or debris is not blocking the gaps between the coals causing an imperfect flame.
- Check that soot or debris is not impairing the electrode spark or pilot burner.
- Check that soot or debris is not blocking any of the slots in the main burner.
- After servicing, make sure that the ceramic walls and coals are replaced correctly as described in the installation instructions.
- **Always test for gas soundness and spillage after servicing the appliance.**

TO REPLACE BURNER PLAQUES

- Remove the 9 loose coals, front base coal, and rear base coal.
- Remove the plaque clamping strips by detaching 6 screws.
- Remove the plaques and the combination gasket between and under the plaques. If necessary remove the gauze and the gasket beneath it.
- If necessary fit a new gasket below the gauze. Clean and replace the gauze. Fit a new combination gasket below the plaques. Push the gasket ends inwards to form a dividing gasket between the plaques.
- Place the new left hand plaque in position. The left side of the plaque must touch the inside edge of the retaining flange at the left side of the burner well.
- Place the new right hand plaque in position. Make sure that the centre section of the combination plaque is between the two plaques. If there is any play between the plaques and the end retaining flanges, push the plaques firmly to the left squeezing the centre section of the combination gasket between the two plaques. Any gap should be between the right side of the plaque and the right side-retaining flange.
- Fit the front and rear plaque clamping strips. Make sure that the plaques are as far to the left as possible. ***It is important that the left side plaque is accurately positioned so that it has the correct relationship to the pilot.*** Fully tighten the clamping strips.
- Refit the ceramic fuel effects and walls as described in this manual.

TO REMOVE THE COMPLETE BURNER UNIT

- Remove the 9 loose coals, front base coal and rear base coal.
- Support the inlet isolating elbow to avoid straining the pipework and disconnect the appliance from the elbow.
- Detach the burner unit from the hotbox by removing 1 screw (As shown in figure 5).
- Replace in the reverse order.

TO REMOVE THE PILOT UNIT

- Remove the burner unit - See previous section.
- Disconnect the electrode lead from tab underneath the electrode.
- Undo the thermocouple nut at the gas tap.
- Disconnect the pilot pipe from the pilot unit elbow.
- Remove the first screw securing the dust cage to the pilot unit / burner. Carefully remove the dust cage and place aside.
- Remove the second screw securing the pilot unit to the burner. Remove the pilot unit and place it aside
- Refit in the reverse order

Note 1 The pilot unit must be replaced as a whole assembly. Its individual components are not separately replaceable.
2. Once removed, ensure that the dust cage is cleaned before refitting. Make sure that it locates squarely onto the pilot unit without any gaps between the cage edges and the pilot unit.

TO REMOVE THE GAS TAP/F.S.D

- Remove the burner unit.
- Disconnect the electrode lead from tab underneath the electrode.
- Undo the thermocouple nut at the gas tap
- Disconnect the inlet pipe at the tap end
- Disconnect the pilot pipe at the tap end.
- Disconnect the main burner pipe at the tap end
- Pull off the control knob
- Remove the gas tap fixing nut. Pull the tap clear of the control plate.
- Replace in the reverse order.

TO REMOVE THE PIEZO GENERATOR

- Remove the gas tap/F.S.D. as above
- Make sure that the tap is in the off position
- Remove the circlip holding the piezo unit to the tap. Remove the piezo unit.
- Replace in the reverse order.

TO GREASE THE CONTROL TAP/F.S.D

- Detach the tap and remove the piezo generator making sure that the tap is in the off position.
- Remove the two screws from the head of the tap. Remove the nutting head and spindle complete with collar and spring.
- Note the position of the slot in the plug - mark its position on the tap body.
- Remove the plug rotating slightly while pulling.
- Clean and grease the plug lightly with suitable grease. Do not apply excessive grease. Particularly, make sure that the gas ports in the tap are not restricted by grease.
- Push the plug into the tap body and position the slot in line with the mark previously made on the tap body.
- Reassemble the nutting head and spindle complete with collar and spring making sure that the components are correctly engaged. Check the operation of the tap.
- Refit the piezo generator.

TO REMOVE THE MAIN BURNER ELBOW INJECTOR

- Remove the burner unit – as above.
- Disconnect the main burner pipe from the injector at the venturi end. If necessary, loosen the pipe at the gas tap end to swing the pipe clear of the injector.
- Unscrew the injector from the rear support bracket.
- Refit in the reverse order.

TO REMOVE THE APPLIANCE FROM THE FIREPLACE

- Remove the 9 loose coals, front base coal and rear base coal.
- Slacken the hexagonal adjusters on the cable retainers and unscrew to release the cables.
- Refit as described in the relevant installation sections. Make sure gas soundness, sealing spillage test and performance are satisfactory.

SHORT LIST OF SPARES

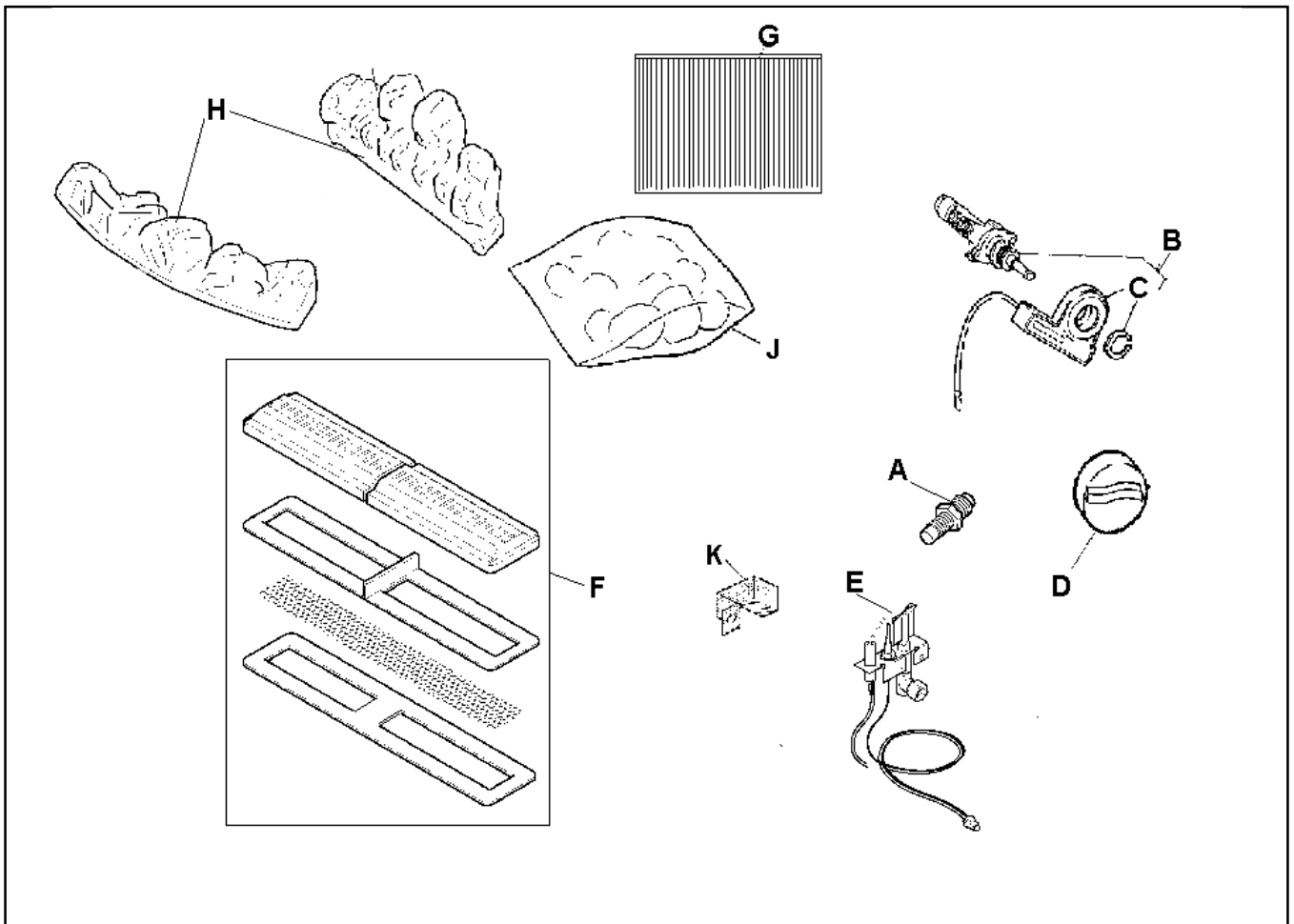

KEY	DESCRIPTION	NO. OFF	PART NO.
A	Injector Bray cat 18 size 360 <i>For Natural Gas Appliances</i>	1	541069
	Injector Bray cat 18 size 170 <i>For Propane Appliances</i>		571709
B	Gas tap & spark generator	1	569429
C	Spark generator	1	521069
D	Control knob	1	545979
E	Pilot unit <i>For Natural Gas Appliances</i>	1	540979
	Pilot unit <i>For Propane Appliances</i>		566929
F	Burner plaque & gasket set	1	569439
G	<i>Ceramic rear wall</i>	<i>1</i>	<i>576879</i>
H	Front coal	1	9770074
I	Rear base coal	1	9770075
J	Pack of loose coals	1	9780033
K	Dust cage	1	567619

All Wonderfire appliances are CE Approved and designed to meet the appropriate British Standards.



All Wonderfire appliances are manufactured to the highest standards of quality and excellence and are manufactured under a BS EN ISO 9001 quality system accepted by the British Standards Institute.



All Wonderfire gas appliances must be installed by a competent Corgi Registered Installer in accordance with our Installer Guide. If in doubt always use the services of a CORGI Registered Supplier.



Wood Lane, Erdington, Birmingham B24 9QP

Because our policy is one of constant development and improvement, details may vary slightly from those given in this publication