

VALOR FIRES

INSTALLER AND OWNER GUIDE

Model 831

ELECTRIC HEATER

Fitted with one of the following fascia.

Fantasy, Glamour,
Landscape, Manhattan,
Parker, Visia or Vivo Black Glass.

(GC No. EF-032-17)



This guide is intended to help you install and care for your Valor Fires electric heater. Please read carefully before installing and using your heater. However, if further information is required, our **Valor Fires Technical Helpline** will be pleased to help.

Telephone **0844 8711 565** (National call rates apply in the United Kingdom).

In the Republic of Ireland

Telephone **0044 844 8711 565**.



BAXI • VALOR • WONDERFIRE

Important: Please keep your guide in a safe place for future reference.

INSTALLER AND OWNER GUIDE

© Baxi Heating U.K. Limited 2009.

All rights reserved. No part of this publication may be reproduced in any material form (including photocopying), stored in any medium by electronic means (including in any retrieval system or database) or transmitted, in any form or by any means, whether electronic, mechanical, recording or otherwise, without the prior written permission of the copyright owner.

Applications for the copyright owner's permission to reproduce any part of this publication should be made, giving details of the proposed use, to the following address: The Company Secretary, Baxi Heating UK Limited, The Wyvern Business Park, Stanier Way, Derby, DE21 6BF.

Warning: Any person who does any unauthorised act in relation to a copyright work may be liable to criminal prosecution and civil claims for damages.

VALOR FIRES

Valor Fires, Erdington, Birmingham B24 9QP.
www.firesandstoves.co.uk

Because our policy is one of constant development and improvement, details may vary slightly from those given in this publication

INSTALLER AND OWNER GUIDE

Safety First.

Valor Fires heaters are CE Approved and designed to meet the appropriate British Standards and Safety Marks.



Quality and Excellence.

All Valor Fires heaters are manufactured to the highest standards of quality and excellence and are manufactured under a BS EN ISO 9001 quality system accepted by the British Standards Institute.



CUSTOMER CARE

Thank you for choosing Valor Fires

All Valor Fires heaters are designed to meet the most stringent quality, performance and safety requirements to provide our customers with many years of trouble free service. This guide aims to improve your understanding and appreciation of your new Valor Fires heater, by providing simple and informative instructions to enable you to install it and to ensure that you benefit from the excellent performance and features it has to offer.

If you require further assistance, the **Valor Fires Technical Helpline** will be pleased to help.

Please telephone **0844 8711 565** (local rates apply in the United Kingdom). In the Republic of Ireland please telephone **0044 844 8711 565**.

INSTALLER AND OWNER GUIDE

1. HANDLING AND UNPACKING

Before continuing any further with the installation of this heater please read the following:

Important instructions.

- The approximate lifting weight of the heater is as below:

<u>Model</u>	<u>Heater Body (kg)</u>	<u>Fascia (kg)</u>	<u>Total (kg)</u>
Fantasy	9.6	10.85	20.45
Glamour	9.8	12.5	22.3
Landscape	9.6	10.85	20.45
Manhattan	9.6	10.85	20.45
Parker	9.6	3.1	12.7
Visia	9.6	7.4	17.0
Vivo Black Glass	9.6	8.66	18.26

- One person should be sufficient to lift the heater. If for any reason this weight is considered too heavy then obtain assistance.
- When lifting always keep your back straight. Bend your legs and not your back.
- Avoid twisting at the waist. It is better to reposition your feet.
- Avoid upper body / top heavy bending. Always bend from the knees rather than the waist. Do not lean forward or sideways whilst handling the heater.
- Always grip with the palm of the hand. Do not use the tips of fingers for support.
- Always keep the heater as close to the body as possible. This will minimise the cantilever action.
- Use gloves to provide additional grip.
- Always use assistance if required.

2. SAFETY

This appliance is not intended for use by persons (including children) with reduced physical, sensory or mental capabilities, or lack of experience and knowledge, unless they have been given supervision or instruction concerning use of the appliance by a person responsible for their safety.

Children should be supervised to ensure that they do not play with the appliance.

INSTALLER AND OWNER GUIDE

Always

- **Always** install the heater in accordance with this guide. If in doubt obtain expert advice.
- **Always** make sure the electrical socket is accessible and located adjacent to, but not above or behind the heater.
- **Always** disconnect the heater from the electrical supply before carrying out cleaning, maintenance or replacing the lamps.
- **Always** make sure the heater is firmly secured to the wall.
- **Always** use a fireguard when young children, infirm persons and pet animals can come into contact with the heater.
- **Always** use genuine Valor Fires spares.

Never

- **Never** leave children unsupervised in a room where the heater is ON and unguarded.
- **Never** obstruct or cover the fan outlet or force items into heater openings.
- **Never** install or use the heater anywhere where water is in use, i.e. Bathrooms, Kitchens, Shower Rooms, Swimming Pools etc.
- **Never** use aerosols or steam cleaners on or around the heater.
- **Never** route the electric cable under carpet etc.
- **Never** install the heater close to curtains or combustible materials.
- **Never** use the heater to dry clothes etc.
- **Never** sit or stand on the heater.
- **Never** fit a shelf or position soft furnishings such as curtains above the heater.
- **Never** use the heater with a timer switch or similar device.

Important Electrical Safety

The heater must **not** be located in front of or under an electrical socket, the socket must always be accessible in order to disconnect the heater from the electrical supply for maintenance and cleaning.

CAUTION: In order to avoid a hazard due to inadvertent resetting of the thermal cut out, this appliance must **not** be supplied through an external switching device, such as a timer, or connected to a circuit that is regularly switched on and off by the utility.

Important! This heater must be earthed.

- The heater is supplied with a 3 pin 13 Amp fused re-wireable plug with 1mm² 3 core cable.
- The wires in the cable are coloured in accordance with the following code: -
 - Live =Brown
 - Neutral = Blue
 - Earth = Green /Yellow
- The electric supply must be safely routed from the heater to an electrical socket.

INSTALLER AND OWNER GUIDE

If the electric cable is damaged, to avoid a hazard it must be replaced by a Valor Fires authorised service agent, or similarly qualified person. All external wiring between the heater and the electrical supply shall comply with current IEE regulations. Extension leads should not be used.

3. FITTING THE HEATER

The installation of this heater requires a reasonable level of DIY skills. Please read this guide thoroughly before commencing installation and if in doubt, seek help from a competent person.

Important: Before continuing with the installation of this heater please ensure that you have completed the information on the last page of this guide.

Do I need any tools?

You will need the following tools: -

- **Pozidrive / Phillips / cross head screwdriver.** This should have a number 2 size tip.
- **Power drill** (Preferably with hammer action). This is only required if drilling into brick work. An appropriate size drill bit will be required for the wall plugs supplied.

Where can I fit the heater?

This heater can be fitted onto a flat wall. Ideally fix the heater through to brick work, block work or the internal wooden frame of a plaster board wall. If the wooden frame behind the plasterboard is not accessible use a minimum of four heavy duty cavity fixings.

We do not recommend that the heater be fitted to a wall covered in blown vinyl wallpaper or polystyrene tiles etc.

It is important that the heater is never fitted under a shelf or soft furnishings such as curtains.

If the heater is to be mounted on to a plasterboard wall that has a wooden frame behind it then the integrity and ability of the wall to carry the weight of the appliance must be confirmed. It is important that any vapour control barrier is not damaged, and that the structural members of the house are not damaged. We recommend a minimum 12mm thick plasterboard.

Model	Fantasy / Manhattan	Glamour	Landscape/ Parker	Visia	Vivo Black Glass
Width (mm)	930	935	930	930	740
Height (mm)	560	560	560	560	573
Depth (mm)	151	149	151	149	144

INSTALLER AND OWNER GUIDE

Heater Fixing.

All of the fixings and loose parts supplied with the heater have been identified as in figure 1.







Contents	Quantity	(Illustrations are not to scale)
Heater	1	
Hanging bracket	1	
Plasterboard fixings	6	
Pack of pebbles	2	
Wall plug	6	
Wood screw	6	
M5 x 25mm screw	2	

Figure 1. Contents. Fascia not shown (Items are not to scale)

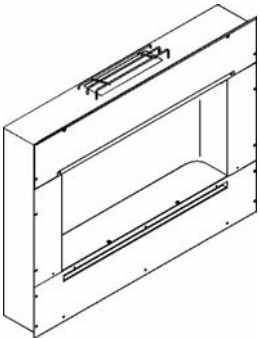
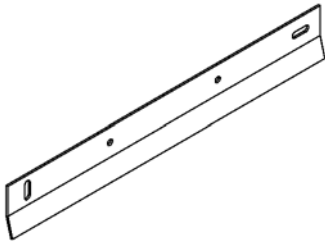
INSTALLER AND OWNER GUIDE

Fitting the heater.

- Decide the location of the heater. It is important that the heater is never fitted under a shelf or soft furnishings such as curtains.
- If fitting to a conventional brick wall then use the outer slotted holes in the bracket. If fitting to a plasterboard wall that has a wooden frame behind it then use all four fixing holes in the bracket. This is required to spread the load. Mark the positions of the hanging bracket holes on the wall (See figure 2). There is a 150mm clearance required under the heater to open the lamp access covers.
- Drill the marked positions using a suitable sized drill bit for the chosen fixings.
- Insert the wall plugs / fixings and secure the bracket to the wall using suitable screws.
- Locate the heater onto the wall bracket.
- On the base of the heater are two thumbscrews (See figure 3). Unscrew and remove the thumbscrews and light baffle.
- Mark the position of the lower support bracket hole on the wall.
- Remove the heater from the wall bracket.
- Drill the marked position using a suitable sized drill bit for the chosen fixings.
- Locate the heater onto the wall bracket and secure the lower support bracket using a suitable screw.
- Locate the light baffle and secure in place using the two thumbscrews removed previously.

The lower support bracket must always be used. This prevents the heater lifting from the hanging bracket.

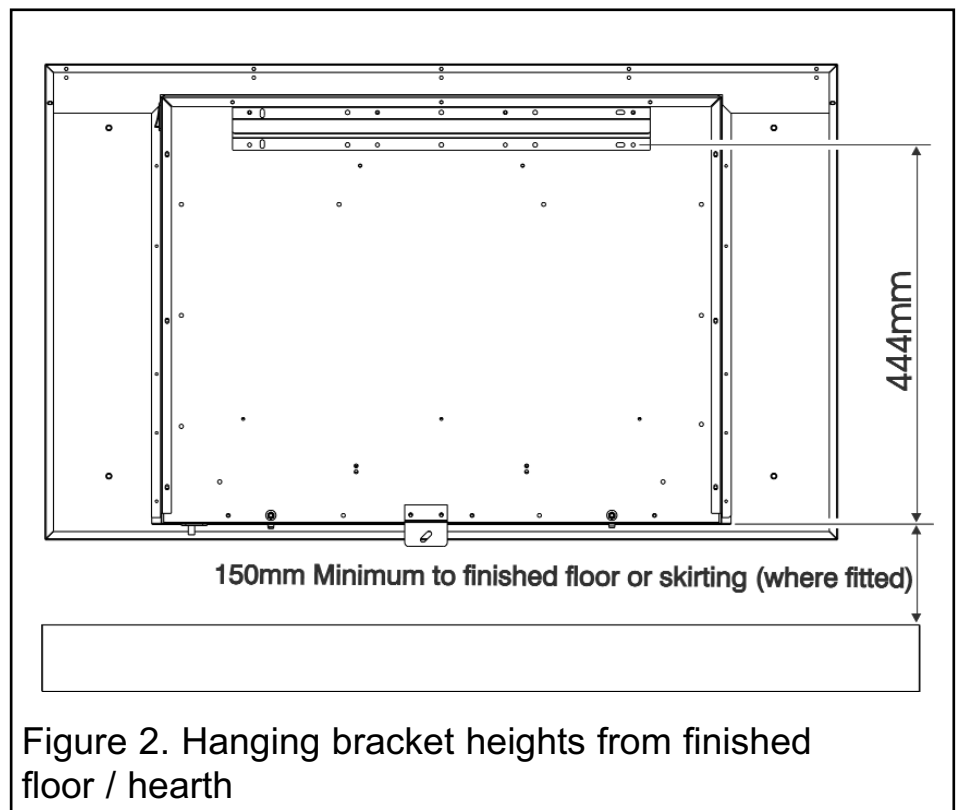

Figure 2. Hanging bracket heights from finished floor / hearth

INSTALLER AND OWNER GUIDE

Fitting the fascia.

Important: Before fitting the fascia ensure that you have completed the information on the last page of this guide.

- Place the loose pebbles onto the fuel support. It is not necessary to use all the pebbles supplied.
- Locate the top of the fascia behind the top flange of the heater.
- The fascia is secured using the two M5 x 25mm screws with bright metal finish. These are located as in figure 3.
- On Visia and Glamour models the glass panel that forms part of the fascia is supplied separately. Locate the glass panel hanging hooks into the slots in the heater body (See figure 4).

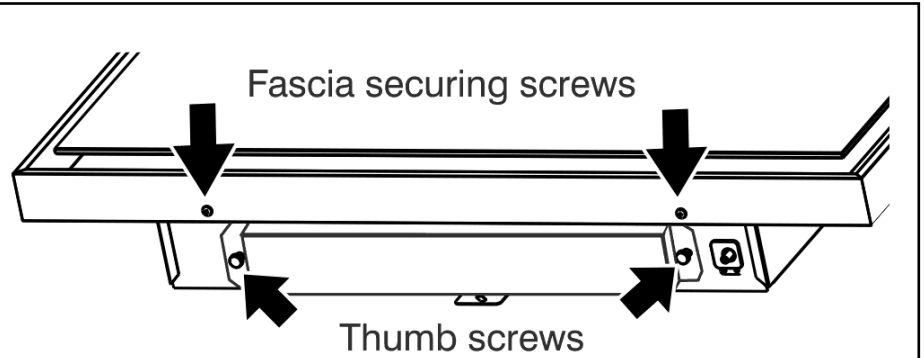

Figure 3. Underside of heater (Shown with Glamour fascia)

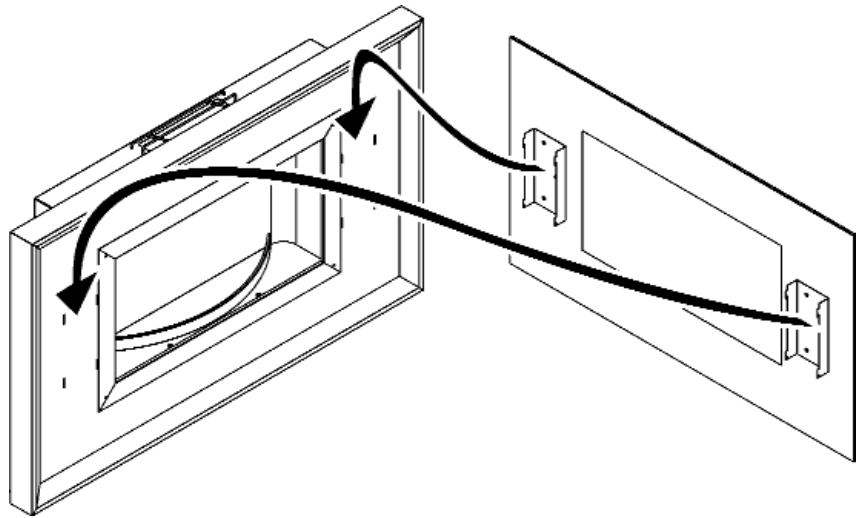

Figure 4.

INSTALLER AND OWNER GUIDE



4. USING THE HEATER

Important Safety

Never cover the heater or obstruct any openings on the heater, this could cause overheating and consequent risk of fire.

What are the three switches for?

The heater is operated by three switches located on the right hand side of the heater.

- Switch 1 =  Main On - Off. (In the 'ON' position, only the flame effect operates)
- Switch 2 =  1kW fan heat setting and flame effect. (Switch 1 needs to be in the 'ON' position to enable switch 2 to operate).
- Switch 3 =  2kW fan heat setting and flame effect. (Switches 1 and 2 need to be in the 'ON' position to enable switch 3 to operate).

5. CLEANING AND MAINTAINING THE HEATER

How do I Clean my heater?

The heater fascia and glass parts need only to be wiped clean with a dry soft cloth, do not use polishes or abrasive materials.

I have a problem with my heater!

Important Safety

Before undertaking maintenance or replacing the lamp(s) always disconnect the heater from the electricity supply by removing the 3 pin plug and allowing the heater to cool.

1. My heater is on but there is no light / low light.

This is possibly a lamp failure. Remove the lamp as below and check it in a table lamp that is known to work. If it does not work in the table lamp then replace it as below.

The lamps fitted to this heater are 60 Watt E27, 240 Volt, Edison fitting with a clear finish. Due to the indeterminate life span and ease of replacement, they are specifically excluded from the guarantee.

INSTALLER AND OWNER GUIDE

To replace the lamp.

- At the base of the heater are two thumb screws (See figure 3) that secure the light baffle. To gain access to the lamps unscrew the thumb screws and remove the light baffle.
- There are two thumb screws (See figure 5) that secure the lamp access covers. To gain access to the lamps unscrew the thumb screw and lower the access panel (See figure 6).
- Unscrew the faulty lamp in a counter clockwise direction and replace with a maximum 60 Watt E27, 240 Volt, Edison fitting with a clear finish.
- Close the access cover and secure with the thumbscrew removed previously.

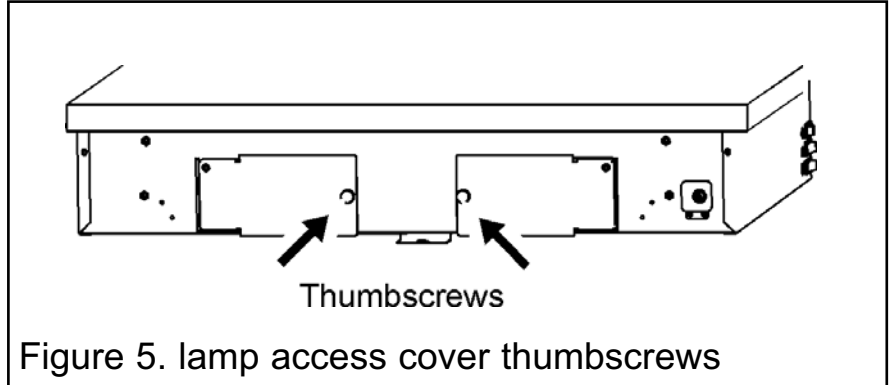

2. My heater is on but there is no light or heat.

The first thing to do is check the wall socket. To do this plug in a known working appliance. If the appliance you have plugged in works then there is a good chance that the problem lies with the 13 Amp fuse in the heater plug. If either fuse or socket is suspected, have them checked by an electrician.

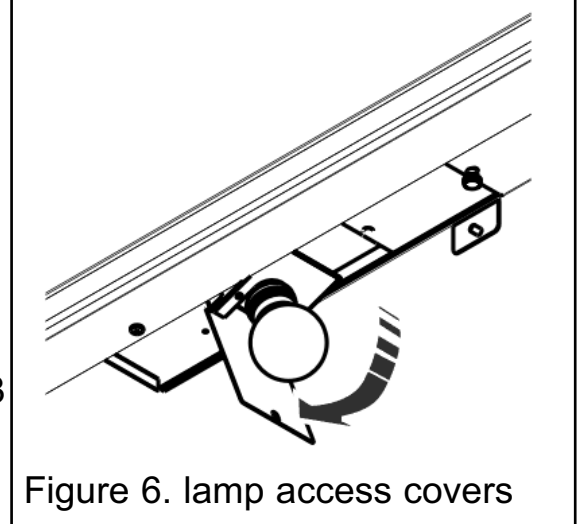

3. My heater is on but there is no heat.

A cut out device is fitted to the heater to prevent damage due to over heating. If it operates due to an obstruction in the airflow, the heater must be turned off and allowed to cool for 15 minutes and the obstruction removed before restarting.

4. I Have a problem that is different to those in the previous examples 1- 3.

For general advice about your heater, to report faults, arrange for your heater to be serviced, or for sales and product information call 0844 8711 565. Callers in the Republic of Ireland please telephone 0044 844 8711 565.

For spares inquiries

Spare parts are available nationwide via the 'interpart stockist network'. For your local stockist consult Yellow pages under 'Central Heating'.

INSTALLER AND OWNER GUIDE

6. ENVIRONMENT

What should I do when I'm ready to dispose of my heater?

The plug should be removed from the mains cable and the mains cable cut from the heater. These should be disposed of with the heater.

Environmental Protection.



Waste electrical products should not be disposed of with household waste. Please recycle where facilities exist. Check with your local authority or retailer for recycling advice.

7. WARRANTY AND SERVICE

Information for the customer

Standard Warranty Terms & Conditions

The warranty is for 12 months subject to contract.

In the United Kingdom servicing can be carried out either by a **heateam** service engineer or a suitably qualified person.

You must register your heater with **heateam**, the service division of Baxi Heating UK Limited, either by completing and returning the registration card or calling our free telephone registration line on **0800 032 72 44**.

Our promise to you

If you experience a fault with your new heater, we aim to provide a safe and high quality repair service supported by our dedicated national network of highly skilled engineers. Nothing in this warranty will affect your statutory rights.

What you need to do if you experience a problem with the operation of the heater;

Read section 5 of this guide "Cleaning and maintaining the heater". If the problem cannot be resolved simply call our service division **heateam** on **0844 8711 565** to book an engineer visit or for any general advice that you may need. Our contact centre is open Monday to Friday 8am – 6pm, weekends and Bank Holidays 8.30am – 2pm, excluding Christmas Day and New Years day.

INSTALLER AND OWNER GUIDE

When calling **heateam**, it would be helpful if you could have the following information to hand:-

1. Heater serial number
2. Heater brand and model number
3. Date of installation
4. Proof of purchase (If you do not have the heater serial number)

Note: details 1 – 3 can be found on the last page of this guide.

What this warranty covers

Free of charge repair or replacement of components found to be of faulty manufacture.

Free of charge replacement of the complete unit providing the failure is related to a manufacturing fault that cannot be repaired or is uneconomic to repair.

What this warranty does not cover

Repairs to heaters which haven't been installed properly and as set out in this guide.

Faults caused by inadequate supply of electricity.

Reimbursement of any third party repair or replacement costs that we haven't been told about or agreed with you in advance.

Compensation or consequential losses (e.g. loss of earnings, business losses, stress and inconvenience) arising from a production breakdown, including repair delays caused by factors outside our reasonable control.

INSTALLER AND OWNER GUIDE

INSTALLER AND OWNER GUIDE

To be completed by the customer:

Model

8	3	1
---	---	---

Serial number (Can be found on the information label - See figure 7)

--	--	--	--	--	--	--	--	--	--	--	--	--	--

A LABEL CONTAINING THE SERIAL NUMBER MAY HAVE BEEN PLACED INSIDE THIS BOX.

Fascia name (Block Capitals)

Fascia code - Can be found close to the information label (Block Capitals)

--	--	--	--	--	--	--	--	--	--	--	--	--	--

A LABEL CONTAINING THE FASCIA CODE MAY HAVE BEEN PLACED INSIDE THIS BOX.

Brand (Please tick)

Baxi

Valor

Wonderfire

Other.....

Date of Installation

D	D	M	M	Y	Y

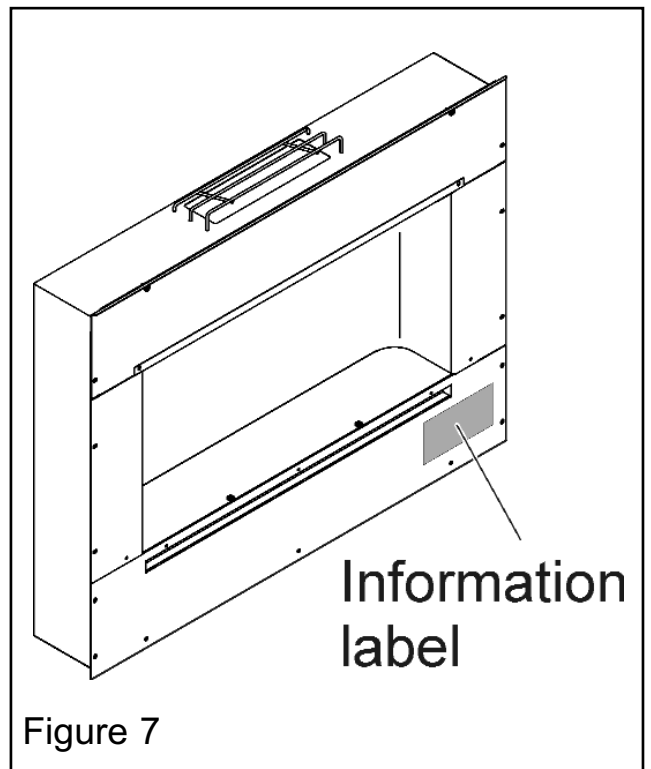

Figure 7

VALOR FIRES