

climaVAIR

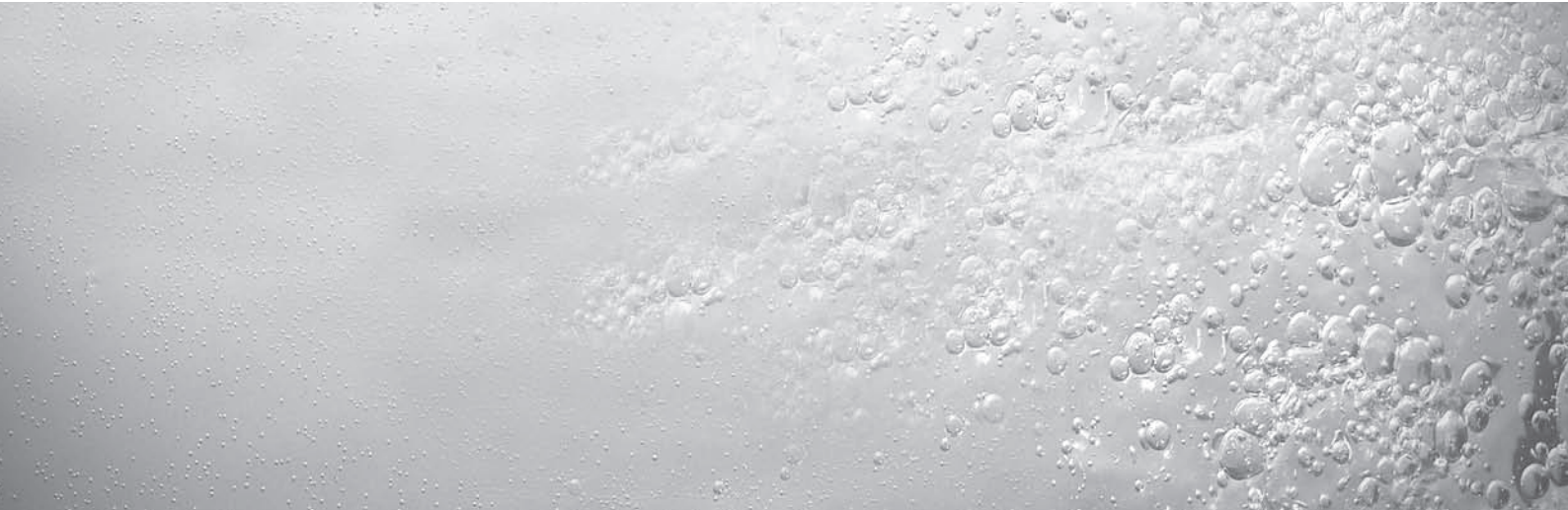

V 7-025 NW
V 7-035 NW
V 7-050 M2N
V 7-060 M2N
V 7-075 M3N
V 7-085 M3N

For the user

User Manual

Air Conditioner - climaVAIR

Split Type

V 7-025 NW
V 7-035 NW
V 7-050 M2N
V 7-060 M2N
V 7-075 M3N
V 7-085 M3N

Contents

Contents

1	Your Safety	3	8	Advice for saving Energy	21
1.1	Symbols used	3	8.1	Suitable ambient Temperature	21
1.2	Proper Use of the Unit	3	8.2	Eliminating Heat or Cold Sources	21
2	Extreme Operating Conditions	3	8.3	Operation in Heating Mode (Heat Pump)	21
3	Identification of the Unit	4	8.4	Ambient Temperature when absent	21
4	Declaration of Conformity	4	8.5	Uniform Heating	21
5	Description of the Unit	4	8.6	Reduction in Consumption during Night Hours (SLEEP Function)	21
5.1	Remote Controller	4	8.7	Reduction in Consumption with programmed Operating Time (TIMER Function)	21
5.2	Technical Specifications	5	8.8	Appropriate Maintenance of the Unit	21
6	Initial Settings	6	9	Troubleshooting	22
6.1	Fitting the Remote Controller Batteries	6	10	Maintenance	23
6.2	Clock Settings	6	10.1	Cleaning the Remote Controller	23
7	Operating Instructions	7	10.2	Cleaning the Indoor Unit	23
7.1	General Safety Considerations during Use	7	10.3	Cleaning the Air Filters	23
7.2	Identification of Functions	8	10.4	Cleaning the Outdoor Unit	23
7.2.1	Remote Controller Buttons	8	11	Storage over a prolonged Period	24
7.2.2	Display Indicators	8	12	Product Decommissioning	24
7.3	Advice on how to use the Remote Controller	9			
7.3.1	Remote Controller Lock	9			
7.4	Connection/Disconnection of the Unit	9			
7.5	Selection of the Operation Mode	9			
7.5.1	Automatic Mode (AUTO)	9			
7.5.2	Cooling Mode (COOL)	10			
7.5.3	Dehumidifying Mode (DRY)	11			
7.5.4	Fan Mode (FAN)	12			
7.5.5	Heating Mode (HEAT)	13			
7.6	Setting the Airflow Direction	14			
7.6.1	Vertical Airflow	14			
7.6.2	Horizontal Airflow	15			
7.7	Special Function Selection	15			
7.7.1	Health Anion Operation (HEALTH)	15			
7.7.2	Health Airflow Operation (HEALTH FLOW)	16			
7.7.3	SLEEP Function	17			
7.7.4	TIMER ON/OFF Function (CONNECTION/ DISCONNECTION USING TIMER)	18			
7.7.5	POWER/SOFT Function	19			
7.8	Emergency Operation and Operation Test	20			
7.8.1	Emergency Operation	20			
7.8.2	Operation Test	20			
7.8.3	Cancellation of Emergency Operation/ Emergency Test	20			

1 Your Safety

1.1 Symbols used



Danger!
Direct danger for life and health.



Danger!
Danger of electric shock.



Warning!
Potentially dangerous situation for the product and the environment



Note!
Useful information and indications.

1.2 Proper Use of the Unit

This unit has been designed and manufactured for acclimatisation purposes by means of air conditioning. The use thereof for other domestic or industrial purposes shall be the exclusive responsibility of the persons projecting, installing or using them in that way.

Prior to handling, installing, starting up, using or performing maintenance on the unit, the persons assigned to perform these tasks should be familiar with all the instructions and recommendations set forth in the unit's installation manual and in the user manual.

Vaillant does not accept any responsibility for damages that may arise from non-observation of the following instructions.



Note!
The installation of the unit has to be done by qualified people. Do not install it yourself. All electrical repairs should be also carried out by qualified electricians



Note!
Please read this User Manual carefully before using the air conditioning.



Note!
Keep the manuals throughout the service life of the unit.



Note!
The information relating to this unit is divided between two manuals: installation manual and user manual.

2 Extreme Operating Conditions

This unit has been designed to operate within the range of temperatures indicated on Figure 2.1. Ensure that these ranges are not exceeded.

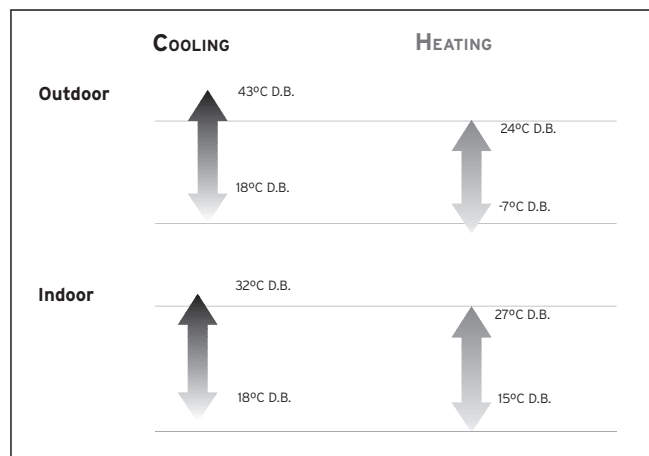

Fig. 2.1 Operating ranges of the unit.

Legend

D.B. Temperature measured by dry bulb

3 Identification of the Unit

4 Declaration of Conformity

5 Description of the Unit

3 Identification of the Unit

This manual is valid for the Split Type series. In order to know the specific model of your unit please refer to the unit nameplates.

The nameplates are located on the outdoor and indoor units.

4 Declaration of Conformity

The manufacturer declares that this unit has been designed and constructed in compliance with the standard in force with regard to obtaining the CE Marking.

5 Description of the Unit

This unit is comprised of the following elements:

- Outdoor unit.
- Indoor unit.
- Remote controller and holder.
- Connections and channels.
- Accessories.

Figure 5.1 shows the unit components.

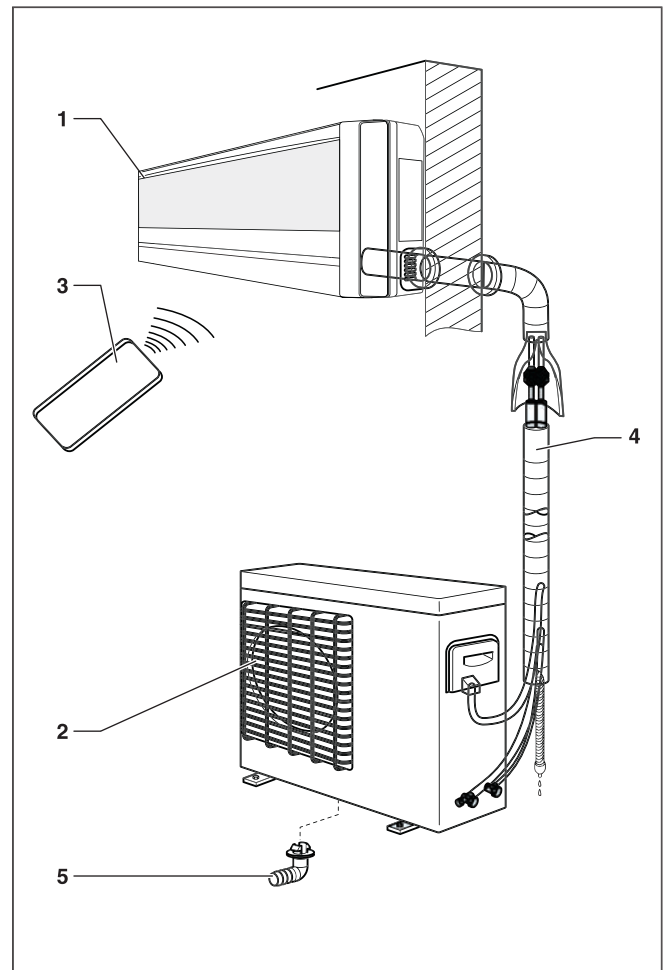

Fig. 5.1 Unit components.

Legend

- 1 Indoor Unit
- 2 Outdoor unit
- 3 Remote controller and holder
- 4 Connections and channels
- 5 Condensed water drainage pipe

5.1 Remote Controller

The remote controller allows using the unit.

5.2 Technical Specifications













TECHNICAL SPECIFICATIONS	PICTORIAL SYMBOL	DESCRIPTION
Heat pump		The equipment is reversible. It allows cooling or heating the rooms as desired.
Refrigerant R-410A		Refrigerant free of chlorine, ecological and environmentally friendly with a transfer capacity greater than R 407 C or than R22, providing far better COP levels.
Inverter DC technology		Energy saving greater than conventional inverter systems.
Inverter technology		Consumption is adapted to the acclimatization requirement in a regulated way, guaranteeing very low energy costs. The equipment can be operated under extreme temperature conditions.
Activated carbon filter		It analyses and purifies harmful gases, eliminating strange odours and maintaining a fresh atmosphere. This filter's exposure to sunlight regenerates its anti-odour capacity.
Anti-bacterial filter		Filter with an anti-allergic and anti-bacterial effect which keeps the atmosphere clean and healthy.
Anti-dust filter		Anti-dust filter.
Remote controller		Remote controller using infrareds.
Hot start function		Start and stop with hot battery which avoids the discharge of cold air.
Auto restart function		After a voltage cut-off the unit's automatic restart function is guaranteed under the conditions established before the cut-off.
Valve protection		This protects the outdoor unit's faucets from bad weather.
Anti-freeze		This prevents the freezing of the outdoor unit during the winter months.
Anti-corrosion casing		Outdoor unit made of galvanized steel and anti-corrosion materials. Resistant even in highly saline environments.

Table 5.1 Technical Specifications.

6 Initial Settings

6.1 Fitting the Remote Controller Batteries

Insert two batteries R-03 (7#), as described below (see Figure 6.1).

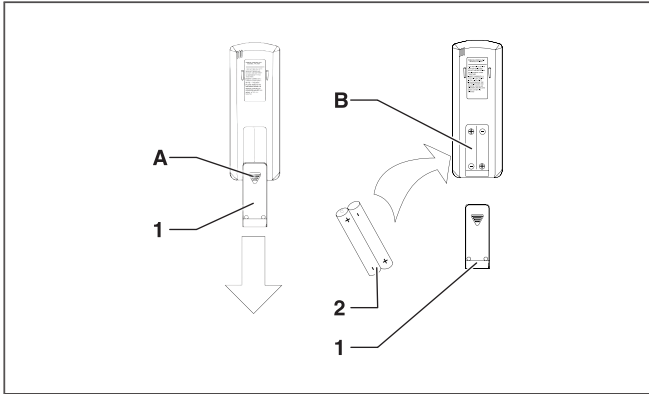

Fig. 6.1 Fitting the remote controller batteries.

Legend

- 1 Battery lid
- 2 Batteries
- A Pressure area for opening the lid
- B Battery compartment

- Remove the battery lid by pressing gently on zone A and pushing the lid downwards.
- Insert the batteries in the remote control ensuring correct positive and negative polarity (Shown on the battery compartment).
- Put the lid back on.
- Press the ON/OFF button (see Figure 7.1) to check that the batteries are correctly inserted.



Note!

If nothing appears on the display after pressing ON/OFF, reposition the batteries. Always replace the two batteries at the same time.



Note!

If the remote controller does not run properly during operation, please remove the batteries and reposition a few minutes later. Remove the batteries in case the air conditioning is out of use for a long period. If there is anything still showing on display, just press the reset button. Remove the batteries in case the air conditioning is out of use for a long period. If there is anything still showing on display, just press the reset button.



Warning!

Danger of the environmental contamination by not disposing of the batteries properly. When replacing the remote controller batteries, leave the old batteries in suitable containers. Never throw away in the rubbish.

6.2 Clock Settings

Use the remote controller to adjust the unit clock the first time the unit is started or after replacing the batteries, see Figure 6.2.

- Press the CLOCK button. The "AM" or "PM" indicators start to flash on the remote controller display.
- Press the UP / DOWN buttons to set the desired time: When pressing the UP / DOWN buttons, the time configuration will increase or decrease by 1 minute. If the UP / DOWN buttons are kept pressed, the time will increase or decrease rapidly.
- Press the SET button to confirm the time setting. The "AM" or "PM" indicators will stop flashing and the clock will start to operate.

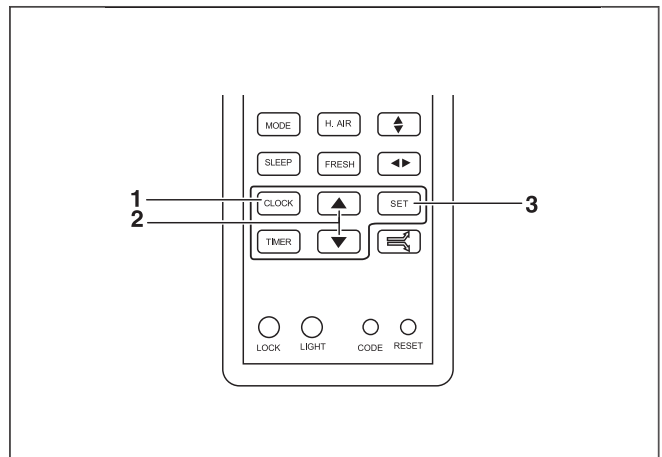

Fig. 6.2 Clock Settings.

Legend

- 1 CLOCK button
- 2 UP / DOWN buttons (increase/decrease)
- 3 SET button

7 Operating Instructions

7.1 General Safety Considerations during Use



Danger of injury and physical damage!

- Do not let children play with the air conditioning unit. The unit is not designed for use by children or infirm persons without supervision. Children should not sit on the outdoor unit under no circumstances.
- Do not put any objects on top of the unit.
- Do not connect the equipment whilst using insecticides or pesticides. These could settle in the unit and harm the health of persons with allergies to specific chemical substances.
- Avoid prolonged exposure to cooled air or extreme temperatures in the room and do not direct the air flow at people, especially infants, infirm people or old people.
- Do not use this unit to preserve food, art work, precision equipment, plants or animals.
- Do not cover the ventilation grille and do not insert your fingers or other objects in the air inlets and outlets, or between the unit slats whilst the unit is operating. The high speed of the fan can cause injuries.
- Always remember to unplug the unit before opening the Inlet grille. Never unplug the unit by pulling the power cord.
- Do not leave the power supply cord in a bundle and take care not to damage the power supply cord. After installation the power plug should be easily reached.
- Do not damage any parts of the unit containing refrigerant by piercing the air conditioning's tubes with sharp or pointed items, by crushing or twisting any tube or by scraping the coating off the surface. If the refrigerant spurts out and gets into your eyes it may result in serious eye injuries.
- Do not interrupt the operation of the air conditioning unit by pulling the cord.



Danger of injury and physical damage!

Danger of fire and explosion.

- Damaged air conditioners should not be put into operation. In case of doubt, consult your supplier.
- The air conditioner must be properly grounded in accordance with specifications.
- Do not place any heat source with flame in the equipment airflow. Do not use sprays or other flammable gases near the air equipment. This could cause a fire.
- In the event that any irregularity is detected (such as a burning smell), unplug the unit from the mains immediately and contact the distributor in order to proceed properly. If you continue to use the unit under these irregular conditions, it could be damaged and cause short circuiting or fire.
- If the power supply is damaged, make sure it is replaced by the manufacturer or its service agent or a qualified person.
- If the fuse of the Indoor unit is broken, please change it with type T.3.15A/ 250V. If the fuse of the Outdoor unit is broken, change it with type T.25A/250V.
- The wiring should be done according to the local wiring standards.
- In order to protect the unit, please turn off the A/C first and at least 30 seconds later, cutting off the power.
- Phone a specialist technician and ensure that preventive measures are implemented to avoid refrigerant gas leaks. Leaking refrigerant of a certain density can cause oxygen deficiency



Danger!

Danger of electric shock.

- Do not handle the equipment with wet or moist hands.



Warning!

Danger of breakdowns or malfunction.

- Do not place any object on the outdoor unit.

7 Operating Instructions

7.2 Identification of Functions

7.2.1 Remote Controller Buttons

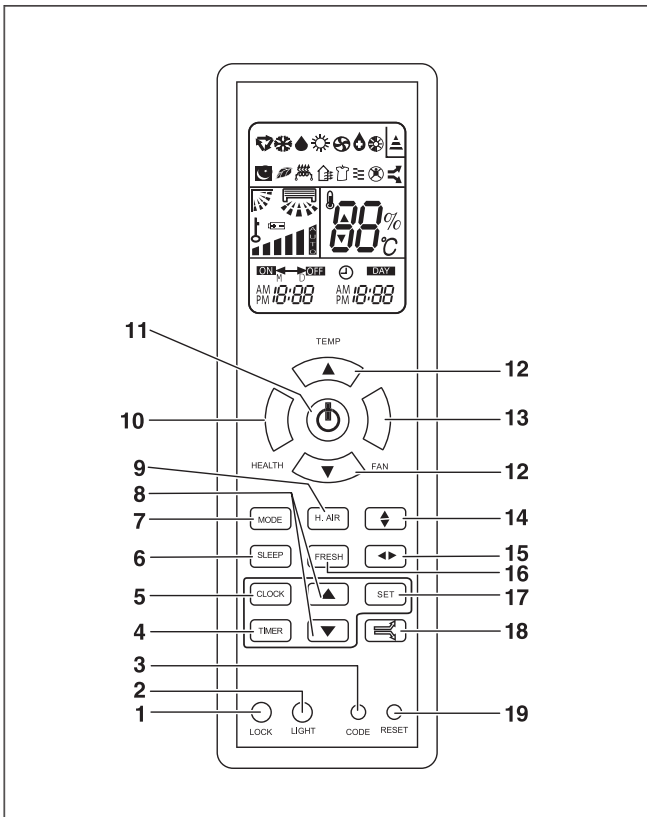

Fig. 7.1 Overview of the buttons.

Legend

- 1 LOCK button
- 2 LIGHT button, only for the model with the background light function
- 3 CODE button
- 4 TIMER button
- 5 CLOCK button
- 6 SLEEP button (NIGHTTIME FUNCTION)
- 7 MODE button
- 8 HOUR button
- 9 HEALTH AIRFLOW button (IONIZED AIRFLOW)
- 10 HEALTH button (IONIZER)
- 11 ON/OFF button
- 12 TEMP button (TEMPERATURE)
- 13 FAN button
- 14 SWING UP/DOWN button (AIRFLOW DIRECTION UP/DOWN)
- 15 SWING LEFT/RIGHT button (AIRFLOW DIRECTION LEFT/RIGHT)
- 16 FRESH button
- 17 SET button (SETTING)
- 18 POWER/SOFT button
- 19 RESET button

7.2.2 Display Indicators

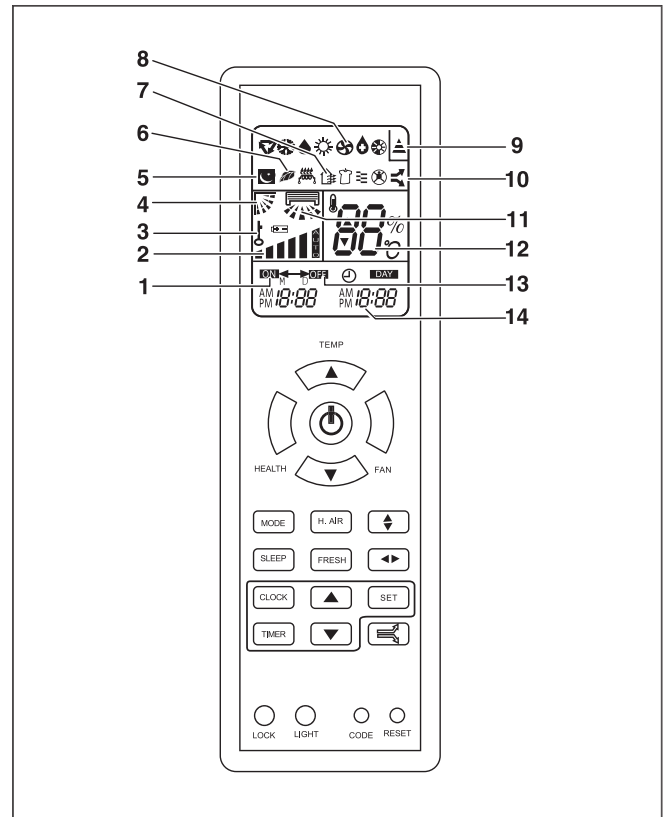

Fig. 7.2 Overview of the indicators.

Legend

- 1 TIMER ON indicator
- 2 FAN SPEED indicator
- 3 LOCK indicator
- 4 SWING UP/DOWN indicator (AIRFLOW DIRECTION UP/DOWN)
- 5 SLEEP indicator (NIGHTTIME FUNCTION)
- 6 HEALTH indicator (IONIZER)
- 7 FRESH AIR indicator
- 8 CODE indicator
- 9 SIGNAL SENDING indicator
- 10 POWER/SOFT indicator
- 11 AIR FLOW LEFT/RIGHT indicator
- 12 TEMP indicator (TEMPERATURE)
- 13 TIMER OFF indicator (DISCONNECTION USING TIMER)
- 14 CLOCK indicator

7.3 Advice on how to use the Remote Controller

Follow the recommendations below as to how to use the remote controller:

- When in use, direct the head of the signal transmitter directly to the indoor unit receiver.
- Keep the distance between the transmitter and the receiver within 7 m.
- Avoid obstacles between the transmitter and the receiver.
- Reduce the distance between the remote controller and the indoor unit in locations with fluorescent lights with electronic switching on or cordless telephones.
- Do not drop, throw or strike the remote controller.

7.3.1 Remote Controller Lock

In order to lock the buttons and display of the remote controller device:

- Press the LOCK button.
The rest of the buttons are deactivated.
The lock status indicator appears.

In order to deactivate the lock:

- Press the LOCK button again.
The rest of the buttons are activated.
The lock status indicator disappears.

Note!

If the remote controller does not operate correctly, press the RESET button with a sharp object to reset the remote controller.

7.4 Connection/Disconnection of the Unit

In order to connect the unit:

- Press the ON button on the indoor unit or on the remote controller; the unit will start to operate.
The liquid crystal display (LCD) will show the latest operating status of the unit (except the HEALTH, SLEEP, POWER/SOFT and TIMER ON/OFF functions).

In order to disconnect the unit:

- Press the OFF button on the indoor unit or on the remote controller; the unit will stop:

7.5 Selection of the Operation Mode

7.5.1 Automatic Mode (AUTO)

In automatic mode (AUTO) the air conditioning unit automatically selects the cooling (COOL) or heating (HEAT) mode in accordance with the actual ambient temperature.

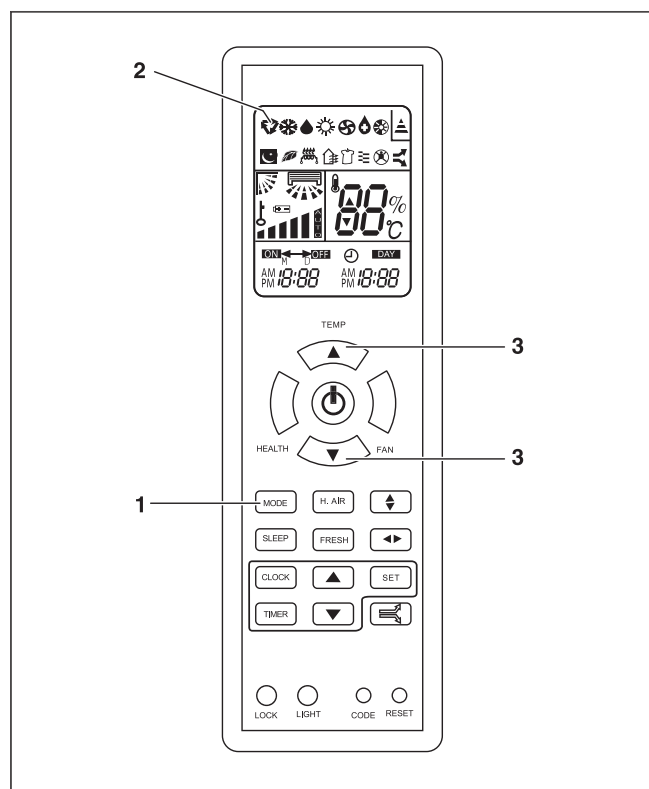

Fig. 7.3 Automatic mode selection.

Legend

- 1 MODE button
- 2 AUTO mode indicator
- 3 TEMP button (increase/decrease)

In order to activate:

With the unit connected (see section 7.4):

- Press the MODE button.
The different operation modes are displayed.



Fig. 7.4 Operation modes.

- Select the automatic operation mode (AUTO).
- Press the TEMP buttons to select the temperature setting.
When pressing the TEMP buttons, the temperature configuration will increase or decrease by 1°C.
When keeping the TEMP buttons pressed, the temperature configuration will increase or decrease quickly.

7 Operating Instructions

7.5.2 Cooling Mode (COOL)

In cooling mode (COOL), the air conditioning unit only allows cooling.

Note!
In cooling mode it is recommendable to direct the grates horizontally.

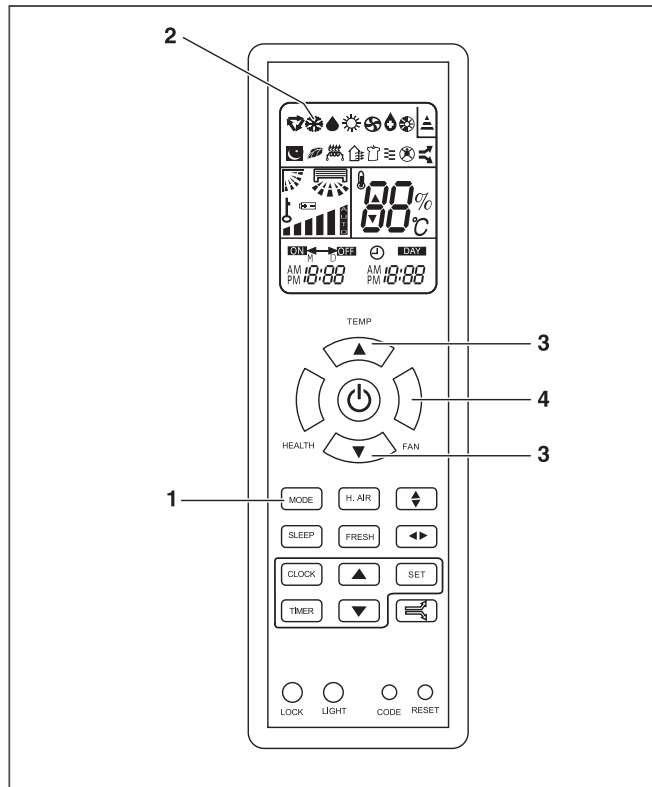

Fig. 7.5 Cooling mode selection.

Legend

- 1 MODE button
- 2 COOL mode indicator
- 3 TEMP button (increase/decrease)
- 4 FAN button

In order to activate:

With the unit connected (see section 7.4):

- Press the MODE button.
The different operation modes are displayed.



Fig. 7.6 Operation modes.

- Select the cooling operation mode (COOL).
- Press the TEMP buttons to select the temperature setting.
When pressing the TEMP buttons, the temperature configuration will increase or decrease by 1°C. When keeping the TEMP buttons pressed, the temperature configuration will increase or decrease quickly.
- Press the FAN button to select the fan speed.
Each time the FAN button is pressed, the fan speed will be modified as shown in Figure 7.7.



Fig. 7.7 Fan speed.

When the fan is configured in AUTO mode, the air conditioning unit automatically sets the fan speed in accordance with the actual ambient temperature.

Note!
In cooling mode, prolonged use of the unit under conditions of considerable air humidity can cause drops of water to fall on the outlet grate.

7.5.3 Dehumidifying Mode (DRY)

In dehumidifying mode (DRY), the air conditioning unit operates by removing the humidity from the atmosphere.

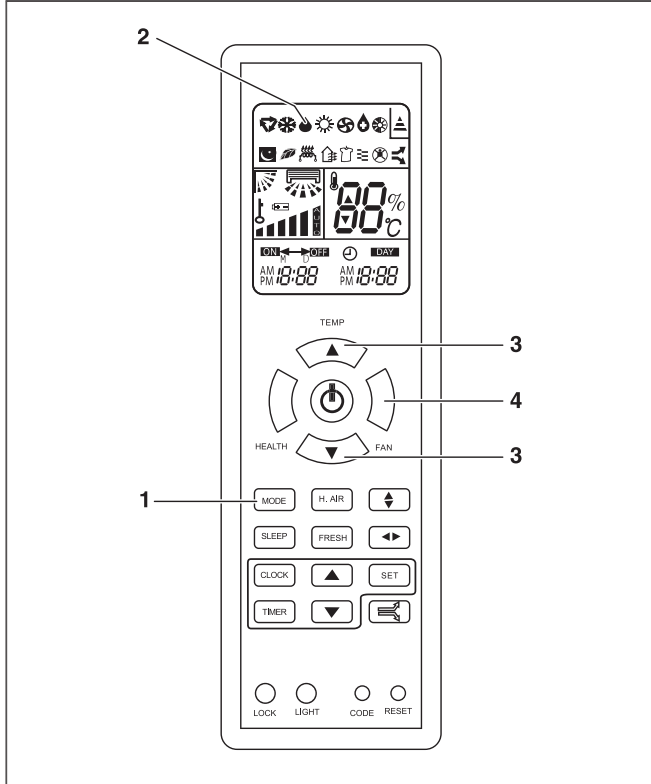

Fig. 7.8 Dehumidifying mode selection.

Legend

- 1 MODE button
- 2 DRY mode indicator
- 3 TEMP button (increase/decrease)
- 4 FAN button

In order to activate:

With the unit connected (see section 7.4):

- Press the MODE button.
The different operation modes are displayed.



Fig. 7.9 Operation modes.

- Select the dehumidifying mode (DRY).
- Press the TEMP buttons to select the temperature setting.
When pressing the TEMP buttons, the temperature configuration will increase or decrease by 1°C. When keeping the TEMP buttons pressed, the temperature configuration will increase or decrease quickly.
- Press the FAN button to select the fan speed.
Each time the FAN button is pressed, the fan speed will be modified as shown in Figure 7.10.



Fig. 7.10 Fan speed.

The operation in cooling mode is started when the ambient temperature is greater than the configured one. In dehumidifying mode and, when the ambient temperature exceeds the configured one by 2°C, the unit will operate intermittently at LOW speed regardless of the fan configuration, see Figure 7.11.

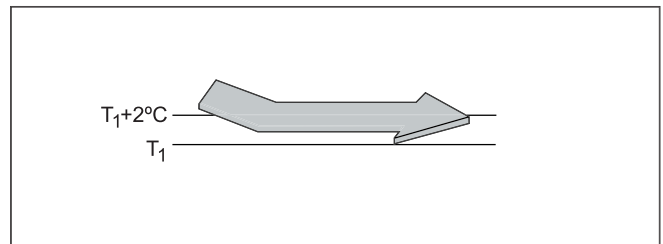

Fig. 7.11 Dehumidifying mode working diagram.

Legend

T₁ Configured temperature



Note!

In dehumidifying mode, prolonged use of the unit under conditions of considerable air humidity can cause drops of water to fall on the outlet grate.

7 Operating Instructions

7.5.4 Fan Mode (FAN)

In fan mode (FAN) the unit does not operate in the following modes:

- cooling mode (COOL).
- heating mode (HEAT).
- automatic mode (AUTO).

In fan mode (FAN) the temperature configuration and the SLEEP function are disabled.

- Select the fan operation mode (FAN).
- Press the FAN button to select the fan speed. Each time the FAN button is pressed, the fan speed will be modified as shown in Figure 7.14.



Fig. 7.14 Fan speed.

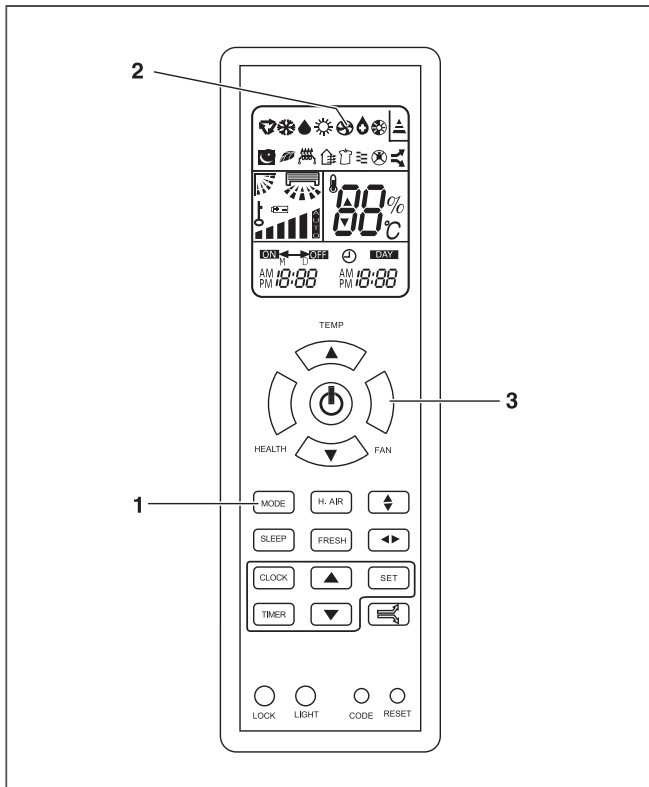

Fig. 7.12 Fan selection mode.

Legend

- 1 MODE button
- 2 FAN mode indicator
- 3 FAN button

In order to activate the fan mode (FAN):
With the unit connected (see section 7.4):

- Press the MODE button.
The different operation modes are displayed.



Fig. 7.13 Operation modes.

7.5.5 Heating Mode (HEAT)

In heating mode, the air conditioning only allows heating.

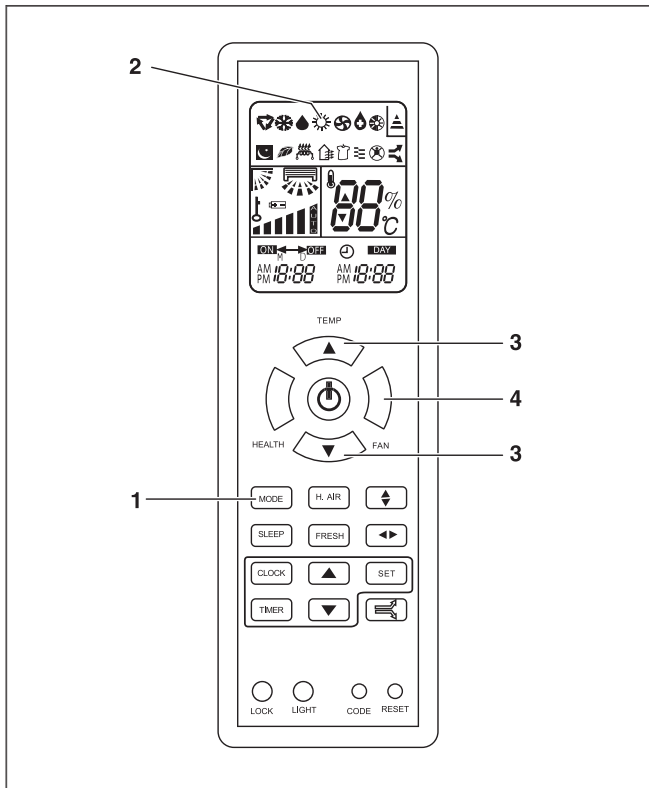

Fig. 7.15 Heating mode selection.

Legend

- 1 MODE button
- 2 HEAT mode indicator
- 3 TEMP button (increase/decrease)
- 4 FAN button

In order to activate:

With the unit connected (see section 7.4):

- Press the MODE button.
The different operation modes are displayed.



Fig. 7.16 Operation modes.

- Select the heating operation mode (HEAT).
- Press the TEMP buttons to select the temperature setting.
When pressing the TEMP buttons, the temperature configuration will increase or decrease by 1°C. When keeping the TEMP buttons pressed, the configured temperature will increase or decrease quickly.
- Press the FAN button to select the fan speed.
Each time the FAN button is pressed, the fan speed will be modified as shown in Figure 7.17.

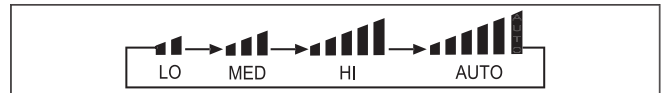

Fig. 7.17 Fan speed



Note!

In heating mode (HEAT), the hot air will stop after a short period of time as a result of the function for the prevention of cold currents.

7 Operating Instructions

7.6 Setting the direction of the airflow

The direction of the airflow can be set in vertical and horizontal directions.



Danger of injury and physical damage!
Avoid direct body contact with the powerful airflows. Do not expose animals and plants directly to the airflow. They could suffer damage.



Warning!
 Danger of breakdowns or malfunction.
 Do not open the outlet grate manually.



Note!
 If the grate does not work correctly, stop the unit for one minute and restart it carrying out the settings required with the remote controller.



Note!
 In heating mode it is recommendable to direct the grates vertically.



Note!
 In cooling mode it is recommendable to direct the grates horizontally.

7.6.1 Vertical Airflow

• Press the SWING UP/DOWN button to direct the airflow upwards or downwards.

The vertical slat will be directed in accordance with the positions allowed for each operation mode. On the remote controller or the control panel of the indoor unit the different icons will be shown in accordance with the operation mode, see Table 7.1.

- COOL/DRY/FAN modes:
 Permitted positions: 1, 2, 3, 4, 6
- HEAT mode:
 Permitted positions: 1, 2, 3, 4, 5, 6
- AUTO mode:
 Permitted positions: 1, 2, 3, 4, 5, 6

Vertical Direction	
Position 1	
Position 2	
Position 3	
Position 4	
Position 5	
Position 6 (Automatic direction)	

Table 7.1 Vertical direction positions.

7.6.2 Horizontal Airflow

- Press the SWING LEFT/RIGHT button to direct the airflow to the left or right. The horizontal deflectors are directed in accordance with the indicated positions. On the remote controller or the control panel of the indoor unit the different icons will be shown, see Table 7.2.

Horizontal Direction	
Position 1	
Position 2	
Position 3	
Position 4	
Position 5	
Position 6	
Position 7	
Position 8	

Table 7.2 Horizontal direction positions.

Note!
When stopping the unit, the remote controller will memorise the configured direction position, remembering this the next time it is put into operation.

7.7 Special Function Selection

7.7.1 Health Anion Operation (HEALTH)

- The anion generator of the air conditioning unit has the following functions:
- To generate anions to neutralise the quantity of cations and anions in the air.
 - To kill bacteria.
 - To accelerate the sedimentation of dust in the room to clean the room air.
- UV light degerming function:
- UV light emitted by the UV light device of the indoor unit catalitically activates the nano TiO₂ on the multi-lights touching intermediary, and the degerming effect is highly efficient and lasting.

Note!
Do not open the inlet grille when the degerming function is activated.

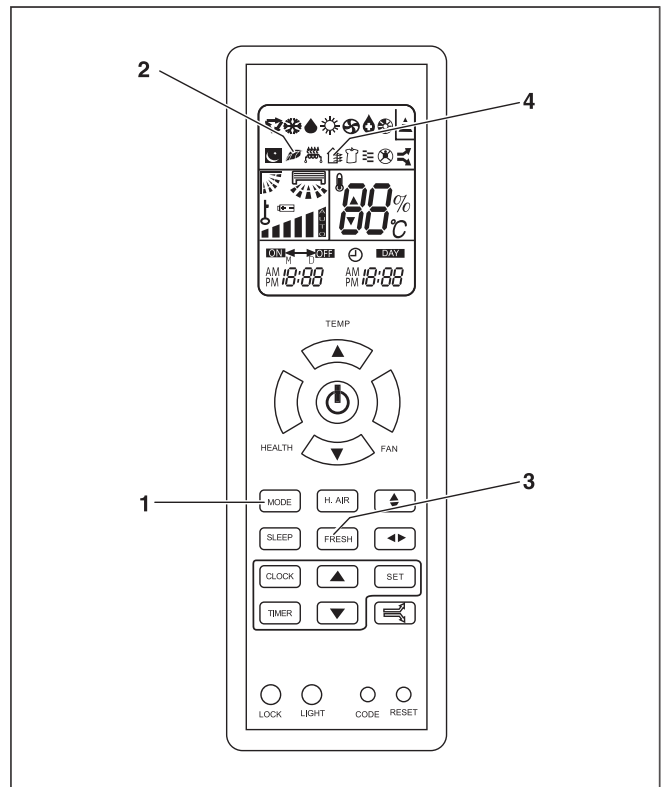

Fig. 7.18 HEALTH function selection.

- Legend**
- 1 HEALTH button
 - 2 HEALTH function indicator
 - 3 FRESH AIR button
 - 4 FRESH AIR indicator

- To activate the health anion function:
- Press the HEALTH button
- To cancel the function:
- Press the HEALTH button again to stop the health anion operation.

7 Operating Instructions

Fresh Air function (optional):

- The outdoor air can enter indoors through the fresh air tube, keeping the indoor air fresh.
- To change from health function to fresh air function, press the FRESH button (fresh air indicator will appear on the display).
- To cancel the health function press the FRESH button again.



Note!

The HEALTH indicator will light when the indoor unit fan does not function even if the anion generator is not operating.

7.7.2 Health Airflow Operation (HEALTH FLOW)

The direction of the ionised airflow can be set in vertical and horizontal directions.

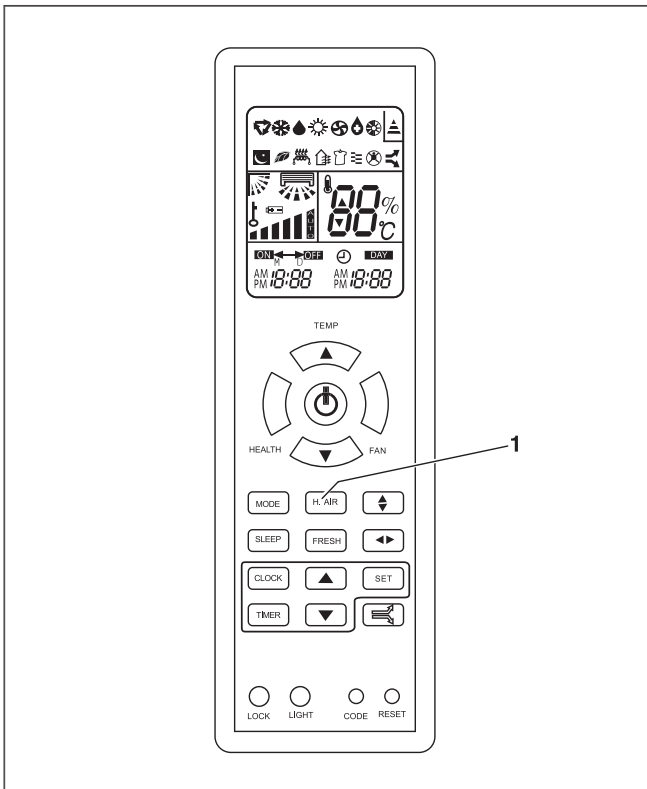

Fig. 7.19 HEALTH FLOW function selection.

Legend

1 HEALTH FLOW button

In order to activate:

- Press the HEALTH FLOW button to direct horizontally. The horizontal flow indicator will appear on the display. The unit's bottom inlet and outlet grates will close and the airflow will circulate horizontally from the top inlet and outlet grates.
- Press the HEALTH FLOW button again to direct vertically. The vertical flow indicator will appear on the display. The unit's top inlet and outlet grates will close and the airflow will circulate vertically from the bottom inlet and outlet grates.
- Press the HEALTH FLOW button again to cancel the health airflow function. Both the inlet and outlet grates will remain open operating in the mode in which the unit was configured before activating the health airflow function.



Note!

After configuring the health airflow function, the inlet and outlet grates will be fixed. Select the adequate fan direction according to the real conditions.



Note!

In cooling and dehumidifying mode, prolonged use of the unit under conditions of considerable air humidity can cause drops of water to fall on the outlet grate.



Note!

In HEAT mode it is better to select the vertical flow direction
In COOL mode it is better to select the horizontal flow direction.

7.7.3 SLEEP function

The COOL, DRY, HEAT modes can be set during the nighttime hours to avoid an excessive increase or decrease in the temperature.

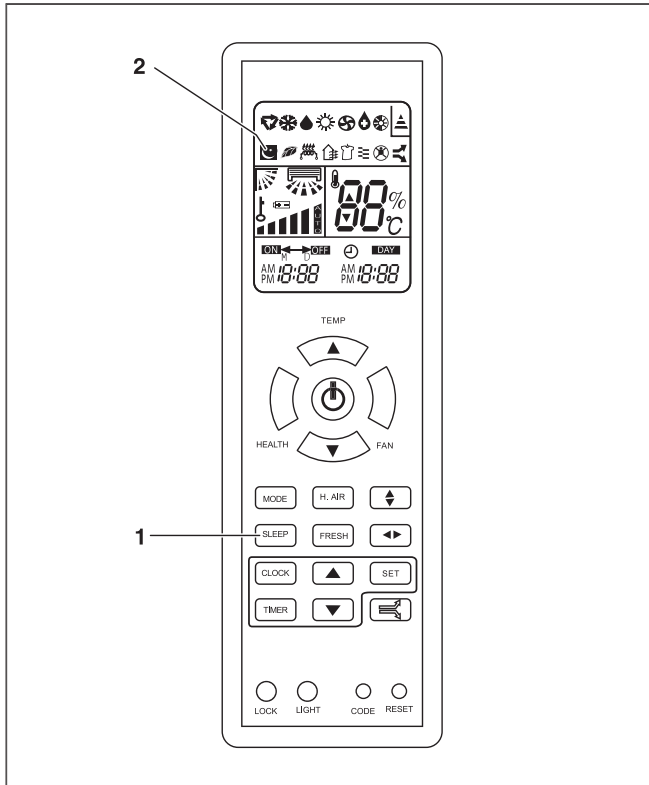

Fig. 7.20 Selection of SLEEP function.

Legend

- 1 SLEEP button
- 2 SLEEP function indicator

In order to activate:

- Select the desired operation mode (see section 7.5).
- Press the SLEEP button.

In COOL, DRY mode

The ambient temperature increases 2°C in relation to the configured one to ensure that the temperature does not drop excessively during sleeping hours.

- During the first operating hour of the SLEEP function, the ambient temperature will rise 1°C above the configured temperature.
- Once an hour has elapsed, the temperature will rise 1°C more.
- The unit is operational for 6 hours before stopping.

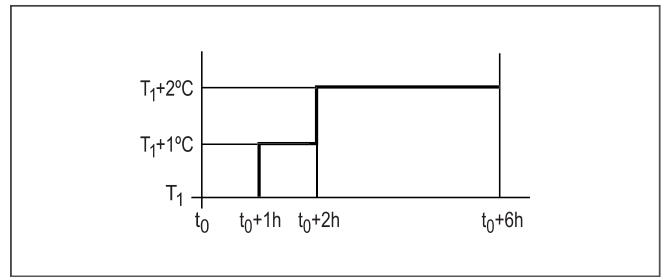

Fig. 7.21 Working method of the SLEEP function in COOL, DRY mode.

Legend

- T₁ Configured temperature
- t₀ Start of the SLEEP function

In HEAT mode

The ambient temperature decreases 2°C in relation to the configured one to ensure that the temperature does not rise excessively during the sleep hours.

- During the first operating hour of the SLEEP function, the ambient temperature will drop 2°C below the configured temperature.
- Once an hour has elapsed, the temperature will drop 2°C more.
- Once three hours have elapsed, the temperature will rise 1°C.
- The unit will be operational for a further three hours before stopping.

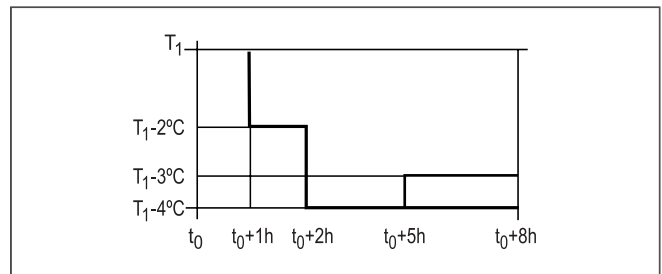

Fig. 7.22 Working method of the SLEEP function in HEAT mode.

Legend

- T₁ Configured temperature
- t₀ Start of the SLEEP function

In AUTO mode

The unit operates in the operating mode selected automatically adapted to the corresponding SLEEP modality.

In FAN mode

The unit does not have SLEEP function.



Note!

Set the wind speed change when sleeping. If the wind speed is high or medium, set the unit to reduce to low wind. If the unit is set to low wind, do not change de setting.

7 Operating Instructions

7.7.4 TIMER ON/OFF Function (CONNECTION/ DISCONNECTION USING TIMER)

The unit can be connected/disconnected using the timer.

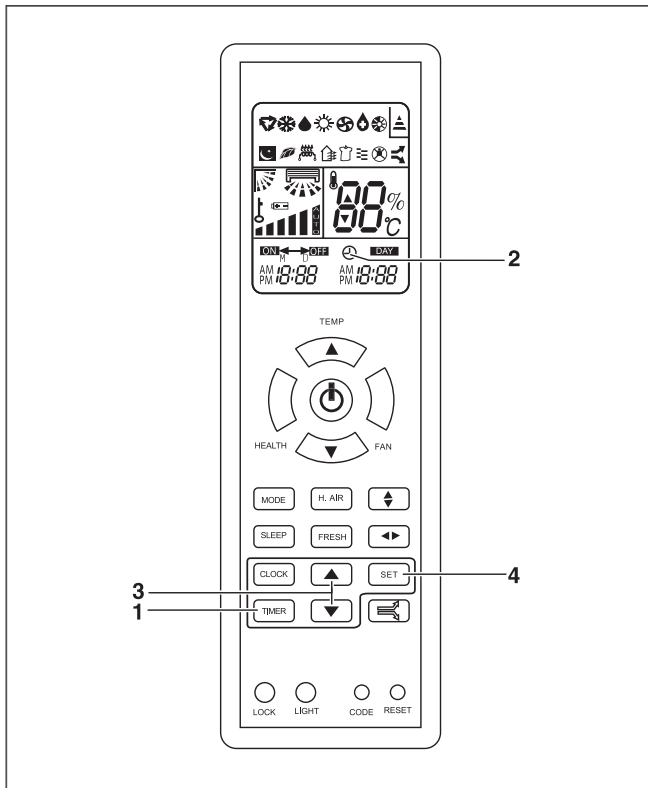

Fig. 7.23 Selection of TIMER function.

Legend

- 1 TIMER button
- 2 TIMER ON/OFF function indicator
- 3 HOUR buttons (increase/decrease)
- 4 SET button

In order to activate:

- Select the desired operation mode (see section 7.5).
- Press the TIMER button.
The display configuration of the remote controller will change.
Each time it is pressed, the timer modality will change
Timer ON/Timer OFF.
The "ON"/"OFF" indicators will light.



Fig. 7.24 Remote controller display configuration.

- Press the HOUR buttons to programme the desired time:
When pressing the HOUR buttons, the time configuration will increase or decrease by 1 minute. If the HOUR buttons are kept pressed, the time will increase or decrease rapidly.
The time can be set within an interval of 24 hours.
 - Press the SET button to confirm the time.
The "ON" or "OFF" indicators will stop flashing.
Time display: the unit starts to operate or stops after x hours x minutes.
- In order to cancel:
- Press the TIMER button various times until the TIMER ON/OFF function display configuration disappears.

Note!
Correctly set the clock before operating the timer.

Note!
Restart the time configuration after replacing the batteries or after a possible power failure.

Note!
The unit has a memory function; when you use the TIMER ON/OFF function the next time, press the SET button if the timer configuration is identical to that used the last time.

7.7.5 POWER/SOFT Function

Use the POWER function when you need fast heating or cooling.
The SOFT function will reduce the noise level of the unit.

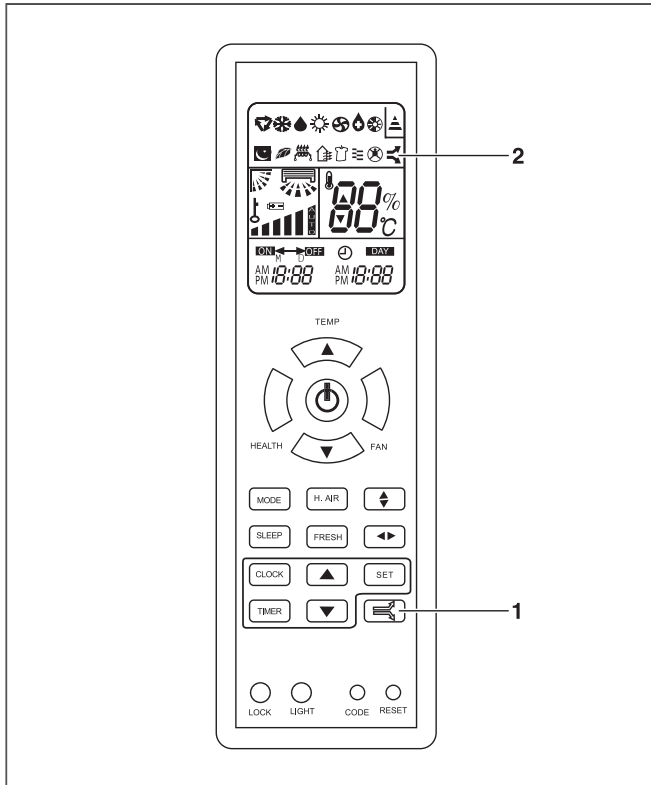

Fig. 7.25 POWER/SOFT function selection.

Legend

- 1 POWER/SOFT button
- 2 POWER/SOFT function indicator

To activate the POWER function:

- Press the POWER/SOFT button.
Each time you press the button, you will modify the display configuration, see Figure 7.26.



Fig. 7.26 POWER/SOFT function display configuration.

- Stop the display in POWER function.
In HEAT or COOL mode the fan speed is available automatically in HI (high) for 15 minutes in order to put the configuration back to its original state.
- To cancel the POWER function:
 - Press the POWER/SOFT button twice.
The indicator will disappear.
- To activate the SOFT function:
 - Press the POWER/SOFT button.
Each time you press the button, you will modify the display configuration, see Figure 7.26.
- Stop the display in SOFT function.
In SOFT function the fan speed is automatically available in LO (low).
- To cancel the SOFT function:
 - Press the POWER/SOFT button twice.
The indicator will disappear.

 **Note!**
In POWER function in HEAT and COOL mode, the room will show an even thermal distribution.

 **Note!**
Prolonged operation in SOFT function will cause irregularities in the atmosphere, the temperature not being too cold or too hot.

7 Operating Instructions

7.8 Emergency Operation and Operation Test

7.8.1 Emergency Operation

Only use this function when the remote controller is broken or has been mislaid. In emergency operation the unit automatically selects the operation modes, Cooling or Heating depending on the ambient temperature, see Table 7.3.

Temperature	Operation Mode	Desired Temp.	Timer Mode	Airflow
> 23°C	Cooling	26°C	No	Auto
< 23°C	Heating	23°C	No	Auto

Tab. 7.3 Emergency Operation.

In order to activate:

- Press the emergency operation/operation test switch. A beeping noise is heard which indicates that the function has been put into operation.

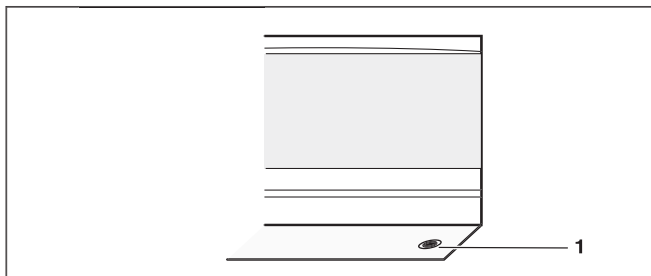

Fig 7.30 Emergency operation/operation test switch.

Legend

1 Emergency operation/operation test switch



Note!

When in emergency operation the dehumidifying mode is not available.

7.8.2 Operation Test

Only use this function to carry out operation tests when the temperature is less than 16°C.

In order to activate:

- Lift the front lid of the indoor unit.
- Keep the emergency operation/operation test switch pressed for more than five seconds. A beep is heard twice which indicates the start of the function in cooling mode with the HI (high) airflow speed.
- Release the switch. After 30 minutes the function test will end automatically.

7.8.3 Cancellation of Emergency Operation/ Emergency Test

- Press the emergency operation/operation test switch once again or use the remote controller. The beeping stops. The unit returns to normal operating mode.

8 Advice for saving Energy

8.1 Suitable ambient Temperature

Set the ambient temperature to an appropriate value to guarantee physical wellbeing, comfort and, in any case, to comply with the legal standard. Each degree above this value significantly increases the energetic consumption.

The temperature must also be suitable for the specific use being made of the room: the temperature of empty rooms and bedrooms does not have to be the same as the main room.

8.2 Eliminating Heat or Cold Sources

In the event that there are any heat (in cooling mode) or cold (in heating mode) sources that could be eliminated please do so (e.g. a window or a door which are not properly closed). This will ensure that the unit consumes less energy.

8.3 Operation in Heating Mode (Heat Pump)

Your unit, when operating in heating mode, acts as a heat pump, i.e. it takes heat from the outside (via the outdoor unit) and releases it inside (via the indoor unit). Nevertheless, a conventional heating system produces heat purely by consuming energy. Therefore, heating a room using a heat pump is far more economic than using conventional heating (radiators, heaters, boilers, etc.).

8.4 Ambient Temperature when absent

During heating mode, an economic saving is made by keeping the ambient temperature at approx. 5°C lower than the normal temperature. A reduction which exceeds these 5° C does not provide any further energy savings since greater heating power is required for consecutive periods of operation in normal operating conditions. It is only worth reducing the temperature even further in the event of prolonged absences, e.g. during holidays. During winter protection against freezing must be guaranteed.

8.5 Uniform Heating

Often in a house only the one room is heated. In addition to the surfaces which delimit this area, i.e. the walls, doors, windows, ceiling and floor, the adjacent rooms are also heated uncontrollably: thermal energy is unintentionally lost. It is therefore impossible to adequately heat the room and an unpleasant feeling of cold is felt (the same occurs when leaving open doors which separate heated areas and unheated areas in a limited way).

This is false economy: the heating is on and, nevertheless, the ambient temperature is not pleasant. Greater comfort and a more reasonable operating mode are gained by heating all the rooms in a house uniformly, taking into account the use being made of each room (the temperature of empty rooms and bedrooms does not have to be the same as the main room).

8.6 Reduction in Consumption during Night Hours (SLEEP Function)

Your unit has a SLEEP function which allows the temperature to be modified automatically in relation to the predetermined values (in heating mode the temperature decreases slightly; in cooling mode the temperature increases slightly) during nighttime hours. Thus, apart from greater comfort being provided there is also a reduction in electric consumption. For more details regarding the SLEEP function, please consult section 7.7.1).

8.7 Reduction in Consumption with programmed Operating Time (TIMER Function)

By using the TIMER function you can adjust the operation start time of your unit. Therefore, it is possible to programme the operation of your unit to make it function only when required and thus achieve economic operation.

8.8 Appropriate Maintenance of the Unit

A unit in perfect condition operates efficiently, taking maximum advantage of the energy it consumes. Ensure that your unit is correctly serviced (for more details please consult section 10). In particular, make sure that the filters are kept clean and that the air inlets and outlets are not obstructed either on the indoor or outdoor unit.

9 Troubleshooting

9 Troubleshooting

The table below describes a series of problems with their possible causes and solutions, see Table 9.1. If these solutions do not solve the problem contact your usual installer or call your nearest SAT Vaillant service.

SYMPTOMS	POSSIBLE CAUSES	POSSIBLE SOLUTION
The system does not restart immediately	When unit is stopped, it won't restart until 3 minutes have elapsed to protect the system	Wait 3 minutes before starting the unit again
	When the electric plug is pulled out and inserted again, the protection circuit will work for three minutes to protect the air conditioner unit	Wait 3 minutes after inserting the plug and before starting the unit again
The system does not work at all (the ventilation does not start)	The power plug is not inserted	Insert the plug and start the unit by positioning the selector to "I" (start)
	Power supply cut	Reconnect the power supply
	The fuse has blown	Replace the fuse. Only use the right fuses for each model. Do not use wire or other material to replace the fuse. Fires could be caused
Insufficient cooling or heating	Doors and/or windows open	Close the doors and/or windows
	Heat source nearby (e.g. lots of people in the room)	If possible, remove the heat source
	The thermostat is set to an excessively high temperature in cooling mode or excessively low in heating mode	Set the temperature properly
	Obstacle in front of the air inlet or outlet	Remove the obstacle to allow the air to circulate properly
	The ambient temperature has not reached the designated level	Wait for a few moments
	Dirty or blocked air filter	Clean the air filter (the air filter should be cleaned every 15 days)
	Is there any direct sunlight through the window during the cooling operation?	Use a curtain to protect the air conditioning unit
Noise is heard	During unit operation or when stopping the unit a gurgling noise may be heard. This noise is more audible the first 2-3 minutes of operation	This is normal in an air conditioning unit. The noise is caused by the refrigerant flowing in the system).
	A cracking noise is heard during operation	This is normal in an air conditioning unit. The noise is caused by the casing expanding or shrinking due to the temperature changes
	If the noise is loud and comes from the air flow during the unit operation, the air filters may be too dirty	Clean the air filters properly
Smells are generated	This is because the system circulates smells from the indoor surrounding (furniture, cigarettes)	This situation does not require any action
Mist or steam come are blown out from the unit	During COOL mode or DRY mode operation, the indoor unit may blow some mist. This is due to the sudden cooling of the indoor air.	This situation does not require any action

Table 9.1 Troubleshooting.

10 Maintenance



Danger!
Danger of electric shock.
Disconnect the unit and the thermal magnetic switch before proceeding to carry out maintenance on the unit. This will prevent injuries.



Danger!
Danger of electric shock.
Do not clean the unit with water.



Warning!
 Danger of breakdowns or malfunction.
 Do not use gasoline, benzine, thinner or cleansers when cleaning the unit. It may damage the coating of the unit.



Warning!
 Hot water over 40°C may cause discoloring or deformation.

10.1 Cleaning the Remote Controller

- Wipe the controller with a dry cloth. Do not use water to clean the remote controller.
- Do not use glass cleaners or chemical cloths.

10.2 Cleaning the Indoor Unit

- Wipe the outer part of the unit with a soft and dry cloth.
- For difficult stains, use a neutral detergent diluted in water. Eliminate the excess of water from the cloth before wiping. Leave the unit clean from any detergent.

10.3 Cleaning the Air Filters

The air filter eliminates the dust absorbed from the room into the indoor unit.

If the filter becomes obstructed, the air conditioner's efficiency will be reduced, the compressor could be damaged and the indoor unit's battery could freeze up. Clean the air filter regularly to prevent this from happening. In order to do so:

- Remove the air filters by slightly pushing up the center tab until it is released from the stopper and remove the filter downwards.
- Clean the filter removing the dust or the dirt using a vacuum cleaner or cleaning them with cold water.
- Ensure that the filters are dried completely (dry in the shade) before putting them back into the unit.
- Attach the filter correctly and make sure it is completely fixed behind the stopper. If the right and left filters are not properly fixed, this could cause a malfunction.



Warning!
 Danger of breakdowns or malfunction.
 Do not attach perfume systems, anti-odour systems etc. in the filter or in the inside air return.

This can damage and soil the evaporation battery. If necessary, install these systems at the unit's outlet point and ensure they only run when the fan is on.

10.4 Cleaning the Outdoor Unit

- Wipe the outer part of the unit with a dry cloth.
- Occasionally remove dust from the inlet surface.
- Periodically clean the capacitor battery with a soft brush when the unit is located in a dusty environment.
- Occasionally check the base of the outdoor unit.



Danger of injury and physical damage!
A damaged or deteriorated base could make the unit fall down and cause physical or material damage.



Danger of injury and physical damage!
Do not dismantle the outdoor unit outlet.
Exposing the fan can be very dangerous.



Note!
 We advise you to contact a reliable air conditioner specialist or the Vaillant Official Technical Service to contract a preventative maintenance service. This will help to prolong the life of your equipment and improve its performance.

11 Storage over a prolonged Period

12 Product Decommissioning

11 Storage over a prolonged Period

If you do not intend to use the unit over a period of time:

- Put the fan into operation for two or three hours at a temperature of 30°C, in COOL mode and at High Speed fan in order to prevent mold or smells.
- Stop the unit and disconnect the thermal magnetic switch.
- Clean the air filters.
- Clean the Outdoor unit.
- Remove the batteries from the remote controller.

Before turning the unit back on:

- Position the remote controller batteries.
- Be sure to attach both right and left filters prior operation.
- Check that the air filters are not blocked.
- Check that the air outlet and inlet are not blocked.
- Check that the thermal magnetic switch is connected.



Danger of injury and physical damage!

In the event that the equipment is removed and reinstalled at a later date, ensure that the equipment is properly installed by personnel with the appropriate qualifications (see manual for installer). Otherwise water leakage, refrigerant leakage, short circuiting or even fire could be caused.

12 Product Decommissioning



Danger of injury and physical damage!

When disposing of the product, ensure that the necessary precautions are taken. In order to do so follow the steps described in the installation manual in reverse order and use the necessary tools and protection resources.

Ensure that the disassembly is carried out by qualified, technically competent individuals.



Warning!

Danger of environmental contamination when disposing of the unit. To avoid this, follow the instructions described in this section.



Warning!

Air conditioning systems contain refrigerants which require specialized waste disposal. The valuable materials contained in an air conditioner can be recycled.

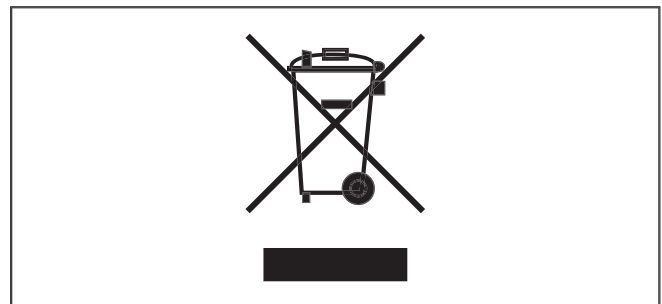

Fig. 12.1 Recycling symbol.

Your product is marked with the recycling symbol (see Figure 12.1), which means that the following must be taken into account during the disposal:

- Do not mix the unit with other domestic, unclassified waste.
- Dispose of the equipment in accordance with the relevant local and national standards, correctly and in an environmentally-friendly way.
- Hand in the unit to a waste management company that is authorised by the local authorities to transport it to a proper treatment plant.
- If the product is being replaced with a new product destined for the same use, hand in the old product to the distributor of the new unit for waste management as appropriate.
- Contact local authorities for more information.

