

For the operator/expert technician

Operating and Installation Manual auroMATIC 560



Solar Differential Controller

VRS 560

For the operator/expert technician

Operating manual auroMATIC 560

Solar Differential Controller

VRS 560

Contents

General information	3	4.9.2 One-time reheating.....	6
Special product features	3	4.9.3 Holiday function	6
1 Notes on the documentation	3	4.10 Cylinder priority	6
1.1 Storage of documents	3	4.11 Frost protection function	6
1.2 Symbols used	3	4.12 Solar circuit protection function.....	6
1.3 Validity of manual.....	3	4.13 Solar pump kick (tube collector function).....	6
1.4 CE label.....	3	5 Operation	7
2 Safety	3	5.1 Operator guidance.....	7
3 Information on installation and operation	4	5.2 Overview of controls.....	7
3.1 Vaillant warranty	4	5.3 Overview of display	7
3.2 Intended use.....	4	5.4 Display types	8
3.3 Requirements of the installation site	4	5.4.1 Display, main operating level.....	8
3.4 Care	4	5.4.2 Display, info level	8
3.5 Recycling and disposal	4	5.4.3 Display, programming level.....	8
4 Functions	5	5.4.4 Display, special functions.....	8
4.1 Solar yield	5	5.4.5 Display, service/diagnostics level.....	9
4.2 Reheating	5	5.4.6 Display, installer level	9
4.3 Reheating delay.....	5	5.5 Settings.....	9
4.4 Anti-legionella function	5	5.5.1 Calling up settings and operating values.....	9
4.5 Pump blocking protection.....	5	5.5.2 Settings at main operating level.....	9
4.6 Circulation.....	5	5.5.3 Setting the reheating function timer program.....	10
4.7 Calendar	5	5.5.4 Setting the timer program, circulation pump.....	11
4.8 Activation duration controlling	5	5.6 Activating the special functions.....	11
4.9 Special functions.....	6	6 Error messages	11
4.9.1 Advance.....	6		

General information

The auroMATIC 560 solar controller is a temperature-controlled differential controller set for solar hot water generation with a demand-oriented reheating function for Vaillant boilers.

The control set is a fully-equipped system for controlling solar systems with a collector field and a solar cylinder.

The controller can also be used in conjunction with various other components such as:

- A swimming pool heating system or
- A second solar cylinder

As well as:

- A second collector field
- A circulation pump
- A solid-fuel boiler

If a second collector field is connected, an additional collector sensor (available as an accessory) must be installed.

If a second solar cylinder or a swimming pool are added of the system, additional standard sensors (available as accessories) must be installed.

It is possible to determine the solar yield by using an additional yield sensor (available as an accessory).

Special product features

The vrDIALOG 810 diagnostic software enables the simple display and query of specific parameters using a PC, and can be obtained from Vaillant as an accessory. For this purpose, the solar controller is equipped with an eBUS interface.

1 Notes on the documentation

The following information is intended to help you throughout the entire documentation.

Further documents apply in combination with this operating and installation manual.

We accept no liability for any damage caused by failure to observe these instructions.

Other applicable documents

When operating the auroMATIC 560 solar differential controller, please observe all operating manuals for the components in the system. These operating manuals are enclosed with the relevant system parts and additional components.

1.1 Storage of documents

Please store this operating and installation manual and all other applicable documents in a safe place in case they are needed for future reference.

If you move out or sell the appliance, please give the documents to the new owner.

1.2 Symbols used

Please observe the safety instructions in this operating manual for the operation of the appliance!



Danger!
Immediate risk of serious injury or death!



Danger!
Risk of fatal electric shock!



Danger!
Danger of burning and scalding!



Caution!
Potentially dangerous situations for the product and environment!



Note
Useful information and tips.

- Symbol for a required task.

1.3 Validity of manual

This operating manual applies exclusively for units with the following article numbers: 306764, 306767.

For the article number of your unit, refer to the identification plate.

1.4 CE label

CE label indicates that the auroMATIC 560 solar differential controller complies with the basic requirements of the applicable directives in accordance with the type summary.

2 Safety

The controller must be installed by a qualified engineer, who is responsible for adhering to the existing standards and regulations.

Alterations

For alterations to the appliance or to its environment, you must refer to the recognised handicraft business which is responsible for it.



Caution!
Risk of damage due to improper alterations!
Under no circumstances should you ever attempt to make alterations to the control set or other parts of the system.

3 Information on installation and operation

3 Information on installation and operation

3.1 Vaillant warranty

We only grant a Vaillant manufacturer's warranty if a suitably qualified engineer has installed the system in accordance with Vaillant instructions. The system owner will be granted a warranty in accordance with the Vaillant terms and conditions. All requests for work during the guarantee period must be made to Vaillant Service Solutions (0870 6060 777).

3.2 Intended use

The auroMATIC 560 solar controller is a state-of-the-art appliance which has been constructed in accordance with recognised safety regulations. Nevertheless, improper use can cause serious or fatal injury to the user or others, and the appliance or other property can be damaged.

The unit is a control system for domestic hot water cylinders with solar heating, and includes a reheating option via a boiler or electrical heating rod.

Any other use or extended use is considered to be improper. The manufacturer or supplier is not liable for any resulting damage. The user alone bears any risk. Intended use includes the observance of the operating manual and all other applicable documents.



Caution!

Any improper use is forbidden.

3.3 Requirements of the installation site

The controller must be installed in a dry room.

3.4 Care

You can clean the casing of the controller with a damp cloth and a little soap.



Note

Do not use abrasive cleaners or detergents that could cause damage, especially to the display.

3.5 Recycling and disposal

Neither the controller or any of its accessories belong in the household waste. Make sure the old appliance and any existing accessories are disposed of properly.

4 Functions

4.1 Solar yield

The solar controller works on the principle of differential temperature control system. The controller always switches on the collector pump when the difference in temperature (collector temperature - cylinder temperature) is greater than the programmed activation difference.

The controller switches off the collector pump when the difference in temperature (collector temperature - cylinder temperature) is less than the programmed deactivation difference.

The expert technician sets the parameters to the installer level when the solar controller is installed.

The solar yield is determined from:

- The difference in temperature between the collector's forward flow and return flow
- The flow value specified (during installation) at the control valve of the flow rate limiter
- The running time of the collector pump

During installation the expert technician sets the flow rate limiter and enters the flow rate into the solar controller at the installer level. The solar yield is calculated by the solar controller. The total yield can be called up and reset in the installer level.

4.2 Reheating

The reheating function allows the cylinder to heat up to the required temperature during a set time window, even if the solar yield is insufficient. In this case the water can be reheated using an external heater or an electrical heating rod. You can set up time windows for reheating the solar cylinder (see Section 5.5.3 for details).

4.3 Reheating delay

The controller is equipped with a reheating delay function to prevent unnecessary reheating by an external heater or an electrical heating rod. This function delays reheating by up to 30 min. in case the collector pump is running and the solar yield becomes available. If the collector pump remains off and/or the desired cylinder temperature is not reached after the delay period, the cylinder is reheated using the external heater or electrical heating rod.

The reheating delay function is activated in the installer level.

4.4 Anti-legionella function

The anti-Legionnaire's disease protection function is designed to kill germs in the cylinder and pipelines.

When the function is activated, the cylinder, the corresponding hot water pipes and circulation pump (if installed) are brought to a temperature of at least 60 °C once a week at a specific time on a specific day, or every day.

In doing so, the cylinder temperature is raised to 71 °C and the corresponding circulation pump is switched on (if installed). The anti-legionella function is implemented either via an external heater or electrical heating rod if this is used for reheating. The anti-Legionnaire's disease protection function will stop once a temperature of at least 68 °C has been maintained for a period of 30 minutes.

The anti-legionella function is activated by the expert technician at installer level.

4.5 Pump blocking protection

If no pumping has occurred for 23 hours, all installed pumps are switched on for roughly 3 seconds to prevent the pumps from seizing.

4.6 Circulation

If you only have one collector field connected, a circulation pump can be connected to the controller. You can specify up to three heating windows for the circulation pump in the timer program (see Sec. 5.5.4). Set up the time program so that the circulation pump only operates at times when you expect a supply of hot water demand will be needed. Otherwise the circulation pump operates unnecessarily and inadvertently cools down the cylinder.

4.7 Calendar

The controller is equipped with a calendar so that it can automatically adjust for daylight-savings time. To activate it, simply enter the current date in the installer level.

Note

Please observe that in the event of a power failure the controller only has a power reserve of 30 minutes. After 30 minutes, the internal clock stops and the calendar will not automatically resume function once power has been restored. In this case the time and date will need to be reset.

4.8 Activation duration controlling

Activation duration controlling serves to keep the solar circuit at the activation value, and thus in operation, for as long as possible. The pump is switched on and off in periodical bursts depending on the difference between the collector temperature and lower cylinder sensor. When the activation difference is reached, the function is started (if activated) with an activation duration of 30 % - i.e. the pump is switched on for 18 seconds and then switched off for 42 seconds. If the difference in temperature increases, the activation duration is prolonged (e.g. 45 seconds on, 15 seconds off). If the difference in temperature falls, the activation duration is reduced (e.g. 20 seconds on, 40 seconds off). The period length is always a minute. Activation duration control is activated in the installer level.

4 Functions

4.9 Special functions

Please refer to Sec. 5.6 for information on how to activate the following special functions.

4.9.1 Advance

When the advance is activated, the reheating function is enabled. This means that the set target value for the cylinder will be maintained by reheating if necessary.

4.9.2 One-time reheating

When this function is activated, the cylinder temperature is reheated to the set level one time.

4.9.3 Holiday function

When this function is activated, the operating mode is switched to "OFF" for the set holiday period (1 to 99 days). This deactivates both the solar yield and the reheating function.

4.10 Cylinder priority

Two solar-charged cylinders can be connected to the heating installation. You can use the PRIO cylinder priority function to define which cylinder should be charged as the highest priority.

This is normally the drinking water cylinder. The cylinders can only be clearly identified via the cylinder sensors (cylinder 1 = Sp 2; cylinder 2 = SP 3).

You can only change this setting at the installer level. The cylinder that has been assigned the highest priority will always be charged if the collector temperature is greater than the sum of the actual temperature in the cylinder and the activation difference specified. The heating of the cylinder will stop once the maximum temperature for the cylinder is reached, or if the collector temperature is less than the actual cylinder temperature plus the set deactivation difference.

The second cylinder can only be heated when the first cylinder is not being heated. The charging of the second cylinder is interrupted for at least 5 minutes every 15 minutes to check whether the cylinder can be charged with the highest priority. The same activation and deactivation conditions apply here as well.

4.11 Frost protection function

The frost protection function is relevant to Spain only due to statutory regulations and is deactivated in the as-delivered condition (standard setting: OFF).



Note

This function should not be activated to prevent undesired cooling of the cylinder.

4.12 Solar circuit protection function

If the solar heat exceeds the current heat demand (e.g. all cylinders fully charged), the temperature may occur in the collector field may increase rapidly.

If the safety temperature at the collector sensor is exceeded, the collector pump is switched off to protect the solar circuit (solar pump, valves, etc.) from overheating, or restarting is prevented if a solar reheating requirement exists. The solar pump is switched back on once the system has cooled down. This function is executed independently for each collector field.

4.13 Solar pump kick (tube collector function)

Depending on the design of the tube collectors, the measured value obtained for the purposes of temperature recording may be subject to a time delay. This can be reduced via the tube collector function.

Measured value of collector temperature with active tube collector function:

The solar pump is switched on for 15 s (solar pump kick) once the temperature at the collector sensor has risen by 2 °C. The heated solar fluid is thereby transported more quickly to the measuring point.

If the temperature difference between the collector and cylinder temperature is at least 10 °C) the solar pump runs for as long as is necessary to heat the cylinder up (differential control). If two solar circuits are connected, the tube collector function is activated for both solar circuits.

The function is implemented separately in each case for all collector fields.

5 Operation

5.1 Operator guidance

The controller has a display which consists of symbols, and is designed according to the Vaillant "turn and click" operating concept. You can call up and set values by turning the dial. You can also click the dial in order to call up values within an operating level. You can access the operating and display levels with the three selection buttons.

To prevent operating errors, the programming button must be held down for roughly three seconds to reach the installer level.

5.2 Overview of controls

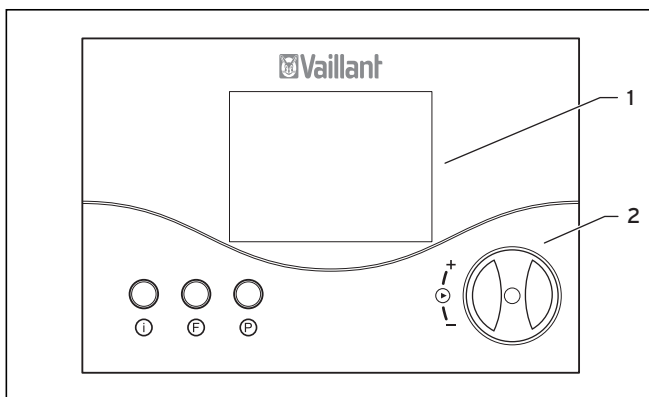

Fig. 5.1 Controls

Key

- 1 Display
- 2 Dial (turn and click)
- i Information button
- F Special functions button
- P Programming button

5.3 Overview of display

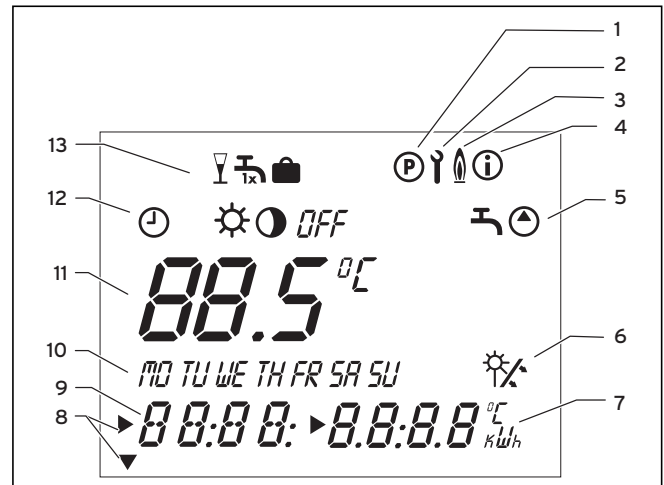

Fig. 5.2 Display

Key

- 1 Programming level
- 2 Service/diagnostics level
- 3 Reheating
- 4 Info level
- 5 Programming of timer programs
- 6 Solar yield (flashes if solar yield is available)
- 7 Units
- 8 Cursor
- 9 Multi-function display
- 10 Weekdays
- 11 Target/actual value
- 12 Operating modes
- 13 Special functions

Display symbols

Timer programs:

- Timer program for reheating function
- Programming of timer program for connected circulation pump

Operating modes:

- Reheating function with timer program
- Reheating function in constant standby mode
- No reheating
- No actuation of solar pump(s), no reheating

Special functions:

- Party
- One-time reheating
- Holiday function

5 Operation

5.4 Display types

5.4.1 Display, main operating level

The main operating level appears when the appliance is switched on. Please refer to Sec. 5.5.2 for information on how to set and change the values.

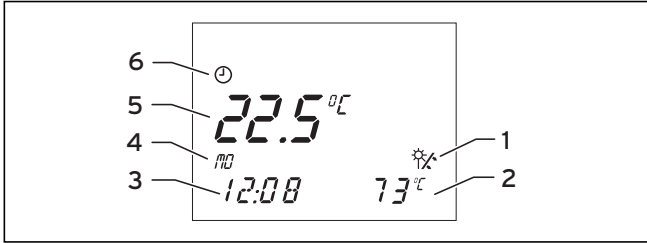

Fig. 5.3 Display, main operating level

Key

- 1 Display, solar yield present
- 2 Actual collector temperature
- 3 Actual time or LEG for anti-legionella function (if active); FROS for frost protection function; PROT for solar circuit protection function
- 4 Current day of the week
- 5 Current temperature of cylinder (the target temperature can be called up and adjusted by turning the dial)
- 6 Current operating mode

5.4.2 Display, info level

You can access the info level by pressing the info button. The display initially appears as seen in the diagram below. You can call up additional information by pressing the info button again (see Sec. 5.5.1). The information called up appears on the display for roughly five seconds, then the display returns to the main operating level.

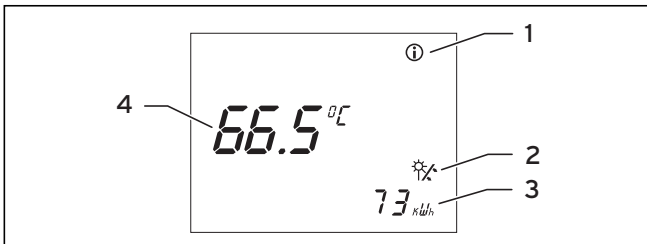

Fig. 5.4 Display, info level

Key

- 1 Info level
- 2 Display, solar yield
- 3 Yield in kWh
- 4 Set target temperature of cylinder

5.4.3 Display, programming level

You can access the level for programming the controller's operating times by pressing the "P" programming button. You can set timer programs here for reheating the solar cylinder and for a connected circulation pump (see Section 5.5.3 or 5.5.4).

The display returns to the main operating level if you press the programming button.

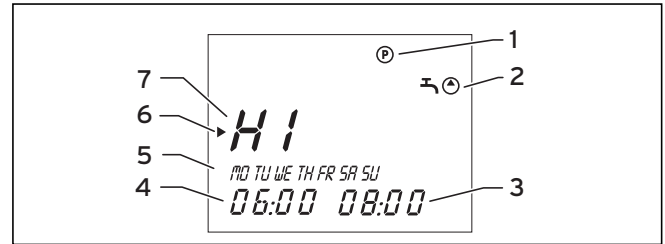

Fig. 5.5 Display, programming level

Key

- 1 Programming level
- 2 Timer program for solar cylinder reheating (water tap symbol) or circulation pump (pump symbol)
- 3 End time
- 4 Start time
- 5 Day of the week or block of days
- 6 Cursor (marks the value to be changed)
- 7 Time window

5.4.4 Display, special functions

By pressing the "F" button, you can access the special functions: party, one-time reheating, and holiday function. After roughly ten seconds, the selected function is activated and the display returns to the main operating level.

Please refer to Sec. 5.6 for information on how to activate the individual special functions.

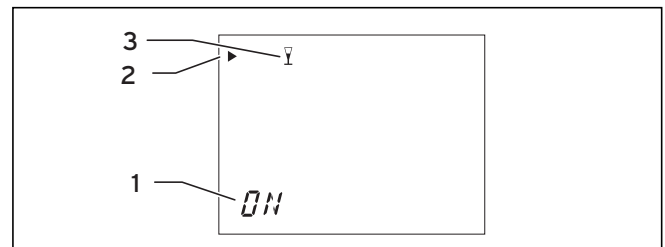

Fig. 5.6 Display, special functions

Key

- 1 Special function activated
- 2 Cursor (marks the special function selected)
- 3 Symbol for the special function selected

5.4.5 Display, service/diagnostics level

The actuators and sensors should be checked by the technician expert.

You can access the service/diagnostics level by simultaneously pressing the programming button "P" and the dial for roughly 3 seconds. All actuators and sensors can be controlled and checked in this level (see Chapter 7 in the installation instructions).

The display returns to the main operating level if you press the programming button.

5.4.6 Display, installer level

The parameters at installer level should only be adjusted by an expert technician.

You can access the installer level by pressing the programming button "P" for at least 3 seconds.

Press the programming button briefly to return to the basic display.

5.5 Settings

5.5.1 Calling up settings and operating values

You can call up the values set at the info level successively by pressing the info button repeatedly.

Once called up, the information remains in the display for roughly five seconds then the display returns to the main operating level.

Display	Settings
	Cylinder temperature target value Yield
	Cylinder sensor 1 temperature
	Cylinder sensor 2 temperature
	Cylinder sensor 3 temperature (if connected)

Table 5.1 Values for settings

Display	Settings
	Collector sensor 1 temperature
	Collector sensor 2 temperature (if connected)
	Operating hours, solar pump 1
	Operating hours, solar pump 2
	The current date is only displayed in the following cases - a valid date is entered during start-up and - the calendar has been activated.
	Timer program for heating window

Table 5.1 Values for settings (continued)

Further displays will be shown here depending on how many timer programs you have set (see Sections 5.5.3 and 5.5.4).

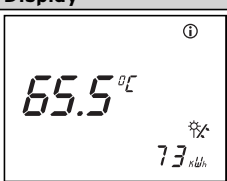
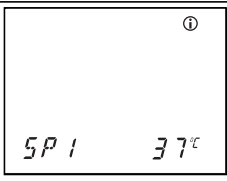
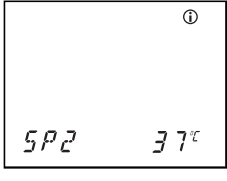
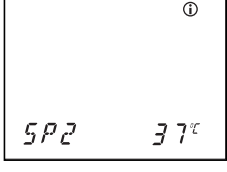
5.5.2 Settings at main operating level

You can adjust the following settings in the main operating level:

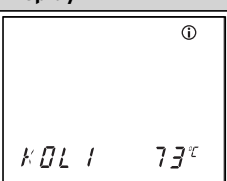
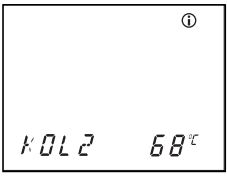
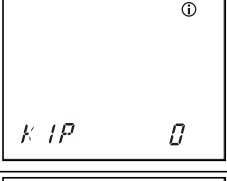
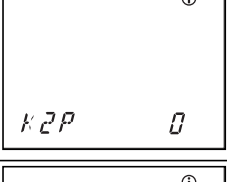
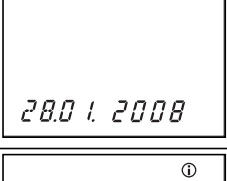
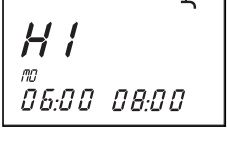
- Cylinder temperature target value,
- Operating mode,
- Current day of the week,
- Current time

When you call up a setting, it can be viewed and/or changed for roughly five seconds before the basic display at the main operating level reappears automatically. Click the dial within the five second period to display the next setting.

5 Operation

Operating modes:



Reheating function with timer program



Reheating function in constant standby mode



No reheating



No actuation of solar pump(s), no reheating



Reheating function in automatic mode - the corresponding symbol for the time window status is displayed next to the clock symbol. Time window active



Reheating function in automatic mode Time window not active

Display	Required steps
	Turn the dial, after 3 seconds the cursor marks the temperature display, which will be flashing. Turn the dial to adjust the target value for the cylinder temperature.
	Click the dial - The cursor will mark the operating modes. The selected operating mode flashes. Select an operating mode by turning the dial.
	Click the dial - The cursor will mark the day of the week. The selected day of the week flashes. Turn the dial to select the current day of the week.
	Click the dial - The cursor will mark the hours and/or the minutes. Turn the dial to adjust the current time.

Table 5.2. Settings in the main operating level

5.5.3 Setting the reheating function timer program

You can create a timer program with up to three time windows for reheating the solar cylinder. The controller is equipped with a default program which can be customised to meet your individual needs.

Time window	Weekday/Block of days	Start time	End time
H 1	MO - SO	5:30	22:00
H 2	-	-	-
H 3	-	-	-

Table 5.3 Default reheating program

There are four steps to setting the times you want:
1. Select the time window,
2. Select a weekday or block of days,
3. Specify the start time,
4. Specify the end time.

You can specify up to three time windows, as long as none of the time windows overlap another.

For clarification, the individual steps are shown in the following table:

Display	Required steps
	Press the programming key P Turn the dial until you see the tap symbol.
	Click the dial - The cursor marks the changeable value (H1), which also flashes. Select the time window by turning the dial. Settings: H 1, H 2, H 3
	Click the dial - The cursor marks the block of days display, which also flashes. Select a block of days or a single day of the week by turning the dial. Settings: (MO-SU); (MO - FR); (SA-SU); (MO); (TU); (WE); (TH); (FR); (SA); (SU)
	Click the dial - The cursor marks the start time and the hour display flashes. Select the start time by turning the dial. Click the dial again to set the minutes.
	Click the dial - The cursor marks the end time and the hour display flashes. Select an end time by turning the dial. To adjust the minutes, click the dial again.

Table 5.4 Setting time windows

5.5.4 Setting the timer program, circulation pump

You can create a customised timer program for a connected circulation pump (only possible for hydraulic plan 1), just as you can for the reheating function. The controller is equipped with a default program for this as well:

Time window	Weekday/ Block of days	Start time	End time
H 1	MO - SO	6:00	22:00
H 2	-	-	-
H 3	-	-	-

Table 5.5 Default circulation pump program

You can access the timer program for the circulation pump by pressing programming button "P" and turning the dial until the pump symbol appears in the display instead of the water tap symbol. The setting of the desired heating times is done in the same manner as the setting of the heating times for the reheating function (see Sec. 5.5.3). Set up the timer program so that the circulation pump only operates at times when you expect a supply of hot water will be needed. Otherwise the circulation pump operates unnecessarily and inadvertently cools down the cylinder.

5.6 Activating the special functions

Display	Required steps
	Advance Press the special function button once - the party symbol flashes for approx. ten seconds in the display, then the function is activated. The function is deactivated automatically when the next reheating window begins. If you want to deactivate the function before, simply reselect the function. The function can only be activated in the reheating operation mode ☺.
	One-time reheating Press the special function button twice - The one-time reheating symbol flashes in the display for approx. ten seconds, then the function is activated. If you want to deactivate the function before, simply reselect the function.
	Holiday function Press the special function button three times - the holiday function symbol flashes in the display for approx. ten seconds, and you can use the dial to set the number of holidays. Finally, the function is activated for the set time. If you want to deactivate the function before, simply reselect the function. If the anti-Legionnaire's disease function is activated, the protection will be carried out on the last holiday.

Table 5.6 Activating the special functions

6 Error messages

The auroMATIC 560 solar controller shows error messages in the main operating level if there is a problem with the temperature sensor.

The sensor configuration will always be displayed when the controller is switched on for the first time, or if the power supply has been switched off and on again. Depending on the set hydraulic plan, the controller recognises whether there is an error, or if the sensor is not necessary for operation.



Caution!

Never try to repair or carry out maintenance work on the controller yourself. Call in an approved technician. We recommend concluding a maintenance contract for your solar system with a recognised handicraft business.

The following table explains the error messages.

Display	Message/Description
	Error cylinder sensor 1 This error occurs if there is a problem with the connected sensor.
	Error cylinder sensor 2 This error occurs if there is a problem with the sensor, or if it is not connected.
	Error cylinder sensor 3 This error occurs if there is a problem with the connected sensor.

Table 6.1 Error messages

No error messages are output for collector sensors Kol 1 and Kol 2. A plausibility check is still possible, e.g. by comparing the collector temperature with the outside temperature.

For the operator/expert technician

Installation Manual

auromATIC 560

Solar Differential Controller

VRS 560

Contents

1	Notes on the documentation.....	2	6	Start-up.....	20
1.1	Storage of documents	2	6.1	Setting system parameters.....	20
1.2	Symbols used	2	6.2	Resetting the system parameters to the default setting.....	23
1.3	Validity of manual.....	2			
2	Description of the unit.....	2	7	Service/diagnostics.....	23
2.1	CE label.....	2	8	Emergency mode.....	25
2.2	Intended use.....	2	9	Technical data.....	25
3	Safety instructions and regulations	3	10	Sensor characteristics.....	26
3.1	Safety instructions	3	11	Vaillant Service.....	26
3.2	Regulations.....	3			
4	Assembly	3			
4.1	Scope of delivery	3			
4.2	Assembly of VR 10 standard sensor	3			
4.3	Accessories.....	3			
4.3.1	VR 10 standard sensor	3			
4.3.2	VR 11 collector sensor	3			
4.4	Installing the controller housing	4			
5	Electrical installation	4			
5.1	Wiring according to hydraulic plan.....	5			
5.2	Hydraulic plan 1.....	6			
5.3	Hydraulic plan 2.....	12			
5.4	Hydraulic plan 3.....	16			

1 Notes on the documentation

2 Description of the unit

1 Notes on the documentation

The following information is intended to help you throughout the entire documentation. Further documents apply in combination with this operating and installation manual.

We accept no liability for any damage caused by failure to observe this manual.



Caution!

This document is not a manual for making hydraulic connections. The appropriate documents should be referred to for this.

Other applicable documents

For the expert technician:

- This operating and installation manual
- Operating, assembly, and installation instructions for the additional components

1.1 Storage of documents

Please give this operating and installation manual and all other applicable documents and auxiliary equipment to the owner of the system. The owner shall ensure that the manuals and auxiliary equipment are properly stored, so that they are available whenever required.

1.2 Symbols used

Please observe the safety instructions in this installation instructions when installing the appliance!



Danger!

Immediate risk of serious injury or death!



Danger!

Risk of fatal electric shock!



Danger!

Danger of burning and scalding!



Caution!

Potentially dangerous situations for the product and environment!



Note

Useful information and tips.

- Symbol for a required task.

1.3 Validity of manual

These installation instructions apply exclusively for units with the following article numbers: 306764, 306767. For the article number of your unit, refer to the identification plate.

2 Description of the unit

2.1 CE label

The CE label indicates that the controller meets the basic requirements of the Council of Europe's directive 89/336/EEC for electromagnetic compatibility.

2.2 Intended use

The auroMATIC 560 controller is a state-of-the-art appliance which has been constructed in accordance with recognised safety regulations. Nevertheless, improper use can cause serious or fatal injury to the user or others, and the appliance or other property can be damaged.

The unit is a control system for domestic hot water cylinders with solar heating, and includes a reheating option via a boiler or electrical heating rod.

Any other use or extended use is considered to be improper. The manufacturer or supplier is not liable for any resulting damage. The user alone bears any risk. Intended use includes the observance of the operating and installation manuals, and all other applicable documents.



Caution!

Any improper use is forbidden.

3 Safety instructions and regulations

3.1 Safety instructions

The controller must be installed by a qualified engineer, who is responsible for adhering to the existing standards and regulations. We accept no liability for any damage caused by failure to observe these instructions.



Danger!

Risk of fatal electric shock from touching live connections.

Before working on the unit, switch off the power supply and secure against restart. Only remove the controller from the wall installation or it pull out of the plinth once the power supply has been switched off.

3.2 Regulations

All wiring must be in accordance with Building Regulations Part P and BS 7671 (IEE Wiring Regulations), and must be carried out by a suitably qualified person.

Use standard wires for wiring.

Minimum cross-section of wires:

- Power supply 230 V (pump connection cable): 1.5 mm²
- Extra-low voltage lines (sensor wires): 0.75 mm²

Connections with 230 V and sensor wires must be laid separately if longer than 10 m.

230 V connection leads must be supplied in 1.5 mm² and fastened to the wall installation using the accompanying cable clamps.

Do not use free terminals on the appliances as support terminals for other wiring.

The controller must be installed in a dry room.



Danger!

Danger of scalding due to hot water! The temperature of the solar hot water storage tank may sometimes be considerably higher than 60 °C (due to the solar heating, but also the anti-legionella function, if activated). Have your expert technician install a mixer valve with cold water supply without fail. Have the mixer valve adjusted by your expert technician.

4 Assembly

4.1 Scope of delivery

Using Table 4.1, verify the scope of delivery for the controller set.

Item	Quantity	Components
1	1	auroMATIC 560 controller
2	1	VR 11 collector sensor
3	3	VR 10 standard sensor
4	1	C1/C2 cable

Table 4.1 Scope of delivery

4.2 Assembly of VR 10 standard sensor

The VR 10 standard sensor is designed so that it can be used as an immersion sensor or surface mount sensor. When used as a surface mount sensor, the sensor is secured to the forward flow pipe or the return pipe using the supplied tension band. In order to guarantee good heat transfer, the sensor is flat on one side. We also recommend that the pipe with the sensor is insulated, in order to enable the best possible measuring of temperature.

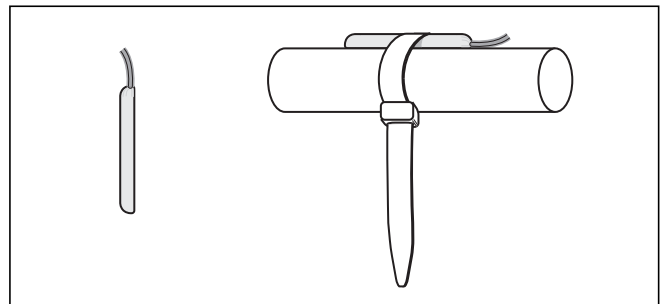

Fig. 4.1 VR 10 standard sensor

4.3 Accessories

The following accessories are necessary in order to connect a second collector field or an additional solar cylinder to the controller, and to enable measurement of the solar yield.

4.3.1 VR 10 standard sensor

The use of additional standard sensors is necessary if you want to connect a second solar cylinder to the controller.

4.3.2 VR 11 collector sensor

If a second collector field is connected, it is necessary to install a second collector sensor from the Vaillant accessory range.

4 Assembly

5 Electrical installation

4.4 Installing the controller housing

The controller is designed to be mounted on a wall and is equipped with System ProE terminal strips. These terminals must be used for all connections made at the installation site.

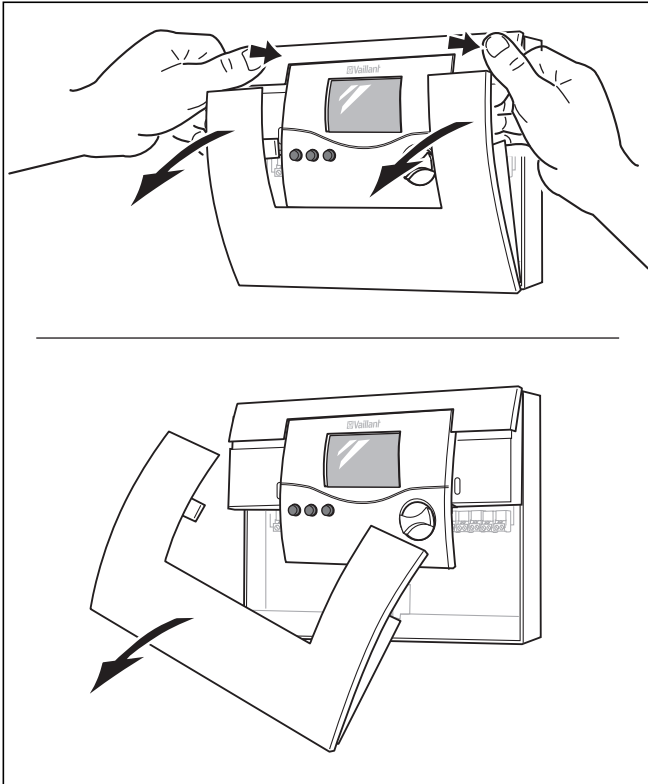

Fig. 4.2 Opening the controller housing

The cover consists of two parts, which can be removed separately.

- As shown in Fig. 4.2, pull the lower front cover off of the controller housing.

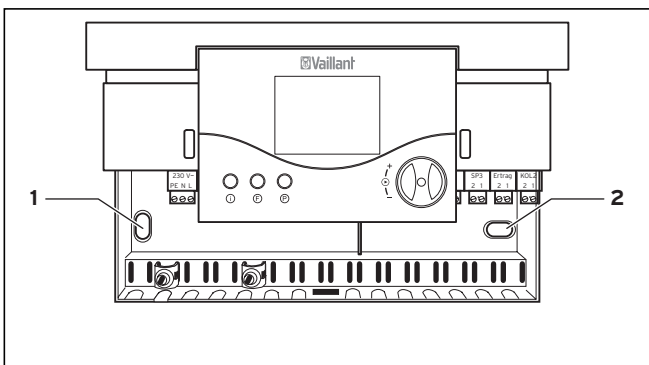

Fig. 4.3 Fastening the controller housing

- Mark the position of both holes (**1** and **2**) and drill the bore holes.
- Select the wall plugs to suit the state of the wall, and screw the controller housing on tightly.

ProE-system wiring

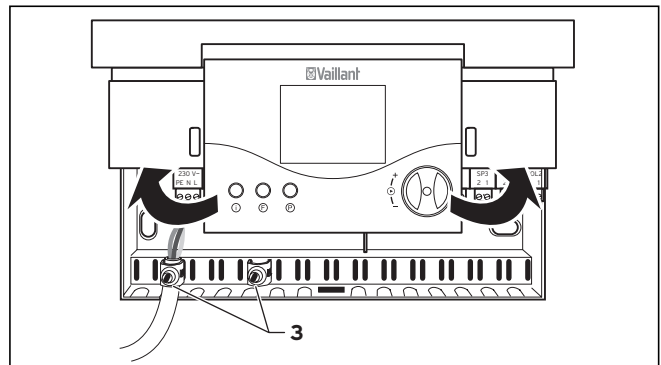

Fig. 4.4 Fold-up the control panel

- Fold the control panel towards the top.
- Wire the controller according to the selected hydraulic plan (see Section 5.1).
- Secure all cables with the accompanying cable clamps (**3**).
- Fold the control panel back down.
- Attach the front cover again.

5 Electrical installation

The electrical connection may only be carried out by an approved specialist company.



Danger!

Risk of fatal electric shock from touching live connections. Before working on the appliance, turn off the power supply and secure against restart.



Caution!

The circuit board can be damaged if short circuited through the connection leads. For safety purposes, a max. of 30 mm of insulation may be removed from the ends of 230 V leads which will be connected to ProE plugs. If more insulation is removed, there is a risk of short circuiting the circuit board.

Caution!

When exchanging the controller in an existing system, sensor-curve characteristics should be taken into consideration (see Sec. 11), and the sensors should be replaced if necessary!

**Caution!**

An optional electrical heating rod (EP) must be installed with an additional relay or contactor with a circuit-breaking capacity of at least 16 A. Never operate an electrical heating rod in connection with the auroMATIC 560 without an additional external relay or contactor.

Caution!

The C1/C2 contact is a 24 V low-voltage contact and should never be used as a 230 V switching contact.

5.1 Wiring according to hydraulic plan

To simplify installation, three hydraulic plans are stored in the controller. The relevant plan must be selected according to the system configuration used.

Each of the hydraulic plans show a possible system configuration in which some system components are optional.

**Caution!**

These hydraulic plans are only schematic representations and cannot be used for the preparation of the hydraulic piping.

Hydraulic plan	Bivalent cylinder	Monovalent cylinder	Number of collectors	Circulation pump connected	Solid-fuel boiler connected	Integration of second cylinder or swimming pool
1	X		1	yes	no	yes
		X	1	no	no	yes
2	X		2	no	no	yes
3	X		1	no	yes	yes

Table 5.1 System configuration

5 Electrical installation

5.2 Hydraulic plan 1

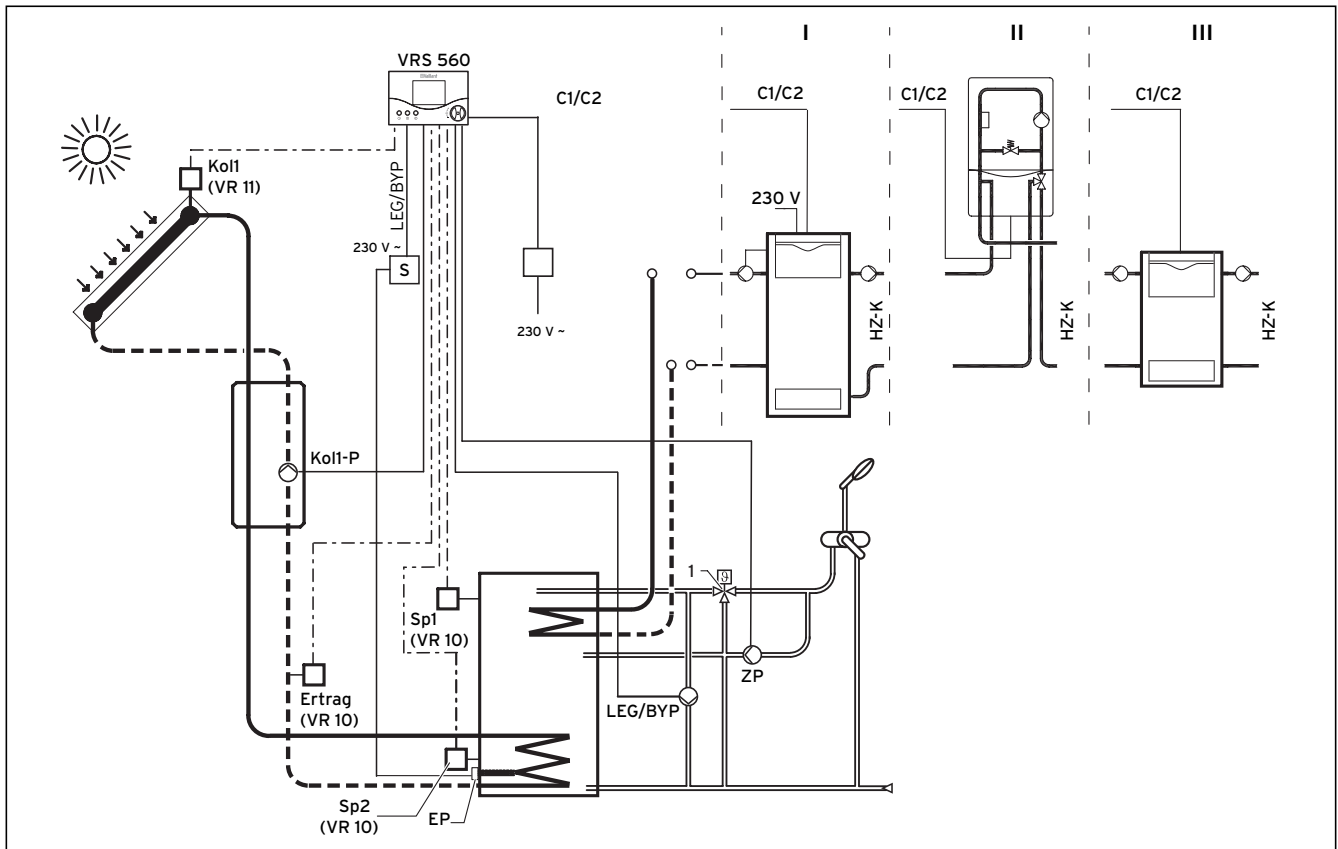

Fig. 5.1 Hydraulic plan 1 with system configuration: one collector field, one solar cylinder, connection option for various heaters for reheating the cylinder

Designation in hydraulic plan/wiring diagram	Components
I, II, III	Connection option for various heaters for reheating the cylinder
C1/C2	Connections for controlling the heater used for reheating the cylinder
HZ-K	Heating circuit(s)
KW	Cold water
ZP	Circulation pump
EP	Electrical heating rod (optional)
Kol1-P	Solar circuit pump 1
Kol1	Collector sensor 1
Yield	Sensor for measuring yield (optional)
LEG/BYP	Legionella protection pump or electric heater cartridge
Sp1	Cylinder sensor 1
Sp2	Cylinder sensor 2

Table 5.2 Key for Fig. 5.1 and Fig. 5.2

Designation in hydraulic plan/wiring diagram	Components
S	Control of contactor for optional electrical heating rod
1	Mixer valve
230 V	230 V main power connection
F1 (T4)	Fuse holder
VC/VK	Heater wiring area

Table 5.2 Legend for Fig. 5.1 and Fig. 5.2 (continued)



Danger!

Danger of scalding due to hot water.

The mixer valve must be installed without fail to ensure protection against scalding.

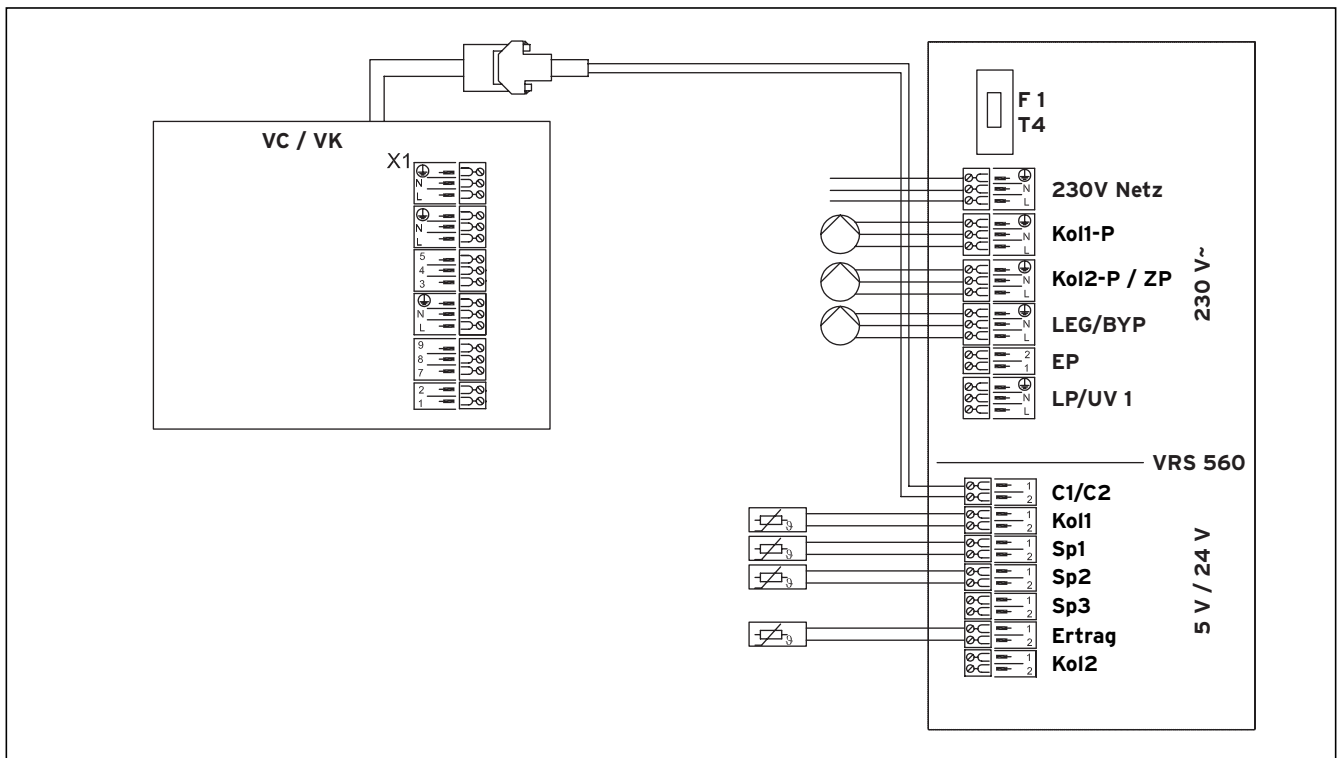

Fig. 5.2 Connection diagram for hydraulic plan 1



Note

LEG/BYP can be used as a legionella protection pump or an electric heater cartridge. Only one of these options can be used.

5 Electrical installation

Hydraulic plan 1: Connection of a second cylinder or swimming pool

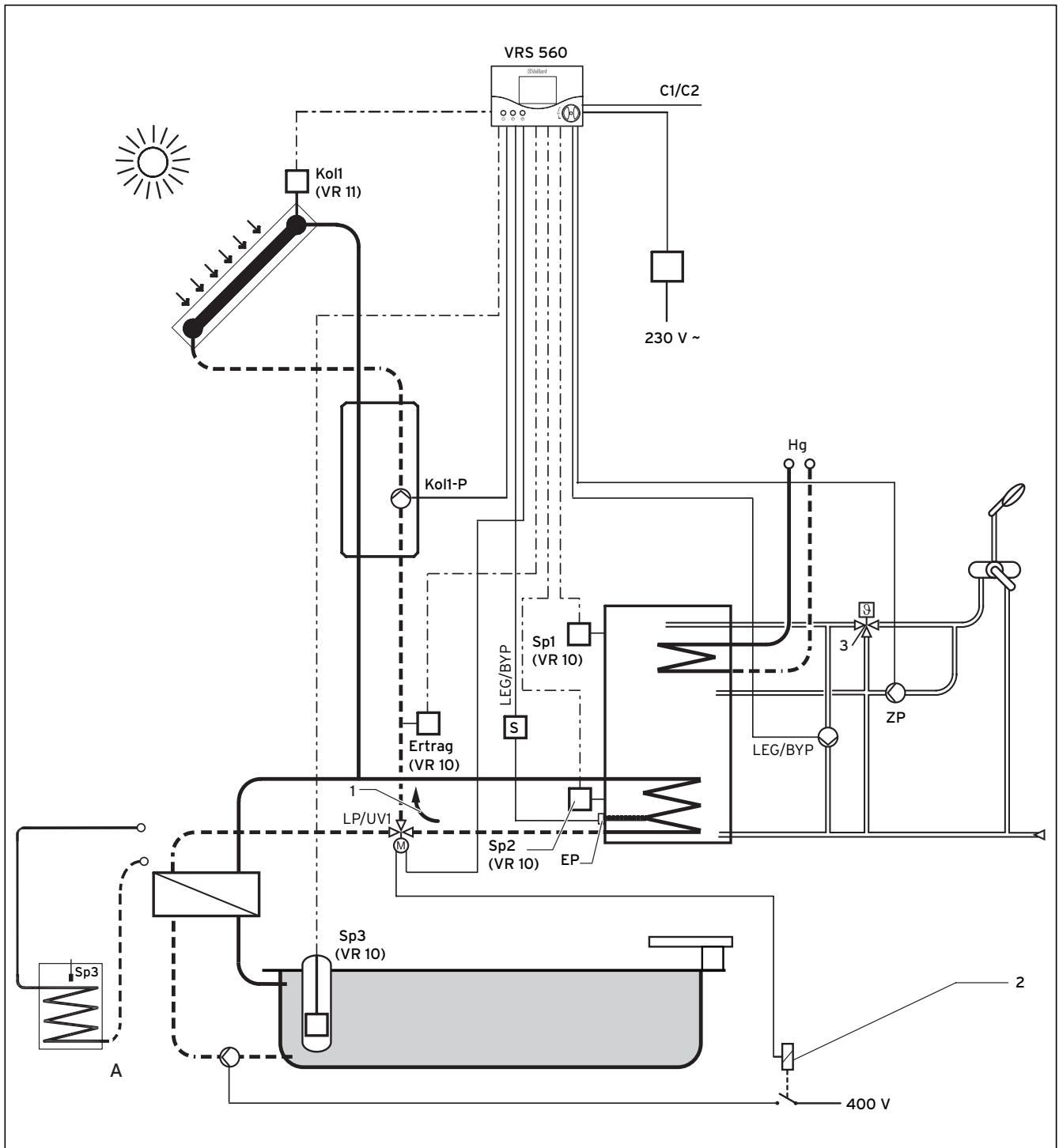

Fig. 5.3 Hydraulic plan 1: Connection of a second cylinder or swimming pool



Danger!
Danger of scalding due to hot water.
The mixer valve must be installed without fail to ensure protection against scalding.

Designation in hydraulic plan/wiring diagram	Components
C1/C2	Connections for controlling the heater used for reheating the cylinder
Hg	Boiler
KW	Cold water
ZP	Circulation pump
EP	Electrical heating rod (optional)
SR	Swimming pool controller (provided by customer)
LP/UV 1	Diverter valve
1	LP/UV 1 diverter valve in de-energised state
A	Alternative connection for second cylinder
Kol1-P	Solar circuit pump 1
Kol1	Collector sensor 1

Table 5.3 Key for Fig. 5.3 and Fig. 5.4

Designation in hydraulic plan/wiring diagram	Components
Yield	Sensor for measuring yield (optional)
LEG/BYP	Legionella protection pump or electric heater cartridge
Sp1	Cylinder sensor 1
Sp2	Cylinder sensor 2
Sp3	Cylinder sensor 3
S	Control of contactor for optional electrical heating rod
2	400 V connection, 3 phase
3	Mixer valve
230 V	230 V main power connection
F1 (T4)	Fuse holder
VC/VK	Heater wiring area

Table 5.3 Legend for Fig. 5.3 and Fig. 5.4 (continued)

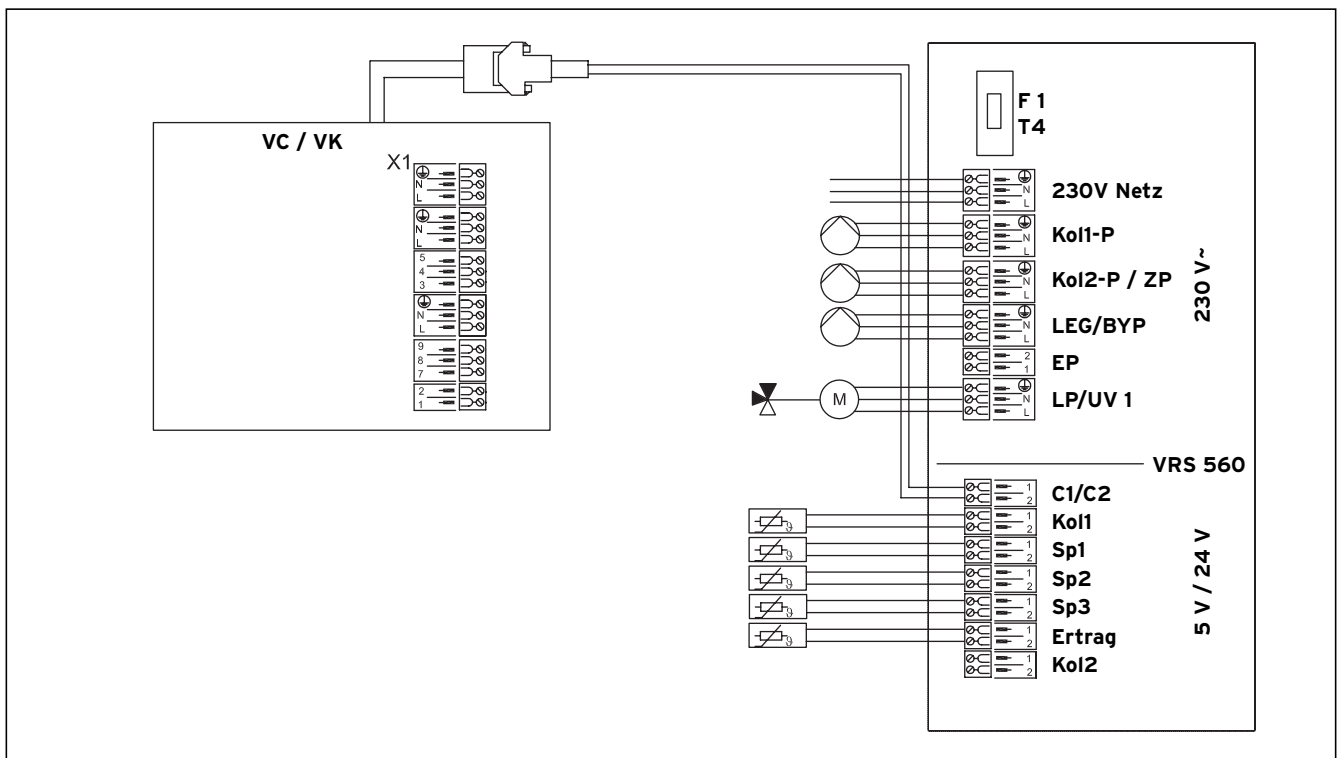

Fig. 5.4 Connection diagram for hydraulic plan 1 Connection of a second cylinder or swimming pool

Note
LEG/BYP can be used as a legionella protection pump or an electric heater cartridge. Only one of these options can be used.

5 Electrical installation

Hydraulic plan 1: integration into monovalent systems

The controller can also be used in conjunction with units that heat water according to the principle of instantaneous heating. Integrate the controller according to the following hydraulic plan.

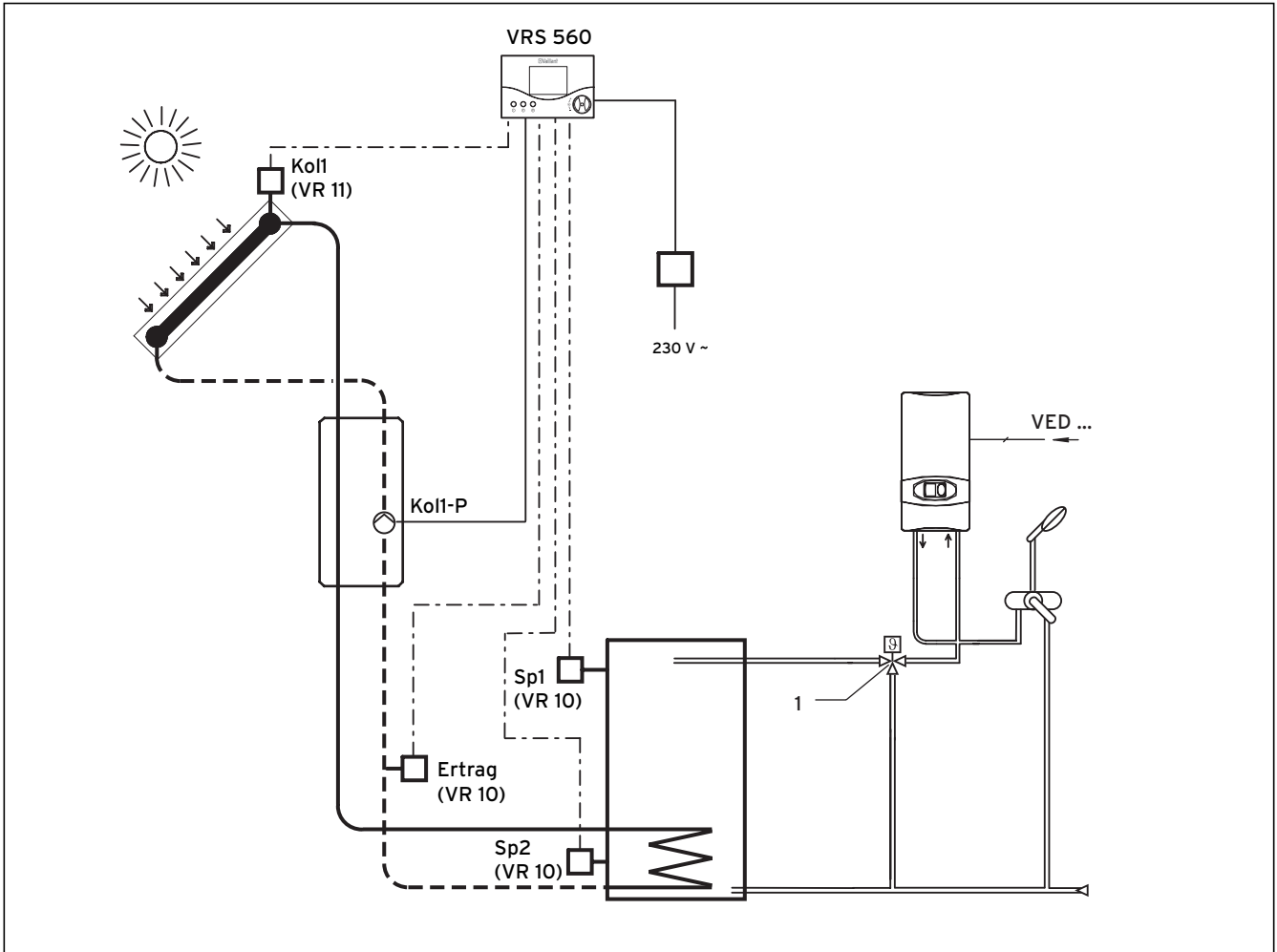

Fig. 5.5 Hydraulic plan 1: integration into monovalent systems

Designation in hydraulic plan/wiring diagram	Components
VED...	Vaillant electric instantaneous heater
Kol1-P	Solar circuit pump 1
Kol1	Collector sensor 1
Sp1	Cylinder sensor 1
Sp2	Cylinder sensor 2
230 V	230 V main power connection
F 1 (T4)	Fuse holder
Yield	Sensor for measuring yield (optional)
1	Mixer valve
230 V	230 V main power connection

Table 5.4 Key for Fig. 5.5 and Fig. 5.6



Danger!
Danger of scalding due to hot water.
The mixer valve must be installed without fail to ensure protection against scalding.

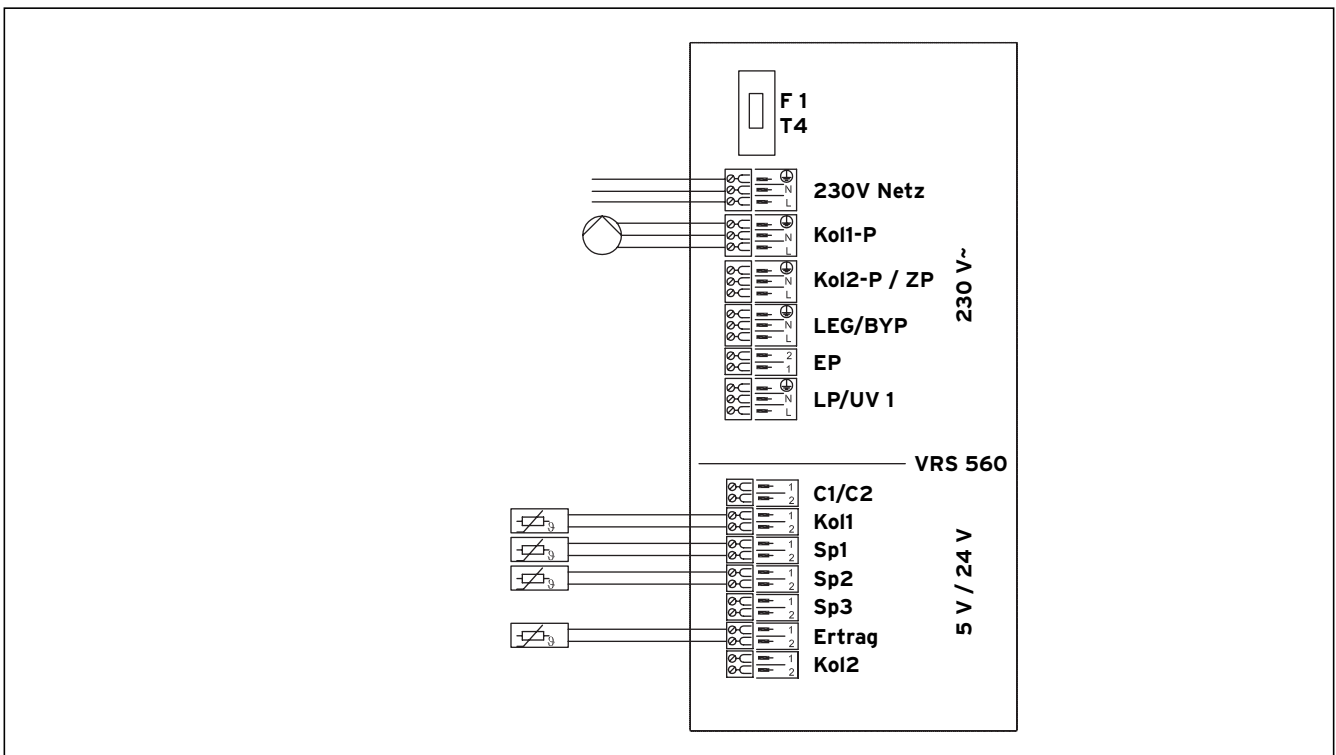

Fig. 5.6 Connection diagram for hydraulic plan 1: Integration of auroMATIC 560 in monovalent systems



Danger!

Danger of overheating!

When integrating the controller, always install a thermostatic mixer valve to limit the maximum temperature to prevent scalding and protect the unit. Depending on the boiler, set it at 60 °C (for example).



Note

The VED E Solar monitors the inlet temperature independently and switches in the hot water post-heating according to the temperature of the solar cylinder. An additional control command is not required in this case.

5 Electrical installation

5.3 Hydraulic plan 2

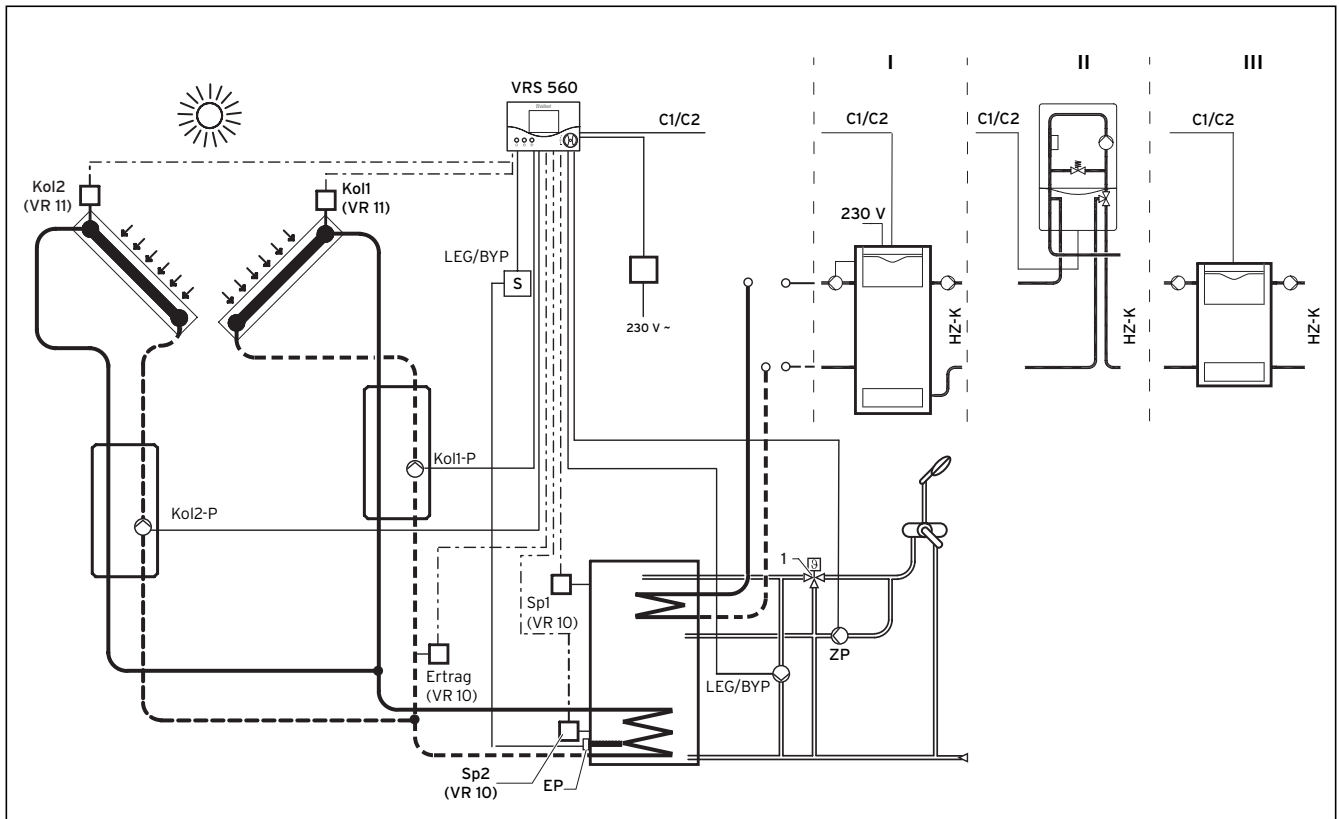

Fig. 5.7 Hydraulic plan 2 with system configuration: Two collector fields, one solar cylinder, connection option for various heaters for reheating the cylinder

Designation in hydraulic plan/wiring diagram	Components
I, II, III	Connection option for various heaters for reheating the cylinder
C1/C2	Connections for controlling the heater used for reheating the cylinder
HZ-K	Heating circuit(s)
EP	Electrical heating rod (optional)
Kol1-P	Solar circuit pump 1
Kol2-P	Solar circuit pump 2
Kol1	Collector sensor 1
Kol2	Collector sensor 2
Yield	Sensor for measuring yield (optional)
LEG/BYP	Legionella protection pump or electric heater cartridge
Sp1	Cylinder sensor 1
Sp2	Cylinder sensor 2

Table 5.5 Key for Fig. 5.7 and Fig. 5.8

Designation in hydraulic plan/wiring diagram	Components
S	Control of contactor for optional electrical heating rod
1	Mixer valve
230 V	230 V main power connection
F1 (T4)	Fuse holder
VC/VK	Heater wiring area

Table 5.5 Legend for Fig. 5.7 and Fig. 5.8 (continued)



Danger!

Danger of scalding due to hot water.

The mixer valve must be installed without fail to ensure protection against scalding.

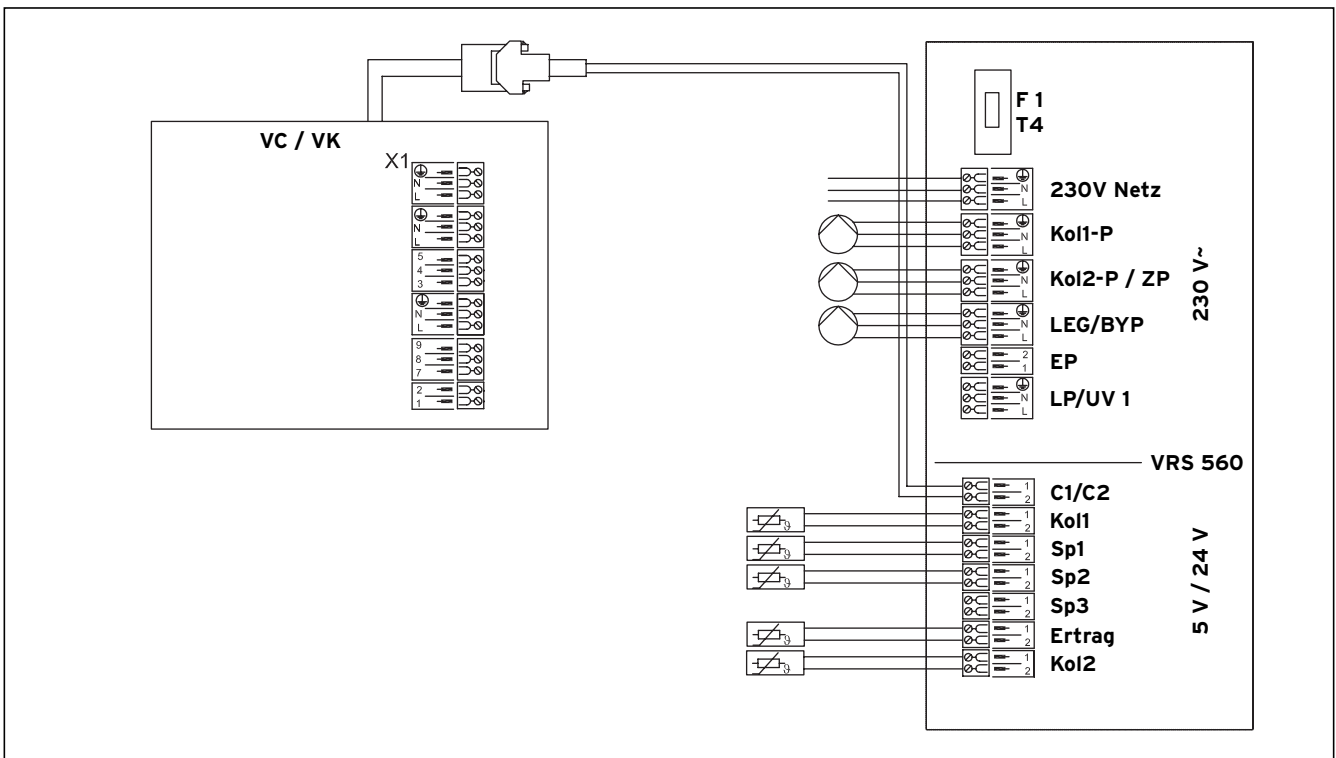

Fig. 5.8 Connection diagram for hydraulic plan 2



Note

LEG/BYP can be used as a legionella protection pump or an electric heater cartridge. Only one of these options can be used.

5 Electrical installation

Hydraulic plan 2: Connection of a second cylinder or swimming pool

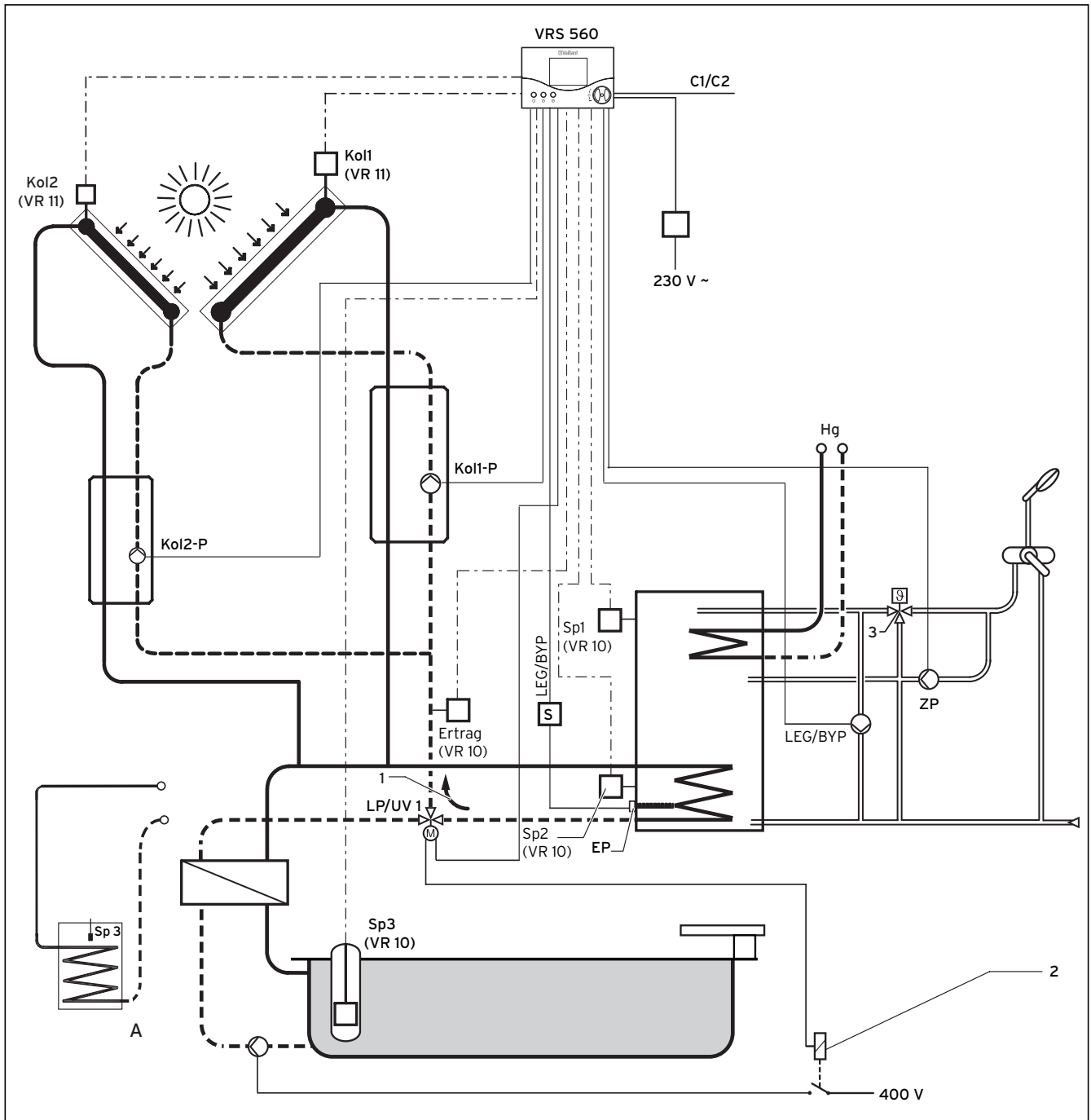

Fig. 5.9 Hydraulic plan 2: Connection of a second cylinder or swimming pool



Danger!
Danger of scalding due to hot water.
The mixer valve must be installed without fail to ensure protection against scalding.

Designation in hydraulic plan/wiring diagram	Components
C1/C2	Connections for controlling the heater used for reheating the cylinder
Hg	Boiler
EP	Electrical heating rod (optional)
SR	Swimming pool controller (provided by customer)
LP/UV 1	Diverter valve
1	LP/UV 1 diverter valve in de-energised state
A	Alternative connection for second cylinder
Kol1-P	Solar circuit pump 1
Kol2-P	Solar circuit pump 2
Kol1	Collector sensor 1
Kol2	Collector sensor 2

Table 5.6 Key for Fig. 5.9 and Fig. 5.10

Designation in hydraulic plan/wiring diagram	Components
Yield	Sensor for measuring yield (optional)
LEG/BYP	Legionella protection pump or electric heater cartridge
Sp1	Cylinder sensor 1
Sp2	Cylinder sensor 2
Sp3	Cylinder sensor 3
S	Alternative contactor or KI 3-4 (old or foreign boilers)
2	400 V connection, 3 phase
3	Mixer valve
230 V	230 V main power connection
F1 (T4)	Fuse holder
VC/VK	Heater wiring area

Table 5.6 Legend for Fig. 5.9 and Fig. 5.10 (continued)

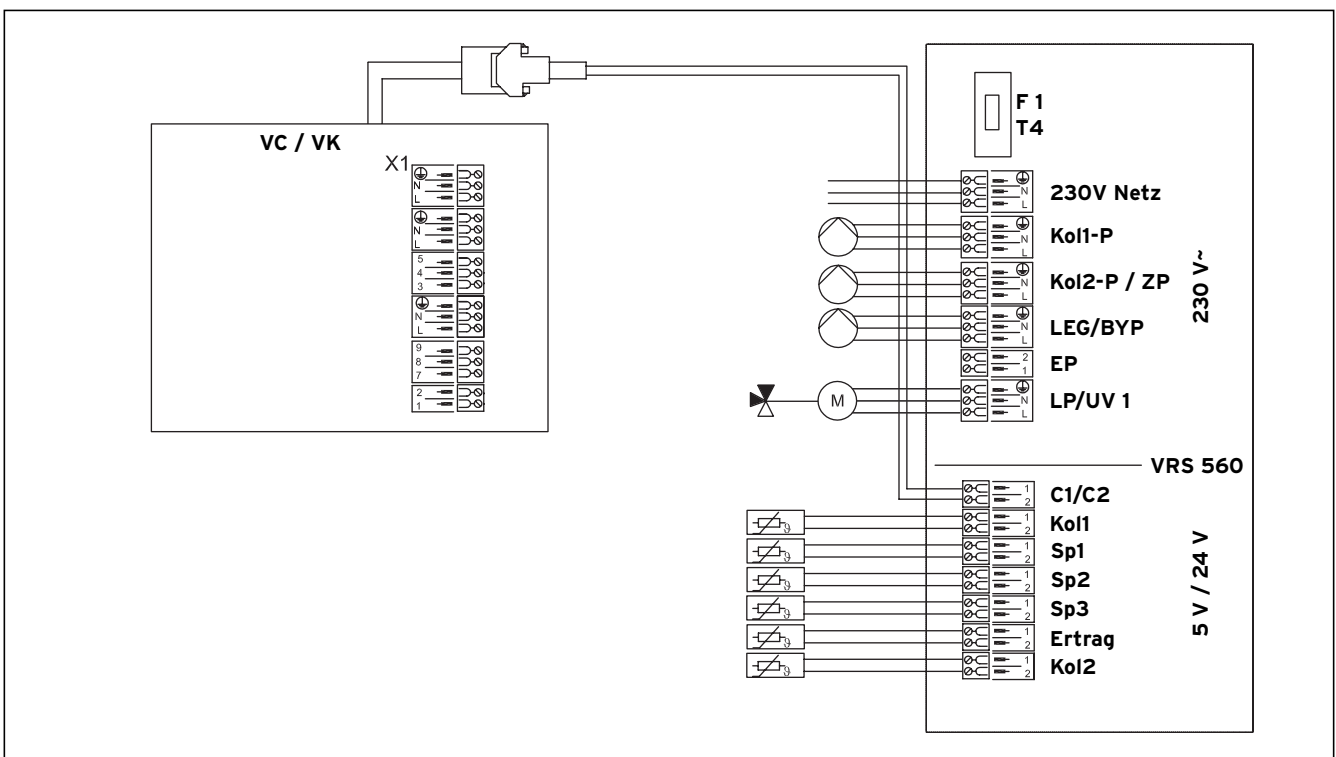

Fig. 5.10 Connection diagram for hydraulic plan 2: Connection of a second cylinder or swimming pool



Note
LEG/BYP can be used as a legionella protection pump or an electric heater cartridge. Only one of these options can be used.

5 Electrical installation

5.4 Hydraulic plan 3

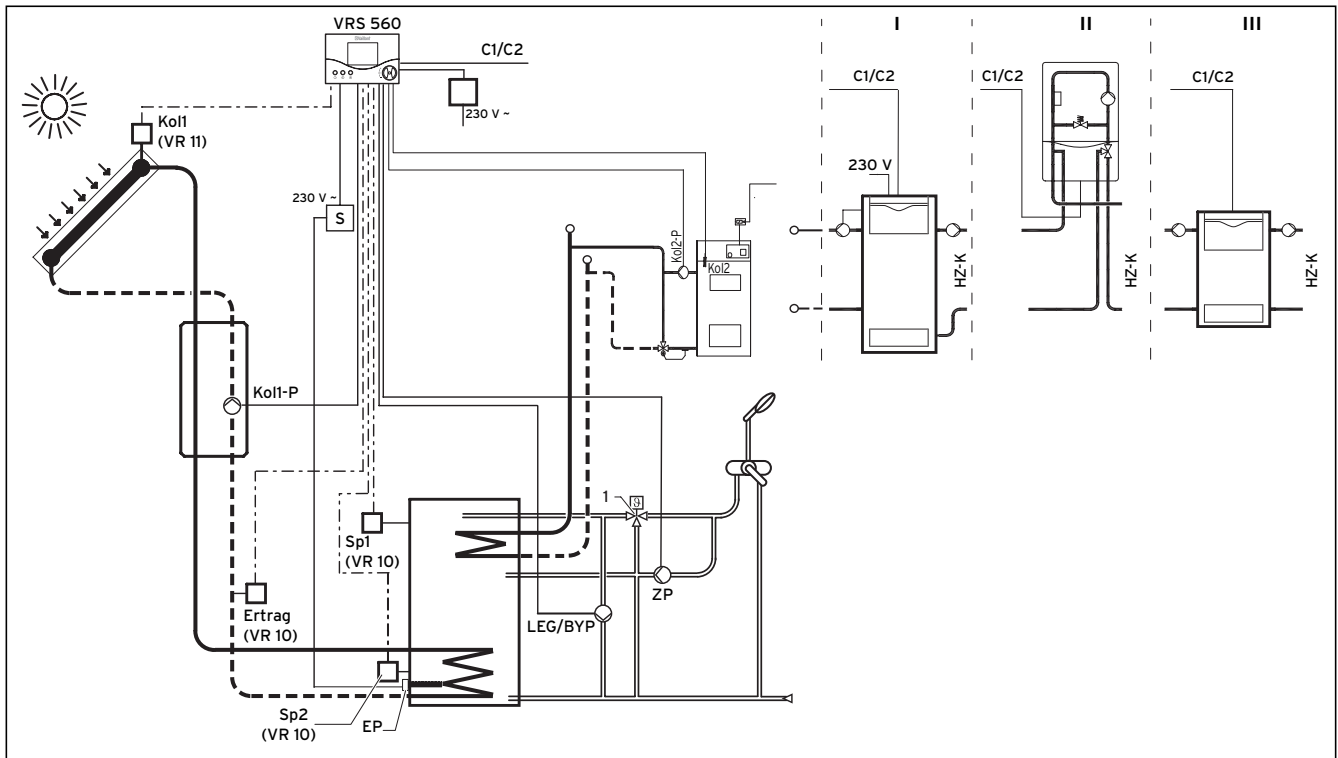

Fig. 5.11 Hydraulic plan 3 with system configuration: One collector field, one solid-fuel boiler, one solar cylinder, connection option for various heaters for reheating the cylinder

Designation in hydraulic plan/wiring diagram	Components
I, II, III	Connection option for various heaters for reheating the cylinder
C1/C2	Connections for controlling the heater used for reheating the cylinder
HZ-K	Heating circuit(s)
KW	Cold water
EP	Electrical heating rod (optional)
Kol1-P	Solar circuit pump 1
Kol1	Collector sensor 1
Kol2-P/ZP	Reheating pump 2
Kol2	Reheating sensor 2
Yield	Sensor for measuring yield (optional)
LEG/BYP	Legionella protection pump or electric heater cartridge
Sp1	Cylinder sensor 1
Sp2	Cylinder sensor 2
S	Control of contactor for optional electrical heating rod
1	Mixer valve

Table 5.7 Key for Fig. 5.11 and Fig. 5.12

Designation in hydraulic plan/wiring diagram	Components
230 V	230 V main power connection
F1 (T4)	Fuse holder
VC/VK	Heater wiring area

Table 5.7 Legend for Fig. 5.11 and Fig. 5.12 (continued)



Danger!
Danger of scalding due to hot water.
The mixer valve must be installed without fail to ensure protection against scalding.

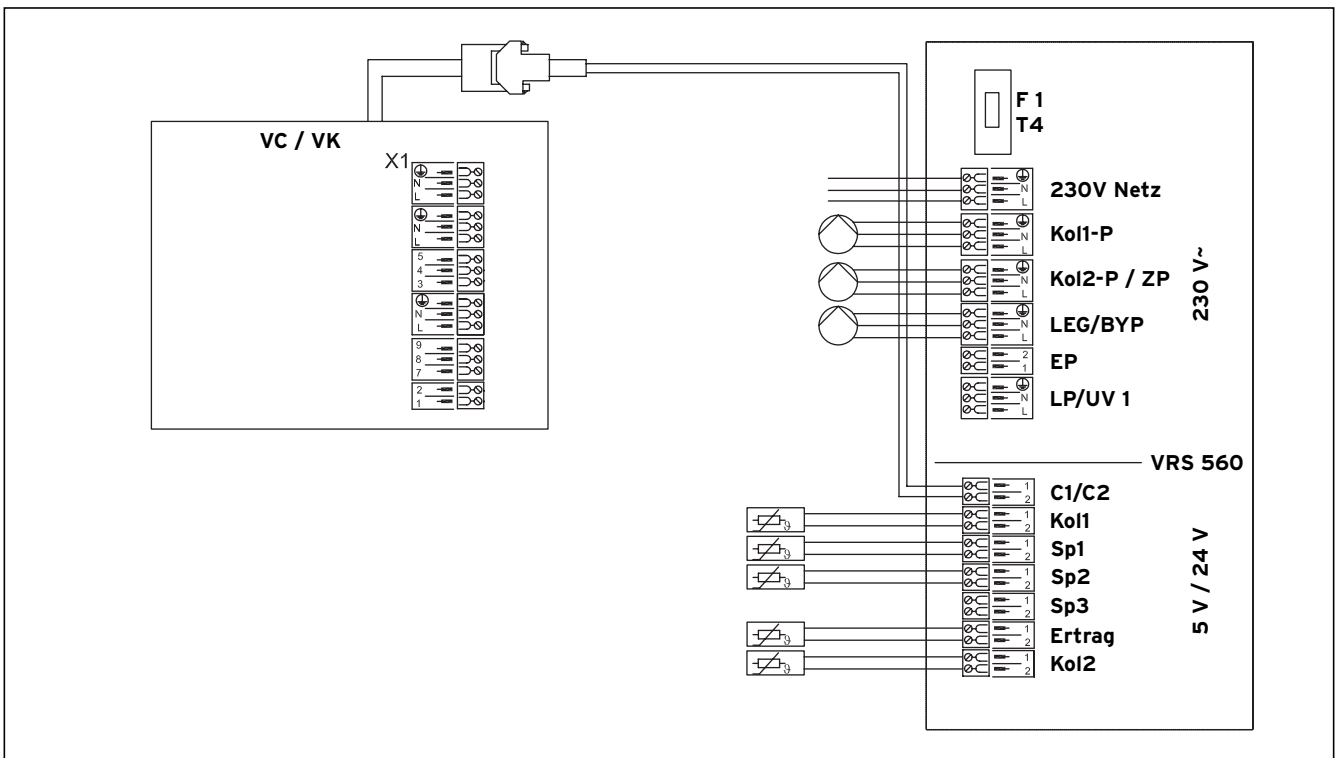

Fig. 5.12 Wiring diagram for hydraulic plan 3



Note

LEG/BYP can be used as a legionella protection pump or an electric heater cartridge. Only one of these options can be used.

5 Electrical installation

Hydraulic plan 3: Connection of a second cylinder or swimming pool

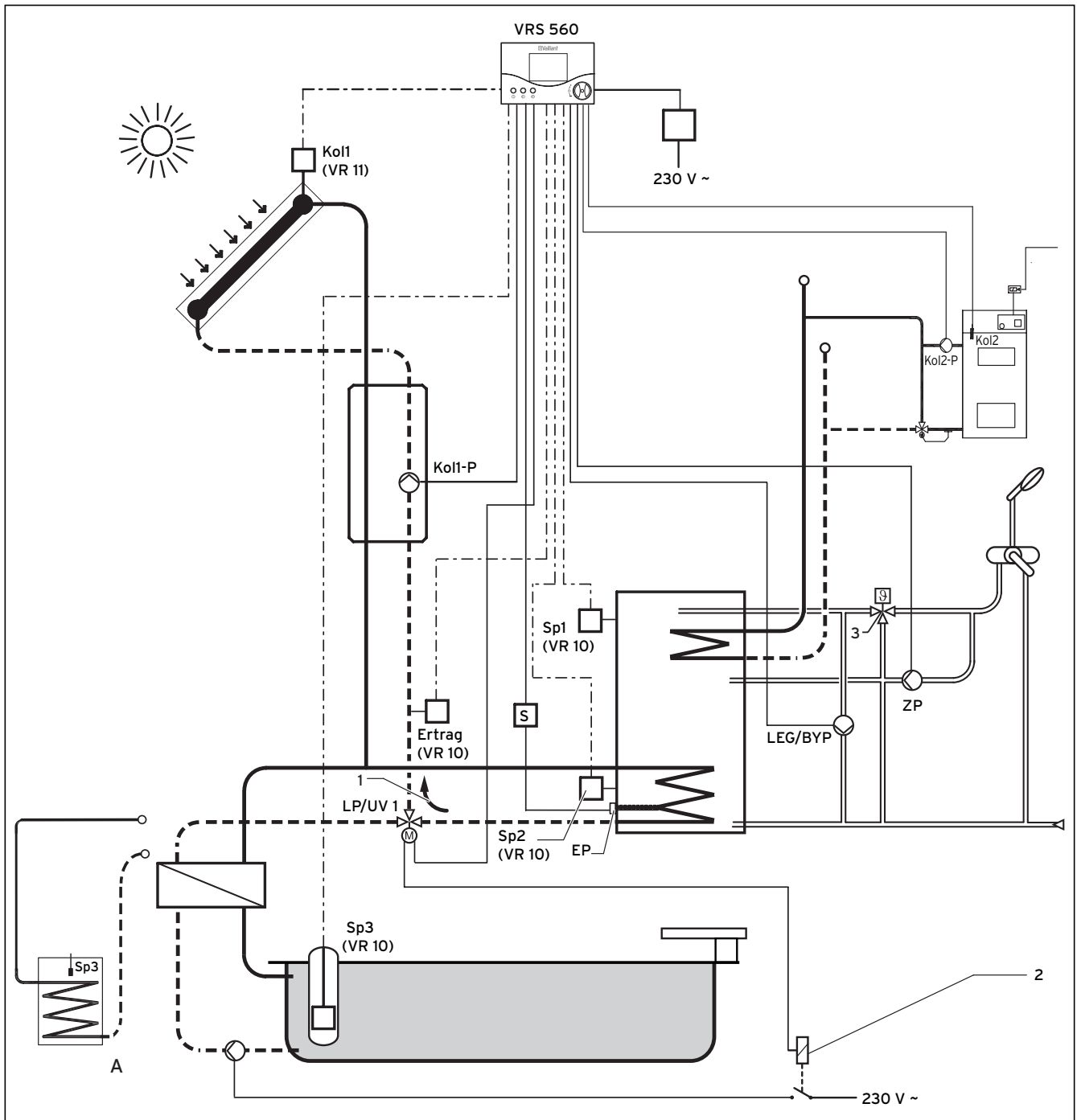

Fig. 5.13 Hydraulic plan 3: Connection of a second cylinder or swimming pool



Danger!
Danger of scalding due to hot water.
The mixer valve must be installed without fail to ensure protection against scalding.

Designation in hydraulic plan/wiring diagram	Components
C1/C2	Connections for controlling the heater used for reheating the cylinder
HZ-K	Heating circuit
KW	Cold water
EP	Electrical heating rod (optional)
SR	Swimming pool controller (provided by customer)
LP/UV 1	Diverter valve
1	LP/UV 1 diverter valve in de-energised state
A	Alternative connection for second cylinder
Kol1-P	Solar circuit pump 1
Kol1	Collector sensor 1
Kol2-P/ZP	Reheating pump 2
Kol2	Reheating sensor 2

Table 5.8 Key for Fig. 5.13 and Fig. 5.14

Designation in hydraulic plan/wiring diagram	Components
Yield	Sensor for measuring yield (optional)
LEG/BYP	Legionella protection pump or electric heater cartridge
Sp1	Cylinder sensor 1
Sp2	Cylinder sensor 2
Sp3	Cylinder sensor 3
S	Control of contactor for optional electrical heating rod
2	400 V connection, 3 phase
3	Mixer valve
230 V~	230 V main power connection
F1 (T4)	Fuse holder
VC/VK	Heater wiring area

Table 5.8 Legend for Fig. 5.13 and Fig. 5.14 (continued)

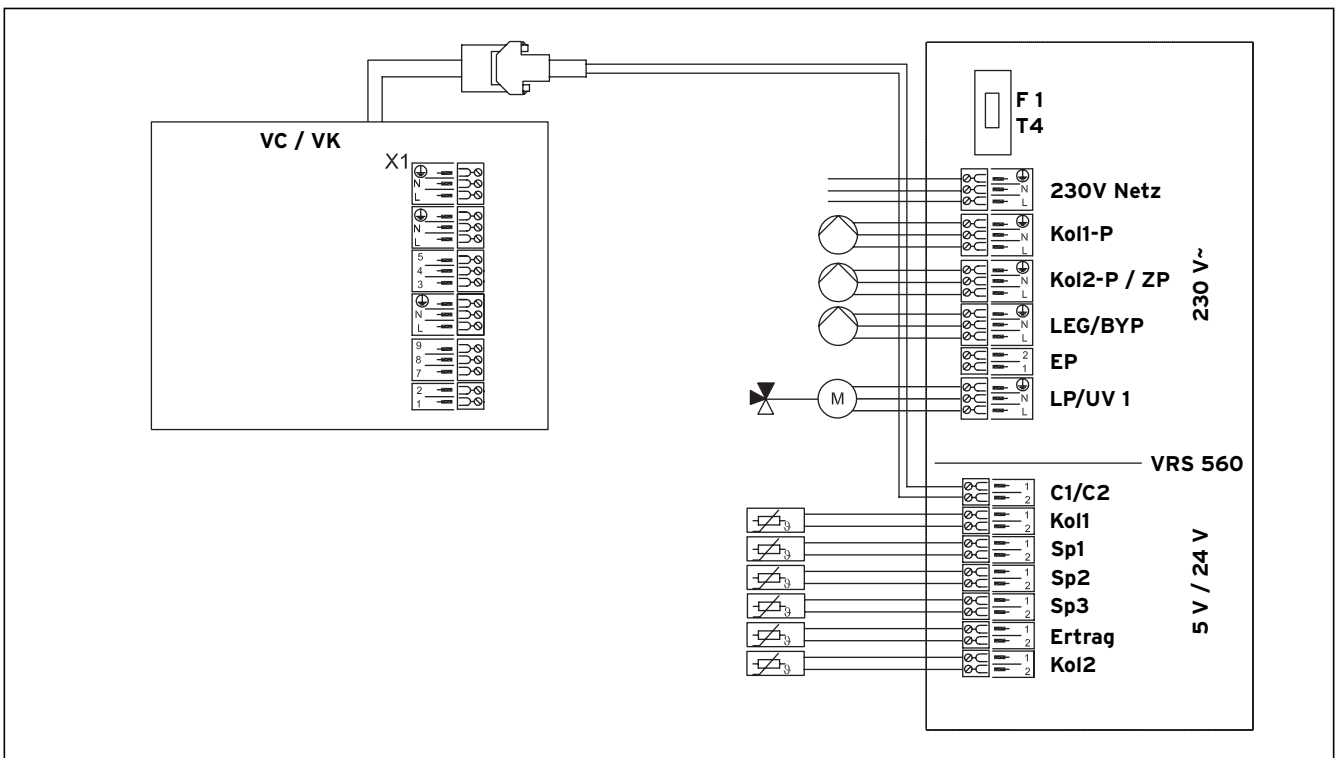

Fig. 5.14 Connection diagram for hydraulic plan 3: Connection of a second cylinder or swimming pool



Note
LEG/BYP can be used as a legionella protection pump or an electric heater cartridge. Only one of these options can be used.

6 Start-up

6 Start-up

6.1 Setting system parameters

Certain system parameters have to be set in order to optimise the system for the respective conditions. These parameters are all together on one operating level and should only be set by the heating engineer. You can access this operation level by pressing the programming button "P" for roughly 3 seconds.

All system parameters can then be called up consecutively by clicking the dial. You can specify the required values by turning the dial. The value set can be saved by clicking the dial.

When you press the P button, the display returns to basic operating level without saving the adjusted value. The following table gives an overview of all system parameters and their factory settings:

Display	Turn the dial to adjust	Setting range	Factory setting
	Changing the hydraulic plan	1, 2, 3	1
	Adjusting the flow rate in l/min. Transfer the value set at the solar station flow rate limiter taking the unit used by this specific flow rate limiter into account!	0 -165 l/min	3.5 l/min
	Resetting the solar yield. The solar yield is reset to 0 by turning the dial to 1.	-	-
	Resetting the operating hours. The operating hours are reset to 0 by turning the dial to 1.	-	-
	Setting the max. temperature for cylinder 1	20 to 90 °C	75 °C

Table 6.1 System parameters



Caution!

The maximum permissible temperature of the cylinder used (MAXT 1) must not be exceeded.

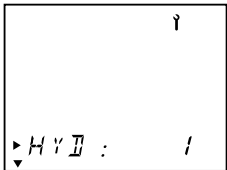
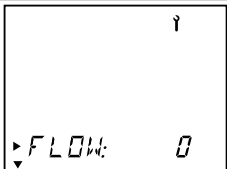
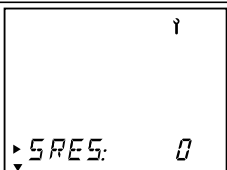
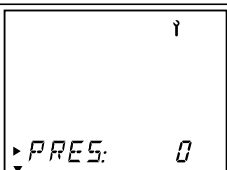
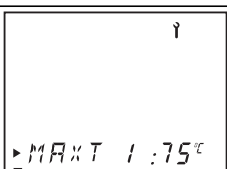
Display	Turn the dial to adjust	Setting range	Factory setting
	Setting the activation difference for cylinder 1 (The activation difference should always be 2 K greater than the deactivation difference)	2 - 25 K	7 K
	Setting the deactivation difference for cylinder 1 (The deactivation difference should always be 2 K less than the activation difference)	1 - 20 K	3 K
	Setting the max. temperature for cylinder 2	20 - 90 °C	60 °C

Table 6.1 System parameters (continued)

**Caution!**

The maximum permissible temperature of the cylinder used (MAXT 2) must not be exceeded.

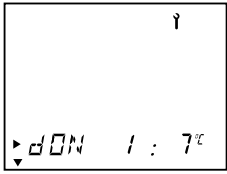
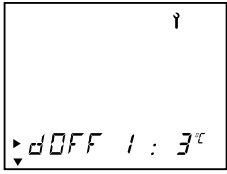
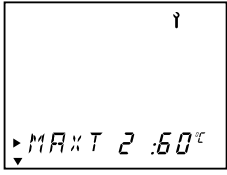

Display	Turn the dial to adjust	Setting range	Factory setting
	Setting the activation difference for cylinder 2 (The activation difference should always be 2 K greater than the deactivation difference)	2 - 25 K	7 K
	Setting the deactivation difference for cylinder 2 (The deactivation difference should always be 2 K less than the activation difference)	1 - 20 K	3 K
	PRIO Cylinder with highest priority	1, 2	1
	FROS: Frost protection function	-5 °C - 10 °C; OFF	OFF

Table 6.1 System parameters (continued)

6 Start-up



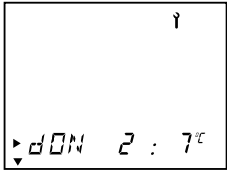
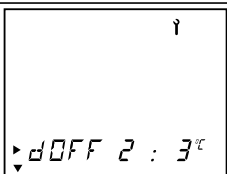



Display	Turn the dial to adjust	Setting range	Factory setting
	PROT Solar circuit protection function	OFF, 110 °C - 150 °C	130 °C
	KOLT: Collector type 1 = flat collector 2 = tube collector	1, 2	1
	LEG Anti-legionella function	OFF, 1, 2, 3, 4, 5, 6, 7, 1-7 1 = Monday 2 = Tuesday 3 = Wednesday 4 = Thursday 5 = Friday 6 = Saturday 7 = Sunday	OFF
	LEGT: Start time, anti-legionella function	00:00 - 23:50	04:00
	Activating the reheating delay function	0=deactivated; 1=activated	0
	Activating duration controlling	0=off; 1=on	0
	Setting the current day	1-31	0
	Setting the current month	1-12	0
	Setting the current year	2000-2159	2000

Table 6.1 System parameters (continued)

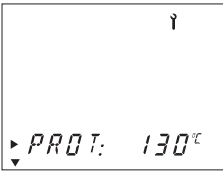
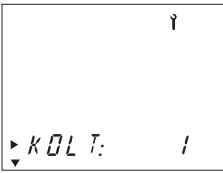
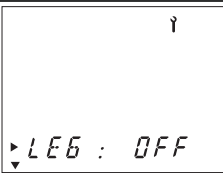
6.2 Resetting the system parameters to the default setting

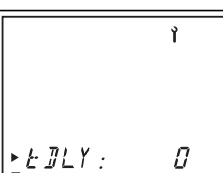
You can restore the default settings for system parameters and timer programs by pressing the programming button "P" for roughly ten seconds. Then the display flashes three times and all of the parameters are reset to the factory defaults.

7 Service/diagnostics

You can access the service/diagnostics level by pressing the programming button "P" and the dial simultaneously (for roughly 3 seconds).

Display	Actuators/sensor values	Test procedure
	Collector pump 1 test	Collector pump 1 on, all other actuators off
	Collector pump 2 test or circulation pump test (for hydraulic plan 1)	Collector pump 2 on, all other actuators off
	Diverter valve test	Diverter valve on, all other actuators off
	Anti-Legionnaires' pump test	Anti-Legionnaires' pump on, all other actuators off
	Electrical heating rod (EP) test	Electrical heating rod (EP) test on, all other actuators off
	C1/C2 contact test	C1/C2 contact closed, all other actuators off

Table 7.1 Actuators and sensors

7 Service/diagnostics

Display	Actuators/sensor values	Test procedure
	Cylinder temperature display for cylinder sensor 1	
	Cylinder temperature display for cylinder sensor 2	
	Temperature display for cylinder sensor 3	
	Temperature display for collector sensor 1	
	Temperature display for collector sensor 2	
	Temperature display for return flow (yield sensor)	

Table 7.1 Actuators and sensors (continued)

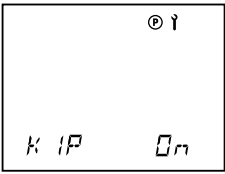
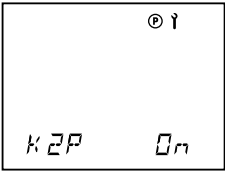
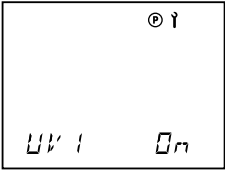
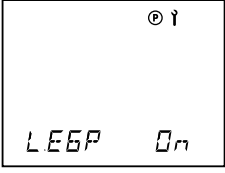
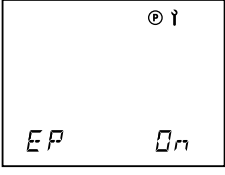
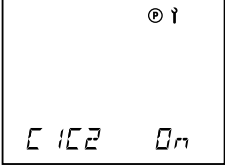
You can check the visual display by clicking on the dial again.

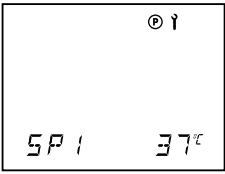
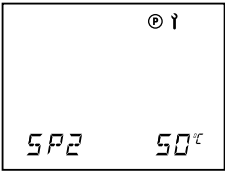
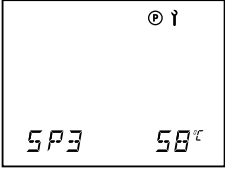
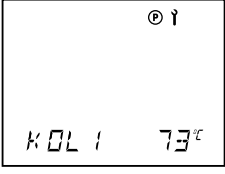
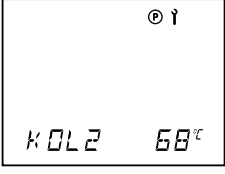
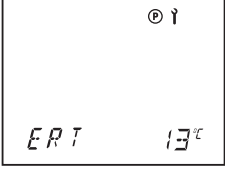
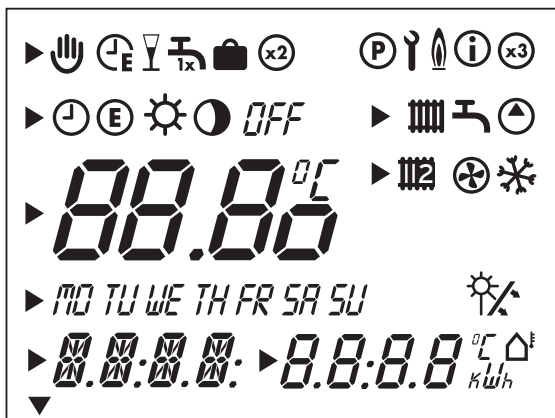

Fig. 7.1 Check visual display

With another click, the current version of the controller's software is displayed.

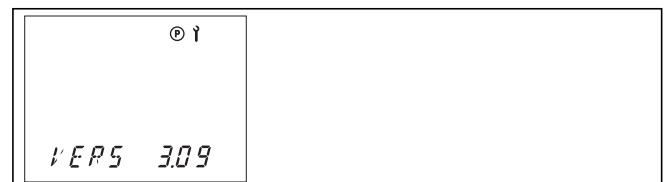

Fig. 7.2 Controller software version

You can exit the service/diagnostic level by pressing the programming button.

8 Emergency mode

When the auroMATIC 560 detects an error, its basic display always shows the error. If either the solar yield or reheating function is possible, the controller carries out this function in spite of the error.

9 Technical data

Features	Units	auroMATIC 560
Operating voltage	V AC/Hz	230/50
Controller current consumption	W	max. 10
Contact load of output relays (max.)	A	2
Maximum total current	A	4
Shortest switching interval	min	10
Power reserve	min	30
Maximum ambient temperature	°C	50
Sensor operating voltage	V	5
Minimum cross-sections		
Sensor wires	mm ²	0,75
230 V power wires	mm ²	1,5
Controller housing dimensions		
Height	mm	175
Width	mm	272
Depth	mm	55
Level of protection		IP 20
Protection class for controller		II

Table 9.1 Technical data

10 Sensor characteristics

VR 10 standard sensor, type NTC 2.7 K

Sensor values	Resistance value
0 °C	9191 Ohm
5 °C	7064 Ohm
10 °C	5214 Ohm
20 °C	3384 Ohm
25 °C	2692 Ohm
30 °C	2158 Ohm
40 °C	1416 Ohm
50 °C	954 Ohm
60 °C	658 Ohm
70 °C	463 Ohm
80 °C	333 Ohm
120 °C	105 Ohm

Table 10.1 Characteristics of VR 10 standard sensor

VR 11 standard sensor, type NTC 10 K

Sensor values	Resistance value
-20 °C	97070 Ohm
-10 °C	55330 Ohm
-5 °C	42320 Ohm
0 °C	32650 Ohm
5 °C	25390 Ohm
10 °C	19900 Ohm
15 °C	15710 Ohm
20 °C	12490 Ohm
25 °C	10000 Ohm
30 °C	8057 Ohm
35 °C	6532 Ohm
40 °C	5327 Ohm
50 °C	3603 Ohm
60 °C	2488 Ohm
70 °C	1752 Ohm
80 °C	1258 Ohm
90 °C	918 Ohm
100 °C	680 Ohm
110 °C	511 Ohm
120 °C	389 Ohm
130 °C	301 Ohm

Table 10.2 Characteristics of VR 11 standard sensor

11 Vaillant Service

To ensure regular servicing, it is strongly recommended that arrangements are made for a Maintenance Agreement. Please contact Vaillant Service Solutions (0870 6060 777) for further details.

Vaillant Ltd

Vaillant House ■ Medway City Estate ■ Trident Close ■ Rochester ■ Kent ME2 4EZ
Telephone 01634 292300 ■ Fax 01634 290166 ■ www.vaillant.co.uk ■ info@vaillant.co.uk

0020008427_01 GB 042008