



Products with this symbol (crossed out wheeled bin) cannot be disposed as household waste. Old electrical and electronic equipment must be recycled at a facility capable of handling these products and their waste by-products. If you are purchasing replacement equipment your retailer may offer a 'take back' scheme, or will be able to give details of the nearest approved authorised treatment facility. Proper recycling and waste disposal will help conserve resources whilst preventing detrimental effects on our health and the environment.

WEEE Registered Code: WEE/ED0093VW

*This appliance is not intended for use by persons (including children) with reduced physical, sensory or mental capabilities, or lack of experience and knowledge, unless they have been given supervision or instruction concerning use of the appliance by a person responsible for their safety. Children should be supervised to ensure that they do not play with the appliance.*



Approved CQS ISO 9000:2008



Smith's Environmental Products Ltd,

Blackall Industrial Estate, South Woodham Ferrers, Chelmsford, Essex, CM3 5UW

Tel: 01245 324900 Fax: 01245 324422

Sales E-mail: sales@smiths-env.com General Information E-mail: info@smiths-env.com Web: www: smiths-env.com

For Ireland, contact MT Agencies (Ireland) Ltd on Tel: 00353 1 844 3212

As part of the policy of continuous product improvement, Smith's Environmental Products Ltd reserves the right to alter specification without prior notice.

# SS5 /12V

# Space Saver

## Installation and User Guide

### Discover the hidden benefits

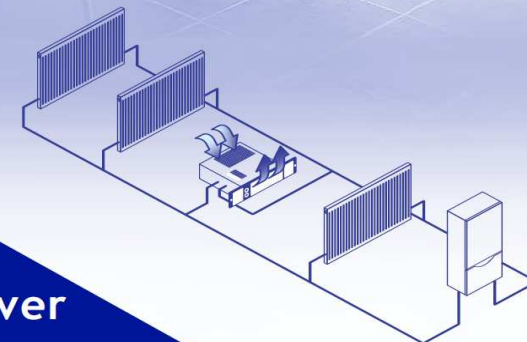

## Space Saver

The following items should be included in the carton:

- ❖ Product complete with steel grille.
- ❖ Transformer with 450mm of pre-wired mains cable.
- ❖ Two single-pin male connectors.
- ❖ Fixing screws (2).
- ❖ One pair flexible installation hoses.

Accessory grilles which fit in place of the standard grille are available in different colours and finishes. Please consult the price list for details. In the event of any items missing or visible damage, please contact us on 01245 324560.

We would be most grateful if you would leave this Installation & User Guide and the Guarantee Registration Card with the owner of the property.

.....

.....

.....

.....

.....

.....

.....

.....

.....

.....

.....

.....

.....

.....

.....

.....

.....

.....

.....

.....

.....

.....

Space Saver 12-volt models are primarily intended for installation in the space beneath bathroom cabinets, bath panels and other high humidity areas. 12-volt models are safe to operate with wet hands.

Space Saver is designed for use on standard two-pipe pumped central heating systems. Pipes are 15mm and either may be used as flow or return. This product is not suitable for one-pipe systems.

The transformer must be located outside the bathroom or high humidity area. The 450mm lead attached to the transformer must be connected to the fused spur (mains supply).

You will need to provide a cable (twin core 0.5mm<sup>2</sup> for lengths of up to 6 metres, 1.0mm<sup>2</sup> for longer lengths) to connect the terminals on the product to the transformer. The two single-pin male connectors are provided to connect this cable to the transformer terminals.

Space Saver is classified as a fixed appliance and electrical connection should be via a double pole 3A fused spur with a minimum contact gap of 3mm.

The fused spur should be close to the transformer and must be accessible after completion of the installation. This product must not be earthed.

To ensure adequate airflow, a minimum clearance of 20mm between the top of the product and any shelving is essential. To avoid the possibility of vibration, this product must be installed on a flat even surface. There must be no rear access to the product after completion of the installation.

To conform to Building Regulation Part L (Part J in Scotland), a remote room thermostat (Smith's Part No. RT002) can be used in conjunction with this Space Saver fan convector.

The flexible installation hoses supplied are suitable for use with either 15mm diameter copper pipe or 15mm cross-linked polythene barrier pipe to BS7291. For all other types of pipe we recommend the use of compression type fittings.

Please note the guarantee may be invalidated if this product is not installed and used in accordance with this guide.

In line with best practice, isolating valves (not supplied) must be fitted to the system flow and return pipes. Failure to fit isolating valves may mean that the product is not serviceable in the event of failure.

# User Guide

## SS5 /12V

### User Information

- ❖ Your product is covered by a **free 5-year and labour guarantee**; please complete and return the Guarantee Registration Card to us as soon as possible to ensure that should you require assistance, we can help you quickly and more efficiently.
- ❖ Your Space Saver fan convector is designed to operate as part of your central heating system in the same way as a panel radiator. Providing the lower heat output switch is left in either the normal (I) or boost position (II) and the upper switch is in the HEATING position your Space Saver will switch on and off automatically with your central heating system.

### How your Space Saver fan convector works

Hot water from your central heating system passes through a heat exchanger transferring its heat to the aluminium fins. Cooler air is drawn in by the fan and heated as it passes through the heat exchanger before being discharged gently back into the room. This not only gives a more even temperature spread, but will use around 25% less energy and heat up a room in less than half the time of a traditional panel radiator.

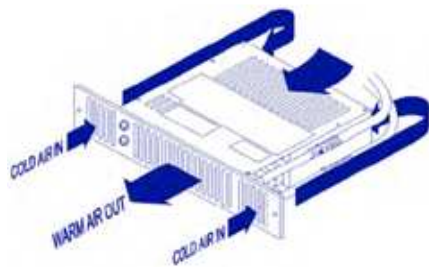

Space Saver includes an internal thermostat that prevents the fan from operating until the central heating system water passing through the heat exchanger reaches 38° C. This prevents the Space Saver circulating cooler air at start up.

### Heating

Ensure your central heating system is on, the lower switch set to normal and the upper switch to heating RED. Providing the water temperature in the system is more than 38° C and the thermostat controlling your central heating system is calling for heat, your Space Saver will switch on.

If you require a faster warm up, move the lower switch to boost (II). Moving the switch to (O) will turn off the Space Saver.

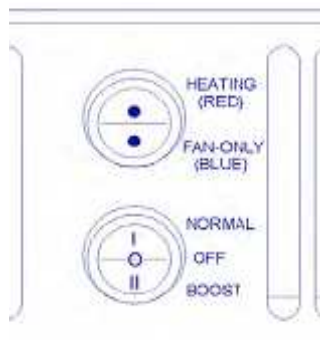

### Air Circulation (Summer Use)

Ensure your central heating system is off. Set the upper switch to BLUE and the lower switch to (I) or (II). Space Saver will run to provide a cooling flow of air. If used in conjunction either a remote room thermostat, ensure the thermostat is set to maximum.

### Fault Finding

This Space Saver is covered by a free 5-year parts and labour guarantee. Please refer to the Fault Finding section on page 5 for advice. In the event of difficulty, please contact us on 01245 324560. It will be helpful if you do not disconnect the Space Saver from your central heating system.

## Installation Guide

1. We recommend the use of a knee pad when installing this product.

Cut the opening in the plinth to the size shown in the table. Use method A or B.

| Model    | Width A | Height B* |
|----------|---------|-----------|
| SS5 /12V | 475mm   | 96mm      |

\* The overall height of the grille is 100mm. Use care when cutting the opening.

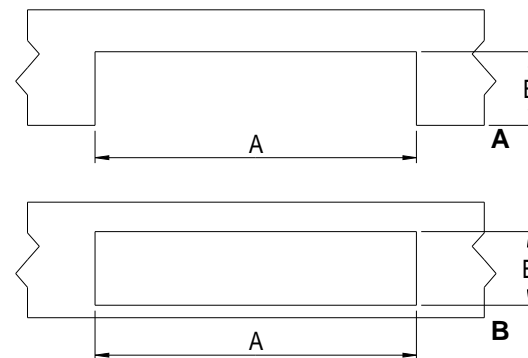

2. Fit isolating valves (not supplied) to the system flow and return pipes. Failure to fit isolating valves may mean that the product is not serviceable in the event of failure. Connect the flexible hoses between system pipework and heater. Open the isolating valves and check for leaks.

N.B. either pipe may be used on flow or return.

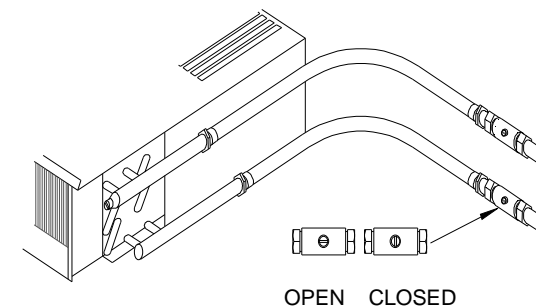

3. Vent air through bleed

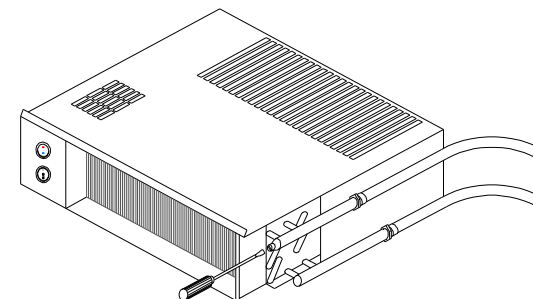

4. Isolate electrical supply and connect the transformer flying leads to the fused spur (3A). The transformer must be located outside the bathroom or high humidity area. Connect the single-pin male connectors to the twin core cable you have supplied.

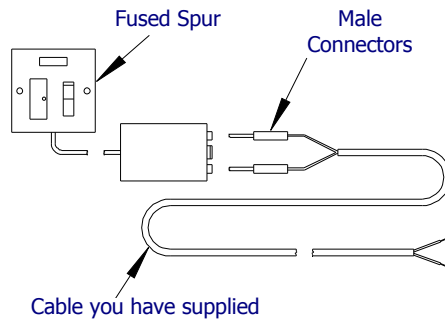

5. Push in the connectors to the transformer terminals and connect the other end of the cable to the terminals on the back of the product.

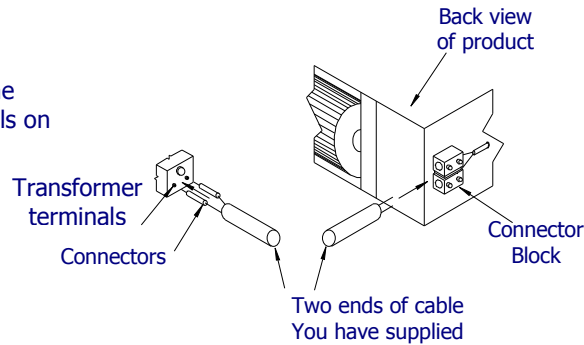

## Commissioning

1. Turn on the electrical supply at the fused spur.
2. Set the upper control switch on the fascia grille to BLUE and the lower switch to either I or II. The fan will run.
3. Turn on the central heating system.
4. Set any room thermostat/s to maximum.
5. Set the lower heat output switch to I and the upper switch to RED – the fan should run and heat will flow within a few minutes.
6. Balance the central heating system if Space Saver is installed on the same circuit as panel radiators.
7. When the installation is working correctly, remember to reset any room thermostat/s to its normal setting

6. Position heater, making sure the flexible hoses are not kinked and the electrical cable is not snagged.

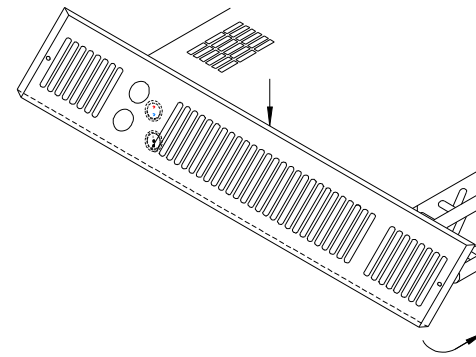
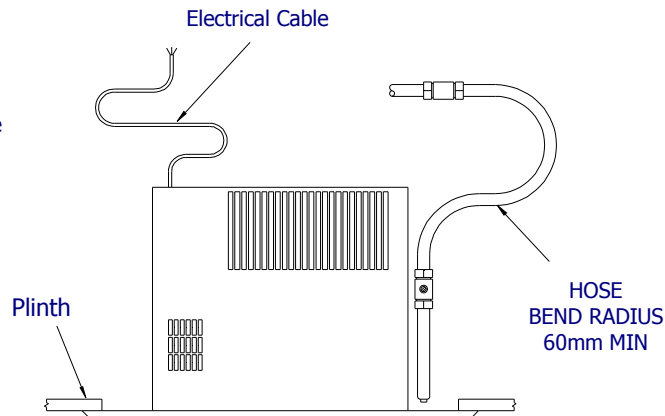

7a. Fit supplied grille over top flange, locate over switches then press lower edge backwards, as shown in diagram, to fix grille in place.

7b. Fix assembled heater to plinth using fixing screw holes located at either end of grille.

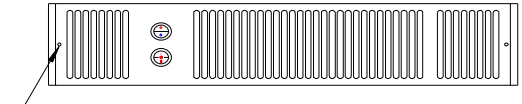

Grille to plinth securing screws

## Heat Output Performance

It is recommended that the Space Saver model chosen is capable of maintaining the calculated heat loss at normal heat output (I) enabling the boost setting (II) to be used for faster heat up.

| Model    | Heat Output $\Delta t$ 60°C |            | Heat Output $\Delta t$ 50°C |            |
|----------|-----------------------------|------------|-----------------------------|------------|
|          | Normal (kW)                 | Boost (kW) | Normal (kW)                 | Boost (kW) |
| SS5 /12V | 1.3                         | 1.7        | 1.1                         | 1.4        |

Notes:

$\Delta t$  60°C assumes a mean water temperature of 80°C and room temperature of 20°C.  
 $\Delta t$  50°C assumes mean a water temperature of 70°C and room temperature of 20°C.

## Fault Finding

1. Fan does not run on any switch setting.
  - a). Check the power supply is switched ON.
  - b). Check fuse in fused spur.
  - c). Check the wiring connections at the fused spur.
2. No heat output on settings I and II.
  - a). Check the power supply is switched ON.
  - b). If fitted, ensure any room thermostats are calling for heat.
  - c). Balance the central heating system if installed on same circuit as panel radiators and increase the circulating pump speed if required.
  - d). Increase the boiler water temperature.

In the event of any difficulty, please contact us on 01245 324560.  
 It will be more helpful if you do not remove the product from the central heating system.