

**protherm**



# ***Thermolink RC***

## **Instructions for Use Installation and Servicing**

- **Version eBUS**
- **Wireless communication**
- **Setting heating temperature „Comfort“ and „Eco“, DHW**
- **Possibility equithermal regulation**
- **Selecting with or without modulating**
- **Daily or weekly programming**
- **Holiday“ function, temporary override, frost protection**

**EN**  
version **CE**

0020041352 - v.0 1/2008

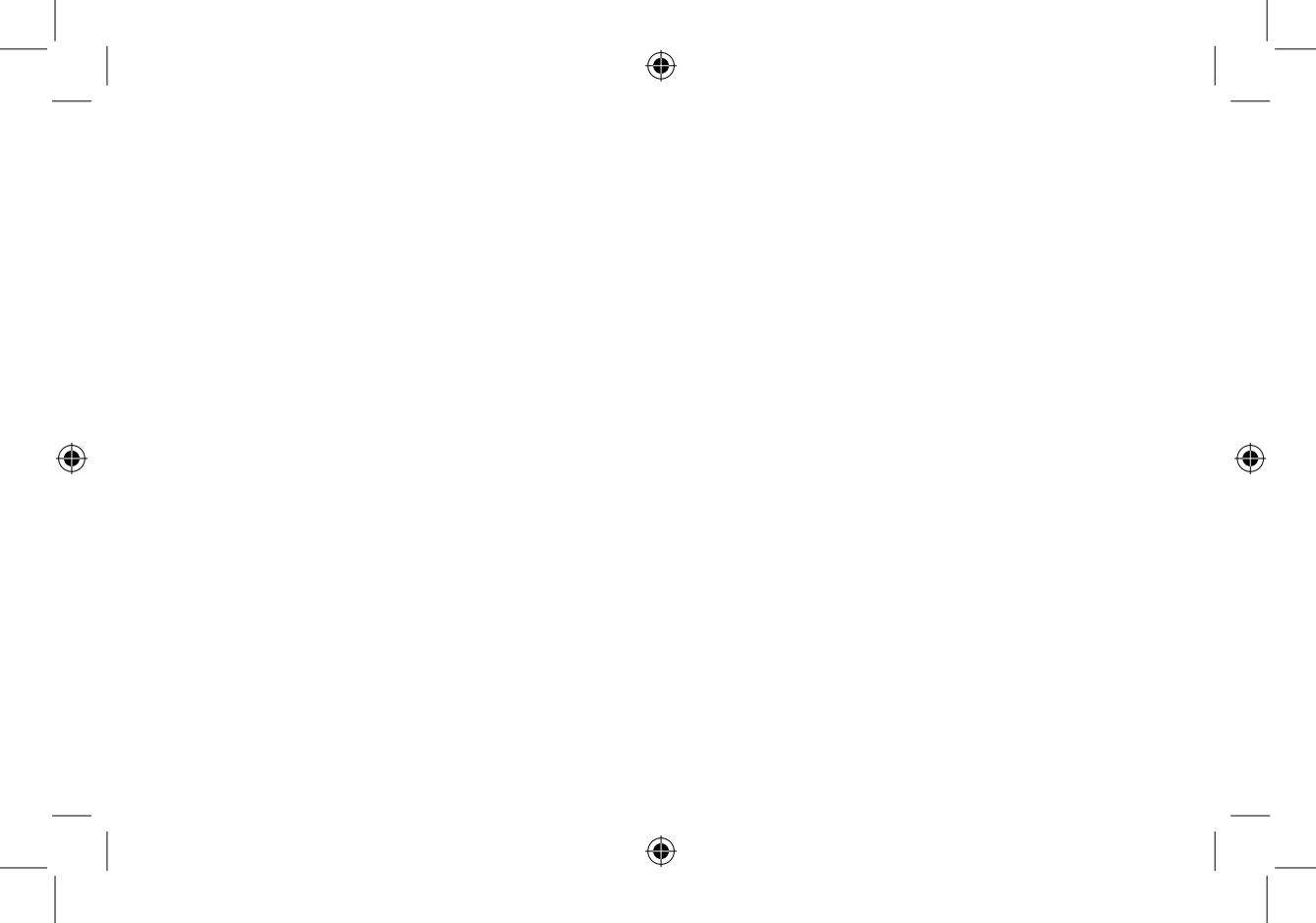

# Instructions for Use

## Index

1	General .....	2	8.4	General display screens .....	9
2	Documentation.....	2	8.5	Operating mode selection .....	9
3	Warranties / Responsibility .....	3	8.6	Setting heating temperature .....	11
4	Thermostat use .....	4	8.6.1	“Comfort” heating temperature... ..	11
5	Thermostat maintenance.....	5	8.6.2	“Eco” heating temperature .....	12
6	Recycling .....	5	8.6.3	Setting hot water temperature ... ..	13
7	Kit contents .....	5	8.7	“Holiday” function .....	14
8	Thermostat use .....	6	8.8	Setting the time and date.....	15
8.1	Front cover .....	6	8.9	Week heating program .....	16
8.2	Description of Display .....	7	8.10	Hot water heating weekly program ..	20
8.3	Description of buttons .....	7	8.11	Temporary override.....	24
			8.12	Information menu .....	27
			8.13	Výměna baterií .....	28
			9	Troubleshooting .....	30
			10	Frost protection.....	33



## 1 General

Thermolink RC is a wireless weekly programmable room thermostat which enables setting heating comfort according to your needs at selected time intervals. This unit also allows also setting the hot water heating time.

This thermostat includes an integrated device for temperature modulation based on required room temperature.

The installation and commissioning of the appliance has to be carried out by a qualified electrician according to connection diagrams and in compliance with respective safety regulations.

To achieve class II protection, appropriate installation measures must be taken accor-

ding to directive VDE 0100. This independently installed appliance is used to control temperature exclusively in dry rooms with a standard atmosphere.

Use the services of an authorized installation and service company for maintenance and service purposes.

## 2 Documentation

- Please keep this manual safe for future reference.

The manufacture shall not be liable for unprofessional use of the appliance contrary to this manual, and in case of a defect for such reasons the manufacture shall not be liable for any damages.





### 3 Warranty / Responsibility

Your appliance is guaranteed for a period of 24 months from the date of sale. The manufacture shall accept only defects in materials and workmanship.

- The appliance was installed by a qualified professional in accordance with installation instructions, and all the relevant codes of practice, standards and legislation in force.
- The appliance has been used for in accordance with the Instructions for Use.
- The control has not been serviced, maintained, repaired dismantled or



tampered with during the guarantee period, by anyone other than a competent person.

The warranty does not cover:

- any defects or damage resulting from incorrect or poor installation.
- Any defects in the system to which the appliance is connected.
- Any deterioration or maladjustment following changes in the characteristics of the electrical supply voltage.

Notification of any fault should be made to the control installer. No repairs should be undertaken upon the control, intending





it to be covered by the product guarantee without prior authorisation from the manufacturer.

#### **4 Thermostat use**

This appliance is a programmable room thermostat designed for controlling heating equipment. Depending on room temperature and the set heating program, it cuts heating costs.

Any other use is regarded as inappropriate and prohibited.



This appliance is a programmable room thermostat designed for controlling heating equipment. Depending on room temperature and the set heating program, it cuts heating costs.

Any other use is regarded as inappropriate and prohibited.

## 5 Thermostat maintenance

- Clean the surface of the appliance with damp soapy cloth.
- Make sure that no water gets inside the appliance.
- Do not use any abrasive cleaning product as it could damage the housing or plastic case.

## 6 Recycling

The appliance comprises many recyclable parts, like the packaging, manuals and appliance itself. At the end of the appliance's service life, do not dispose of the packaging and manuals in domestic waste

but recycle them. The appliance should be recycled as electronic waste.

## 7 Kit contents

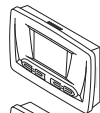

PROGRAMMABLE  
ROOM THERMOSTAT  
(CONTROLLER)

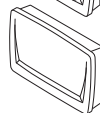

RADIO  
(RECEIVER)



FIXINGS



BATTERIES „AAA LR03“



INSTRUCTIONS FOR USE

## 8 Thermostat use

### 8.1 Front cover



**6**





## Legend

- 1 Display
- 2  Mode button
- 3  Programme button
- 4  Minus button
- 5  Plus button

## 8.2 Description of display

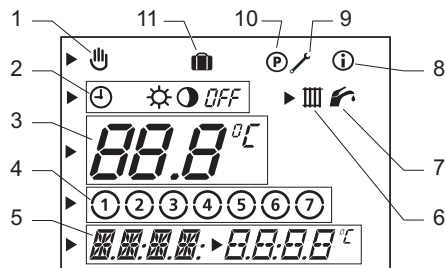

## Legend

- 1 Temporary override
- 2 Indication of operating mode
- 3 Multifunctional display zone (1)
- 4 Days of week
- 5 Multifunctional display zone (2)
- 6 Heating water heating symbol
- 7 Hot water heating symbol
- 8 Information menu symbol
- 9 Service menu symbol
- 10 Programming menu symbol
- 11 "Holiday" function symbol

## 8.3 Description of button

### 8.3.1 Button

Repeated pressing of the button  opens the following setting:



Presses	Description
1	Selection of operating mode
2	Selection of "Comfort" heating mode
3	Selection of "Eco" heating mode
4	Setting of hot water temperature
5	"Holiday" function
6	Setting the day of the week
7	Setting the time - hours
8	Setting the time - minutes
9	Setting the date (if activated)

### 8.3.2 Button

Pressing the button :

- **Repeatedly:** you can view different programs.
- **Pressing and holding the button for 5 seconds:** you can modify the heating program.

### 8.3.3 Button

Press the button  to decrease the set value.

### 8.3.4 Button

Press the button  to increase the set value.



## 8.4 General display screens

At first switch-on the display shows the general screen.

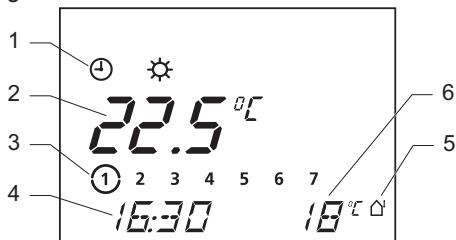

### Legend

- 1 Current operating mode
- 2 Room temperature
- 3 Current day of the week
- 4 Current time
- 5 Outside sensor presence (\*)
- 6 Outside temperature (\*)





(\*) Displayed only if an outside sensor is connected to the boiler.

Settings at the controller may take up to 50 seconds to be communicated to the boiler.

## 8.5 Operating mode selection

- To select the operating mode press the **mode** button in the general display screen. Symbol starts flashing (1).
- Use the **+** and **-** buttons to select the operating mode. The selected mode's symbol starts flashing.



Symbol	Operating mode
	<b>Automatic:</b> Depending on the set time, the thermostat switches between temperatures  and  in the heating mode.
	<b>Comfort:</b> Heating to a comfortable temperature.
	<b>Eco:</b> Heating to an economical temperature.
<i>OFF</i>	<b>Shutdown:</b> Heating is switched off. Frost protection function is still functional.

The setting is saved:

- **automatically after 10 seconds:** general display screen is shown,
- **or after pressing the mode button:** subsequent display screen is shown.



## 8.6 Setting heating temperature

### 8.6.1 Setting “Comfort” heating temperature



- Press the **(mode)** button twice in the general display screen.
- Use the **(+)** and **(-)** buttons to set the  “Comfort” temperature.

The temperature value to be set flashes.

 	Temperature (°C)
Minimum	5
Recommended	20
Maximum	30

*Instructions for Use*

The setting is saved:

- **automatically after 10 seconds:**  
general display screen is shown,
- **or after pressing the **(mode)** button:**  
subsequent display screen is shown.

## 8.6.2 Setting “Eco” heating temperature

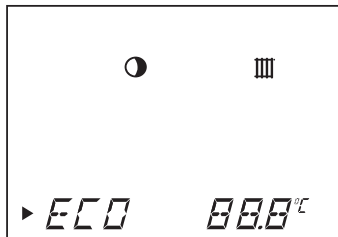

- Press the **(mode)** button three times in the general display screen.
- Use the **+** and **-** buttons to set the **●** “Eco” temperature. The temperature value to be set flashes.

<b>● ■■</b>	<b>Temperature (°C)</b>
Minimum	5
Recommended	15
Maximum	30

The setting is saved:

- **automatically after 10 seconds:** general display screen is shown,
- **or after pressing the **(mode)** button:** subsequent display screen is shown.

### 8.6.3 Setting hot water temperature



- Press the **(mode)** button four times in the general display screen.
- Use the **+** and **-** buttons to set the hot water temperature **888**.

The temperature value to be set flashes.

- **Caution:** this parameter does not affect the function of boiler used only for heating. Hot water temperature **SAN** at the hot water tank is controlled by means of an NTC sensor.

	Temperature (°C)
Minimum	38
Recommended	60
Maximum	65

The setting is saved:

- **automatically after 10 seconds:** general display screen is shown,
- **or after pressing the button (mode):** subsequent display screen is shown.

## 8.7 “Holiday” function

When this function is selected, the thermostat is switched off during your absence *OFF*.

However, the frost protection function remains switched on.

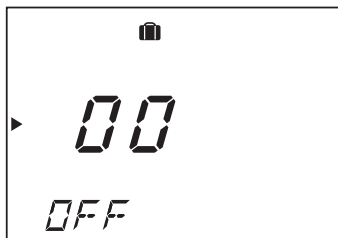

- Press the **(mode)** button five times in the general display screen: When setting the “Holiday” function, the *00* symbol flashes

for about 10 seconds.

- Use the **+** and **-** buttons to set the number of days (0 - 99) of your absence. The symbol  is displayed in the general display screen.

The function for the number of programmed days is then run.

When the number of programmed days is reached, the function  switches off automatically.

- For manual override of the “Holiday” function press the **(mode)** button once.

The  symbol does not show on the general display screen any longer.



## 8.8 Setting the time and date

### 8.8.1 Setting the current day of the week

- Press the **(mode)** button six times in the general display screen.
- Use the **(+)** and **(-)** buttons to set the current day of week.  
The elected day flashes.

<b>①</b> = Monday	<b>⑤</b> = Friday
<b>②</b> = Tuesday	<b>⑥</b> = Saturday
<b>③</b> = Wednesday	<b>⑦</b> = Sunday
<b>④</b> = Thursday	

The setting is saved:

- **automatically after 10 seconds:**  
general display screen is shown,
- **or after pressing the **(mode)** button:**  
subsequent display screen is shown.

### 8.8.2 Setting the time

- Press the **(mode)** button seven in the general display screen.
- Use the **(+)** and **(-)** buttons to set the hours.
- Press the **(mode)** button.
- Use the **(+)** and **(-)** buttons to set the minutes.





The setting is saved:

- **automatically after 10 seconds:**  
general display screen is shown,
- **or after pressing the  button:**  
subsequent display screen is shown.

Note: If the “Annual calendar” was activated by the installation company, the clock will automatically switch between summer and winter time.

### 8.8.3 Setting the date (\*)

(\*) the setting is possible only if the “Annual calendar” function is activated by your installation company.

- Press the  button 9 times in the general display screen.
- Use the  and  buttons to set the current date: day/month/year.

The setting is saved:

- **automatically after 10 seconds:**  
general display screen is shown,
- **or after pressing the  button:**  
subsequent display screen is shown.

### 8.9 Weekly heating program

The weekly heating program is active only in the automatic operating mode .

Note: To switch to daily programming, contact your installation company.



### 8.9.1 Example of a weekly heating program

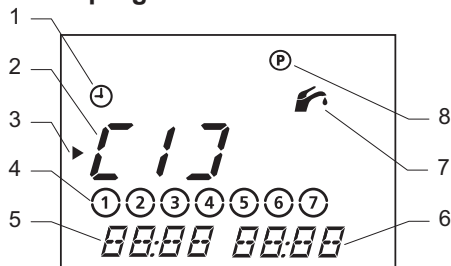

#### Legend

- 1 Selected operating mode
- 2 “Comfort” heating temperature field
- 3 Cursor (shows the value to be changed)
- 4 Day or group of days
- 5 Start time of heating program

- 6 End time of heating program
- 7 Programming the heating time zones
- 8 Programming menu

You can select up to 3 time zones for heating to ☀ “Comfort” temperature.

Examples of combinations:

- [ 1 ]: whole day
- [ 1 ]: morning and [ 2 ]: evening
- [ 1 ]: morning, [ 2 ]: lunch and [ 3 ]: evening

Important! These three time zones must not overlap.

Example of a weekly heating program:

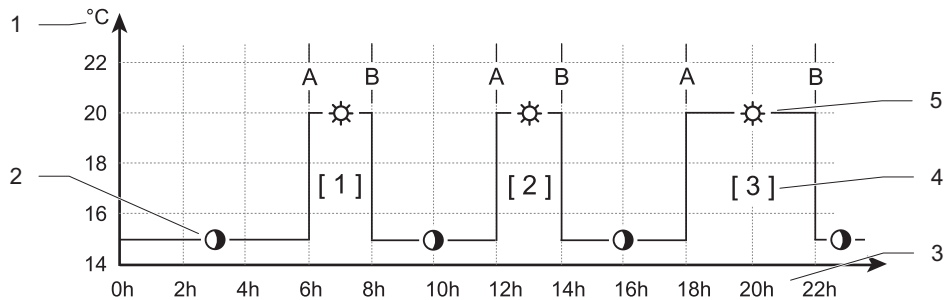

**Legend**

- A** Start time of heating program
- B** End time of heating program
- 1** Temperature axis, temperature is  
 "Eco" or ☀ "Comfort"

- 2** Heating to  "Eco" temperature
- 3** Time of day
- 4** Zone of heating to "Comfort" temperature
- 5** Heating to ☀ "Comfort" temperature

Factory settings for time zones:

Time axis	Day of week / group of days	Switch-on time	Switch-off time
[ 1 ]	① ② ③ ④ ⑤ 6 7	06:00	22:00
	1 2 3 4 5 ⑥ 7	07:30	23:30
	1 2 3 4 5 6 ⑦	07:30	22:00
[ 2 ]	-	-	-
[ 3 ]	-	-	-





### 8.9.2 Setting the weekly heating program

- Hold the **prog** button pressed for about 5 seconds.

The time zone will start flashing „[1]“.





- Select the time zone you wish to program – use the **+** and **-** buttons to set the day of week of group of days proposed according to the following table ( „[1]“, „[2]“ nebo „[3]“).
- Press the **prog** button and using the **+** and **-** buttons select the day of week or group of days proposed to select the following table:

Whole week	① ② ③ ④ ⑤ ⑥ ⑦
From Monday to Friday	① ② ③ ④ ⑤ 6 7
Weekend	1 2 3 4 5 ⑥ ⑦
For each day of the week	① , ② , ③ , etc.

- Press the  button and using the  and  buttons select the start and end times of the time zone.
- Press the  button again and set the following time zone.
- Repeat the previous programming steps.
- To exit the programming menu press the  button and hold it for about 10 seconds.

Displays the general display screen.

## 8.10 Hot water heating weekly program

- For system boilers with attached external hot water tank or combination boilers with flow-through water heating with hot water exchanger preheating option (COMFORT function).
- Hold the  button pressed until the display changes. Using the  button select the  symbol.
- Press the  button to continue.

### 8.10.1 Example of a 7 day heating programme - domestic hot water tank loading or preheat

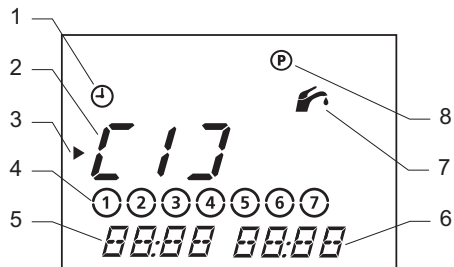

#### Legend

- 1 Selected operating mode
- 2 "Tank loading or preheat" time zone
- 3 Cursor (shows the value to be changed)

- 4 Day or group of days
- 5 Start time of heating program
- 6 End time of heating program
- 7 Programming the heating time zones
- 8 Programming menu

You can select up to 3 time zones for "Tank loading or preheat".

Examples of combinations:

- [ 1 ]: whole day
- [ 1 ]: morning and [ 2 ]: evening
- [ 1 ]: morning, [ 2 ]: lunch and [ 3 ]: evening

**Important!** These three time zones must not overlap.

At the flow-through water heating boilers, the preheating must be activated to make the control unit able to turn it off.

*Example of tank heating or the hot water exchanger preheating weekly program*

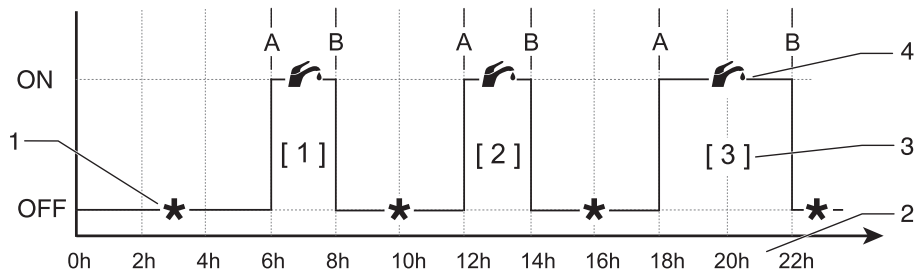

**Legend**

**A** Start time of program

**B** End time of program

**1** Domestic hot water heating OFF  
„Tank loading or preheat“

**2** Time of day

**3** „Tank loading or preheat“ time zone

**4** Operating domestic hot water heating ON



Factory settings for time zones:

Time axis	Day of week / group of days	Switch-on time	Switch-off time
[ 1 ]	① ② ③ ④ ⑤ 6 7	06:00	22:00
	1 2 3 4 5 ⑥ 7	07:30	23:30
	1 2 3 4 5 6 ⑦	07:30	22:00
[ 2 ]	-	-	-
[ 3 ]	-	-	-

### 8.10.2 Setting the 7 day hot water heating programme

- Hold the **prog** button pressed for about 5 seconds. Using the **+** button select

the **☒** symbol. The time zone will start flashing „[1]“.

- Select the time zone you wish to program – use the **+** and **-** buttons to set the day of week of group of days proposed according to the following table ( „[1]“, „[2]“ or „[3]“).
- Press the **prog** button and using the **+** and **-** buttons select the day of week or group of days proposed to select the following table:

Whole week	① ② ③ ④ ⑤ ⑥ ⑦
From Monday to Friday	① ② ③ ④ ⑤ 6 7
Weekend	1 2 3 4 5 ⑥ ⑦
For each day of the week	① , ② , ③ , etc.



- Press the **prog** button and using the **+** and **-** buttons select the start and end times of the time zone.
- Press the **prog** button again and set the following time zone.
- Repeat the previous programming steps.
- To exit the programming menu press the **prog** button and hold it for about 10 seconds.

Displays the general display screen.

## 8.11 Temporary override

Note:

- This setting is possible in the automatic heating mode **↓**.
- This modification permits temporary adjustment of the set room temperature until another change of temperature is made in the heating program (see following example).



Example of temporary adjustment of set room temperature:

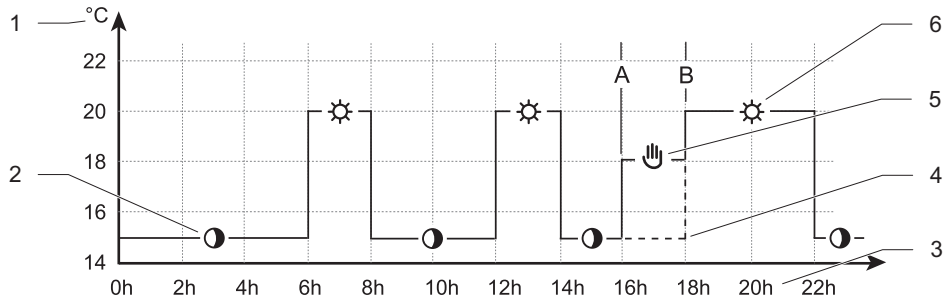

Instructions for Use

**Legend**

- A** Start time of temporary temperature adjustment
- B** End time of temporary temperature adjustment
- 1** Temperature axis, temperature is "Eco" or "Comfort"

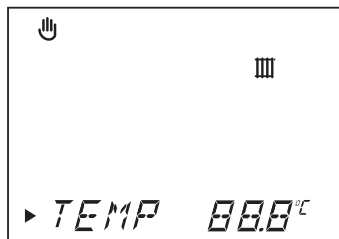

- 2** Heating to „Eco“ temperature
- 3** Hours of day
- 4** Start of heating to "Comfort" temperature
- 5** Temporary temperature adjustment
- 6** Heating to "Comfort" temperature

- In the general display screen use the  $\oplus$  and  $\ominus$  buttons to display the set room temperature. Symbol  is displayed and the previous temperature setting flashes.



- Using the  $\oplus$  and  $\ominus$  buttons to set the temporarily required room temperature

The set temperature flashes.

 	Temporary setting of room temperature (°C)
Minimum	8
Maximum	30

The setting is saved:

- **automatically after 10 seconds:** general display screen is shown,
- **or after pressing the mode button:** subsequent display screen is shown.

Upon another change of the temperature in the heating system the symbol  stops being displayed.

- Press the mode button for cancellation



of the temporary temperature adjustment.  
Symbol is displayed.

After 3 seconds the general display screen is displayed and symbol goes out.

## 8.12 Information menu

This menu lets you display various thermostat settings.

- In the general display screen press the button repeatedly until the following information is displayed:

Symbol is displayed.

- The display shows the “Comfort” heating temperature.

- The display shows the “Eco” heating temperature.
- The display shows the hot water setting value.
- The display shows the heating program time zones.
- The display shows time regions for HoW tank heating (exchanger preheating).
- The display shows the date (if the “annual calendar” is activated).
- The display shows the thermostat name.



### 8.13 Battery change

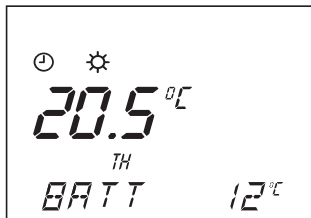

When the “BATT” symbol lights up on the display, the battery life will end within 1 month.

**Note:**

If the batteries are not replaced in time, the controller will switch to “Comfort” temperature.

Programmed settings will not be deleted.

- Before inserting new batteries, clean the battery compartment.
- Do not mix new and old batteries, do not combine different battery types.
- Do not use rechargeable batteries.
- Never expose batteries to excessive heat or an open flame, never disassemble batteries to check for short circuiting.
- Do not leave old batteries in the regulator.
- If the electrolyte is leaking and comes into contact with skin or clothing, wash it immediately with water.

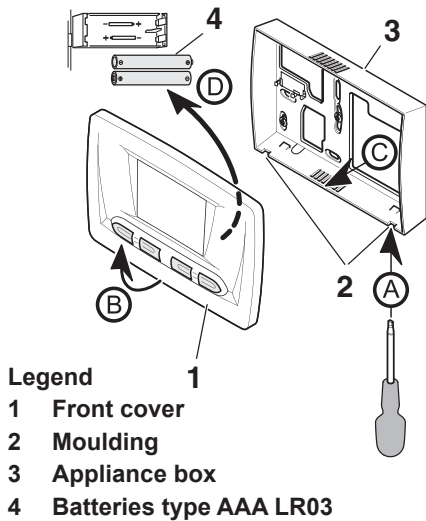

- Remove the front cover (1) from the appliance box (3) respecting the order of operations (A) to (C).
- Replace the old batteries (D) with new AAA LR03 batteries, respecting the polarity (“+” and “-”).

*Instructions for Use*

## 9 Troubleshooting

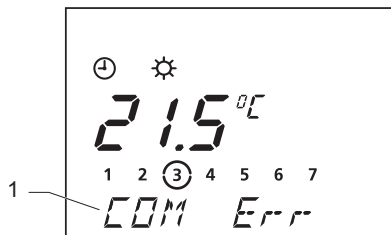

### Legend

**1 Multifunctional display area**

In the event of a fault, the thermostat displays error messages in the multifunctional display area (1).

### Warning!

Never try to service or repair the appliance by yourself. Let an installation and service company to remedy the fault.



<b>Fault</b>	<b>Cause</b>	<b>Corrective action</b>
The display is off.	Electric supply failure.	<p>Check that:</p> <ul style="list-style-type: none"> <li>- the batteries were installed correctly in the battery holder,</li> <li>- battery polarity is correct,</li> <li>- batteries have not already been used before. In such case, replace them with new ones.</li> </ul> <p>The appliance starts automatically once the power supply is on. If the fault persists, please contact a skilled professional.</p>
Room temperature does not reach the temperature programmed.	Poor adjustment of thermostatic valves on the radiators.	Check that the thermostatic valves of the radiators in the room where the appliance is installed are set to maximum. If this is correct, please contact a skilled professional.
<i>BATT</i>	Low battery capacity	Replace batteries (see chapter "Battery change") or contact a skilled professional.

<b>Fault</b>	<b>Cause</b>	<b>Corrective action</b>
<i>COM Err</i>	Communication error between the boiler and the appliance.	Please contact a skilled professional.
<i>RF Err</i>	Communication error between the radio receiver and the room thermostat.	Check that there is no power “interruption” and the boiler is connected correctly and switched on. As soon as the power supply has been re-established, the appliance automatically turns back on. If the fault persists, please contact a skilled professional.
<i>BMU Err</i>	Boiler fault	Please contact a skilled professional.

*Please note: some weather meters with wireless transmission at 433 MHz frequency may interfere with the control unit operation. In that case relocate the weather meter.*



## 10 Frost protection

The frost protection system activates the boiler when:

- The ambient temperature in the room where the appliance is installed falls below 3 °C.
- The “Holiday” function  is activated in your absence (see chapter “Holiday” function) for a certain period.
- Set the thermostat to the absence status *OFF* .
- If you leave home for a long period, consult the boiler manual.





## Installation and servicing Index

<b>1</b>	<b>Comments on the instructions</b>	<b>36</b>	<b>5.7</b>	Fixing the receiver back box to the wall.....	<b>46</b>
<b>2</b>	<b>Appliance Description</b> .....	<b>36</b>	<b>5.8</b>	Electrical connection .....	<b>47</b>
2.1	CE marking .....	36	<b>6</b>	<b>Commissioning</b> .....	<b>48</b>
2.2	Block diagram .....	37	<b>7</b>	<b>Adjustments</b> .....	<b>49</b>
<b>3</b>	<b>Location</b> .....	<b>37</b>	7.1	Recommended settings during installation .....	49
<b>4</b>	<b>Safety instructions and regulations</b> .....	<b>40</b>	7.2	Recommended after-sale settings .....	52
<b>5</b>	<b>Appliance installation</b> .....	<b>41</b>	<b>8</b>	<b>Fault diagnostics</b> .....	<b>54</b>
5.1	Dimensions .....	41	<b>9</b>	<b>Check / Commissioning</b> .....	<b>57</b>
5.2	Appliance package contents ..	42	<b>10</b>	<b>User information</b> .....	<b>57</b>
5.3	Opening the appliance .....	42	<b>11</b>	<b>Technical data</b> .....	<b>58</b>
5.4	Fixing appliance to a wall .....	43	<b>12</b>	<b>Outside sensor</b> .....	<b>60</b>
5.5	Installing the batteries.....	44			
5.6	Installing the receiver .....	45			

## 1 Comments on the instructions

- Please give all of the instructions to the user. The user shall keep them for future reference.

The manufacture accepts no liability in case of damage due to the non-compliance of the instruction manual.

## 2 Appliance Description

### 2.1 CE marking

The CE mark on this appliance shows compliance with:

- Directive 89/336/EEC on the approximation of the Laws of Member States relating to electromagnetic compatibility.
- Directive 73/23/EEC on the harmonisation of the Laws of Member States relating to electrical equipment designed for use within safe voltage limits.

## 2.2 Block diagram

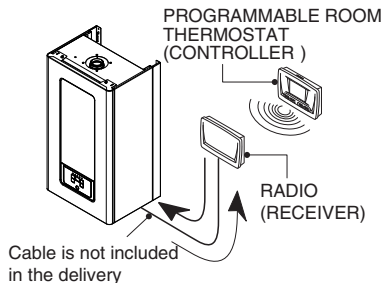

## 3 Location

### 3.1 Room thermostat position

- Do not install the appliance above another appliance that could damage it (for example, above a cooker that might emit steam or grease) or in a room, which has a lot of aggressive dust in the atmosphere.
- The appliance must be installed in a room protected from freezing temperatures. Take the necessary precautions.
- Install the control in such a manner so as to guarantee optimum measurement of the ambient temperature by positioning it:



- On inside wall in the main room of the house.
- Approximately at 1.5 metres from the ground.
- Do not install the appliance:
  - Near heat sources such as radiators, televisions, sunlight, etc.
  - On cold walls.
  - Between furniture, behind curtains, or other objects that could effect measurement of ambient air temperature in the room.
  - Close to draughts of air that could come from doors or windows.



- Explain these requirements to the home owner.

### **3.2 Receiver position**

- Install the receiver module nearby the boiler, 1.8 m above the ground to avoid radio transmission interruption.
- Position the radio receiver module as far as possible from metal parts (cables, fuse box, metal surfaces...)





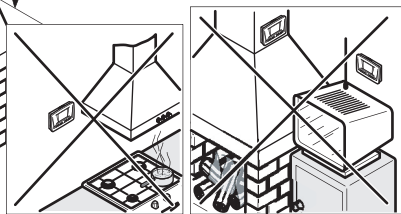
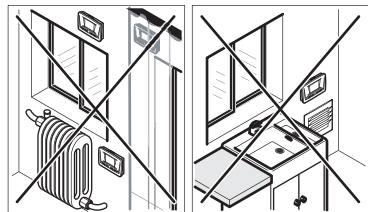
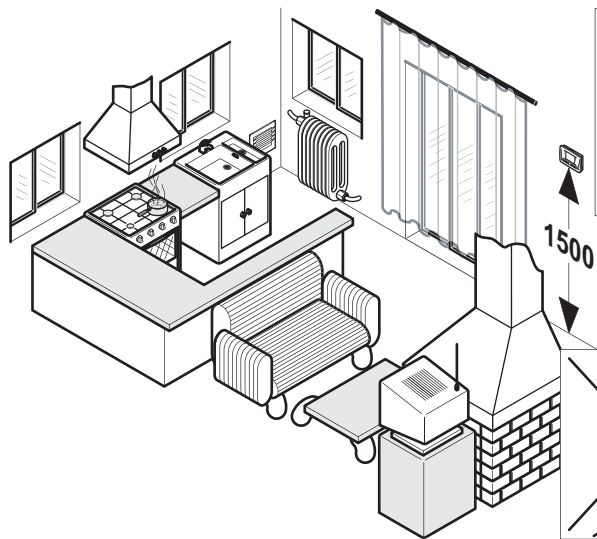

*Installation and servicing*



## 4 Safety instructions and regulations

This appliance is tested and certified for safety and performance. It is, therefore, important that no alteration is made to the appliance, without written permission from the manufacturer.

Any alteration not approved by the manufacturer may result in invalidation of the certification, appliance warranty and may also breach valid laws.

### 4.1 Safety instructions

Warning! Incorrect installation can cause electric shock or appliance damage.

- Protect all the electrical components from water when you carry out any work.

### 4.2 Safety regulations

When installing and commissioning the appliance, the regulations below shall be observed in their current version.

The installation of this appliance must be carried out by a competent person in accordance the rules in force in the countries of destination. Manufacturer's instructions must not be taken as overriding statutory requirements.



## 5 Appliance installation

### 5.1 Dimensions

All the dimensions in this chapter are expressed in mm.

Dimension A is the only one in which the control unit and the receiver module differ.

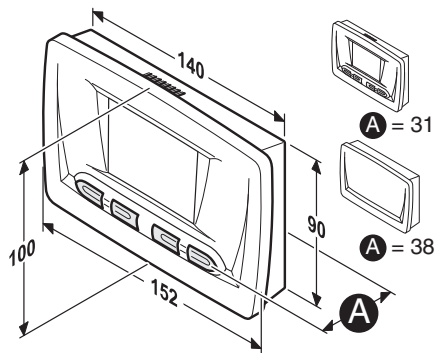

*Installation and servicing*

## 5.2 Appliance package contents

The Thermolink RC thermostat is delivered with the receiver module and with:- 1 Instructions for Use,

- 2 pcs. battery type „AAA LR03“
- 1 plastic bag containing 4 screws and 4 wall plugs.

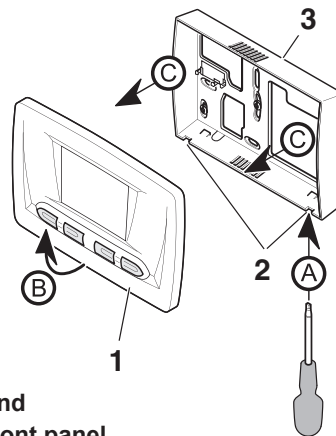

## 5.3 Opening the appliance

- Remove the front cover (1) from the appliance box (3) respecting the order of operations (A) to (C).

### Legend

- 1 Font panel
- 2 Mouldings
- 3 Appliance box



## 5.4 Fixing to a wall

- Make sure you use suitable tools for installation works.
- Chose the location of the appliance. See chapter “Appliance location”.
- Position the appliance box on a wall.
- Drill the holes for the attachment screws in line with the 2 pre-moulded attachment holes in the appliance box.
- Insert the wall plugs (4) in the drilled holes.
- Proceed with connecting the appliance as per chapter „Electrical connection“.
- Secure the appliance box to the wall using the attachment screws as illustrated on the previous page.
- Replace the front cover on the appliance box.



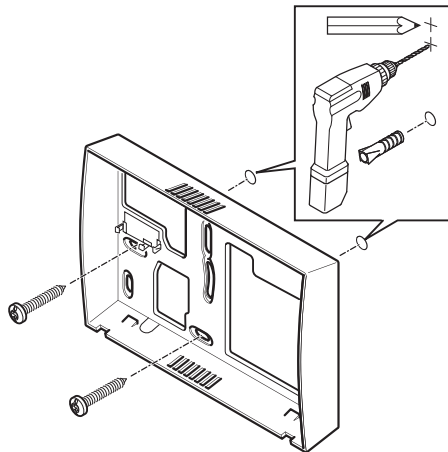

## 5.5 Installing the batteries

Carefully install the batteries supplied respecting the polarity (direction of “+” and “-”).

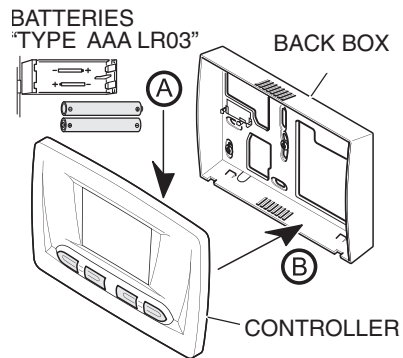

## 5.6 Otevření a instalace přijímacího modulu

- Use a twin core cable with minimum  $2 \times 1.5$  sq.mm cross section to connect the receiver module to the boiler.
- Choose a place for the receiver module according to the section 3.2.
- Remove the front cover and follow the steps from (A) to (C) as shown on the following picture.

### Legend

- 1 Receiver
- 2 Mouldings
- 3 Receiver back plate

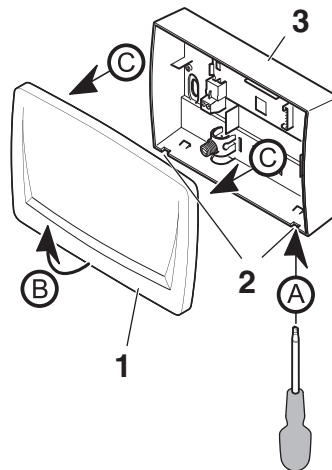

## 5.7 Fixing the receiver back box to the wall

- Fit the back box to the wall, refer to diagram.

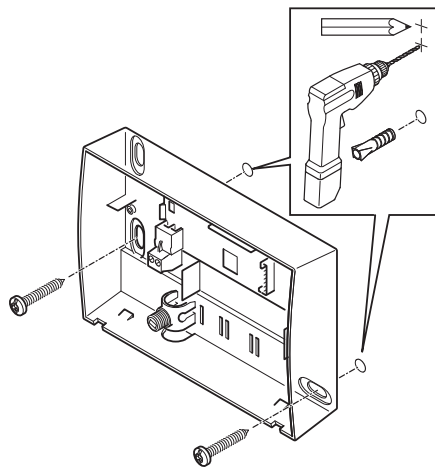



## 5.8 Electrical Connection (of the receiver module to the boiler)

**WARNING:** Disconnect the boiler from the power supply. Electrical connection of the receiver module to the boiler can only be made by a certified person.

Make the receiver module-to-boiler connection using a twin core cable of a correct cross-section. Connect the cable to the terminal in the receiver module according to the picture. Polarity does not matter.

Connect the cable to the “eBus” marked terminal at the boiler. Terminal is accessible after removing the boiler’s front cover and tilting the boiler control panel on its right side.

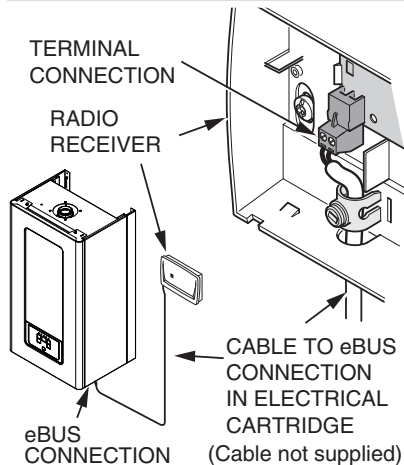

## 6 Commissioning

### IMPORTANT:

- The Thermolink RC control unit is factory set to the modulation mode. In that case the boiler works as if its output is modulated.
- If requested, the modulation mode must be selected before the control unit starts modulating the boiler's performance and the set room temperature in the building has been reached.
- Do not remove the link wire from the „Room thermostat“ connection terminal of the main board of the boiler.

**Caution:** In case the room control unit is connected, the maximum temperature of the HoW and heating water (HeW) must

be selected on the boiler control panel. Under these conditions the temperature set at the boiler serves as a limit value.

**Example:** HeW temperature is calculated at 65°C by the equithermal regulation. At the boiler control panel however, a lower temperature is set, e.g. 55°C. In that case, the boiler heats the HeW only up to the 55°C.

Maximum HeW temperature must be set with regard to a given heating system (e.g. floor heating).

### 6.1 Boiler startup

- Put the boiler into operation.
- Fully open the thermostatic valves in the room where the room thermostat is located.



## 7 Adjustments

Modification of certain thermostat parameters can increase reliability and prevent malfunction in the future.

### 7.1 Recommended settings during installation

To ensure that the thermostat works at peak performance, several values must be preset.

- Press the **(mode)** button for 10 seconds to enter the settings menu.
- When  and "CODE 00" is displayed use the **+** and **-** buttons to set "CODE 96" on the display.

- Confirm by pressing **(mode)**.
- When first menu "COMF" starts flashing, use the **+** and **-** buttons to set the required "Comfort" temperature value.
- Press **(mode)** for saving and presetting another parameter (see following Table).
- To save all preset values press and hold **(mode)** for 10 seconds.

The display will return to the general display screen after being idle 1 minute or after pressing and holding **(mode)** for 10 seconds.



<b>Menu</b>	<b>Title</b>	<b>Action / Information</b>
<i>COMF</i>	Presetting the "Comfort" heating temperature	Select a value between 5 °C and 30 °C. (factory setting: 20 °C)
<i>ECO</i>	Presetting the "Eco" heating temperature	Select a value between 5 °C and 30 °C. (factory setting: 15 °C)
<i>SAN</i>	Setting hot water temperature	Select a value between 38 °C and 65 °C. (factory setting: 60 °C)
<i>MOD</i>	Selecting thermostat mode	Select value: 0 = without modulation ► mode ON/OFF 1 = with modulation ► automatic calculation of heating setting (factory setting)  <b>Caution:</b> When an outdoor temperature sensor is connected to the boiler, modulation mode is automatically selected. Selection of other mode is disabled, two dashes are displayed instead of a parameter.

Menu	Title	Action / Information
<i>P7.P1</i>	Select 24h or 7 day programming	Select between P1 and P7: P1 = daily programming P7 = weekly programming (factory setting)
<i>COMP</i>	Selecting heating curve (*)	Select a value between 0.2 and 4. (factory setting: 1.2) To make this setting see the manual for the outside sensor connected to the boiler.
<i>DATE</i>	Annual calendar activation	Select a value: 0 = off (factory setting) 1 = on
<i>(*) Displayed only if outside sensor is connected to the boiler.</i>		

Note: To reset the factory settings hold the **(mode)** button pressed for 20 s.

The display will then flash 3x and all values will return to the original factory settings.

## 7.2 Recommended after-sale settings

- Press the **(mode)** button for 10 seconds to enter the settings menu.
- When and  a „CODE 00“, s displayed use the **(+)** and **(-)** buttons to set „CODE 35“.
- Confirm by pressing **(mode)** . The first menu „CH On“ will be displayed.
- Press **(mode)** for saving and presetting another parameter (see following Table).
- Use the **(+)** and **(-)** buttons to set the required value.
- To save all preset values press and hold

**(mode)** for 10 seconds.

The display will return to the general display screen after being idle 1 minute or after pressing and holding **(mode)** for 10 seconds.

<b>Menu</b>	<b>Title</b>	<b>Action / Information</b>
<i>CH On</i>	Extra heating	Request for heating to 50 °C is simulated. Boiler burner and pump are switched on.
<i>RF x</i>	<i>Wireless communication check</i>	The receiver will send the controller signal every 5 seconds. For each signal received, the counter "x", initially set "0", is incremented. The red LED on the main circuit board of the radio receiver blinks.
-	-	All display segments are displayed.
<i>VERS</i>	Program version	The current program version is displayed.
<i>CTIN</i>	Correction of thermostat ambient temperature	Enables adjustment of the displayed temperature by $\pm 3$ °C. (factory setting: 0)
<i>CTEX</i>	Correction of outside temperature	Enables adjustment of the displayed temperature by $\pm 5$ °C. (factory setting: 0)
<i>(*) Displayed only if outside sensor is connected to the boiler.</i>		

## 8 Fault diagnostics

A list of boiler specific fault codes are available in the boiler manual to aid fault finding.

Faults that cannot be rectified with the guidance from this section and the boiler manual, will require the intervention of your installer/service engineer.

In the event of a problem:

- Check the error messages in the thermostat malfunction display.
- Check the status of the 2 LEDs (green and red) see diagram.

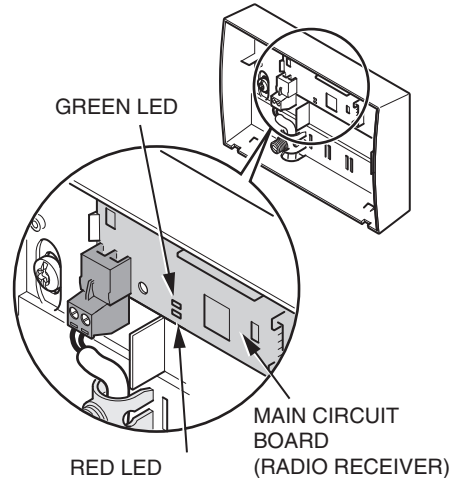



Fault		Cause	Solution
Radio receiver	Room thermostat		
Green LED off	<i>RF Err</i>	<ul style="list-style-type: none"> <li>- No electrical supply</li> <li>- eBUS connecting cable defective</li> </ul>	<ul style="list-style-type: none"> <li>• Check that there is no power cut and that the boiler is connected correctly and switched on.</li> <li>• Check the electrical connection between the receiver and the boiler.</li> </ul>
Red LED off			

Installation and servicing

Fault		Cause	Solution
Radio receiver	Room thermostat		
Red LED lit	<p><i>BATT</i></p> <p><i>COM Err</i></p> <p><i>BMU Err</i></p> <p><i>Display not lit.</i></p>	<p>- Radio signal transmission error.</p> <p>- EBUS communications error.</p> <p>- Radio receiver defective.</p> <p>- EBUS connecting cable defective.</p>	<ul style="list-style-type: none"> <li>• Check that: <ul style="list-style-type: none"> <li>- The controller batteries are properly installed in their compartment.</li> <li>- The battery polarity is not reversed.</li> <li>- The batteries are not exhausted.</li> </ul> </li> </ul> <p>If so replace with new batteries.</p> <ul style="list-style-type: none"> <li>- Check the radio communication between the controller and receiver by using the “RF x” menu item on the controller, (refer to “After sales settings”-section).</li> </ul>

## **9 Check / Commissioning**

Once the appliance is installed, check whether it runs:

- Check that the thermostat is installed in compliance with the Instructions for Use and it works.
- Check that the thermostat and connected equipment for safety, settings and operating state.
- Increasing the temperature on display of control unit above the current room temperature will switch the boiler on.
- Decreasing the temperature on display of control unit below the current room temperature will switch the boiler off.

## **10 User information**

The user should know how to use the appliance.

- Explain the user the appliance operating principles and demonstrate if required.
- Have a look at the operating instructions together and answer any questions if need be.
- Give the user all of the manuals and documents concerning the appliance and tell the user to keep them near the appliance.
- Explain more precisely the safety principles they should observe.

## 11 Technical data

Description	Unit	Thermolink RC
Transmission / reception frequency	MHz	868
Average unobstructed working range(*)	m	150
(*) Can vary according to installation conditions and electromagnetic environment.		

Description	Unit	Controller
Max room temperature in the room where the control is installed	°C	50
Height	mm	100
Width	mm	152
Depth	mm	31
Power supply 2 batteries type „AAA LR03“	V	2 x 1,5
Battery lifespan	month	18
Electrical protection		IP 20
Electrical category		II

<b>Description</b>	<b>Unit</b>	<b>Receiver</b>
Height	mm	100
Width	mm	152
Depth	mm	38
eBus power supply voltage	V	24
Minimum diameter of electrical connection cables	mm <sup>2</sup>	2 x 1,5
Maximum length of electrical connection cables	m	300
Electrical protection		IP 20
Electrical category		II

*Installation and servicing*



## 12 Outside sensor\* - optional accessories

(\*)Not delivered with thermostat

### 12.1 Sensor location

- The outside sensor should be located on the north/northwest wall of the building.
- For optimal indication of outside temperature for 3-storey or lower buildings, the sensor should be located on the wall at about 2/3 of the building height. For higher buildings a position between the 2nd and 3rd floor is recommended.
- When installed, the outside sensor should not be protected against wind, but should also not be exposed to draught.

Also, it should not be exposed to sunshine.

- The outside sensor should be located at least 1 m from openings in the outside walls and away from constant or random sources of hot air.



## 12.2 Equithermal curves

Graph with heating curves for required room temperature 20 °C.

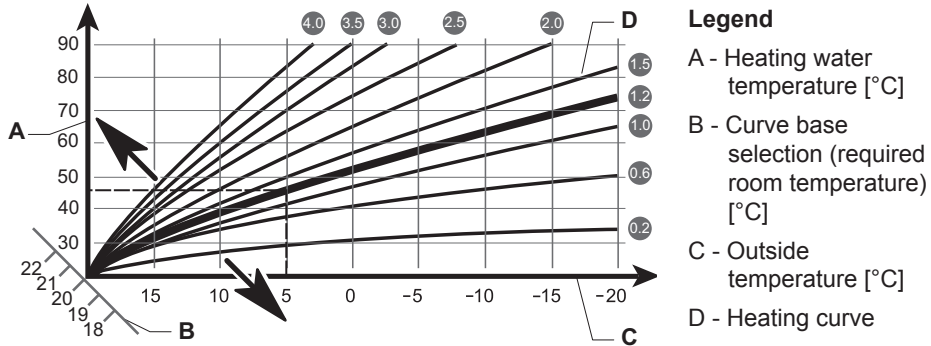

### 12.3 Setting the control unit with outdoor sensor connected – example

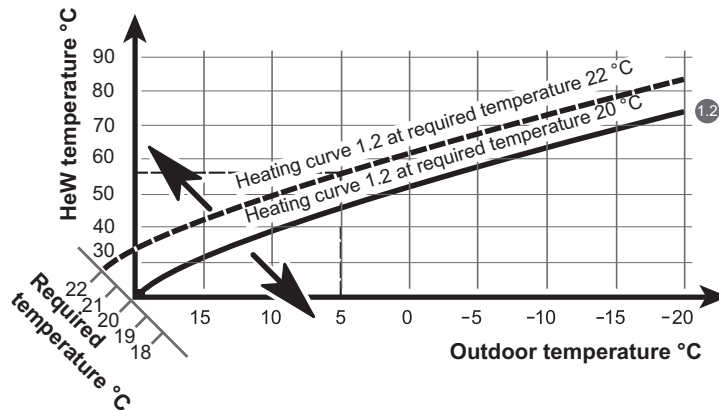



**Example:** If a heating curve 1.2 is selected and a different temperature than 20 °C is required for the heated room, e.g. 22 °C, the heating curve is shifted as shown (see picture). The selected heating curve 1.2 is shifted in parallel at a 45° angle on the “B” axis. Hence for required room temperature of 22 °C and outdoor temperature of 5 °C, HeW temperature is automatically calculated at about 56 °C.

**Caution:** If the required temperature is not reached in the room, or the temperature rises too slowly, please select a heating curve of a higher number.

## 12.4 Outdoor sensor value table

Temperature (°C)	Negative thermal coefficient
-25	2167 Ω
-20	2076 Ω
-15	1976 Ω
-10	1862 Ω
-5	1745 Ω
0	1619 Ω
5	1494 Ω
10	1387 Ω
15	1246 Ω
20	1128 Ω
25	1020 Ω
30	920 Ω
35	831 Ω
40	740 Ω

## 12.5 Outside sensor curve

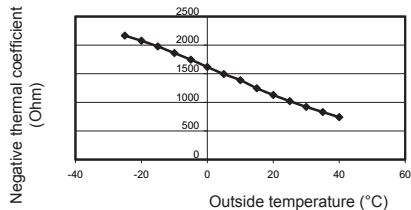

## 12.6 Outdoor sensor deviation

The negative thermal coefficient value must be in the following intervals:

-20 °C < outside temperature < 25 °C →  
+/-0,8K

-40 °C < outside temperature < -20 °C or  
25 °C < outside temperature < 40 °C →  
+/-2K

## 12.7 Outside sensor parts

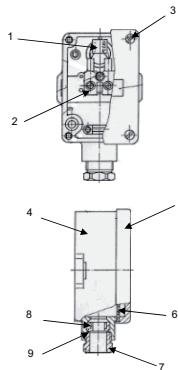

	Description	Qty
1	Sensor	1
2	Bipolar connection terminal	1
3	Stainless screws	4
4	Plastic box	1
5	Plastic cover	1
6	Seal	1
7	Cable gland	1
8	Rubber O-ring	1
9	Metal washer	1

## 12.8 Connection and technical parameters of sensor

Outdoor sensor is connected to the boiler control board right to the dedicated terminal box (Outdoor NTC) with a twin core cable with minimum  $2 \times 1.5$  sq.mm cross section.

Nominal voltage	5 V
Power consumption	< 10 mW
Electrical category	II
Electrical protection	IP 44



[www.protherm.eu](http://www.protherm.eu)

Protherm spol.s r.o.  
Pplk. Pljušťa  
909 01 Skalica  
Tel.: +421 34 6966 101  
Fax: +421 34 6966 111

Your service:

