

protherm



Thermolink P

Instructions for Use Installation and Servicing

- **Version eBUS**
- **Setting heating temperature „Comfort“ and „Eco“, DHW**
- **Possibility equithermal regulation**
- **Selecting with or without modulating**
- **Daily or weekly programming**
- **Holiday“ function, temporary override, frost protection**

EN
version **CE**

0020040126 - v.1.1 1/2008

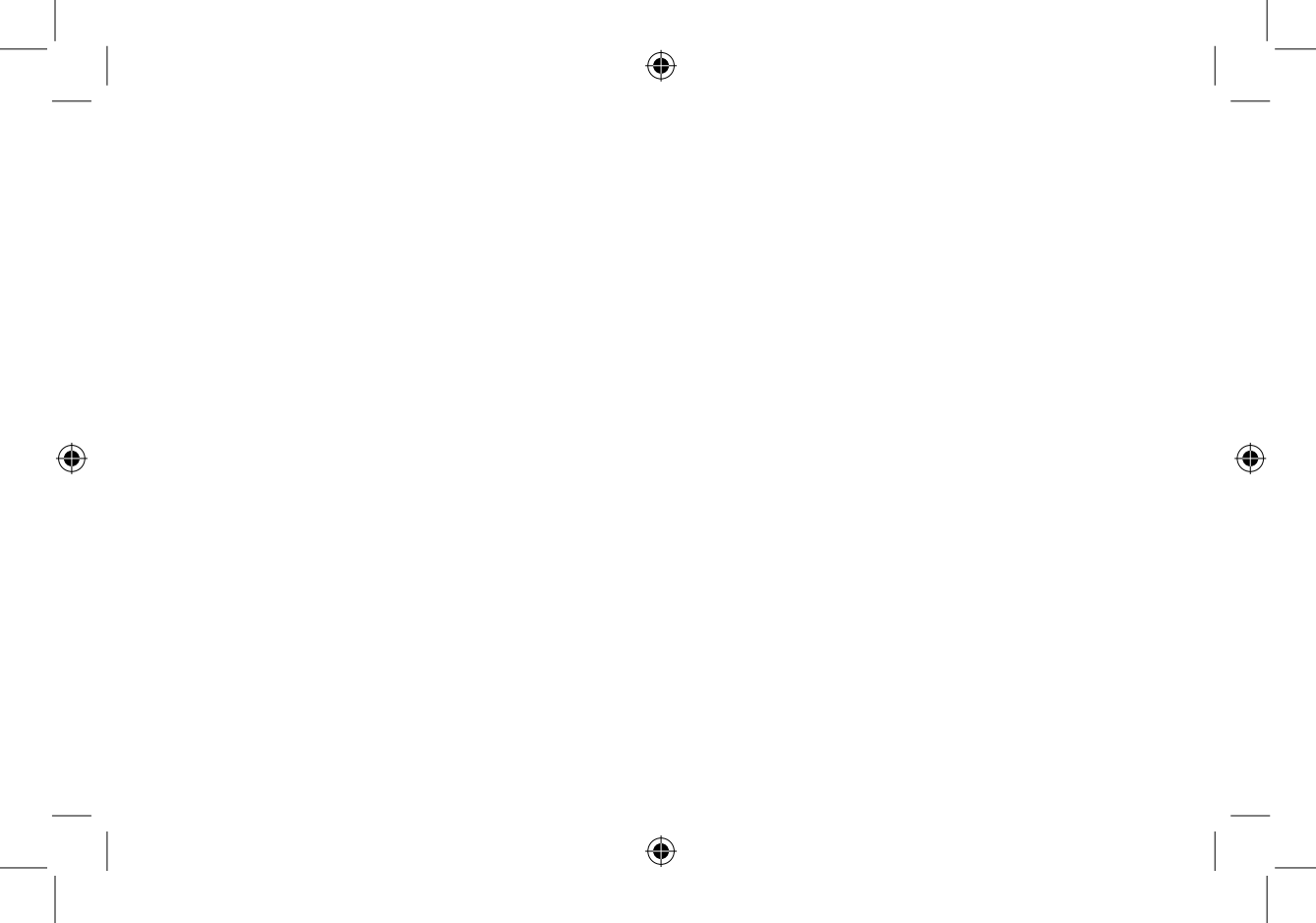

Instructions for Use

Index

1	General	2	7.6	Setting heating temperature	11
			7.6.1	“Comfort” heating temperature...	11
2	Documentation.....	2	7.6.2	“Eco” heating temperature	12
			7.6.3	Setting hot water temperature ...	13
3	Warranties / Responsibility	3	7.7	“Holiday” function	14
4	Thermostat use	4	7.8	Setting the time and date.....	15
			7.9	Week heating program	16
5	Thermostat maintenance.....	5	7.10	Hot water heating weekly program	20
			7.11	Temporary override.....	24
6	Recycling	5	7.12	Information menu	27
			8	Troubleshooting	28
7	Thermostat use	6	9	Frost protection.....	30
7.1	Front cover	6			
7.2	Description of Display	7			
7.3	Description of buttons	7			
7.4	General display screens	9			
7.5	Operating mode selection	9			



1 General

Thermolink P is a weekly programmable room thermostat which enables setting heating comfort according to your needs at selected time intervals. This unit also allows also setting the hot water heating time.

This thermostat includes an integrated device for temperature modulation based on required room temperature.

The installation and commissioning of the appliance has to be carried out by a qualified electrician according to connection diagrams and in compliance with respective safety regulations.

To achieve class II protection, appropriate installation measures must be taken accor-

ding to directive VDE 0100. This independently installed appliance is used to control temperature exclusively in dry rooms with a standard atmosphere.

Use the services of an authorized installation and service company for maintenance and service purposes.

2 Documentation

- Please keep this manual safe for future reference.

The manufacture shall not be liable for unprofessional use of the appliance contrary to this manual, and in case of a defect for such reasons the manufacture shall not be liable for any damages.





3 Warranty / Responsibility

Your appliance is guaranteed for a period of 24 months from the date of sale. The manufacture shall accept only defects in materials and workmanship.

- The appliance was installed by a qualified professional in accordance with installation instructions, and all the relevant codes of practice, standards and legislation in force.
- The appliance has been used for in accordance with the Instructions for Use.
- The control has not been serviced, maintained, repaired dismantled or



tampered with during the guarantee period, by anyone other than a competent person.

The warranty does not cover:

- any defects or damage resulting from incorrect or poor installation.
- Any defects in the system to which the appliance is connected.
- Any deterioration or maladjustment following changes in the characteristics of the electrical supply voltage.

Notification of any fault should be made to the control installer. No repairs should be undertaken upon the control, intending





it to be covered by the product guarantee without prior authorisation from the manufacturer.

4 Thermostat use

This appliance is a programmable room thermostat designed for controlling heating equipment. Depending on room temperature and the set heating program, it cuts heating costs.

Any other use is regarded as inappropriate and prohibited.



This appliance is a programmable room thermostat designed for controlling heating equipment. Depending on room temperature and the set heating program, it cuts heating costs.

Any other use is regarded as inappropriate and prohibited.



5 Thermostat maintenance

- Clean the surface of the appliance with damp soapy cloth.
- Make sure that no water gets inside the appliance.
- Do not use any abrasive cleaning product as it could damage the housing or plastic case.



but recycle them. The appliance should be recycled as electronic waste.

6 Recycling

The appliance comprises many recyclable parts, like the packaging, manuals and appliance itself. At the end of the appliance's service life, do not dispose of the packaging and manuals in domestic waste



7 Thermostat use

7.1 Front cover



6



Legend

- 1 Display
- 2  Mode button
- 3  Programme button
- 4  Minus button
- 5  Plus button

7.2 Description of display

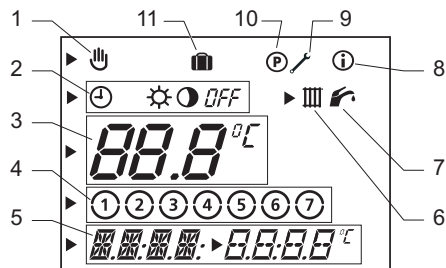

Legend

- 1 Temporary override
- 2 Indication of operating mode
- 3 Multifunctional display zone (1)
- 4 Days of week
- 5 Multifunctional display zone (2)
- 6 Heating water heating symbol
- 7 Hot water heating symbol
- 8 Information menu symbol
- 9 Service menu symbol
- 10 Programming menu symbol
- 11 "Holiday" function symbol

7.3 Description of button

7.3.1 Button

Repeated pressing of the button  opens the following setting:



Presses	Description
1	Selection of operating mode
2	Selection of "Comfort" heating mode
3	Selection of "Eco" heating mode
4	Setting of hot water temperature
5	"Holiday" function
6	Setting the day of the week
7	Time setting – hours
8	Time setting – minutes
9	Setting the date

7.3.2 Button

Pressing the button :

- **Repeatedly:** you can view different programs.
- **Pressing and holding the button for 5 seconds:** you can modify the heating program.

7.3.3 Button

Press the button  to decrease the set value.

7.3.4 Button

Press the button  to increase the set value.

7.4 General display screens

At first switch-on the display shows the general screen.

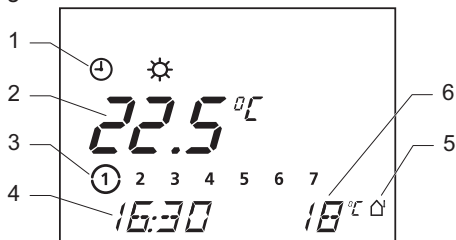





Legend

- 1 Current operating mode
- 2 Room temperature
- 3 Current day of the week
- 4 Current time
- 5 Outside sensor presence (*)
- 6 Outside temperature (*)

(*) Displayed only if an outside sensor is connected to the boiler.

7.5 Operating mode selection

- To select the operating mode press the **mode** button in the general display screen. Symbol starts flashing (1).
- Use the **+** and **-** buttons to select the operating mode. The selected mode's symbol starts flashing.

Symbol	Operating mode
	Automatic: Depending on the set time, the thermostat switches between temperatures  and  in the heating mode.
	Comfort: Heating to a comfortable temperature.
	Eco: Heating to an economical temperature.
<i>OFF</i>	Shutdown: Heating is switched off. Frost protection function is still functional.

The setting is saved:

- **automatically after 10 seconds:** general display screen is shown,
- **or after pressing the mode button:** subsequent display screen is shown.

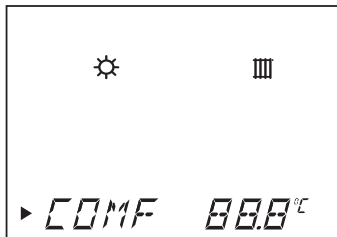

7.6 Setting heating temperature

7.6.1 Setting “Comfort” heating temperature



- Press the **(mode)** button twice in the general display screen.
- Use the **(+)** and **(-)** buttons to set the  “Comfort” temperature.

The temperature value to be set flashes.

 	Temperature (°C)
Minimum	5
Recommended	20
Maximum	30

Instructions for Use

The setting is saved:

- **automatically after 10 seconds:** general display screen is shown,
- **or after pressing the **(mode)** button:** subsequent display screen is shown.

7.6.2 Setting “Eco” heating temperature

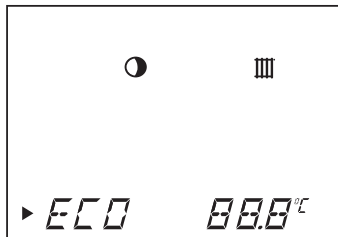

- Press the **(mode)** button three times in the general display screen.
- Use the **+** and **-** buttons to set the **●** “Eco” temperature. The temperature value to be set flashes.

● ■■	Temperature (°C)
Minimum	5
Recommended	15
Maximum	30

The setting is saved:

- **automatically after 10 seconds:** general display screen is shown,
- **or after pressing the **(mode)** button:** subsequent display screen is shown.

7.6.3 Setting hot water temperature



- Press the **(mode)** button four times in the general display screen.
- Use the **+** and **-** buttons to set the hot water temperature **888**.

The temperature value to be set flashes.

- **Caution:** this parameter does not affect the function of boiler used only for heating. Hot water temperature **SAN** at the hot water tank is controlled by means of an NTC sensor.

	Temperature (°C)
Minimum	38
Recommended	60
Maximum	65

The setting is saved:

- **automatically after 10 seconds:** general display screen is shown,
- **or after pressing the button **(mode)**:** subsequent display screen is shown.

7.7 “Holiday” function

When this function is selected, the thermostat is switched off during your absence *OFF*.

However, the frost protection function remains switched on.

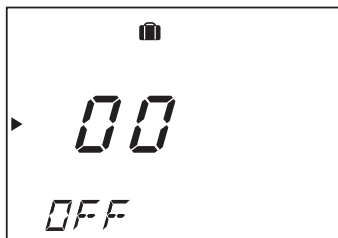

- Press the **(mode)** button five times in the general display screen: When setting the “Holiday” function, the *00* symbol flashes

for about 10 seconds.

- Use the **+** and **-** buttons to set the number of days (0 - 99) of your absence. The symbol  is displayed in the general display screen.

The function for the number of programmed days is then run.

When the number of programmed days is reached, the function  switches off automatically.

- For manual override of the “Holiday” function press the **(mode)** button once.

The  symbol does not show on the general display screen any longer.

7.8 Setting the time and date

7.8.1 Setting the current day of the week

- Press the **(mode)** button six times in the general display screen.
- Use the **(+)** and **(-)** buttons to set the current day of week.
The elected day flashes.

① = Monday	⑤ = Friday
② = Tuesday	⑥ = Saturday
③ = Wednesday	⑦ = Sunday
④ = Thursday	

The setting is saved:

- **automatically after 10 seconds:**
general display screen is shown,
- **or after pressing the **(mode)** button:**
subsequent display screen is shown.

7.8.2 Setting the time

- Press the **(mode)** button seven in the general display screen.
- Use the **(+)** and **(-)** buttons to set the hours.
- Press the **(mode)** button.
- Use the **(+)** and **(-)** buttons to set the minutes.

The setting is saved:



- **automatically after 10 seconds:** general display screen is shown,
- **or after pressing the mode button:** subsequent display screen is shown.

Note: If the “Annual calendar” was activated by the installation company, the clock will automatically switch between summer and winter time.

Caution: Check the time and date settings in the case of a power failure lasting more than 30 minutes.

7.8.3 Setting the date (*)

(*) the setting is possible only if the “Annual calendar” function is activated by your installation company.

- Press the mode button eight times in the general display screen.
- Use the + and - buttons to set the current date: day/month/year.

The setting is saved:

- **automatically after 10 seconds:** general display screen is shown,
- **or after pressing the mode button:** subsequent display screen is shown.

7.9 Weekly heating program

The weekly heating program is active only in the automatic operating mode ↓.

Note: To switch to daily programming, contact your installation company.



7.9.1 Example of a weekly heating program

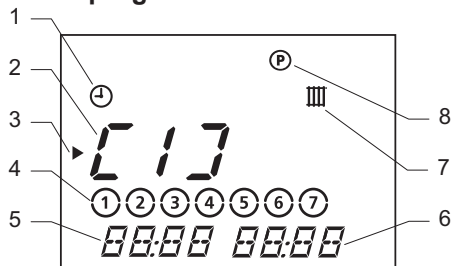

Legend

- 1 Selected operating mode
- 2 “Comfort” heating temperature field
- 3 Cursor (shows the value to be changed)
- 4 Day or group of days
- 5 Start time of heating program

- 6 End time of heating program
- 7 Programming the heating time zones
- 8 Programming menu

You can select up to 3 time zones for heating to ☀ “Comfort” temperature.

Examples of combinations:

- [1]: whole day
- [1]: morning and [2]: evening
- [1]: morning, [2]: lunch and [3]: evening

Important! These three time zones must not overlap.

Example of a weekly heating program:

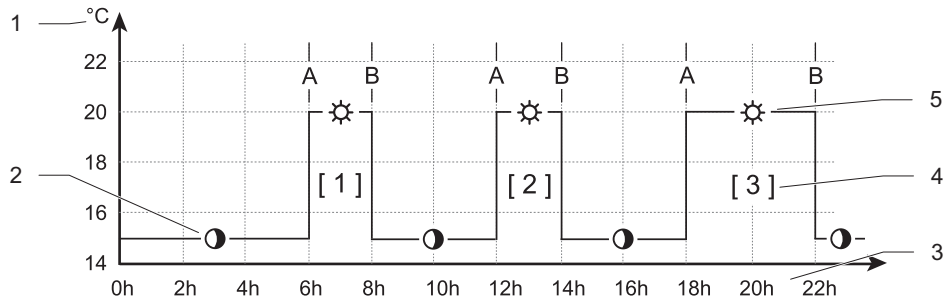

Legend

- A** Start time of heating program
- B** End time of heating program
- 1** Temperature axis, temperature is
- ☾ "Eco" or ☀ "Comfort"

- 2** Heating to ☾ "Eco" temperature
- 3** Time of day
- 4** Zone of heating to "Comfort" temperature
- 5** Heating to ☀ "Comfort" temperature

Factory settings for time zones:

Time axis	Day of week / group of days	Switch-on time	Switch-off time
[1]	① ② ③ ④ ⑤ 6 7	06:00	22:00
	1 2 3 4 5 ⑥ 7	07:30	23:30
	1 2 3 4 5 6 ⑦	07:30	22:00
[2]	-	-	-
[3]	-	-	-





7.9.2 Setting the weekly heating program

- Hold the **prog** button pressed for about 5 seconds.

The time zone will start flashing „[1]“.





- Select the time zone you wish to program – use the **+** and **-** buttons to set the day of week of group of days proposed according to the following table („[1]“, „[2]“ nebo „[3]“).
- Press the **prog** button and using the **+** and **-** buttons select the day of week or group of days proposed to select the following table:

Whole week	① ② ③ ④ ⑤ ⑥ ⑦
From Monday to Friday	① ② ③ ④ ⑤ 6 7
Weekend	1 2 3 4 5 ⑥ ⑦
For each day of the week	① , ② , ③ , etc.

- Press the  button and using the  and  buttons select the start and end times of the time zone.
- Press the  button again and set the following time zone.
- Repeat the previous programming steps.
- To exit the programming menu press the  button and hold it for about 10 seconds.

Displays the general display screen.

7.10 Hot water heating weekly program

- For system boilers with attached external hot water tank or combination boilers with flow-through water heating with hot water exchanger preheating option (COMFORT function).
- Hold the  button pressed until the display changes. Using the  button select the  symbol.
- Press the  button to continue.

7.10.1 Example of a 7 day heating programme - domestic hot water tank loading or preheat

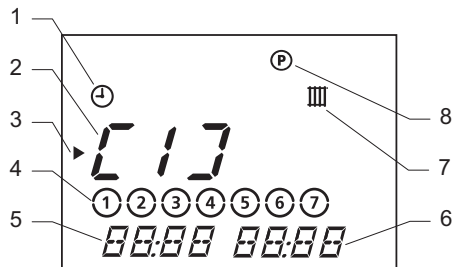

Legend

- 1 Selected operating mode
- 2 "Tank loading or preheat" time zone
- 3 Cursor (shows the value to be changed)

- 4 Day or group of days
- 5 Start time of heating program
- 6 End time of heating program
- 7 Programming the heating time zones
- 8 Programming menu

You can select up to 3 time zones for "Tank loading or preheat".

Examples of combinations:

- [1]: whole day
- [1]: morning and [2]: evening
- [1]: morning, [2]: lunch and [3]: evening

Important! These three time zones must not overlap.

At the flow-through water heating boilers, the preheating must be activated to make the control unit able to turn it off.

Example of tank heating or the hot water exchanger preheating weekly program

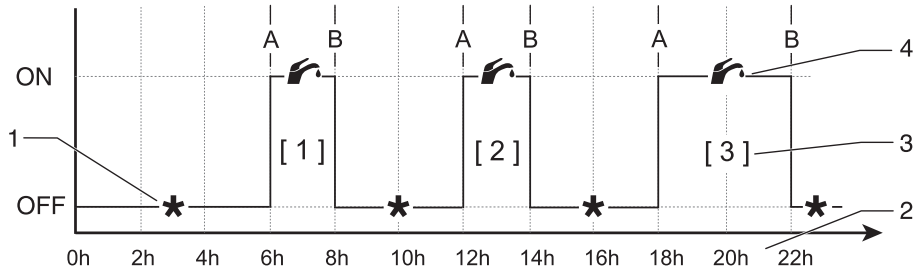

Legend

A Start time of program

B End time of program

1 Domestic hot water heating OFF
„Tank loading or preheat“

2 Time of day

3 „Tank loading or preheat“ time zone

4 Operating domestic hot water heating ON

Factory settings for time zones:

Time axis	Day of week / group of days	Switch-on time	Switch-off time
[1]	①②③④⑤ 6 7	06:00	22:00
	1 2 3 4 5 ⑥ 7	07:30	23:30
	1 2 3 4 5 6 ⑦	07:30	22:00
[2]	-	-	-
[3]	-	-	-

7.10.2 Setting the 7 day hot water heating programme

- Hold the **prog** button pressed for about 5 seconds. Using the **+** button select

the **☒** symbol. The time zone will start flashing „[1]“.

- Select the time zone you wish to program – use the **+** and **-** buttons to set the day of week of group of days proposed according to the following table („[1]“, „[2]“ or „[3]“).
- Press the **prog** button and using the **+** and **-** buttons select the day of week or group of days proposed to select the following table:

Whole week	①②③④⑤⑥⑦
From Monday to Friday	①②③④⑤ 6 7
Weekend	1 2 3 4 5 ⑥⑦
For each day of the week	①, ②, ③, etc.



- Press the **prog** button and using the **+** and **-** buttons select the start and end times of the time zone.
- Press the **prog** button again and set the following time zone.
- Repeat the previous programming steps.
- To exit the programming menu press the **prog** button and hold it for about 10 seconds.

Displays the general display screen.

7.11 Temporary override

Note:

- This setting is possible in the automatic heating mode **↓**.
- This modification permits temporary adjustment of the set room temperature until another change of temperature is made in the heating program (see following example).



Example of temporary adjustment of set room temperature:

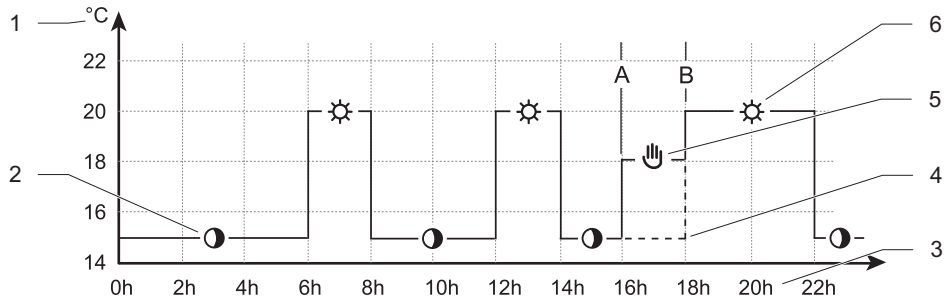

Instructions for Use

Legend

- A** Start time of temporary temperature adjustment
- B** End time of temporary temperature adjustment
- 1** Temperature axis, temperature is "Eco" or "Comfort"

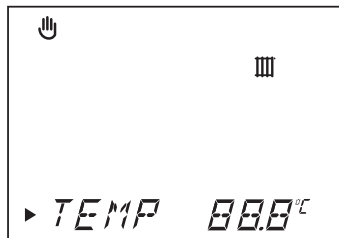

- 2** Heating to „Eco“ temperature
- 3** Hours of day
- 4** Start of heating to "Comfort" temperature
- 5** Temporary temperature adjustment
- 6** Heating to "Comfort" temperature

- In the general display screen use the \oplus and \ominus buttons to display the set room temperature. Symbol  is displayed and the previous temperature setting flashes.



- Using the \oplus and \ominus buttons to set the temporarily required room temperature

The set temperature flashes.

 	Temporary setting of room temperature (°C)
Minimum	8
Maximum	30

The setting is saved:

- **automatically after 10 seconds:** general display screen is shown,
- **or after pressing the mode button:** subsequent display screen is shown.

Upon another change of the temperature in the heating system the symbol  stops being displayed.

- Press the mode button for cancellation



of the temporary temperature adjustment.
Symbol is displayed.

After 3 seconds the general display screen is displayed and symbol goes out.

7.12 Information menu

This menu lets you display various thermostat settings.

- In the general display screen press the button repeatedly until the following information is displayed:

Symbol is displayed.

- The display shows the “Comfort” heating temperature.

- The display shows the “Eco” heating temperature.
- The display shows the hot water setting value.
- The display shows the heating program time zones.
- The display shows time regions for HoW tank heating (exchanger preheating).
- The display shows the date (if the “annual calendar” is activated).
- The display shows the thermostat name.



8 Troubleshooting

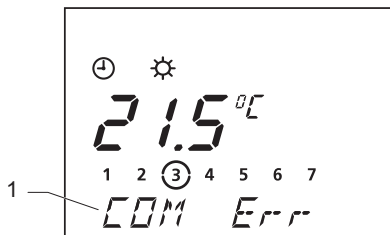

Legend

1 Multifunctional display area

In the event of a fault, the thermostat displays error messages in the multifunctional display area (1).

Warning!

Never try to service or repair the appliance by yourself. Let an installation and service company to remedy the fault.

Fault	Cause	Corrective action
The display is off.	Electric supply failure.	Check the mains power supply is on and that the appliance is switched on at the spur or socket. The appliance starts automatically once the power supply is on. If the fault persists, please contact a skilled professional.
Room temperature does not reach the temperature programmed.	Poor adjustment of thermostatic valves on the radiators.	Check that the thermostatic valves of the radiators in the room where the appliance is installed are set to maximum. If this is correct, please contact a skilled professional.
<i>COM Err</i>	Communication error between the boiler and the appliance.	Please contact a skilled professional.
<i>BMU Err</i>	Boiler fault	Please contact a skilled professional.
<i>Other faults</i>	-	Please contact a skilled professional.

Instructions for Use



9 Frost protection

The frost protection system activates the boiler when:

- The ambient temperature in the room where the appliance is installed falls below 3 °C.
- The “Holiday” function  is activated in your absence (see chapter “Holiday” function) for a certain period.
- Set the thermostat to the absence status *OFF* .
- If you leave home for a long period, consult the boiler manual.





Instructions for Use





Installation and servicing Index

1	Comments on the instructions	34	6	Electrical connection	42
2	Appliance Description	34	7	Commissioning	43
2.1	CE marking	34	8	Adjustments	45
2.2	Block diagram	35	8.1	Recommended settings during installation	45
3	Appliance location	36	8.2	Recommended after-sale settings	48
4	Safety instructions and re- gulations	38	9	Check / Commissioning	50
4.1	Safety instructions	38	10	User information	50
4.2	Safety regulations	38	11	Appliance replacement	51
5	Appliance installation	39	12	Technical data	52
5.1	Dimensions	39	13	Outside sensor	53
5.2	Appliance package contents ..	40			
5.3	Opening the appliance	40			
5.4	Fixing appliance to a wall	41			

1 Comments on the instructions

- Please give all of the instructions to the user. The user shall keep them for future reference.

The manufacture accepts no liability in case of damage due to the non-compliance of the instruction manual.

2 Appliance Description

2.1 CE marking

The CE mark on this appliance shows compliance with:

- Directive 89/336/EEC on the approximation of the Laws of Member States relating to electromagnetic compatibility.
- Directive 73/23/EEC on the harmonisation of the Laws of Member States relating to electrical equipment designed for use within safe voltage limits.

2.2 Block diagram

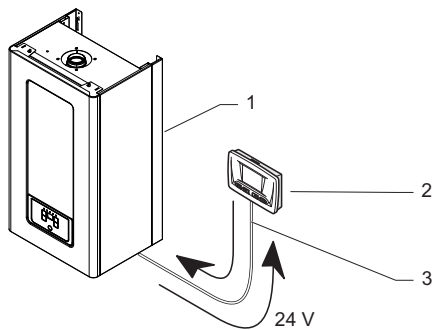

Legend

- 1 Boiler
- 3 Programmable room thermostat
- 4 Supply 24V



3 Appliance location

- Do not install the appliance above another appliance that could damage it (for example, above a cooker that might emit steam or grease) or in a room, which has a lot of aggressive dust in the atmosphere.
- The appliance must be installed in a room protected from freezing temperatures. Take the necessary precautions.
- Install the control in such a manner so as to guarantee optimum measurement of the ambient temperature by positioning it:
 - On inside wall in the main room of the house.
 - Approximately at 1.5 metres from the ground.
- Do not install the appliance:
 - Near heat sources such as radiators, televisions, sunlight, etc.
 - On cold walls.
 - Between furniture, behind curtains, or other objects that could effect measurement of ambient air temperature in the room.
 - Close to draughts of air that could come from doors or windows.
- Explain these requirements to the home owner.



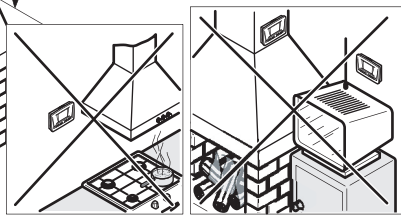
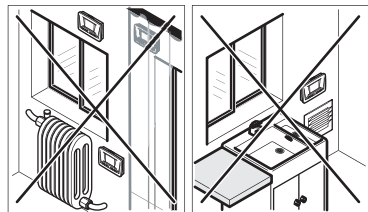
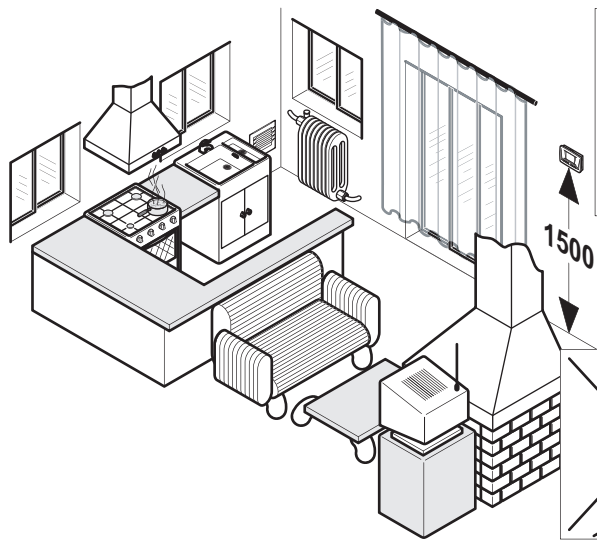

Installation and servicing



4 Safety instructions and regulations

This appliance is tested and certified for safety and performance. It is, therefore, important that no alteration is made to the appliance, without written permission from the manufacturer.

Any alteration not approved by the manufacturer may result in invalidation of the certification, appliance warranty and may also breach valid laws.

4.1 Safety instructions

Warning! Incorrect installation can cause electric shock or appliance damage.

- Protect all the electrical components from water when you carry out any work.

4.2 Safety regulations

When installing and commissioning the appliance, the regulations below shall be observed in their current version.

The installation of this appliance must be carried out by a competent person in accordance the rules in force in the countries of destination. Manufacturer's instructions must not be taken as overriding statutory requirements.



5 Appliance installation

5.1 Dimensions

All the dimensions in this chapter are expressed in mm.

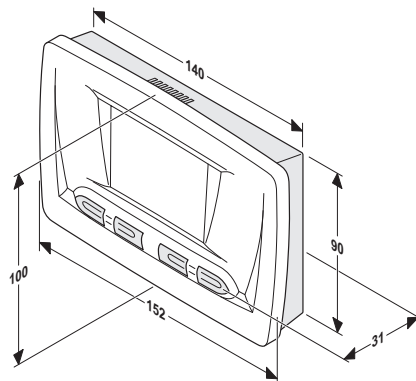

Installation and servicing

5.2 Appliance package contents

The Thermolink P thermostat is delivered with:

- 1 Instructions for Use,
- 1 plastic bag containing 2 screws and wall plugs.

5.3 Opening the appliance

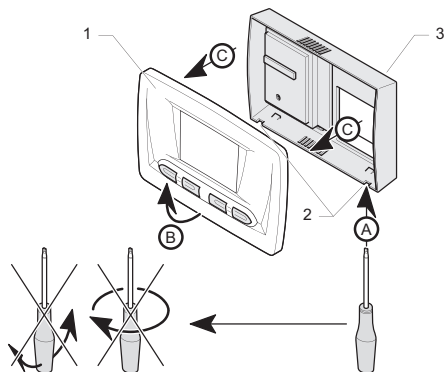

Legend

- 1 Front panel
- 2 Mouldings
- 3 Appliance box

- Remove the front cover (1) from the appliance box (3) respecting the order of operations (A) to (C).

5.4 Fixing to a wall

- Make sure you use suitable tools for installation works.
- Chose the location of the appliance. See chapter “Appliance location”.
- Position the appliance box (5) on a wall.
- Drill the holes (4) for the attachment screws in line with the 2 pre-moulded attachment holes (1) in the appliance box.

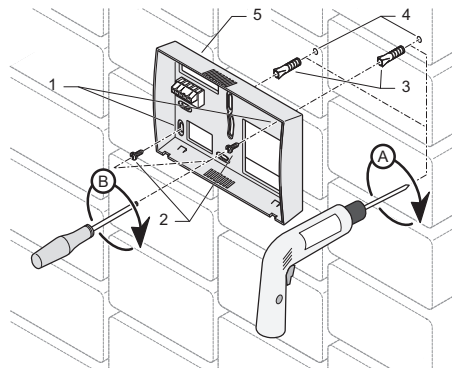

Installation and servicing

Legend

- 1 Attachment holes in appliance box**
- 2 Attachment screws**
- 3 Wall plugs**



4 Predrilled holes

5 Appliance box

- Insert the wall plugs (4) in the drilled holes.
- Proceed with connecting the appliance as per chapter „Electrical connection“.
- Secure the appliance box to the wall using the attachment screws (2) as illustrated on the previous page.
- Replace the front cover on the appliance box.

6 Electrical connection

6.1 Connection to boiler

Important: An installation and service company or appropriately qualified electrician should make the electrical connection to the appliance.

- Use a connection cable that complies with the specifications given at the end of this manual (see chapter „Technical data“).

Important!

The outdoor sensor cable and room control unit cable must not be installed in parallel with power cables.



- Do not remove the link wire from the „Room thermostat“ connection terminal of the main board of the boiler.

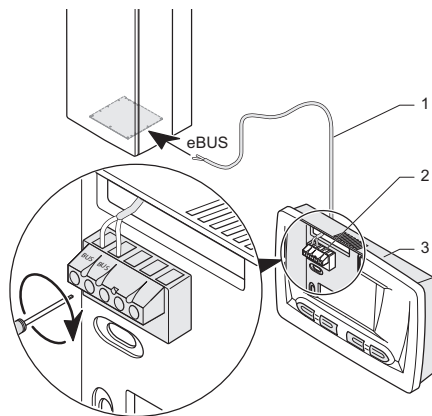

Legend

- 1 Connection cable to boiler (*)**
- 2 Room thermostat connection terminal**
- 3 Room thermostat**
- (*) Not delivered with thermostat**

- Connect the cable (1) to the appliance (2) as illustrated.
- Connect the cable (1) to the eBUS terminal of the boiler as illustrated.

7 Commissioning

- Put the boiler into operation.
- Fully open the thermostatic valves in the room where the room thermostat is located.



Important:

- The Thermolink P control unit is factory set to the modulation mode. In that case the boiler works as if its output is modulated.
 - If requested, the modulation mode must be selected before the control unit starts modulating the boiler's performance and the set room temperature in the building has been reached.
- 

Caution: In case the room control unit is connected, the maximum temperature of the HoW and heating water (HeW) must be selected on the boiler control panel. Under these conditions the temperature set at the boiler serves as a limit value.

Example: HeW temperature is calculated at 65°C by the equithermal regulation. At the boiler control panel however, a lower temperature is set, e.g. 55°C. In that case, the boiler heats the HeW only up to the 55°C.

Maximum HeW temperature must be set with regard to a given heating system (e.g. floor heating).





8 Adjustments

Modification of certain thermostat parameters can increase reliability and prevent malfunction in the future.

8.1 Recommended settings during installation

To ensure that the thermostat works at peak performance, several values must be preset.

- Press the **(mode)** button for 10 seconds to enter the settings menu.
- When  and "CODE 00" is displayed use the **+** and **-** buttons to set "CODE 96" on the display.

- Confirm by pressing **(mode)**.
- When first menu "COMF" starts flashing, use the **+** and **-** buttons to set the required "Comfort" temperature value.
- Press **(mode)** for saving and presetting another parameter (see following Table).
- To save all preset values press and hold **(mode)** for 10 seconds.

The display will return to the general display screen after being idle 1 minute or after pressing and holding **(mode)** for 10 seconds.



Menu	Title	Action / Information
<i>COMF</i>	Presetting the "Comfort" heating temperature	Select a value between 5 °C and 30 °C. (factory setting: 20 °C)
<i>ECO</i>	Presetting the "Eco" heating temperature	Select a value between 5 °C and 30 °C. (factory setting: 15 °C)
<i>SAN</i>	Setting hot water temperature	Select a value between 38 °C and 65 °C. (factory setting: 60 °C)
<i>MOD</i>	Selecting thermostat mode	Select value: 0 = without modulation ► mode ON/OFF 1 = with modulation ► automatic calculation of heating setting (factory setting) Caution: When an outdoor temperature sensor is connected to the boiler, modulation mode is automatically selected. Selection of other mode is disabled, two dashes are displayed instead of a parameter.

Menu	Title	Action / Information
P7.P1	Select 24h or 7 day programming	Select between P1 and P7: P1 = daily programming P7 = weekly programming (factory setting)
COMP	Selecting heating curve (*)	Select a value between 0.2 and 4. (factory setting: 1.2) To make this setting see the manual for the outside sensor connected to the boiler.
DATE	Annual calendar activation	Select a value: 0 = off (factory setting) 1 = on
<i>(*) Displayed only if outside sensor is connected to the boiler.</i>		

Note: To reset the factory settings hold the **mode** button pressed for 20 s.

The display will then flash 3x and all values will return to the original factory settings.

8.2 Recommended after-sale settings

- Press the **(mode)** button for 10 seconds to enter the settings menu.
- When and  a „CODE 00“, s displayed use the **⊕** and **⊖** buttons to set „CODE 35“.
- Confirm by pressing **(mode)** . The first menu „CH On“ will be displayed.
- Press **(mode)** for saving and presetting another parameter (see following Table).
- Use the **⊕** and **⊖** buttons to set the required value.
- To save all preset values press and hold

(mode) for 10 seconds.

The display will return to the general display screen after being idle 1 minute or after pressing and holding **(mode)** for 10 seconds.

Menu	Title	Action / Information
<i>CH On</i>	Extra heating	Request for heating to 50 °C is simulated. Boiler burner and pump are switched on.
-	-	All display segments are displayed.
<i>VERS</i>	Program version	The current program version is displayed.
<i>CTIN</i>	Correction of thermostat ambient temperature	Enables adjustment of the displayed temperature by ± 3 °C. (factory setting: 0)
<i>CTEX</i>	Correction of outside temperature	Enables adjustment of the displayed temperature by ± 5 °C. (factory setting: 0)
<i>(*) Displayed only if outside sensor is connected to the boiler.</i>		



9 Check / Commissioning

Once the appliance is installed, check whether it runs:

- Check that the thermostat is installed in compliance with the Instructions for Use and it works.
- Check that the thermostat and connected equipment for safety, settings and operating state.
- Increasing the temperature on display of control unit above the current room temperature will switch the boiler on.
- Decreasing the temperature on display of control unit below the current room temperature will switch the boiler off.



10 User information

The user should know how to use the appliance.

- Explain the user the appliance operating principles and demonstrate if required.
- Have a look at the operating instructions together and answer any questions if need be.
- Give the user all of the manuals and documents concerning the appliance and tell the user to keep them near the appliance.
- Explain more precisely the safety principles they should observe.



11 Appliance replacement

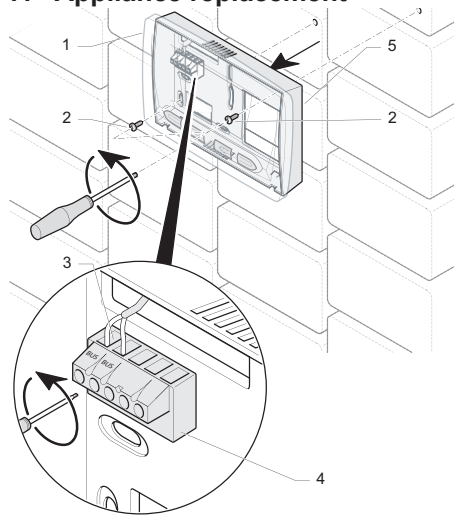

Legend

- 1 Appliance front panel
- 2 Attachment screws
- 3 Connection cable to boiler
- 4 Terminal
- 5 Appliance box

- Disconnect the power supply.
- Remove the front panel (1).
- Using a screwdriver, disconnect cable (3) from the terminal (4).
- Using a screwdriver, unscrew the attachment screws (2), which hold the appliance box (5) to the wall and remove the box.
- Prepare a new thermostat for installation (see chapter “Thermostat installation”).

12 Technical data

Description	Unit	
Max room temperature in the room where the control is installed	°C	50
Dimensions:		
Height	mm	100
Width	mm	152
Depth	mm	31
Power supply voltage	V	24
Electrical rating	mA	17
Min. diameter of electrical connection cables	sq.mm	2 x 1,5
Max. length of electrical connection cables	m	300
Electrical protection		IP 20
Electrical category		II



13 Outside sensor* - optional accessories (*)Not delivered with thermostat

13. Sensor location

- The outside sensor should be located on the north/northwest wall of the building.
- For optimal indication of outside temperature for 3-storey or lower buildings, the sensor should be located on the wall at about 2/3 of the building height. For higher buildings a position between the 2nd and 3rd floor is recommended.
- When installed, the outside sensor should not be protected against wind, but should also not be exposed to draught.

Also, it should not be exposed to sunshine.

- The outside sensor should be located at least 1 m from openings in the outside walls and away from constant or random sources of hot air.



13.2 Equithermal curves

Graph with heating curves for required room temperature 20 °C.

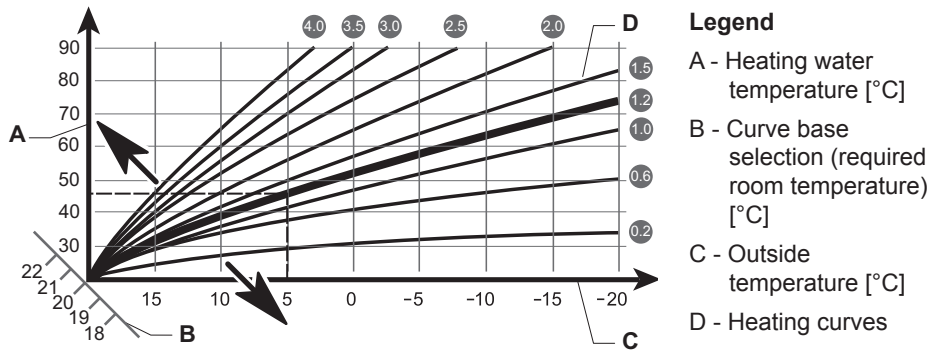

12.3 Setting the control unit with outdoor sensor connected – example

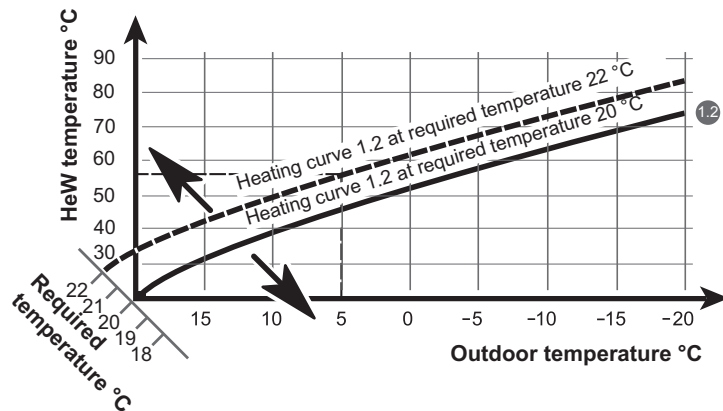

Example: If a heating curve 1.2 is selected and a different temperature than 20 °C is required for the heated room, e.g. 22 °C, the heating curve is shifted as shown (see picture). The selected heating curve 1.2 is shifted in parallel at a 45° angle on the “B” axis. Hence for required room temperature of 22 °C and outdoor temperature of 5 °C, HeW temperature is automatically calculated at about 56 °C.

Caution: If the required temperature is not reached in the room, or the temperature rises too slowly, please select a heating curve of a higher number.

12.4 Outdoor sensor value table

Temperature (°C)	Negative thermal coefficient
-25	2167 Ω
-20	2076 Ω
-15	1976 Ω
-10	1862 Ω
-5	1745 Ω
0	1619 Ω
5	1494 Ω
10	1387 Ω
15	1246 Ω
20	1128 Ω
25	1020 Ω
30	920 Ω
35	831 Ω
40	740 Ω

12.5 Outside sensor curve

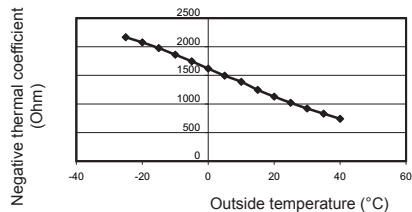

12.6 Outdoor sensor deviation

The negative thermal coefficient value must be in the following intervals:

-20 °C < outside temperature < 25 °C →
+/-0,8K

-40 °C < outside temperature < -20 °C or
25 °C < outside temperature < 40 °C →
+/-2K

12.7 Outside sensor parts

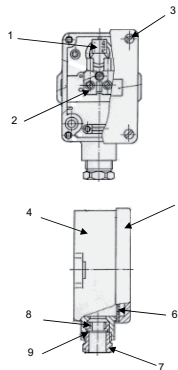

	Description	Qty
1	Sensor	1
2	Bipolar connection terminal	1
3	Stainless screws	4
4	Plastic box	1
5	Plastic cover	1
6	Seal	1
7	Cable gland	1
8	Rubber O-ring	1
9	Metal washer	1

12.8 Connection and technical parameters of sensor

Outdoor sensor is connected to the boiler control board right to the dedicated terminal box (Outdoor NTC) with a twin core cable with minimum 2×1.5 sq.mm cross section.

Nominal voltage	5 V
Power consumption	< 10 mW
Electrical category	II
Electrical protection	IP 44



www.protherm.eu

Protherm spol.s r.o.
Pplk. Pljušťa
909 01 Skalica
Tel.: +421 34 6966 101
Fax: +421 34 6966 111

Your service:

