

Bear 20 (30, 40, 50) KLZ

The boiler's Serial no. is shown on the plate which is attached to the rear side of the control panel. The control panel is accessible after removing the front cover.

In the section "Operating Instructions" you will find description of the boiler's main functions and guidelines on how to handle the boiler safely. The section "Installation Instructions" is for skilled workers only.

Table of contents

Introduction.....	2
OPERATING INSTRUCTIONS	
Controls and signals.....	4
Selecting Read mode	5
Selecting Setup mode	5
Schematic diagram of boiler control	7
Error codes	8
Starting up and shutting down boiler	9
Boiler control.....	9
Protection functions.....	10
Service and maintenance.....	11
Warranty and warranty conditions	12
Technical specifications	13
Connection dimensions	15
Schematic diagram of boiler.....	16

INSTALLATION INSTRUCTIONS

Introduction.....	17
Delivery completeness	20
Preparing for boiler installation	21
Installing the boiler.....	23
Operating the boiler.....	25
Service modes.....	27
Electrical connection of boiler.....	28
Converting to different fuel	29
Electrical wiring diagram.....	31

Introduction

1. The boiler and all the associated equipment must be installed and used in accordance with the installation design, all the corresponding valid legal prescriptions and technical norms and with the manufacturer's instructions.
2. The boiler may be installed only in an environment for which it is designed.
3. After installation, the boiler may be put into operation by an authorised service organisation only.
4. The boiler complies with the prescriptions valid in the Slovak Republic. When used in the conditions of other countries, any applicable deviations must be identified and addressed.
5. In the event of a defect call the manufacturer's service organisation – any unauthorised intervention may damage the boiler (and possibly also associated equipment!).
6. The service technician putting the boiler into operation for the first time is obliged to familiarise the user with the safety elements of the boiler, their characteristics and with the relevant required response of the user, with the fundamental parts of the boiler and manner of use of the boiler. If this technician is also delivering the boiler, he/she must ensure that the original packaging of the boiler is available for potential further transport thereof until the moment of launch into operation.
7. Check whether the delivery is complete.
8. Check whether the model and type supplied corresponds to the type required for use, i.e. check whether the data relating the boiler settings stated on the plate correspond with the data relating to the local network supplying fuel (gas) to the place of installation, or have this performed by a professional technician who shall install the boiler or put it into operation.
9. Whenever you are not sufficiently certain of how to control the boiler, seek out and study all the corresponding instructions in this Operation and Installation Guide carefully and proceed accordingly.
10. Never remove or damage any markings and signs on the boiler. Also store the original packaging of the boiler in an undamaged condition for potential further transport in the case that the boiler is not put into operation.
11. . . . When performing any repairs, only original parts may be used. It is prohibited to make any changes to the boiler's internal installation, or to interfere with this in any way.
12. . . . When shutting the boiler down for a longer period of time, we recommend that you close the gas supply and disconnect the boiler from the electricity network. This recommendation applies in conjunction with the general conditions stipulated in this Operation and Installation Guide.
13. At the end of its useful life, the boiler or its parts must be disposed of ecologically, in a manner which avoids causing any harm to the environment.
14. . The manufacturer is not liable for and provides no warranty for damages caused by the failure to abide by:
 - the conditions stipulated in this Operation and Installation Guide;
 - prescriptions and norms;
 - proper installation and operation procedures;
 - conditions stated in the Warranty Certificate and the Service Book.
15. . If the boiler is delivered to the user by the technician who also installs the boiler, this technician is also obliged to present to the user all the accompanying documentation for the boiler (in particular

the Operation guide, Service Book etc.). If the boiler is not put into operation, the original packaging of the boiler must be available for the potential further transport thereof.

Safety of equipment and people

- According to the findings of the SZÚ Brno (National Testing Institute), the boiler (as well as all its optional accessories) complies with the requirements of European Directive 90/396/EEC on gas-fuelled appliances and European Directive 92/42/EEC on efficiency, the European Directive 2006/95/EC on electrical means of operation for use in certain voltage ranges and the European Directive 89/336/EEC on electromagnetic compatibility.
- The appliance is also approved according to the European norms EN 677, EN 625, EN 60335-01, EN 50165, EN 55014, EN 61000-3-2 and EN 61000-3-3.
- In order to operate and handle the boiler in accordance with the purpose for which it is designed in actual conditions of use (hereafter referred to only as use), it is necessary to abide also by additional conditions – the most essential of which (i.e. those which must not be omitted) are found in the following regulatory documents:
 - in the design area: STN 06 0310 and STN 06 0830;
 - in the fire safety area: STN 92 0300;
 - for installation and fitting (and repairs): STN EN 1755 or STN 38 6460, as applicable STN 38 6462, Decree no. 48/1982 Coll. (as amended by the later prescriptions) and the binding occupational health regulations;
 - in time of running and operation: STN 38 6405.
 - in the area of discharge of combustion gases and air inflow STN EN 483, company material – “catalogue of dual piping for discharge of combustion gases and inflow of combustion air designated

for type C gas appliances, i.e. in closed “TURBO” version

- In addition to the above mentioned documents, it is necessary when using the boiler to proceed in accordance with this Operation and Installation Guide and the accompanying boiler manufacturer’s documentation. During use of the boiler any handling by children, persons under the influence of intoxicating substances, non-certified persons, etc. must be prevented.

In practice situations may arise in which the following essential measures must be adopted:

- prevent the boiler from (even accidentally) being switched on while conducting inspections or working on the combustion gases flue route or gas and water distribution pipes by disconnecting the boiler from electrical power supply also by other means than only using the main switch (e.g. by pulling the power cord plug out of the power socket);
- shut the boiler down every time when there are any (even temporary) flammable or explosive fumes present in the area from which combustion air is supplied to the boiler (e.g. from paint when painting, laying and spraying molten substances, from gas leaks, etc.);
- if it is necessary to drain water from the boiler or from the whole system, the water must not be dangerously hot;
- in the case of a water leak from the boiler’s heat exchanger or when the exchanger is clogged up with ice, do not attempt to start up the boiler until normal operating conditions have been restored;
- when a gas leak has been detected or the gas supply has failed, or in the case of suspicion that this has occurred, shut the boiler down, turn the gas supply off and call the gas board or a service organisation.

*e.g. TPG 800 01

Operating instructions

Controls and signals

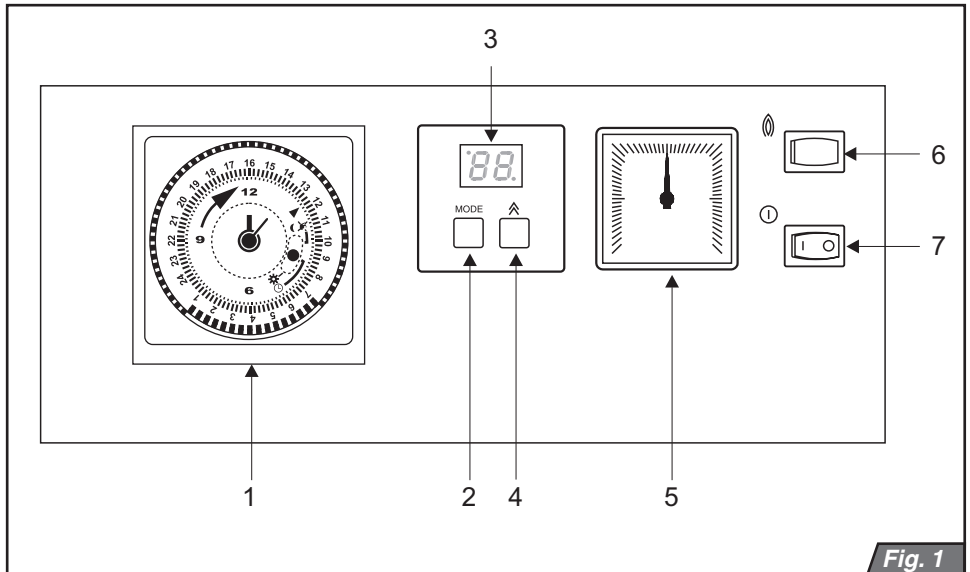

Fig. 1

Main switch

The main switch (Fig. 1, Position 7) is used to switch the boiler on or off. The main switch is situated on the right side of the boiler control panel.

Caution: The boiler must be put into operation and switched on for the first time by an authorised service organisation!

Control panel

On the boiler's control panel you can monitor current values and set the required parameters.

The control panel has the following control elements (Fig.1):

- 1 Timer switch – sets attenuation of tank heating and attenuation of heating water.
- 2 MODE button – transition into setting mode.
- 3 Display panel.
- 4 button.
- 5 Pressure gauge – displays pressure of heating water.
- 6 RESET button – to unblock errors.
- 7 Main switch – switches boiler on and off.

Selecting Read mode

Displaying heating water temperature



After turning the boiler on by pressing the main switch, the current temperature of the hot water will appear on the display.

Displaying hot water temperature



After pressing the \blacktriangle button, the temperature of the heating water in the tank will appear on the display. In this

display the diode is lit in the upper left-hand corner, which indicates the value of the current hot water temperature in the tank. If the parameter "--" appears on the display instead of a numerical value this means that the boiler is not in priority hot water heating mode but is only warming the heating water into the system.

Selecting Setup mode

Setting hot water temperature



Press the MODE button – the diode in the upper left-hand corner of the display flashes and the diode in the lower right-hand corner is lit. Use the

\blacktriangle button to set the required temperature of hot water in the tank. The setting range of hot water values is --, 40, 44, 48, 52, 56, 60, 64, 68, 70°C. On setting the parameter -- the boiler warms only the heating water into the heating system. By pressing the MODE button the selected value is saved into the memory and the mode for setting the heating water temperature appears on the display.

Note: Switch between the display of the current temperature of the heating water and the temperature of the hot water in the tank using the \blacktriangle button.

Other values on display

Without regard to displaying the temperature of the hot water and temperature on the heating water, one of the following statuses is signalled by means of the diode in the lower right-hand corner:

- diode not lit – no requirement for burning
- diode flashing – requirement for burning from tank (requirement for additional heating of hot water in tank)
- diode lit – requirement for burning from room control unit

Displaying heating water pressure

Pressure of heating water in the boiler is displayed constantly on the analogue pressure gauge (fig 1, position 5).

Setting heating water temperature



In the heating water setting mode, the diode in the upper left-hand corner of the flashes and the diode in the lower

right-hand corner is not lit. Use the \blacktriangle button to set the required temperature of heating water into the system. The setting range of heating water values is --, 45, 50, 55, 60, 65, 70, 75, 80, 85°C. On setting the parameter -- the boiler warms only the hot water in the tank – the boiler works in "summer mode". By pressing the MODE button the selected value is saved into the memory.

Equithermal mode

Setting the equithermal mode, i.e. selection of the equithermal curve slope and parallel shift of the curve, is possible only in the case that an outdoor sensor is attached to the boiler.

Note: If no outdoor sensor is attached, the boiler will not enable the user to transfer to setting mode E and P.

Setting curve slope



Press the MODE button until the parameter E appears on the display. At the same time the diode in the upper left-hand corner flashes. Using the \blacktriangle button set the required curve E1 – E9 and subsequently confirm selection by pressing the MODE button. In the case of selecting the parameter E- the equithermal mode is switched off. The required output temperature of the heating water from the boiler has a value according to the outside temperature and the relevant set curve (Fig. 2).

Parallel curve shift

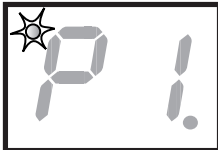

Press the MODE button until the parameter P appears on the display. At the same time the diode in the upper left-hand corner flashes. Using the \blacktriangle button set the required curve P1 – P9 and subsequently confirm selection by pressing the MODE button.

Value shift of individual curves:

- P1 - posun o -15 °C
- P2 - posun o -9 °C
- P3 - posun o -6 °C
- P4 - posun o -3 °C
- P5 - posun o +3 °C
- P6 - posun o +6 °C
- P7 - posun o +9 °C
- P8 - posun o +15 °C
- P9 - posun o +21 °C
- P- - no shift

Curve slope

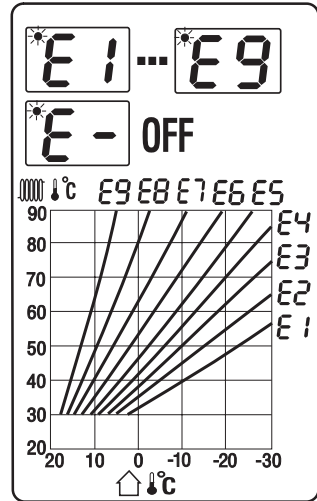

Fig. 2

Parallel curve shift

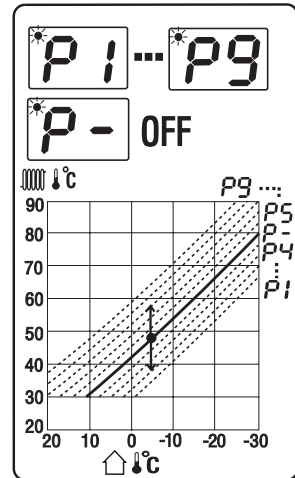
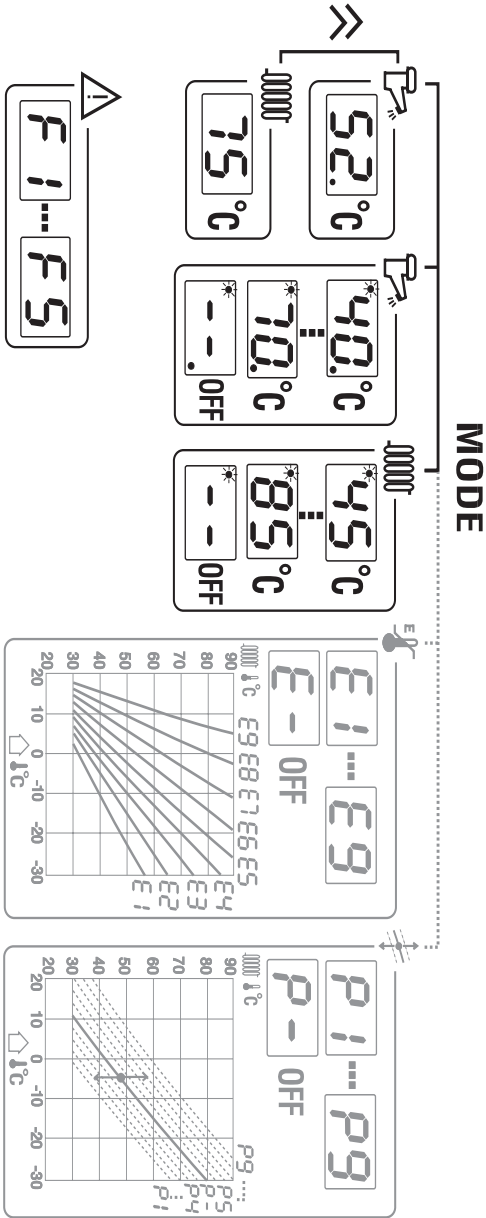

Fig. 3

The required temperature of the heating water according to the curve set in advance is reduced (P1 to P4) or increased (P5 to P9) by the set value, or remains without shift (P-).

Schematic diagram of boiler control



Valid only for connection of outdoor sensor

Fig. 4

Timer switch

The timer switch serves for setting attenuation of heating the hot water in the tank, i.e. during the interval of the set attenuation the boiler does not heat the water in the hot water tank to maintain temperature. The length of the attenuation interval is set by the cogs on the perimeter of the clock rotor. The interval is set to where the cogs face outwards – see diagram. There may be more than one interval, i.e. there may be a number of attenuations per day.

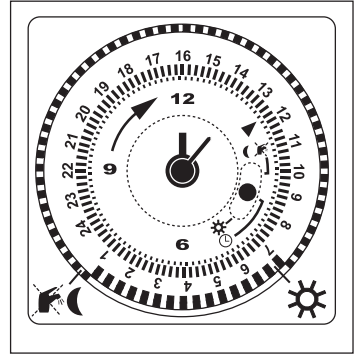

Error codes

No flame – F1

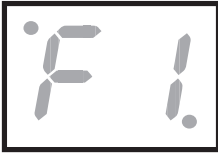

This signals automatic irreversible blocking of the automatic ignition and closure of the gas valve, i.e. LOSS OF FLAME. This

blocking occurs always in the mode when the gas valve is open and no feedback signal about the presence of the flame is sent. The boiler is switched off and cannot be started.

This fault however may be caused by intervention with the safety elements – emergency thermostat and combustion gas thermostat.

Press the RESET button (fig. 1, position 6) to unblock the fault. If the fault persists call an authorised service.

Sensor error – F2



This signals a fault of the heating water sensor or a drop in temperature of the heating water below 3°C. The boiler is

switched off and cannot be started. Call an authorised service.

Boiler overheated – F3

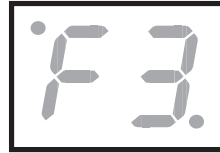

This signals a heating water temperature higher than 95°C. The boiler is shut down and restarts itself automatically after the water has cooled.

Sensor error – F4



This signals a fault of the hot water sensor. Heating of the hot water tank is blocked, whilst the mode of heating into the system is not affected by this fault.

Outdoor sensor error – F5



This signals a fault of the outdoor temperature sensor when equithermal boiler regulation is set. The boiler continues unlimited in its activity, but the heating water temperature is regulated according to the value set on the boiler (see “Setting heating water temperature”, page 5).

If the boiler is not in equithermal regulation mode this fault does not occur.

Starting up and shutting down boiler

Starting up the boiler

Important: Putting the boiler into operation and starting it up for the first time must be performed by an authorised service only!

If you wish to start the boiler up after it has been put into operation, make sure that:

- 1 the boiler is connected to the electrical power supply;
- 2 all stop valves (heating water, hot water, gas) underneath the boiler are opened;
- 3 the heating water pressure is lower than indicated on the pressure gauge – red adjustable hand (water in boiler must be cold).

Turn the main switch (Fig. 1, position 7) to the ON position (I). The boiler is ignited and heats the hot water in the tank. After this has been heated, the boiler heats the water in the heating system – if the heating water temperature is set and a command for heating is sent from the regulator.

In the event of a safety boiler shutdown an error code appears on the control panel (see “Error codes”, page 8).

Unblock the boiler by pressing the RESET button (fig 1, position 6). If the emergency shutdown recurs after a short time again, or if the boiler cannot be unblocked by pressing the RESET button, call an authorised service organisation.

Shutting the boiler down

The boiler can be shut down for shorter periods by switching off the main switch.

If the boiler is to remain shut down for a longer period of time, also remove the flexible power cord plug from the socket and close the gas inlet to the boiler. If there is no danger of the boiler freezing, water can be left in the boiler, in the opposite case it is necessary to discharge the water from the boiler and from the system. If the arrangement of the heating system enables this, upon disassembly of the boiler discharge water only from the boiler and leave water in the system so as to avert danger of corrosion.

Boiler control

Using the boiler without a room control unit

When running in this mode, the boiler maintains the selected heating water temperature. No room control unit is connected, the terminals for its connection must be mutually interconnected (standard factory setting).

Setting procedure:

- turn the main switch to the ON position;
- set the required heating water temperature on the control panel.

Using the boiler with a room control unit

The boiler maintains the selected heating water temperature. Switching of the terminals to the room control unit

connection is cancelled and the room control unit is connected. The boiler is switched on and off according to the internal temperature of the room in which the room control unit is installed. This room must not have thermostatic valves installed on heating radiators.

Important: On the control panel it is necessary to set the heating water temperature (temperature of the water in the system), which will be capable of covering thermal losses of the building even at low outdoor temperatures.

Note: Use control units recommended and supplied by the PROTHERM company, which are designated and tested for the given type of boiler. In the case of use of other regulators we do not guarantee the correct and full functioning of the boiler.

Operation of boiler with equithermal control

The boiler regulates the heating water temperature on the basis of outdoor temperature changes. In the case of this type of regulation it is necessary to set the equithermal curve according to the required heating water temperature. It is also necessary to attach an outdoor temperature sensor. The procedure for setting equithermal curves is outlined on page 6 of this manual.

Important: The room control unit and outdoor temperature sensor must be connected only by an authorised service.

Note: During all types of boiler regulation, heating of the hot water in the tank always has priority, i.e. when a command for heating the hot water is sent from the

tank, the boiler automatically switches to the mode of heating the hot water in the tank. After heating the hot water to the required temperature the boiler is automatically switched to the regime of heating the heating water into the system and continues in the heating system.

Setting boiler output

The factory setting of the boiler is to maximum output. In case of necessity it is possible to adjust the output of the boiler according to requirement (with regard to the properties of the boiler). In the case of heating the hot water in the tank up to the required temperature the boiler always works at full output.

Important: Change of setting of boiler output must be performed only by an authorised technician.

Protection functions

Continuous output modulation

This takes place on the basis of constant comparison of the actually attained values with the values requested (set) by the user; this regulation is proportional, i.e. in the case of a larger difference of compared values the boiler works with a higher output and vice versa.

Protection against freezing

When the temperature of the heating water drops below 8°C, the boiler is automatically started and heats the heating water.

Protection of hot water tank against freezing

When the hot water in the tank drops below 8°C, the boiler is automatically started and heats the tank. This function is active only in the case that heating of the hot water in the tank is switched off.

Pump protection

There is a possibility of blockage of the pump due to sedimentation of sludge in its bearings when the pump is idle for a

longer period of time. Switch the pump on for a short time when it has been in the room continuously for 24 hours.

Running down of pump

After the boiler is switched off by the room control unit the pump continues to ensure circulation of water in the heating system for approximately 1 minute (only in heating mode).

Anti-cycling

After the boiler has been shut down in heating mode it cannot be restarted sooner than 1 minute after shutdown and the temperature of the heating water drops by 8°C.

Note: This does not apply when the boiler has been switched off by the room control unit.

Protection against overheating

The pump is switched on always when the temperature of the heating water is higher than was set by the user, or if the temperature of the heating water is higher

than 85°C. The boiler is switched off when the temperature of the heating water is higher than 90°C (fault F3).

Running pump depending on heating water temperature

The boiler enables setting running of the pump after a certain selected temperature has been reached. This function can be set only by an authorised service technician.

Chimney draught control system

The boiler is equipped with a “Chimney draught control system” (CDCS). Upon an accumulation of combustion gases in the boiler, i.e. in the case of insufficient discharge of combustion gases, the CDCS is activated and the boiler switched off (inflow of gas into the boiler is shut off).

Power failure

Power failure will turn the boiler off. When power supply is restored, the boiler will automatically restart itself without losing any of the operating parameters settings.

If an error code appears on the display after electrical power supply restoration,

unlock the boiler using the RESET button.

Note: The boiler may be blocked as a consequence of overheating caused by the pump being switched off as a result of power failure. Rectify this fault by pressing the RESET button on the boiler control panel. If the fault persists call an authorised service.

Safety valve

The boiler is equipped with a safety valve with an opening pressure of 3 bar. **DO NOT TOUCH THE SAFETY VALVE!** Whenever the safety valve starts releasing heating water, switch off the boiler, disconnect it from the electrical power supply and call a service organisation. If the heating system repeatedly loses pressure, consult your service organisation.

Important: All the mentioned electronic protection functions are enabled only when the boiler is connected to power supply (the power cord plug is inserted into a power socket and the main switch is in the ON position (I)).

Service and maintenance

Maintenance of boiler by user

According to requirement the boiler casing is cleaned without removing the upper cover. Cleaning is performed when the boiler is disconnected from the electrical power supply by switching off the mains switch and removing the power cord plug from the socket. If the surface of the boiler is damp it can be switched back on only after it has dried.

It is necessary to check the water pressure in the heating systems once in a while and if necessary top up the water. Water can be added into the heating system after the boiler has cooled to less than 40°C (measured by the thermometer on the boiler). Failure to abide by this condition may result in leakage or cracks caused by

stress in the block of the boiler.

In the case of gas leakage it is necessary to shut down the boiler, close the gas valve and call a service organisation.

Protection against legionella

It is recommended that the hot water in the tank is either heated constantly to a temperature of 65°C or that the temperature of heating the hot water is increased at regular intervals to 70°C in order to eliminate the possibility of the spread of Legionella pneumophila bacteria or other types of bacteria.

Professional maintenance of boiler

Once per year, preferably before the beginning of the heating season, we recommend that the boiler is checked and set by a service organisation. This check is not covered by the boiler's warranty. The specific tasks to be performed are specified in the Service Book.

This mostly concerns tasks such as checking the function and state of the burner, checking and setting output, checking the tightness of connections of the flue conduit, checking the boiler exchanger, checking the hot water tank and checking the state of the magnesium electrode.

In this it is particularly important to verify the functional capability of the safety valve and also verify the activity of the emergency and combustion exhaust thermostat. This check is performed upon every service intervention on these elements.

We recommend that the state of the magnesium electrode is checked within six months of putting the boiler into operation. Deterioration of the electrode depends on the composition and hardness of the water. Longer time intervals for checking are stipulated by a professional service according to the degree of deterioration following the first check. If 60% of the electrode has been used up and the time interval is to remain same, the electrode

must be replaced with a new one. The tank must not be operated with a depleted electrode. The overall warranty of the boiler does not cover defects caused by corrosion in the case of a depleted magnesium electrode.

Note: The depletion of the magnesium electrode rod ensues from its protective function, and for this reason replacement thereof cannot be included within the warranty.

Warranty and warranty conditions

The PROTHERM Bear 20 (30, 40, 50) KLZ is covered by the warranty defined in the Warranty Certificate, the Service Book and by other conditions specified in this Operation Guide and Installation Guide (chapters Introduction and Boiler installation).

Technical specifications 20 (30) KLZ

Bear 20 KLZ

Bear 30 KLZ

Category	II _{2H3P}
Version	B _{11BS}
Ignition	electronic
Fuel	G20 / G31
Max. thermal input	[kW] 19 / 18
Min. thermal input	[kW] 13,5 / 12
Max. thermal output	[kW] 17 / 16
Min. thermal output	[kW] 12 / 11
Efficiency	[%] 90 - 92 / 89 - 91

Gas pressure

Supply pressure	[mbar] 18 / 30
Jet diameter	[mm] 2,65 / 1,7

Gas consumption

(Q max.)	2,0 [m³/h] / 1,6 [kg/h] . . . 3,0 [m³/h] / 2,0 [kg/h]
----------	---

Heating

Max. operating pressure	[bar] 3
Min. operating pressure	[bar] 1
Recommended operating pressure	[bar] 1 – 2
Temperature range	[°C] 45 – 85
Water volume in boiler	[l] 9,1
Expansion vessel	[l] 10
Max. pressure in expansion vessel	[bar] 3,5

Hot water

Max. supply pressure	[bar] 6
Adjustable temperature range	[°C] 40 – 70
Hot water tank capacity	[l] 110
Hot water flow (Di according to STN EN 625)	[l/min] 12,4

Electrical data

Voltage	[V/Hz] 230/50
Input (max.)	[W] 130
Prot. cover	IP 40
Current	[A] 0,5

Exhaust of combustion gases - method . . . into chimney

Flue diameter	[mm] 130
Combustion gas temperature	[°C] 88
Combustion flow mass	[g/s] 13,3
Min. required stable chimney thrust	[Pa] 2
Noise level (1 m from the boiler at height of 1.5 m)	[dB] up to 55
Dimensions – height / width / depth	[mm] 1385 / 505 / 892
Weight without water	[kg] 145

Technical specifications 40 (50) KLZ

	Bear 40 KLZ	Bear 50 KLZ
Category	II _{2H3P}	
Version	B _{11BS}	
Ignition	electronic	
Fuel	G20 / G31	G20 / G31
Max. thermal input	[kW] 38,5 / 36,5	49 / 47,5
Min. thermal input	[kW] 27 / 25,5	36 / 32,8
Max. thermal output	[kW] 35 / 33	44 / 41,2
Min. thermal output	[kW] 24,5 / 23	31,5 / 28
Efficiency	[%] 90 - 92 / 89 - 91	90 - 92 / 89 - 91

Gas pressure

Supply pressure	[mbar] 18 / 30	20 / 30
Jet diameter	[mm] 2,65 / 1,7	2,65 / 1,7

Gas consumption

(Q max.)	4,1 [m ³ /h] / 3,3 [kg/h]	5,2 [m ³ /h] / 3,8 [kg/h]
----------	--------------------------------------	--------------------------------------

Heating

Max. operating pressure	[bar] 3	
Min. operating pressure	[bar] 1	
Recommended operating pressure	[bar] 1 – 2	
Temperature range	[°C] 45 – 85	
Water volume in boiler	[l] 14,1	16
Expansion vessel	[l] 10	
Max. pressure in expansion vessel	[bar] 3,5	

Hot water

Max. supply pressure	[bar] 6	
Adjustable temperature range	[°C] 40 – 70	
Hot water tank capacity	[l] 110	
Hot water flow (Di according to STN EN 625)[l/min]	15,3	21

Electrical data

Voltage	[V/Hz] 230/50	
Input (max.)	[W] 130	
Prot. cover	IP 40	
Current	[A] 0,5	

Exhaust of combustion gases - method

Flue diameter	[mm] 150	180
Combustion gas temperature	[°C] 131	115
Combustion flow mass	[g/s] 31	50
Min. required stable chimney thrust	[Pa] 2	
Noise level (1 m from the boiler at height of 1.5 m)[dB]	up to 55	
Dimensions – height / width / depth	[mm] 1385 / 505 / 892	1385 / 590 / 892
Weight without water	[kg] 185	210

Connection dimensions of boiler 20 (30, 40, 50)KLZ

TYPE	a	b	c	e	ød
20 KLZ	327,5	191	505	177,5	130
30 KLZ	285	106	505	220	130
40 KLZ	242,5	21	505	262,5	150
50 KLZ	285	21	590	305	180

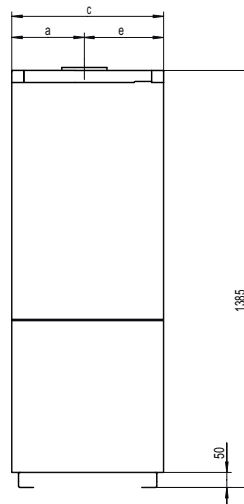
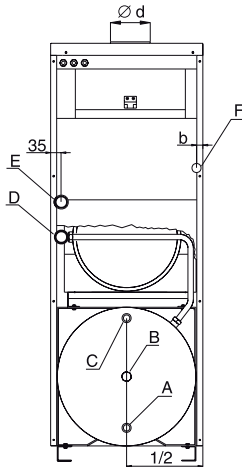
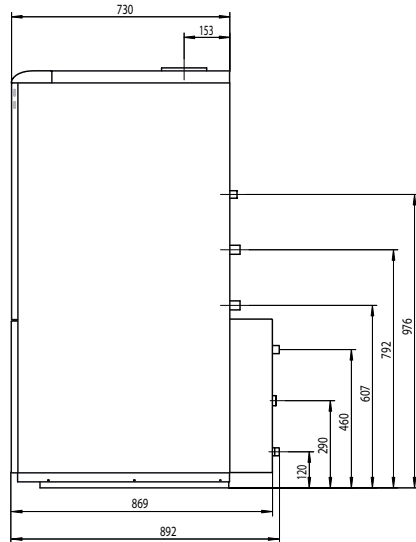

A – hot water input 3/4"
 C – hot water output 3/4"
 E – heating water output 1"

B – hot water circulation 3/4"
 D – heating water input 1"
 F – gas input 3/4"

Fig. 5

Schematic diagram of boiler

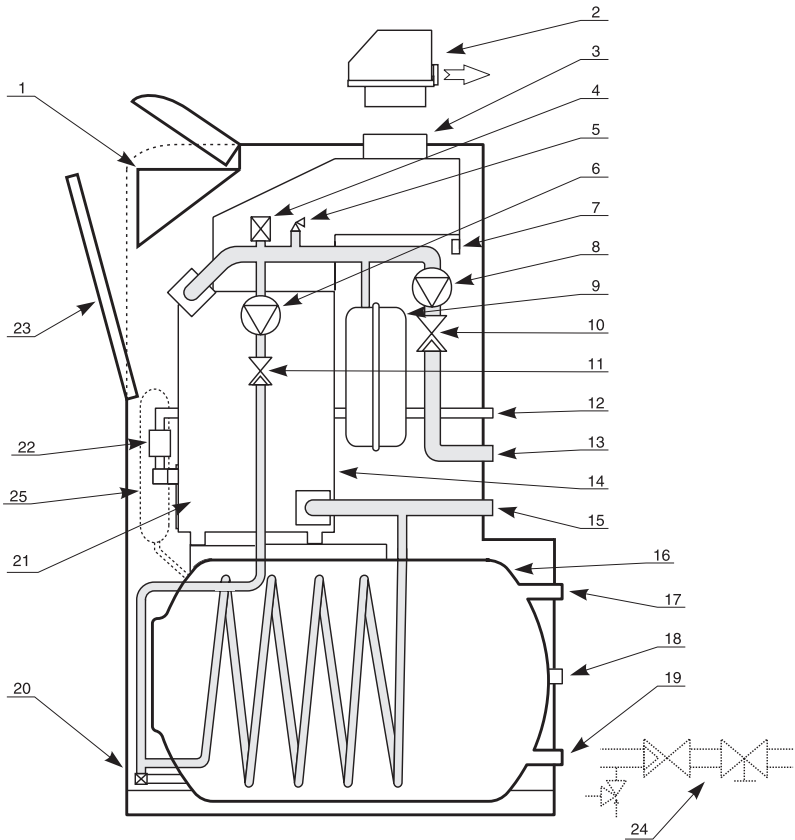

- | | | |
|-------------------------------------|------------------------------------|---------------------------------------|
| 1. Control panel | 10. Backflow valve for HeW circuit | 19. Hot water (cold water) inlet |
| 2. "POLO-TURBO" superstructure | 11. Backflow valve for HoW circuit | 20. Filling and discharge |
| 3. Combustion gas collector | 12. Gas inlet | 21. Burner plate |
| 4. Automatic bleeding valve | 13. Heating water outlet | 22. Gas valve with ignition automatic |
| 5. Safety valve | 14. Boiler body | 23. Hinged frontal cover |
| 6. Pump for HoW heating circuit | 15. Heating water inlet | 24. Set for installation on HoW inlet |
| 7. Combustion exhaust safety valve | 16. Hot water tank | 25. Expansion vessel for HoW circuit |
| 8. Pump for HeW circuit | 17. Hot water outlet | |
| 9. Expansion vessel for HeW circuit | 18. Connection of HoW circulation | |

Fig. 6

Installation instructions

Introduction

The PROTHERM Bear 20 (30, 40, 50) KLZ boiler is compatible with common types of hot water heating systems and heating radiators.

Important: The PROTHERM boilers must be put into operation only by authorised organisations according to Czech Bureau of Occupational Safety and Czech Safety Inspectorate Notice No. 21/1979 (in the wording of Public Notice No. 554/1990 Coll.).

The boiler must be put into operation and warranty and post-warranty service must be performed by the manufacturer's contracted service organisation, which meets the above specified requirements.

The boiler is designed to work in a normal AA5/AB5 environment according to STN 33 2000-3 and STN 33 2000-5-51 (i.e. within a temperature range of +5 to +40°C and humidity depending on temperature up to maximum 85%).

The 20 (30, 40, 50) KLZ boiler must not be installed in zones 0, 1 and 2, i.e. in rooms with a bath tub, in bathrooms, washing rooms and showers according to STN 33 2000-7-701 (Fig. 7).

The boilers are designed to run with heating water compliant with STN 07 7401 (above all this water must not under any circumstances be acidic, i.e. its pH factor must be greater than 7 and must have a minimal carbonate hardness).

The requirements for utility water properties are defined in STN 83 0616 (for drinking water STN 75 7111). If the water has a combined calcium and magnesium concentration greater than 1.8 mmol/l, it is useful to implement other "non-chemical" measures against incrustation (e.g. use of magnetic water treatment combined with a desludging device).

In the case of clogging of the system with dirt from the heating system or incrustation sediments or problems caused by other clogging (e.g. clogging of the heat exchanger, pump defects) are not covered by the boiler's warranty.

Upon installation and operation of the boiler it is prohibited in the sense of STN 92 0300 for objects (classified according to STN 73 0823) to be placed at a distance of less than:

- 100 mm in the case of materials which are not easily flammable, flammable with difficulty or medium flammable;
- 200 mm in the case of easily flammable materials (e.g. chipboard, polyurethane, polystyrene, polyethylene, sponge PVC, synthetic fibres, cellulose materials, asphalt strip, rubber and others).

Important: The surface temperature of the upper parts of the boiler (particularly the side walls and the cover) may exceed the ambient temperature by up to 50°C.

A minimum manipulation (free) space maintained around the immediate vicinity of the boiler must be sufficient for a person to work on it safely with bare hands and with common hand tools (we recommend a minimum distance of 300 mm on all sides and min. 600 mm in front of the boiler).

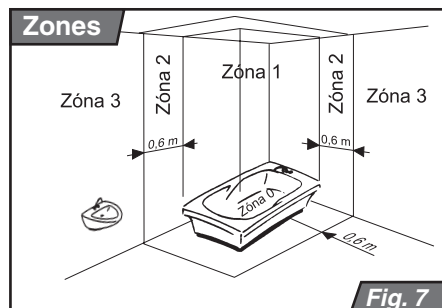

Fig. 7

The boiler is designed for combustion gases to be discharged (via a chimney inlet) with a minimum stabilised thrust of 2 Pa. The boiler is connected to the chimney inlet by a flue – for the boilers PROTHERM 20, 30 KLZ with Ø 130 mm, for the type PROTHERM 40 KLZ with Ø 150 mm and for the type PROTHERM 50 KLZ with Ø 180 mm.

Important: It is prohibited to place any objects restricting the combustion gas flow inside the flue (e.g. various types of heat exchangers to utilise their residual heat). The combustion gas exhaust flue is not part of the boiler accessories.

Construction of the combustion gas exhaust flue as well as that of the chimney must comply with the requirements of STN 06 1610 and STN 73 4210. Compliance with the principles specified by these norms will prevent undesirable phenomena from occurring, such as excessive cooling of the combustion gases, penetration of dampness into masonry and fluctuations in the chimney thrust, and thus prevent undesirable effects on the functioning of the boiler.

The boiler takes combustion air from the space in which it is installed. The minimum size of such a space requires that there is 0.8 cu.m of free space per 1 kW of boiler output, and in addition it must be possible to ventilate the space directly. If direct ventilation is not possible 2 cu.m of free space is required for each 1 kW of boiler output.

For discharge of combustion gases from PROTHERM 20, 30, 40, 50 KLZ boilers it is possible also to use the supplementary device “superstructure PROTHERM PT 20 (30, 40) POLO – TURBO”, which ensures the forced discharge of combustion gases. It enables the operation of cast iron boilers in cases where it is not possible to use regular discharge of combustion gases into a chimney. The superstructure is designed for direct connection to the combustion gas collector. The outlet of combustion gases from the superstructure

is adapted for connection of single-shell exhaust piping up to a length of 10 equivalent metres (1 equivalent metre = 1 metre of even section or 1 90° joint).

Mounting the superstructure onto the boiler and putting into operation may be performed only by an authorised organisation according to Public Notice of the Slovak Bureau of Occupational Safety no. 74/1996 Coll. It is essential to abide by the safety prescriptions during service interventions into the superstructure when this is connected to an electrical power source (even when the mains switch is off)!

The boiler is constructed for operation with heating water up to an overpressure of 400 kPa (4 bars), which complies with STN 07 7401 (this water must not under any circumstances be acidic, i.e. its pH factor must be > 7 and must have a minimal carbonate hardness).

With regard to their properties, which are unsuitable for operation of the boiler, use of antifreeze compounds is not recommended. This primarily concerns reduction of heat transmission, large scale expansion, ageing and damage to rubber elements. If no other possibility exists for reliably preventing freezing of the heating system within the specific conditions, failure to meet any of the functional parameters or any defects of the boiler as a consequence of use of antifreeze compounds cannot be covered by the boiler warranty.

The boiler may be used also in systems with an open expansion vessel. In such a case it is necessary to ensure an additional check upon installation and if applicable also adjustment of the factory setting of the emergency thermostat temperature – see point 3.4.

It is necessary to set the expansion vessel with regard to the system – in the sense of STN 06 0830 this ensures that the heating system itself is secured up to a total volume of 180 litres of water against quick pressure fluctuations and undesirable

stress on all its elements during operation. In cases where the total quantity of heating water in the closed system exceeds 180 l it is essential to include a second expansion vessel in the system. This vessel must have an identical same construction, i.e. it must be closed, with a membrane.

The resultant value of the water pressure in the system when cold is constantly indicated by the red (adjustable) hand of the boiler pressure gauge. If the pressure drops beneath such an indicated value it is necessary to seek and rectify any leakages or to de-aerate the system more effectively (or both). If pressure drops repeatedly and the entire system is effectively sealed and properly de-aerated, this most probably represents a fault in the expansion vessel, and it is essential to call an authorised technician to rectify this fault.

Upon filling of the hot water tank it is necessary to open the inflow and outflow from the tank and allow the water to flow out until it is entirely clear and without air bubbles.

Before final assembly of the boiler it is necessary to flush the distribution pipes of the heating system several times with pressurised water. In older, used systems this must be performed against the flow direction of the heating water.

Note: It is recommended to mount a sludge trap in front of the boiler (i.e. on the piping with return heating water). The construction of this trap should enable emptying at regular intervals without the necessity of discharging a large volume of heating water. The sludge trap may be combined with a filter, a filter with a sieve alone is not sufficient protection.

In the case of clogging of the boiler with dirt from the heating system, these problems or problems caused by other clogging are not covered by the boiler's warranty. The filter and sludge trap must be checked and cleaned regularly.

The requirements for utility water properties are defined in STN 83 0616 (for drinking water STN 75 7111). If the water

has a combined calcium and magnesium concentration greater than 1.8 mmol/l, it is useful to implement other "non-chemical" measures against incrustation (e.g. use of magnetic or electrostatic field).

The tank must not be exposed to the effects of:

- higher pressures than the maximum operational pressure;
- direct effects of fire or temperatures higher than ordinary working and climatic conditions
- impact, collision, force on the tank vessel, shakes and vibrations (with the exception of manifestations during actual operation – i.e. circulation of heating water and filling of utility water).

If the hot water issue points (cocks) are located very far from the boiler, it is possible to connect further piping, creating a circuit with constantly flowing hot water between the boiler and cocks (hot water circulation circuit). A hot water outlet is used for the piping from the boiler to the cocks, the return piping from the cocks to the boiler is connected to the "circulation" outlet. With the introduction of hot water circulation there is no discharge of cold water from the cock. The hot water supply is increased by the volume of the circulation piping – the length of heating may be perceptibly increased by this or at the same time also by inefficient insulation of the piping of the circulation circuit. The pump for hot water circulation is not controlled from the boiler and must meet the hygiene requirements.

If there are special requirements for relocation of the boiler (e.g. prevention of damage to covers, limited passage profile etc.) it is possible to partially disassemble the boiler from the assembled state in which it is delivered.

It is necessary to maintain a sufficient space around the boiler in order to ensure that handling of the boiler and its accompanying equipment during installation and operation can be performed safely.

Delivery completeness

Content of boiler delivery

PROTHERM Bear 20 (30, 40, 50) KLZ boilers are supplied completely assembled and functionally tested. Associated armatures (safety valve and backflow clack valve) are enclosed with the boiler for equipment for the hot water inlet, as well as a set of adjustable legs.

The delivery includes (Fig. 8):

1. The boiler
2. Operation and Installation Guide
3. Service Book
4. List of service centres
5. Warranty Certificate

Special delivery

On request the following selected accessories can be ordered:

1. Outdoor sensor for equithermal control, order no. 4180
2. Ventilator superstructure PROTHERM "POLO-TURBO" for thrust exhaust of combustion gases.
3. PROTHERM room control unit for regulation of boiler on the basis of temperature in referential room.

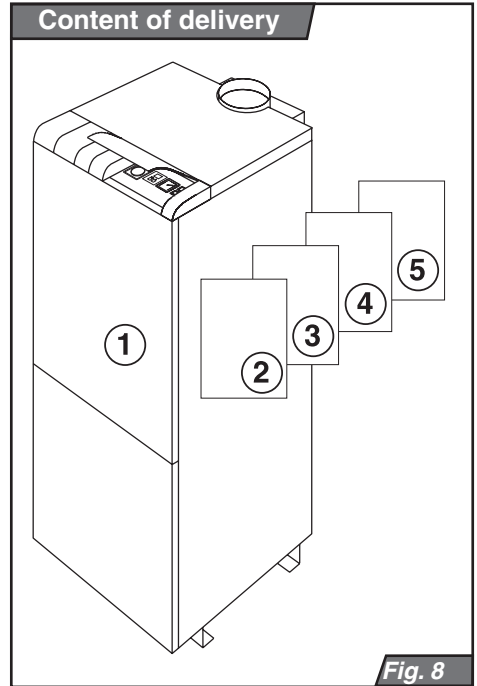

Fig. 8

Preparing for boiler installation

Boiler equipment

The boiler PROTHERM 20 (30, 40, 50) KLZ comprises the following parts:

- cast iron boiler body with thermal insulation.
- burner plate including gas path and starting equipment,
- combustion gas catcher with thrust breaker,
- hydraulic construction,
- boiler casing with control panel,
- hot water tank.

Cast iron boiler body

This is composed of elements and serves simultaneously as a combustion chamber (including combustion gas paths) and a water space (including water paths). The elements are lateral ("right" and "left") and central (of one type). The connection of the elements creates the boiler body with the relevant size (both of the combustion chamber and the water space). The assembled boiler body is connected to a hydraulic construction and insulated against heat loss and radiation. It is also fitted with clips for fitting the sensors of the thermostats and thermometer and clips on legs serving for connection with the boiler construction, in which the tank is placed.

Burner plate

This is fitted with a gas pipe section, its own burner pipes and a starting device. According to size (which corresponds to the size of the boiler body) it holds 2 to 4 burner pipes and the entire gas path. The gas path is formed by a pipe section of the gas connector, which ends with an inlet into the combined gas armature. The combined gas armature regulates gas inflow into the boiler depending on the required and attained operational states

of the system (i.e. of the boiler and heating system together); the outlet from this is the section of the gas piping of the burner plate finished with 2 to 4 jets (one on each burner pipe).

The burner is started by an electrical spark. An automatic control device is used to start and maintain running, which is connected directly with the combined gas armature manufactured by the same company to form a single unit, which also reduces all requirements for mutual interconnection.

Combustion gas catcher

This is a plate cover which contains the CDCS thermostat; it is connected directly to the thrust breaker and finished beyond this with the combustion gas collector of the boiler (for connection of exhaust flue). The CDCS – chimney draught control system – is based on monitoring the temperature of combustion gases on exhaust from the boiler; in the case of accumulation of these gases in the boiler (i.e. insufficient exhaust) it is activated and switches off the boiler (closes the gas inlet into the burner). The combustion gas catcher is fitted with a detachable cleaning jacket, which is accessible after removal of the upper part of the boiler casing (upper cover).

Hydraulic construction

This is a system of piping with a pair of pumps, backflow check valves and safety elements, i.e. with an expansion vessel for the hot water circuit (with nominal content of 10 l), a safety valve for the hot water circuit (with nominal opening pressure of 3 bar) and automatic de-aeration by valve. The hydraulic construction also includes end pieces for connection of the boiler.

Casing

This is composed of covers, firmly attached to the back wall and side plates, a detachable frontal wall and detachable upper part. The upper part contains a horizontal control panel, and a vertical control panel beneath the upper edge of the detachable frontal wall.

Hot water tank

This is a cylindrical vessel containing spiral piping. The heating water passes through the piping and heats the utility water in the vessel. The tank is enamelled inside and has a magnesium electrode for protection against corrosion. The external thermal casing of the tank is composed of polystyrene foam, with reflexive foil on the surface.

Hot water tank expansion vessel

The boiler is equipped with an expansion vessel for the hot water tank with a volume of 4 litres.

Placing of boiler

The boiler is fitted on a construction base, i.e. a platform (or pedestal). The platform must have at least a regular load capacity and must not be slippery. The surrounding area may be cleaned only in a dry manner (e.g. by vacuuming). If the platform is made of flammable material it is essential to furnish the boiler with a non-flammable, thermally insulating underlay which overlaps the ground dimensions of the boiler by at least 100 mm.

For passage of a boiler with case it is necessary to meet the condition that the doors have a width of at least 65 cm.

Adjustable legs

Before connection of the boiler to the heating system install the adjustable legs onto the boiler clamps for improved stability and balancing of the boiler. The instruction guide is included in the packaging.

Installing the boiler

In the case of service interventions into the boiler it is unconditionally necessary whenever the boiler is collected to the electrical power source (even when the mains switch of the boiler is off) to abide by the safety prescriptions for operation and work on electrical equipment (provision of norm STN 34 3100).

The boiler casing can be disassembled. The frontal section is secured by spring clamps in the upper corners of the casing. The frontal wall can be folded down by pulling on the upper corner, the upper side is folded from the back in an upwards direction after the removal of two screws. The remaining parts of the casing are attached with self-drilling screws to the boiler chassis. The individual parts of the casing are connected to the electrical installation of the boiler by protective conductors.

Exercise especial caution in transport handling of the boiler, with regard to the height of the centre of gravity.

The end pieces for connection are on the rear side of the boiler (see Fig. 5, Connection dimensions of boiler).

It is necessary to install a backflow clack valve and safety valve on the hot water inlet to the boiler. The clack valve combined in a single armature is supplied together with the boiler. The valve compensates for the volume expansion of the utility water during heating, and is thus constantly active, and it is recommended that water escaping from this is drained by a permanently installed drainage pipe into the waste water conduit. It is necessary for the water to have a smooth passage of drainage, without any possibility of accumulation of the drained water. In the case of a higher pressure of the inlet utility water than 600 kPa (6 bar) it is necessary to use a reduction valve before inlet into the boiler.

Before the combined armature (in the flow

direction of the utility water) it is desirable to install also a stopper, which is not included in the boiler delivery.

The combined armature is always installed – however water leakage from the safety valve in the armature may be resolved by installing an expansion tank for utility water. This concerns a “high pressure” (but not “heating”!) expansion vessel, which must have a nominal volume of at least 3 litres and nominal pressure of 600 kPa (6 bar). It must be placed behind the combined armature (in the flow direction of the water), either in front of or behind the vessel, in an appropriate place of the hot water distribution system.

Important: There must not be any stoppers or obstacles to the flow of water through the piping between the tank and the safety valve (combined armature) and between the tank and the expansion vessel for the utility water!

In order to ensure that no water leaks from the safety valve after installation of the “high pressure” vessel, the resulting working pressure of the vessel must be 10 to 30 kPa (0.1 to 0.3 bar) lower than the opening pressure of the valve!

The boiler pipe connection pieces (primarily for gas) must not be subjected to any forces from the pipe system of the heating system or gas inlet. This requires precise adherence to the dimensions of the end pieces of the connection pipes, vertically as well as in terms of the distance from the wall and the mutual distance between the individual inlets and outlets.

During reconstructions, in unfavourable building dispositions, etc., it is possible to connect the boiler to the heating system and gas mains by means of flexible elements (hoses), but only those which are designed for this purpose. Flexible components should be as short as possible, must be protected against mechanical and chemical loads and

damage, and must be replaced with new ones before the end of their useful life or before their reliability to meet their nominal parameters (as stated by their manufacturers) is diminished.

Properties of heating system and filling the heating system

It is necessary to set the temperature of the emergency thermostat according to the type of implementation of the heating system (open or closed). For open systems the emergency temperature is set to 95°C, for closed systems 105°C.

Setting of the heating water expansion vessel (pressure in its gas equalizing section) begins before filling – it is necessary to add extra pressure (e.g. by 50 kPa (0.5 bar) above the expected resulting water pressure in the system. This ensures that the equalizing volume is as large as possible and that this will be used as such in further operation. The system is then filled and preliminary pressured by cold water to the required pressure according to the pressure gauge on the boiler – in this manner the remaining (water) part of the expansion vessel is filled and filling is closed. In this state the overpressure is gradually relaxed from the equalizing part; the pressure in this is monitored by a pneumometer. Relaxing of the pressure continues as long as the equalizing part is “harder” than the water part (pressure on the pneumometer is higher than on the pressure gauge on the boiler).

Only when both monitored values become very close, very carefully continue relaxing the equalizing part so that the both values become equal and both begin to drop – this is the watershed where the sought largest equalizing volume is set for the given working point. In this phase of setting the expansion vessel changes in pressure are imperceptible and it is necessary to proceed very carefully, since the water is practically impossible to pressurise, and even in the case of reduction of the pressure effect its volume

will be practically unchanged. So when “throw” takes place during relaxation of the pressure from the equalizing gas part and the pressure watershed of the sought working point is exceeded and the water volume in the system is not changed, the gas part can be simply re-pressurised and pressure relaxation in seeking the pressure watershed can be repeated more carefully.

The tightness of the valve of the expansion vessel is not absolutely constant; if the pressure in the system drops this may be caused not only by a water leakage, but also by a reduction of the pressure effect of the equalizing gas part of the expansion vessel on the water part – upon topping up the system pressure by inlet of water the gas part may then “shrink” in volume, which reduces the overall expansion capability of the expansion vessel as against its nominal state. For this reason it is never possible to resolve setting of the expansion vessel only by simple pressurising of the equalizing gas part in operation with a longer duration with absolute certainty (or even in the shortest operation if water has been charged into the system)!!!

Setting of the hot water expansion vessel resides only in its pressurising before filling utility water into the boiler and distribution system to the resulting working pressure.

After filling the heating system, de-aeration and setting the pressure expansion vessel (if this is used), the resulting pressure of the heating water in the system when cold is indicated by the (red) adjustable hand of the boiler pressure gauge.

Operating the boiler

Preparing and starting the boiler

Check the water pressure on the boiler pressure gauge. By opening the gas cock gas is inlet into the boiler. Connect the plug of the flexible power cord into the socket and press the mains button. The heating and hot water are set to approx. $\frac{1}{2}$ of their volume. In the first additional "mode" we select automatic setting of the heating water temperature for running of the pump, for subsequent actual operation this is adjusted further as applicable. The boiler ignites and heats the hot water. After this heating the boiler heats in the heating system.

During the running of the boiler check the gas tightness of all connections of the gas path in the boiler, e.g. using a foam-

forming solution. It is necessary to rectify any determined leakages and repeat the check.

At the end of preparing and starting the boiler check and if necessary adjust the output of the boiler with regard to the heating system by setting the gas pressure on the outlet of the gas armature and set this according to the requirements of the customer.

Setting gas pressure

Output is set using the regulating elements on the combined gas armature (see illustration of gas armature), pressure is measured using the U-manometer (against atmosphere).

Regulating gas armature

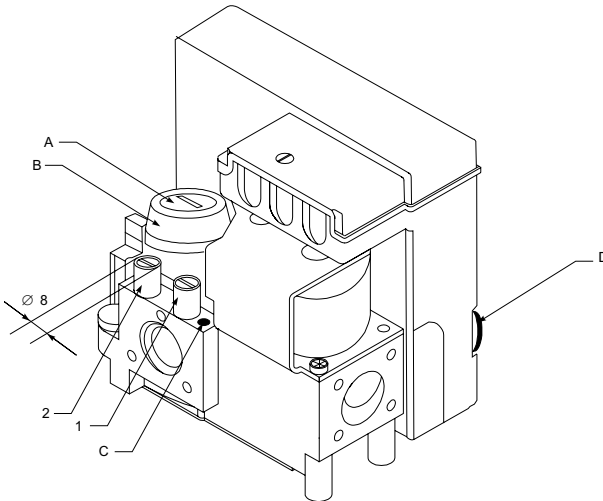

- 1 – measurement point of gas pressure on inflow to armature
- 2 – measurement point of gas pressure on outflow from armature
- A – cover plug
- B – setting (internal) screw of maximum
- C – setting screw of minimum
- D – electrical setting of minimum

Fig. 9

Before commencing setting, when the boiler is switched off (plug of electrical power cord is removed from socket), it is necessary to:

- detach the covering (metal) plug (A)
- relax the closing screw of the measurement point (2) of outflow gas pressure and slide on the tube of the U-manometer (screw not removed)

Maximum output

- The boiler is put into operation and left to work during hot water consumption at maximum output. The course of measurement should not be interrupted by switching off the boiler e.g. by reaching the maximum hot water temperature or heating water temperature etc.;
- By turning the plastic screw (B) the gas pressure is set to maximum output – by turning it clockwise gas pressure is increased:
 - 125 mm of water column for natural gas
 - 270 mm of water column for propane

Reduced output

Measurement is performed upon soft start after the boiler is switched on in heating mode (this state persists for max. 100 seconds)

- using the screw (C) the left limit position is set to minimum output (anticlockwise)
- the dial (D) on the automatic device is used to set:
 - 55 mm of water column for natural gas
 - 130 mm of water column for propane

After completing setting switch the boiler off, remove the U-manometer tube and slightly tighten the closing screw at the measurement point. Screw the metal cover plug back on. Put the boiler into operation and perform a tightness test of the measurement points on the gas armature.

First heating

The first heating is a short, sharp operation of the boiler after its initial connection to the heating system.

Set the boiler control elements (operational controls, room control unit) so as to attain the highest possible heating water temperature in the system and at the same time the smallest possible number of shutdowns of the boiler. Maintain the entire system (boiler and heating system) in these conditions until it is stabilised (i.e. the temperature becomes constant also on the body at the furthest distance from the boiler), and for at least one hour more.

The boiler is shut down. Record the pressure value (on the boiler). Once more carefully de-aerate the system and subsequently pressurise to the recorded value.

Finally the system is allowed to cool. During the drop in temperature check that there is not also simultaneously a marked pressure drop. In the case of such a pressure drop check for leakages, rectify them and repeat the first heating.

Service (additional) modes

Setting attenuation in heating

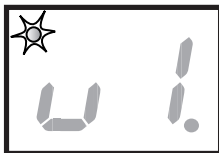

The parameter “u” appears on the display and the diode flashes in the upper left-hand corner. This parameter is used to set the attenuation in

the heating system, which depends on the timer switch. In this setting the attenuation interval is identical to the attenuation interval for heating the hot water tank up to the required temperature, i.e. during this interval the set heating water value drops by the value of this parameter. The required parameter is selected using the  button and subsequently confirmed with the MODE button, which at the same time transfers the boiler into the next mode.

Values of “u” parameter:

- u1 – no attenuation
- u2 – attenuation by 3°C
- u3 – attenuation by 6°C
- u4 – attenuation by 9°C
- u5 – attenuation by 12°C
- u6 – attenuation by 15°C
- u7 – attenuation by 18°C
- u8 – attenuation by 21°C
- u9 – attenuation by 24°C
- u- - max. attenuation (boiler shut down according to setting of timer switch)

Running pump

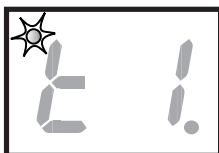

The parameter “t” appears on the display and the diode flashes in the upper left-hand corner. In this mode the “t” parameter is set to

the heating water temperature at which the heating water pump is started, i.e. the pump is switched on when the temperature set using the “t” parameter is reached. The required parameter is selected using the

 button and subsequently confirmed with the MODE button, which at the same time transfers the boiler into the next mode.

Values of “t” parameter:

- t1 = 40°C
- t2 = 45°C
- t3 = 48°C
- t4 = 50°C
- t5 = 52°C
- t6 = 54°C
- t7 = 56°C
- t8 = 58°C
- t9 = 60°C

t- - automatic setting of heating water temperature according to current required temperature.

Starting output of boiler

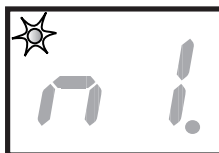

The parameter “n” appears on the display and the diode flashes in the upper left-hand corner. In this mode the starting output of the boiler is

set as follows: “n -” – maximum starting output. The required parameter is selected using the  button and subsequently confirmed with the MODE button, which at the same time transfers the boiler into the next mode.

Electrical connection of boiler

The boiler is connected to power supply by a three-core flexible cord with a plug. A fixed socket through which the boiler is connected to power mains must comply with the provisions of STN 33 2000-4-46. This must always have a protective (earth) contact (pin), reliably connected by a PE or PEN wire (yellow-and-green). The boiler must be always connected to the protection wire (earth) through its power cord and must be always installed in such a manner that the socket and plug are accessible. Use of adapters, extension cords etc., is not permitted.

Important: Preparation of the socket and connection of the room control unit, which requires intervention with the boiler's internal wiring, must be always connected by a qualified electrician in accordance with Public Notice No. 50/1978. Likewise servicing of the electro-technical part must be performed by only a person with the above qualification. Before performing any works on the electro-technical part, the boiler must be disconnected from the power supply by removing the power cord plug from the power socket!

The main part of the boiler is secured by a tube fuse (T1, 6A / 250 V), which is located on the control panel of the boiler.

For control of the boiler using a room control room unit only a zero-potential output room control unit may be used, i.e. a unit which convey no foreign voltage to the boiler.

The room control unit must be connected to the boiler by a two-core cable. The recommended copper wire cross-section is 0.5 to 1.5 sq.mm.

The room control unit connection cables must not run concurrently with power wires or cables.

The terminal for connection of the room control units is equipped from the factory with a jumper and is located in the electrical box of the boiler. Before connection of the room regulator it is necessary to remove the jumper on the terminal. In all other cases the jumper is left.

If the boiler is to be operated in the continuous control mode according to outside temperature, i.e. equithermal regulation, an outdoor temperature sensor is attached to it.

This sensor is located outside, preferably at half the height of the building (or of the heated zone), at least 2.5 m above the ground. If equithermal regulation is predominantly intended to control heating according to the required comfortable temperature, the sensor is placed on the same side of the building as the windows of the heated rooms – if this cannot be secured then it is placed on the north-western side. If equithermal regulation is predominantly intended to optimise the quantity of heat, the sensor is always placed on the coldest (most often north) side of the building.

The sensor is connected to the boiler by a two-core cable with a cross-section of (copper) conductors of at least 0.5 sq.mm and a length of maximum 30 m (between boiler and sensor, i.e. total 60 m of conductor measured from boiler to sensor and back to boiler). This cable must not run concurrently with other electrical wiring and areas with more powerful electrical machinery (e.g. welding machines).

Diagram of connection of external elements

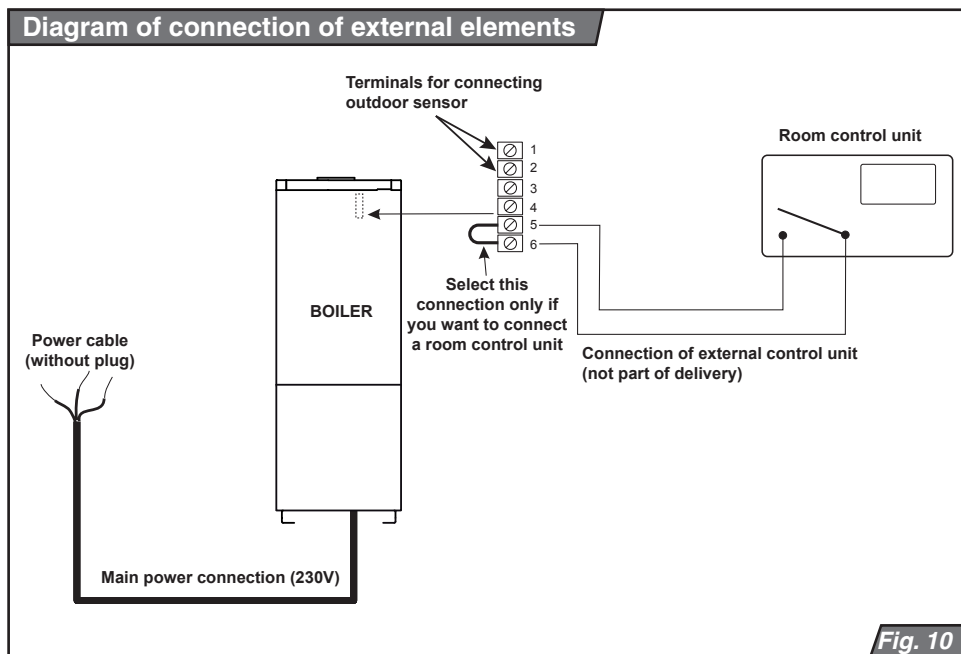

Fig. 10

Converting to different fuel

If it is necessary to convert to a different type of fuel (natural gas to propane and vice versa), the boiler is reconstructed in the following manner. This reconstruction may be performed exclusively by a service authorised by the manufacturer.

The following are performed:

1. Disassembly of burner from boiler;
2. Replacement of all burner jets with others (according to type of fuel).
3. Replacement of burner tubes with others (according to type of fuel).
4. Upon change from natural gas to propane the cooling rods including clamps are mounted on the burner tubes – three rods on each tube. The rod in the axis of the combined ignition electrode is shortened by approx. 35 mm. Upon change from propane to natural gas, the

cooling rods must be removed.

5. Re-mounting of burner.
6. Setting of prescribed gas pressure to designated boiler output (see chapter "Preparing and starting the boiler"). Together with setting the prescribed gas pressure for the designated boiler output the following are performed:
 - upon change from natural gas to propane setting of "SOFT-LITE" to MAX (fastest opening of gas valve);
 - upon change from propane to natural gas setting of "SOFT-LITE" to MIN (slowest opening of gas valve).

"SOFT-LITE" is located on the foot of the body, on the side of gas outlet from the valve. It has a dark plastic plug with bayonet hook (turning and removal of plug must be performed without use of force

– otherwise this could cause damage (tearing) of “SOFT-LITE”). The red rotating knob underneath the plug has an arrow, which:

- if turned in the direction of gas flow is at the value MAX;
- if turned against the direction of gas flow is at the value MIN.

7. Checking of the tightness of connections of the gas path and subsequent safety measures:

- the type of fuel for which the boiler is now designated is indicated on the boiler in an appropriate manner
- change, date and person performing change are recorded in the accompanying technical documentation of the boiler.

Important: In the case of reconstruction

only original parts supplied by the manufacturer or person authorised by the manufacturer are used. Reconstruction may be performed only by a qualified technician! In changing the type of fuel it is essential to respect the requirements for construction of the screw connections on the gas piping inside the boiler, i.e. to seal them with material appropriate for assembly and corresponding effects of the given type of fuel:

- for natural gas e.g. plumbing hemp infused with varnish, linseed oil etc.;
- for propane-butane e.g. plumbing hemp infused with spirit cements produced either from lamp black (type HERMETIC) or shellac with an admixture of washed graphite.

The setting of all elements is secured (e.g. by a drop of paint).

Electrical diagram of boiler PROTHERM 20 (30, 40, 50) KLZ

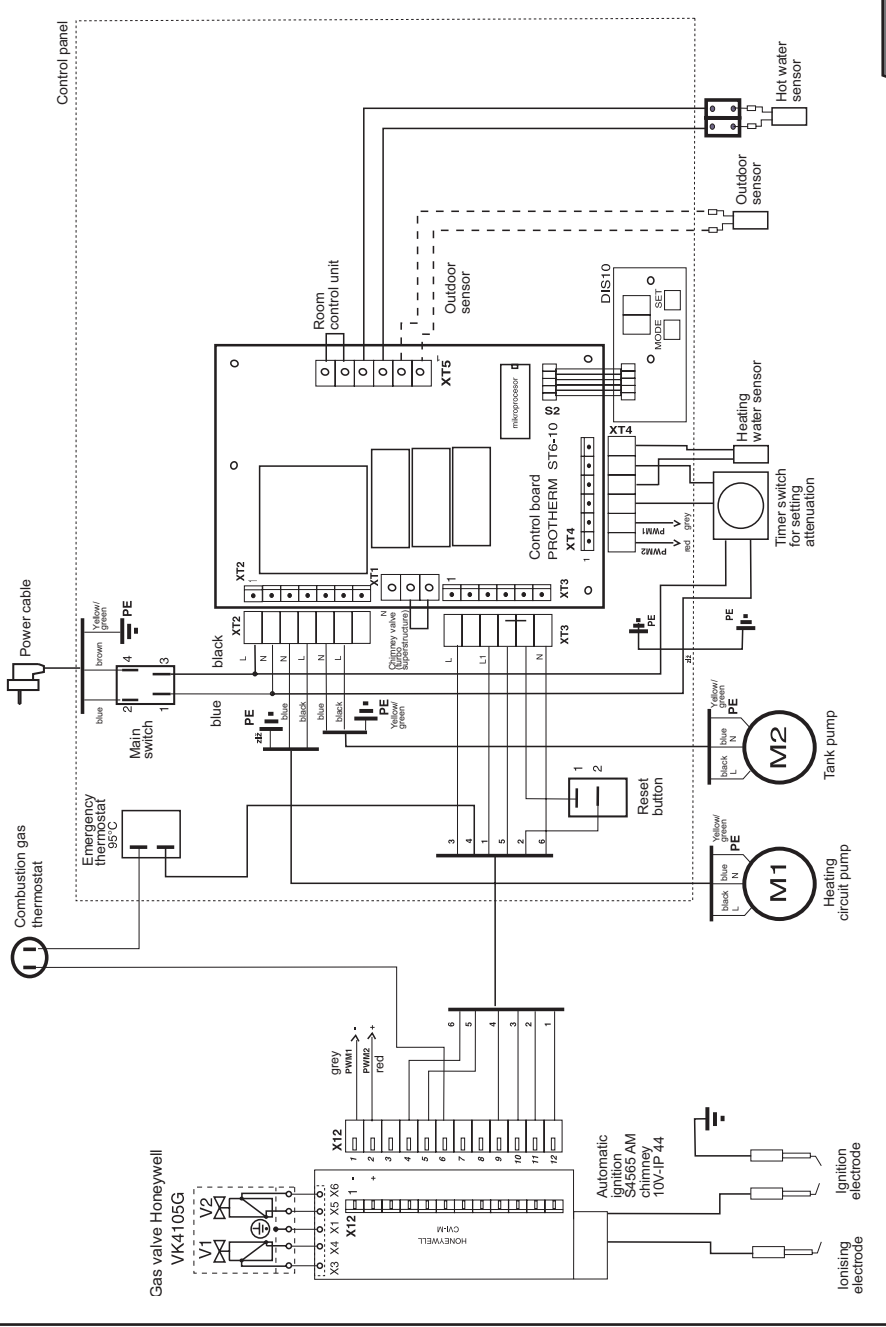

Fig. 11

protherm 



Bear

Operation and Installation Guide

20, 30, 40, 50 KLZ

- Stationary cast iron boiler
- Output range 17 – 44.5 kW
- Continuous output modulation
- Integrated 110 l hot water tank

www.protherm.eu

Protherm spol. s r.o.
Pplk. Pljuša 45
909 01 Skalica, Slovakia
Tel.: +421 34 6966 101
Fax: +421 34 6966 111

Your service organisation:

EN **CE**
version

xxxx_01 - v.3 2/2007