



# **The Powrmaster TE Range**

## **Installation and Servicing Instructions**

**WARNING: THIS APPLIANCE MUST BE EARTHED**

£2.50 When supplied separately.

TE Range Issue 4 February 2006

# CONTENTS

<i>Section</i>	<i>Title</i>	<i>Page</i>
<b>1.</b>	<b>Introduction</b>	<b>2</b>
<b>2.</b>	<b>Technical Data</b>	<b>3</b>
<b>3.</b>	<b>General Requirements</b>	<b>4</b>
<b>4.</b>	<b>Installation</b>	<b>5</b>
<b>5.</b>	<b>Control Thermostat Siting</b>	<b>5</b>
<b>6.</b>	<b>Commissioning &amp; Testing</b>	<b>5</b>
<b>7.</b>	<b>Servicing</b>	<b>7</b>
<b>8.</b>	<b>Fault Finding</b>	<b>IBC</b>
<b>9.</b>	<b>Short List of Parts</b>	<b>IBC</b>
<i>Tables</i>	<i>Title</i>	<i>Page</i>
<b>1.</b>	<b>Dimensions (S.I. Units)</b>	<b>3</b>
<i>Figure</i>	<i>Title</i>	<i>Page</i>
<b>1.</b>	<b>Belt Tension Adjustment</b>	<b>7</b>
<b>2.</b>	<b>White Rodgers 5F464</b>	<b>7</b>
<i>Appendix</i>	<i>Title</i>	<i>Page</i>
<b>A</b>	<b>Calculation of Flue System Equivalent Resistance</b>	<b>9</b>

## **1. INTRODUCTION**

The Powrmatic TE range of gas fired forced draught, closed flue, fanned circulation air heaters cover a heat output range of 88 kW (300,000 Btu/h) to 806 kW (2,750,000 Btu/h) and are intended primarily for heating commercial or industrial premises. They are certified for use on Natural Gas, Group H - G20.

The heaters are for floor mounting, freeblowing applications only.

TE heaters have a double axial fan assembly fitted upstream of the combustion chamber / heat exchanger assembly to circulate the air being heated. Heaters are fitted as standard with fully automatic monoblock On/Off forced draught gas burners and monoblock gas control assemblies. High/Low or modulating burners are available as options.

Each air heater must be connected to a closed flue system only.

### **Gas Safety (Installation & Use) Regulations**

It is law that all gas appliances are installed, adjusted and, if necessary, converted by qualified persons\* in accordance with the current issue of the above regulations. Failure to install appliances correctly can lead to prosecution. It is in your own interests and that of safety to ensure that the law is complied with.

\* e.g. Corgi Registered

## 2 Technical Data

### 2.1 Dimensions

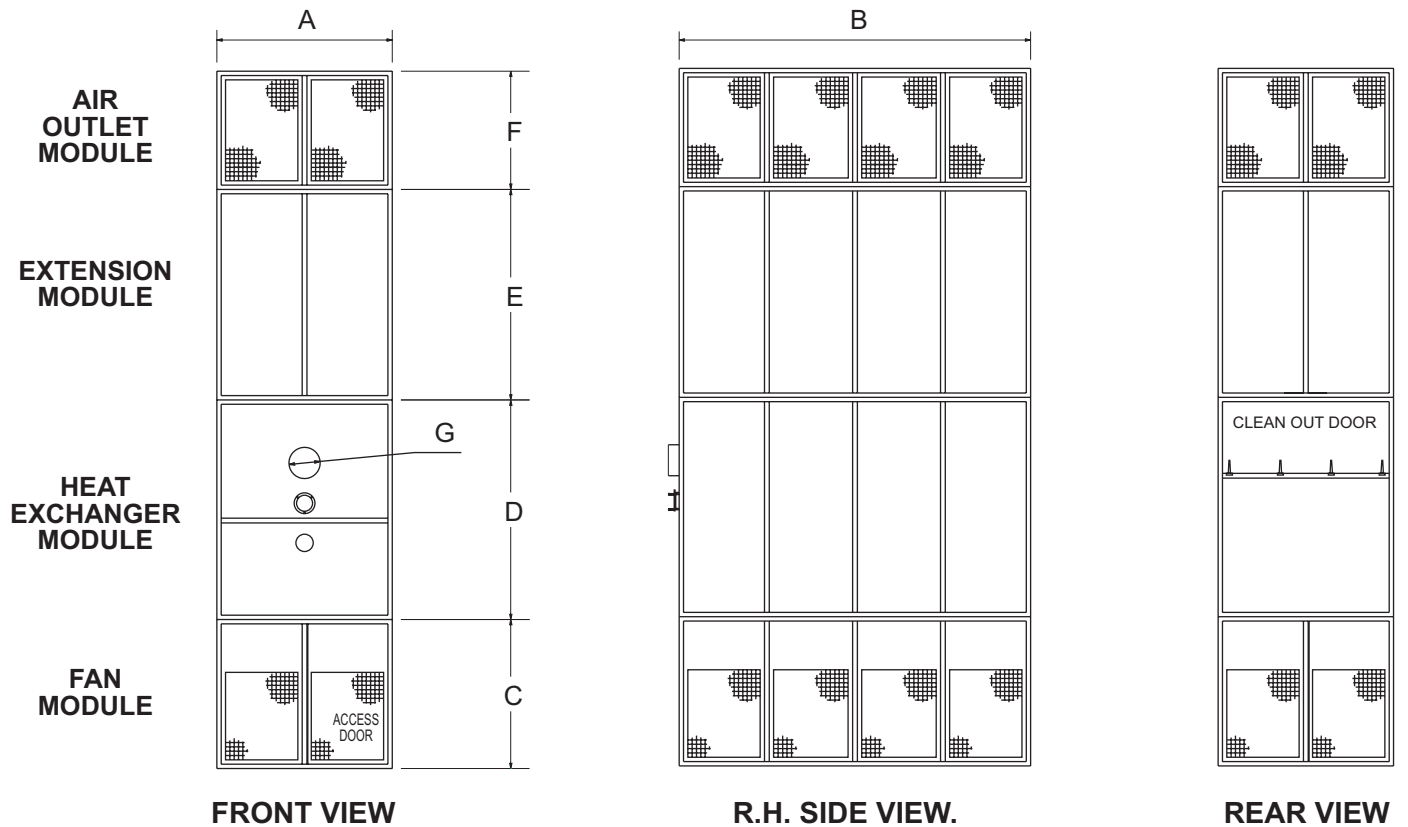

Note: TE 21 Fans and Combustion chamber/Heat exchanger are in one section

**Table 1. Dimensions (S.I. Units)**

Model		A	B	C	D	E	F	G
TE21	mm	1010	1568	1873 in Total		1873	1416	150
TE31	mm	1162	2025	1213	1574	1778	660	200
TE41	mm	1518	2991	1213	1975	1899	959	300/350
TE61	mm	2026	4058	1721	2534	2432	1365	

### Specifications, Burner Pressures and Electrical Data.

TE heaters are designed to suit individual applications. Please refer to the enclosed specification sheet for the data specific to the heater supplied.

### 3. General Requirements

#### 3.1 Related Documents

The installation of the air heater(s) must be in accordance with the rules in force and the relevant requirements of the Gas Safety Regulations, Building Regulations and the I.E.E. Regulations for Electrical Installations. It should be in accordance also with any relevant requirements of the local gas region, local authority and fire authority and the relevant recommendations of the following documents.

#### British Gas Plc Publications

IM/11 : 1989 Flues for Commercial and Industrial Gas Fired Boilers and Air Heaters

IM/16 : 1988 Guidance notes for the installation of gas pipework, boosters and compressors in Customer's premises (excluding domestic installation of 25mm and below).

#### British Standards Code of Practice

BS 6230: 1991 Installation of Gas Fired Forced Convection Air Heaters for Commercial and Industrial Space Heating.

#### 3.2 Location

The location chosen for the air heater must permit the provision of a satisfactory flue system and an adequate air supply. The location must also provide adequate space for servicing and air circulation around the air heater. The heater(s) must not be installed in conditions for which it is not specifically designed e.g. where the atmosphere is corrosive or salty and where high wind speeds may affect burner operation, and they are not suitable for outdoor use.

Where the location of the air heater is such that it might suffer external mechanical damage e.g. from overhead cranes, fork lift trucks, it must be suitably protected. TE units are designed to operate in a maximum ambient temperature of 25 °C.

#### 3.3 Gas Supply

##### 3.3.1 Service Pipes

The local gas undertaking should be consulted at the installation planning stage in order to establish the availability of an adequate supply of gas. An existing service pipe must not be used without prior consultation with the local gas undertaking.

##### 3.3.2 Meters

A gas meter is connected to the service pipe by the local gas undertaking or a local gas undertaking contractor. An existing meter should be checked, preferably by the gas undertaking, to ensure that the meter is adequate to deal with the total rate of gas supply required.

##### 3.3.3. Installation Pipes

Installation pipes should be fitted in accordance with IM/16:1988. Pipework from the meter to the air heater must be of adequate size. Do not use pipes of a smaller size than the inlet gas connection of the heater. The complete installation must be tested for soundness as described in the above Code. The complete installation must be tested for soundness as described in BS 6230.

##### 3.3.4. Boosted Supplies

Where it is necessary to employ a gas pressure booster the controls must include a low pressure cut off switch at the booster inlet. The local gas undertaking must be consulted before a gas pressure booster is fitted.

#### 3.4 Flue System

Detailed recommendations for fluing are given in BS 5440, Part 1 (Flues) and IM/11.

The air heater must be connected to a closed flue system. The cross sectional area of the flue serving the appliance must be not less than the area of the flue outlet to the air heater.

Materials used for the flue system should be mechanically robust, resistant to internal and external corrosion, noncombustible and durable under the conditions to which they are likely to be subjected.

Prevention of condensation within the flue should be an important factor in the design of the flue system. In order to minimise condensation the use of double walled flue pipe or insulation is recommended. If double walled flue pipe is used it should be of an acceptable type. Where condensation in the flue is unavoidable provision should be made for condensation to flow freely to a point at which it can be released, preferably into a gully. The condensation pipe from the flue to the disposal point should be of non-corrodible material of not less than 22mm (1/2") size.

Facilities should be made for disconnecting the flue pipe(s) from the air heater(s) for inspection and servicing purposes. The flue should terminate in a freely exposed position and must be so situated as to prevent the products of combustion entering any opening in a building in such concentration as to be prejudicial to health or a nuisance. An approved terminal must be fitted at the flue outlet.

#### 3.5 Air Supply

In buildings having a design air change rate of less than 0.5 /h, and where TE heaters are to be installed in heated spaces having a volume less than 4.7 m<sup>3</sup> /kW of total rated heat input grilles shall be provide at low level as follows:-

The total minimum free area shall not be less than 270cm<sup>2</sup> plus 2.25 cm<sup>2</sup> per kilowatt in excess of 60 kW rated heat input.

The air vent(s) should have negligible resistance and must not be sited in any position where it is likely to be easily blocked or flooded or in any position adjacent to an extraction system which is carrying flammable vapour.

#### 3.6 Air Distribution System

Care should be taken to avoid impeding the air throw with racking, partitions, plant or machinery etc.

A full and unobstructed return air path to the air heater(s) must be provided.

Care must be taken to ensure that return-air intakes are kept clear of sources of smells and fumes, and in special circumstances where there is any possibility of pollution of the air by dust, shavings etc., precautions must be taken by carefully positioning return air intakes and by the provision of screens to prevent contamination.

#### 3.7 Electrical Supply

Wiring external to the air heater must be installed in accordance with the I.E.E. Regulations for Electrical Installations and any local regulations which apply. Wiring should be completed in flexible conduit.

TE heaters require a 400V - 3N, 50Hz supply. The method of connection to the main electricity supply must facilitate the complete electrical isolation of the air heater(s) and the supply should serve only the air heater(s). The isolator must have a contact separation of at least 3mm in all poles. The method of connection should be provided adjacent to the air heater(s) in a readily accessible position.

See the accompanying wiring diagram for the heater electrical connections.

## 4. Installation of Air Heater(s)

### 4.1 General

**Before installation, check that the local distribution conditions, nature of gas and pressure, and adjustment of the appliance are compatible.**

The air heater must be installed in accordance with the rules in force and the relevant requirements of any fire regulations or insurance company's requirements appertaining to the area in which the heater is located, particularly where special risks are involved such as areas where petrol vehicles are housed, where cellulose spraying is carried out, in wood working departments etc. Whichever method of mounting the air heater is used the following minimum clearances for installation and servicing must be observed.

To the front	1.0m
To the rear	The depth of the heater
To the side	1.0m
Above the heater	1.0m

Any combustible material adjacent to the air heater and the flue system must be so placed or shielded as to ensure that its temperature does not exceed 65 °C.

#### **IMPORTANT:**

1.No air heater shall be installed where there is a foreseeable risk of flammable particles, gases vapours or corrosion inducing gases or vapours being drawn into either the heated air stream or the air for combustion. In such cases installation may only proceed if the air to be heated and the air for combustion are ducted to the heater from an uncontaminated source preferably outside the building. In certain situations where only airborne particles are present it may suffice to fit filters on the air inlet ducts of the heater. Advice in these instances may be obtained from Powrmatic Ltd.

### 4.2 Installation

TE heater installation may only be completed by Powrmatic Ltd or their appointed representatives. The heaters must be installed on a level noncombustible floor capable of supporting the weight of the heater.

### 4.3 Flue System

A Tee piece is supplied with each heater and must be fitted to the flue outlet socket on the heater. The flue system then connects directly on to the tee. *For flue sizes refer to Data Sheet.* All units must be fitted with a flue having a minimum height, from the heater to the flue terminal, of 2m. Horizontal runs of flue are not permitted unless they are adequately compensated by associated vertical sections.

If necessary a single offset using two 45° bends can be included to avoid obstructions. The maximum equivalent resistance of the flue system must not exceed 30pa. Details of how to calculate the resistance of the flue to be installed are given in Appendix A.

### 4.4 Condensate Drainage

The design of the flue system should minimise the formation of condensation, however when this is envisaged to be a problem provision should be made for condensation to flow to a joint where it can be drained, preferably into a gully.

### 4.5 Gas Connection

A servicing valve and downstream union must be fitted at the inlet to the air heater gas controls assembly to facilitate servicing. The gas supply to the air heater must be completed in solid pipework and be adequately supported.

#### **Warning**

When completing the final gas connection to the heater do not place undue strain on the gas pipework of the

heater.

## 4.6 Electrical Connections

All units are fully pre-wired and only require final connections for the incoming mains supply and, if required by the specification, completion of any external control circuits e.g. via a room thermostat, time clock etc. The electrical supply must be run to a point adjacent to the heater and be suitably terminated to provide an isolation point that will prevent remote activation of the unit during servicing. The heater electrical panel is located at the front of the heater and cable entry points are provided in the adjacent heater framework. Reference must be made to the enclosed data sheet to ascertain the electrical loading of the air heater(s) being installed so that cables of adequate cross-sectional area to safely carry that load are used for the electrical installation. The length of the conductors between the cord anchorage and the terminals must be such that the current carrying conductors become taut before the earth conductor if the cable or cord slips out of the cord anchorage. All external controls must be of an approved type.

*See the wiring diagram accompanying these instructions.*

## 5. Control Thermostat Siting

If the specification requires a remotely mounted control thermostat it should be fitted at a point which will be generally representative of the heated area as far as temperature is concerned. Draughty areas, areas subjected to direct heat e.g. from the sun, and areas where the air movement is relatively stagnant e.g. in recesses, are all positions to be avoided for siting the thermostat. The thermostat should be mounted about 1.5m (5ft) from the floor.

Any thermostat, time clock etc. must be suitable for switching 230V, 5A and must be of the 'snap action' type to minimise contact bounce.

*For electrical connections of external controls see the wiring diagram accompanying these instructions.*

## 6. Commissioning & Testing

**Note:** TE41 &TE61 - Turn key for electrical panel access door locks may be used to operate door electrical interlock for commissioning purposes .

### 6.1 Electrical Installation

Checks to ensure electrical safety must be carried out by a qualified person.

### 6.2 Gas Installation

The whole of the gas installation, including the meter, should be inspected and tested for soundness and purged in accordance with the recommendations of IM/16:1988.

### 6.3 Fan Rotation

1. Open main electrical panel and switch Eurotrol 2 control (see Eurotrol 2 manual supplied) in main electrical panel to **Fan Only** and the time clock to 'ON'.

1. Close main electrical panel and with door isolator switch 'ON' turn the AUTO-OFF-MAN switch to 'ON' to start main air fans. Ensure that the fan direction of rotation corresponds with the direction of rotation arrow on the fan shroud. If necessary reverse the direction of rotation by interchanging any two of the 3ph main supply leads at the terminal strip in the electrical panel.

2.Reset the Eurotrol 2 to **Heating**

### 6.4 Lighting the Air Heater

#### 6.4.1 Gas Controls Assembly - Soundness Check

1. Ensure the gas service valve at the inlet to the gas controls assembly is shut.

2. To prove soundness of the first main safety shut-off

valve and first start gas safety shut-off valve:-

- a) Connect pressure gauge to the inlet pressure test point on the main valve block or inlet pipework.
- b) Open gas service valve and allow pressure to stabilise before shutting it again. The valves are sound if no pressure drop is observed. If a pressure drop is observed do not proceed until the fault has been rectified. Remove pressure gauge and refit sealing screw in pressure test point.

### 6.4.2 Sequence Check

1. Refer to the burner instructions supplied with the heater.

### 6.4.3 Final Adjustment

1. Remove the sealing screw from the pressure test point located on the side of the gas inlet to the burner head and attach a pressure gauge. Remove the sample point cover plug from the outlet flue length and insert a CO<sub>2</sub> measuring instrument.
2. Remove the link in the main electrical control panel to isolate the main gas valves.
3. Turn "ON" the main electricity supply and check that the following sequence of events occur.
  - i) Burner fan runs.
  - ii) Ignition spark is heard.
  - iii) Start gas valves open.
  - iv) Start gas flame is established.
4. Check that the start gas pressure agrees with that in Tables 3.1 or 3.2. If necessary adjust the start gas pressure (See Data Sheet).
4. Turn "OFF" the main electricity supply.
5. Reconnect the main gas valves electrical link.
6. Turn "ON" the main electrical supply and the burner will run through its sequence until main flame is established. Check that the main burner gas pressure agrees with that on the specification sheet. If necessary adjust the main burner gas pressure (See Data Sheet and also Burner Manual for method).
7. Measure the CO<sub>2</sub> content of the flue gases. If it is necessary to adjust the combustion air ratio controls, to obtain a reading of 9.0 - 9.5%, refer to the Burner Manual.
8. Remove pressure gauge, refit sealing screw in pressure test point and flue sample point cover plug.

### 6.4.4 Final Soundness Test

1. After making final gas rate checks all joints on the gas controls assembly must be tested for soundness using leak detection fluid.

## 6.5 Controls

The general layout of the control panel is as shown opposite.

### 6.5.1 Proportional Controller

1. Press SET and LD1 lights
2. Press ▲ or ▼ to adjust to the desired set point
3. Press SET and LD2 lights
4. Press ▲ or ▼ to adjust to the desired proportional band.
5. Display reverts back to temperature display after 15 secs

Example:

20° set point 3° proportional band

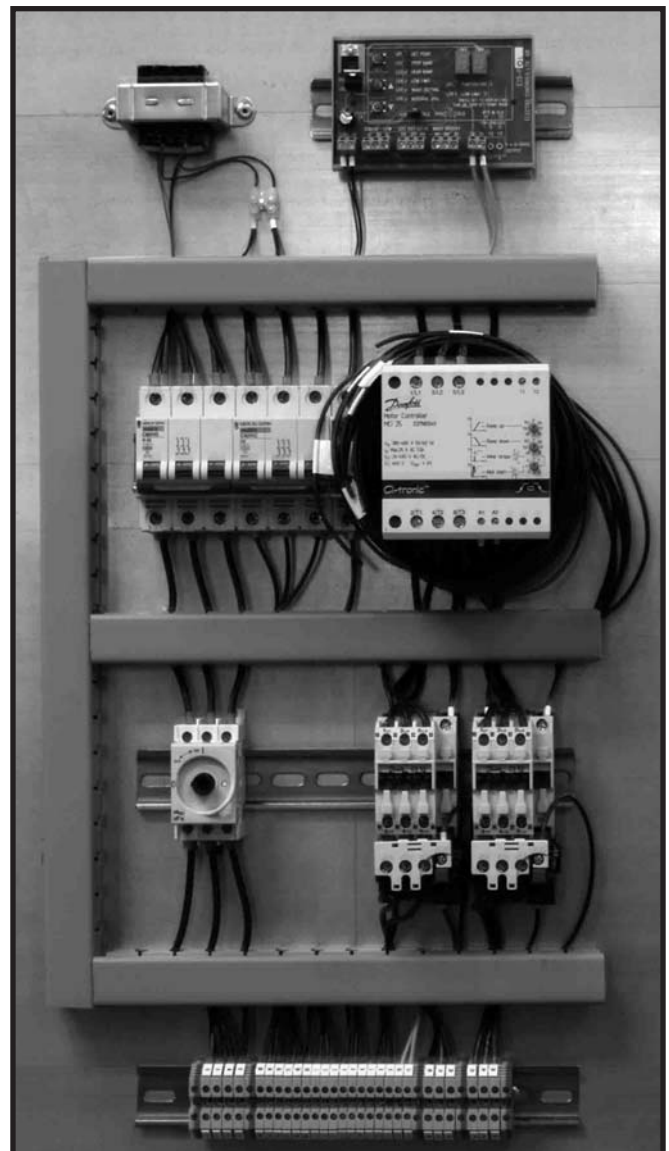
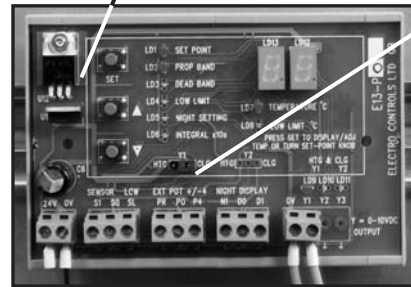
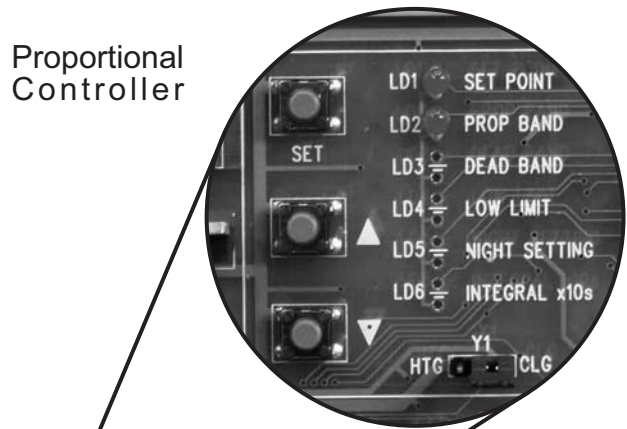

Main Control Panel

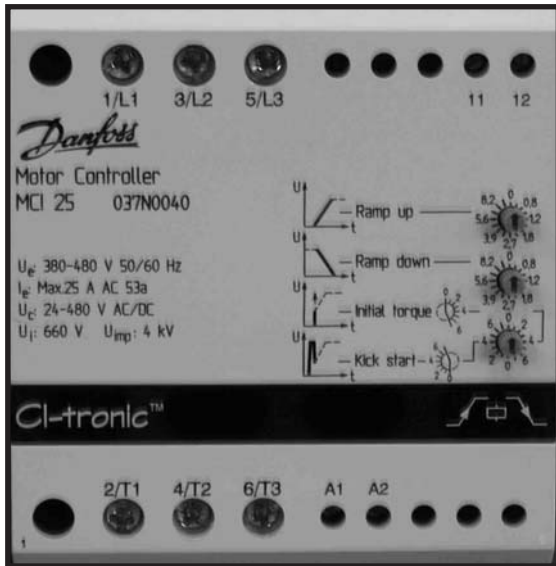

MCI 25 Motor Controller

### 6.5.2 MCI 25 Motor Controller

This will have been set prior to the heater being despatched and the settings as seen should be retained. Default values are as follows:-

1. Ramp Up - 8.2
2. Ramp Down - 8.2
3. Torque - 1.0
4. Kick Start - 0.0

### 6.5.3 Eurotrol 2

See the Eurotrol 2 instructions separately supplied.

### 6.6 Hand Over

Hand the Users Instructions to the user or purchaser for retention and instruct in the efficient and safe operation of the air heater and associated controls.

Adjust the automatic controls to those values required by the User.

Finally, advise the user or purchaser that, for continued efficient and safe operation of the air heater, it is important that servicing is carried out annually.

In the event that the premises are not yet occupied turn off the gas and electricity supplies and leave instructional literature adjacent to gas meter.

## 7. Servicing

**WARNING:** Always switch off and disconnect electricity supply and close the gas service valve before carrying out any servicing work or replacement of failed components. Access doors on TE units are fitted with electrical interlocks however these alone **must not** be relied upon to prevent equipment operation during maintenance or servicing work.

### 7.1 General

Full maintenance should be undertaken not less than once per year. After any servicing work has been completed or any component replaced the air heater(s) must be fully commissioned and tested for soundness as described in Section 6.

### 7.2 Burner Maintenance

1. Refer to the Burner Supplement supplied with the heater.

### 7.3 Heat Exchanger Cleaning

1. Disconnect the gas supply at the inlet to the gas controls

assembly.

2. Unplug the electrical connections from the heater electrical panel to the burner.
3. Remove the nuts securing the burner to the heat exchanger and remove the burner.
4. (TE 41 & 61 only) Remove the fixings of the second section (*from the floor*) rear panel and hinge panel down to expose the heat exchanger clean out access plate. (TE21 only) Remove heater rear panel.
5. Remove the nuts securing the cleanout plate and remove.
6. Withdraw the heat exchanger baffles, if fitted.
7. Brush through heat exchanger tubes and remove loose material using a vacuum cleaner.
8. Reassemble all components in reverse order. Inspect all gaskets and replace if necessary.

### 7.4 Fan Assembly

1. (TE 41 & 61 only) Gain access to the fan section through the access door at the front left hand side. (TE 21) Remove lower side panels.
2. Inspect the fan blades to see that they are not damaged and that there is no excessive build up of deposits that could give rise to an imbalance. If necessary clean the fan blades using a stiff brush and vacuum cleaner.
3. (TE 41 & 61 only) Inspect the fan drive belts and replace if necessary. Lubricate the fan shaft ballrace bearings using a grease gun on the grease nipple of each bearing.

### 7.5 Replacement of Faulty Components

#### 7.5.1. Burner Components

1. Refer to the burner supplement supplied with the heater.

#### 7.5.2 Gas Controls Assembly

1. Refer to the burner supplement supplied with the heater.

#### 7.5.3 Main Fan Motors

(TE 41 & 61 only)

1. Release the motor mounting plate securing bolts and then release the belt tension by turning the tension adjustment screw clockwise. Remove the fan belts.
2. Disconnect the electrical connections from the motor and remove the motor. If required remove the motor pulley and fit same to the new motor.
3. Fit new motor and reassemble in reverse order.
4. Apply belt tension until a 12mm-15mm deflection is obtained when the centre of the belt is firmly depressed. See Figure below.

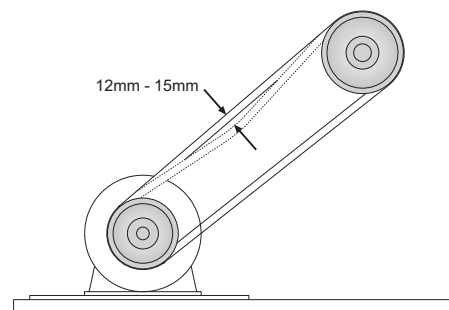

(TE 21 Only)

1. Remove fan assembly from motor shaft.
2. Disconnect the electrical connections from the motor and remove the motor.
3. Fit new motor and reassemble in reverse order.

#### 7.5.4 Main Air Fan(s)

Should it be necessary to replace one or both of the fans



proceed as follows.

#### (TE41 & 61)

1. Remove one or two heat exchanger module side panels close to the fan(s) to gain access to the top of the fan shaft. 2. Prevent fan shaft rotation with a spanner on the fan shaft flats and release the locking bolt (right hand thread) holding the fan assembly onto the shaft. Lift of the fan.

3. Fit new fan(s) and reassemble in reverse order. Ensure the loose key that prevents the fan assembly rotating on the fan shaft is refitted.

#### (TE21)

1. Remove one or two side panels to gain access to the top of the fan shaft. Remove set screw securing fan assembly to the motor shaft and remove fan.

2. Fit new fan(s) and reassemble in reverse order. Ensure the loose key that prevents the fan assembly rotating on the fan shaft is refitted.

### 7.5.4 Air Fan Pullies (TE41 & 61 only)

1. Release the motor mounting plate securing screws and then release the belt tension by turning the tension adjustment screw clockwise. Remove the fan belts.

2. Prevent fan shaft rotation with a spanner on the fan shaft flats and release the locking bolt (right hand thread) holding the pulley onto the shaft and remove pulley.

3. Fit new pulley and reassemble in reverse order. Ensure the loose key that prevents the pulley rotating on the fan shaft is refitted.

### 7.5.5 Fan and Limit Thermostats

#### 7.5.5.1 TE41 & TE61 - White Rodgers 5F464

**Note:** 2 fan/limit thermostats are fitted.

1. Release the single screw securing the fan and limit thermostat cover and remove cover by pulling forward.

2. Release wiring from screw terminals.

3. Remove the top side panel from the heater to gain access to the heat exchanger and release the thermostat sensing phial from its holder on top of the heat exchanger.

3. Remove the 2 screws securing the thermostat to the heater panel and withdraw thermostat and phial.

4. Reassemble new unit in reverse order referring to the heater wiring diagram to ensure correct wiring location.

5. Ensure that the fan and limit settings are as follows:-

Fan ON 50°C  
Fan OFF 30°C  
Limit 100°C

#### 7.5.5.2 TE21 - Honeywell L4064N

1. Release the single screw securing the fan and limit thermostat cover and remove cover by pulling forward.

2. Release wiring from screw terminals.

3. Remove the 2 screws securing the thermostat to the heater panel and withdraw thermostat and sensor.

4. Reassemble new unit in reverse order referring to the heater wiring diagram to ensure correct wiring location.

5. Ensure that the fan and limit settings are as follows:-

Fan ON 50°C  
Fan OFF 30°C  
Limit 100°C

1. Release the two screws securing the limit thermostat housing cover and remove cover by pulling forward.

2. Release the thermostat from the front cover, two screws

3. Pull off wiring connectors from under the thermostat.

4. Remove a central side panel from the heater exchanger section to gain access to the heat exchanger and release the thermostat sensing phial from its holder on top of the heat exchanger and withdraw thermostat and phial.

5. Reassemble new unit in reverse order referring to the heater wiring diagram to ensure correct wiring location.

6. Ensure that the setting is as follows:-

Limit 100°C

#### TE21

1. Release the two screws securing the limit thermostat housing cover and remove cover by pulling forward.

2. Release the thermostat from the front cover, two screws

3. Pull off wiring connectors from under the thermostat.

4. Remove heater side panels and release the thermostat sensing phial from its holder on the fan shroud and withdraw thermostat and phial.

5. Reassemble new unit in reverse order referring to the heater wiring diagram to ensure correct wiring location.

6. Ensure that the setting is as follows:-

Limit 50°C

**Fig 2 White Rodgers 5F464**

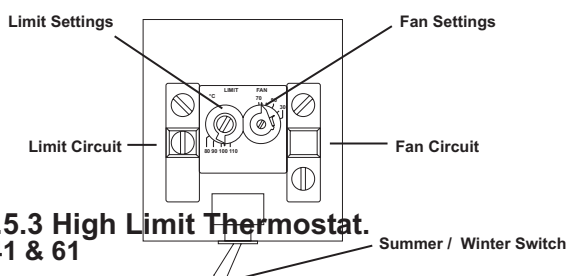

#### 7.5.5.3 High Limit Thermostat. TE41 & 61

## 8. Fault Finding

Refer also to the burner supplement supplied with the heater

<b>Fault</b>	<b>Cause</b>	<b>Action</b>
Main burner will not light	Electrical	1. Check electrical and gas supplies are ON. 2. Check controls are ON or calling for heat.
Main burner lights, but goes out before main fan comes on.	Electrical	1. Unit goes out on high limit - a. Check fan thermostat setting - See Section 7.5.5. b. Faulty fan thermostat - change c. Check limit thermostat setting - See Section 7.5.5. d. Faulty limit thermostat - change. 2. Faulty fan assembly - change. 3. Fan motor out on thermal overload. - Check running amps. See <i>specification sheet</i> .
Main fan runs continuously	Electrical	1. Summer/Winter switch set to Summer. 2. Faulty fan thermostat - change
Main fan fails to run	Electrical	1. Fan motor or capacitor failed - replace. 2. Fan thermostat faulty - replace. 3. Fan contactor failed - replace 4. Door interlock faulty

## 9. Short List of Parts

Refer to the burner supplement supplied with the heater and the enclosed short list of parts. Refer to Powrmatic Ltd for the details of any parts not listed.



HEATING DIVISION  
Winterhay Lane  
Ilminster, Somerset TA19 9PQ  
Tel: 01460 53535 Fax: 01460 52341

**BSI Registered Firm**

FM 414  
Ind. & Comm. Air Heaters;  
Air Moving Equipment;  
Flues & Chimneys; Natural  
Smoke & Heat Ventilators;  
Powered Supply & Extract  
Fans & Systems.

