

terrier belmont

Heating Controls

Thermostatic and Manual Radiator Valve range



terrier belmont

Heating Controls

New thermostatic and manual radiator valves with built-in energy saving solutions



With increasing demands on specifiers and installers to lead the way in saving energy at every possible opportunity, the innovative new Terrier Belmont range of radiator valves has arrived with perfect timing.

And because it's been developed and manufactured by Pegler Yorkshire in close consultation with the commercial and social housing sectors, it's a range that incorporates as standard many features which others charge as extra-cost options.

It's also a product which has grown out of the highly successful and industry-leading Terrier brand – for many years the UK's biggest name in domestic manual and thermostatic radiator valves.

Terrier Belmont offers the complete and cost-effective solution for both new and replacement installations. Comprehensive testing ensures every Terrier Belmont product meets stringent British and European standards for guaranteed performance, with TRVs approved to EN215 and Manual Valves approved to BS2767.



Key features

- Easy maintenance and servicing to minimise downtime: vital in commercial and social housing applications and satisfying the Tenants Charter.
- Enables compliance with revised Building Regulations to increase energy efficiency.
- Patented locking facilities on new tamperproof Terrier Belmont thermostatic radiator valves are highly effective at achieving greater energy efficiency in commercial applications such as schools, hospitals and colleges.
- Ideal and reliable cost-effective solutions for new and replacement installations.
- Onsite time savings thanks to innovative new no-drain feature: change working components glands without draining the system.
- New pre-setting TRV body prevents disruption of system balancing.
- British made: designed, engineered and manufactured in the UK.
- Exhaustive internal and external testing plus full compliance with all relevant UK and EU standards.

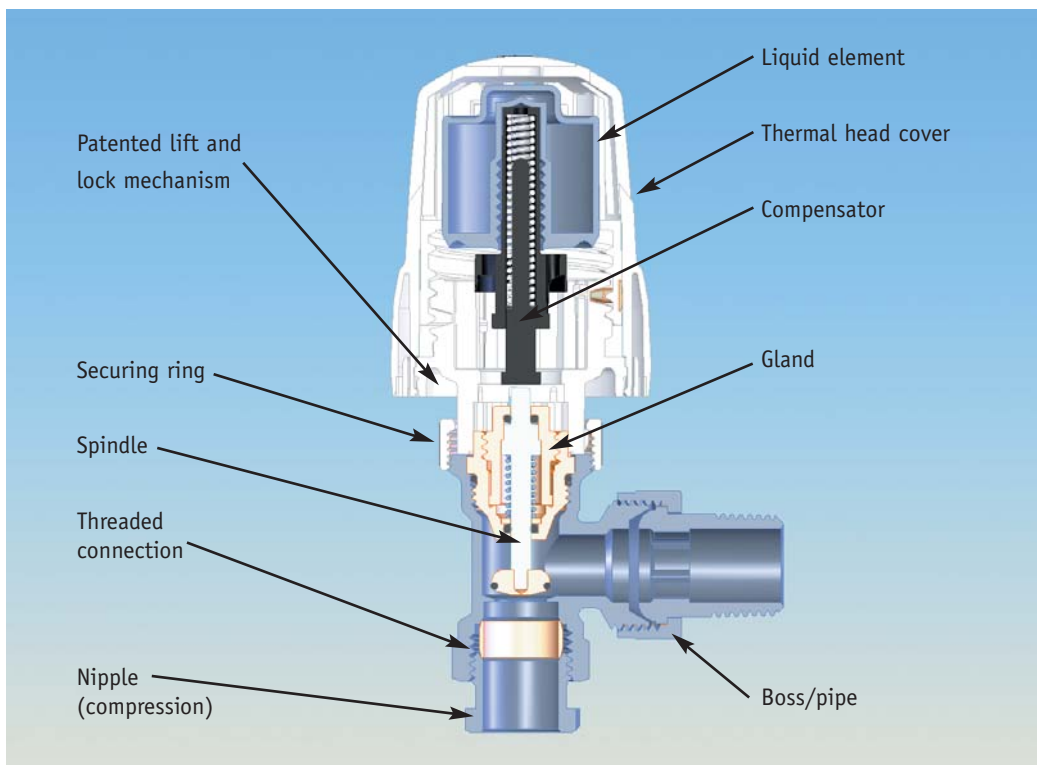

Thermostatic Radiator Valves



Page 4

Thermostatic Heads



Page 5

Valve Bodies and Accessories



Pages 6 and 7

Manual Radiator Valves



Pages 8 and 9

Flow Charts

Pages 10 and 11

Guarantee

Belmont valves are guaranteed for 5 years against manufacturing defects. To qualify for these guarantees, products must be installed in accordance with our instructions on specified applications.

Thermostatic Radiator Valves

Belmont thermostatic radiator valves have been designed for use on commercial through to residential properties including combi boiler installations.

The Belmont TRV benefits from a frost setting where the valve is opened automatically at 7°C to prevent the system freezing and has a built-in patented tamper resistant feature that is key operated. The TRV also employs a patented 'lift and lock' operation which prevents accidental adjustment.

Key features

- Control range of 11°C to 29°C
- Frost setting at 7°C
- Positive shut off for maintenance purposes
- Range limiting locking customised temperature setting
- Approved to EN215
- Suits copper and iron pipework*
- Matching manual radiator valves
- 10 bar rating suitable for combi boilers
- Horizontal and vertical mounting
- Patented unique lift and lock tamper resistant mechanism



B4452/4



B4451/4

Key operated tamper resistant feature (patented)

When in a locked down operation a further tamper resistant feature is available by adjusting the internal ring.

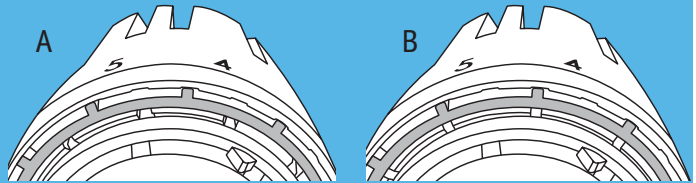
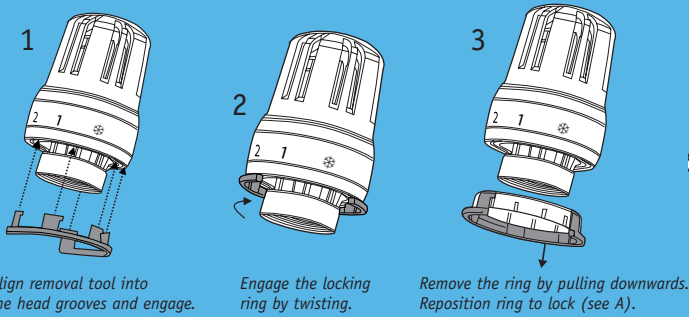

The head is now locked. To restore temperature adjustment to the head remove locking ring and refit as shown.

Reposition locking ring off-setting the lugs as shown and push firmly home.

TRV operation (patented)

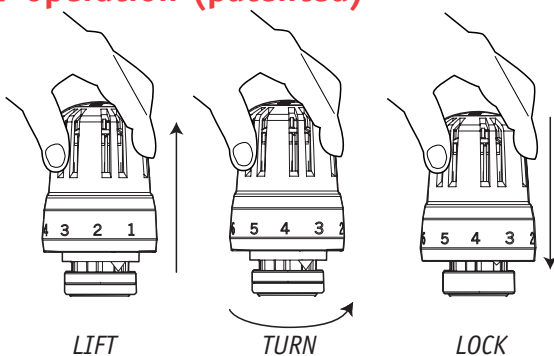

Specification clause

Belmont Complete TRV specification

Thermostatic radiator valves shall be approved to EN215, the thermal head will have a lift and lock mechanism and an anti adjustment lock down mechanism. The valve body will be of a chrome plate finish and with bi-directional reverse flow technology. The TRV will be suitable for central heating two pipe systems and suitable for use with up to 10 bar system pressure. The Complete TRV will be suitable for use with copper compression and screwed iron connections. The TRV will have a guarantee of 5 years against manufacturing defect and must be drawn from the Belmont range from Pegler Yorkshire.

TRV specifications

PATTERN NO.	SIZE AND DESCRIPTION	BOX QTY	CODE
B4451/4	1/2" x 15mm x 1/2", angle horizontal, TRV, chrome plate	1	686001
B4452/4	1/2" x 15mm x 1/2", angle vertical, TRV, chrome plate	1	686002

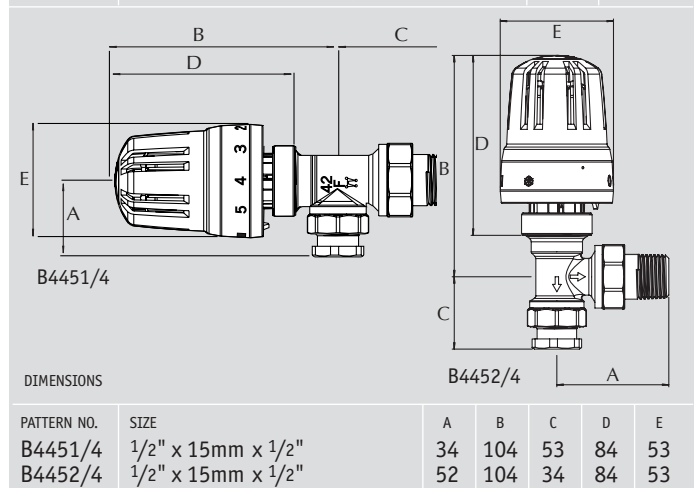

For flow chart information see pages 10 and 11

*Pegler Yorkshire have a range of push and press connectors in the Tectite range for use with plastic, carbon steel or copper piping.

Thermostatic Heads

Choice of different thermal heads is available: standard, remote sensing with 2m/8m capillary and remote adjusting in 2m, 5m and 8m capillary lengths. This makes the Belmont solution the first choice for those looking for the benefits of the latest products and service in a cost-effective package.



The remote adjusting unit is especially suited to low surface temperature radiators and can also be positioned away from the radiator when using the sensing head behind a permanent fixture.

Thermostatic head specifications and temperature settings

All dimensions are in mm. C dimension for body type – refer to page 3. Maximum diameter of head 63mm.

PATTERN NO.	DESCRIPTION	BOX QTY	CODE
B1301/4	Liquid TRV head with zero position	1	686005
B1401/4 (2m)	Liquid TRV head with 2m remote sensor	1	686006
B1401/4 (8m)	Liquid TRV head with 8m remote sensor	1	686009

PATTERN NO.	DESCRIPTION	BOX QTY	CODE
B1701/4 (2m)	Liquid TRV head with 2m remote adjuster	1	686011
B1701/4 (5m)	Liquid TRV head with 5m remote adjuster	1	686012
B1701/4 (8m)	Liquid TRV head with 8m remote adjuster	1	686013

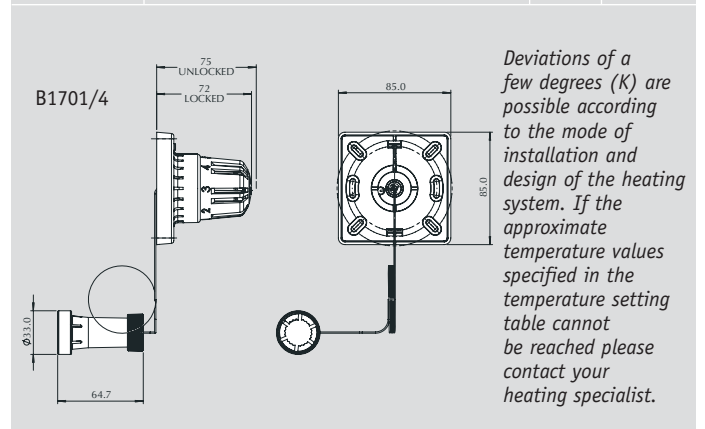
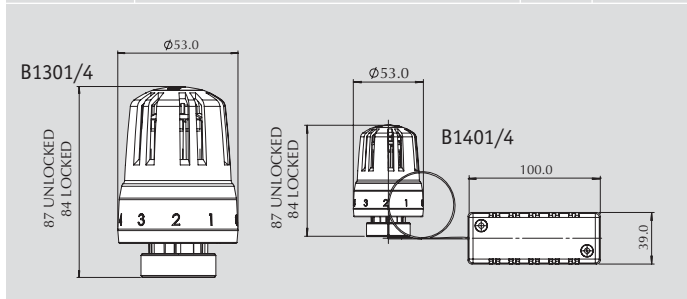

Deviations of a few degrees (K) are possible according to the mode of installation and design of the heating system. If the approximate temperature values specified in the temperature setting table cannot be reached please contact your heating specialist.

Temperature settings

0	*	1	2	3	4	5
Shut off	7°C	11–13°C	15–17°C	19–21°C	22–25°C	27–29°C

For flow chart information see pages 10 and 11

Thermostatic Radiator Valve Bodies

Belmont thermostatic radiator valves comprise of three different body patterns: angle, horizontal and straight. They have a choice of pre-setting and non pre-setting options.

Key features

- Approved to EN215
- Suits copper and iron pipework direct*
- 10 bar rating suitable for combi boilers
- Horizontal and vertical mounting
- Insert removal and replacement without draining down when using special tool
- All valves are suitable for 2 pipe systems

Specification clauses

Belmont Bodies specification

Thermostatic radiator bodies shall be approved to EN215. The valve body will be of a chrome plate finish and with bi-directional reverse flow technology. The TRV will be suitable for central heating two pipe systems and suitable for use with up to 10 bar system pressure. The TRV will be suitable for use with copper compression and screwed iron connections. The TRV will have a guarantee of 5 years against manufacturing defect and must be drawn from the Belmont range from Pegler Yorkshire.

Belmont Preset Bodies specification

Thermostatic radiator bodies shall be approved to EN215. The valve body will be of a Chrome plate finish and with bi-directional reverse flow technology. The TRV will be suitable for system balance with built-in preset mechanism. The TRV will be suitable for central heating two pipe systems and suitable for use with up to 10 bar system pressure. The TRV will be suitable for use with copper compression and screwed iron connections. The TRV will have a guarantee of 5 years against manufacturing defect and must be drawn from the Belmont range from Pegler Yorkshire.

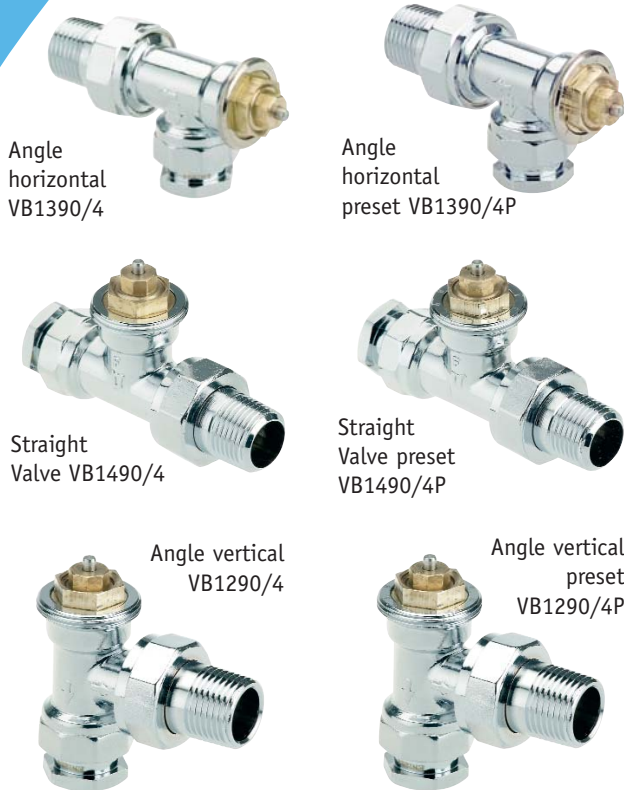

*Pegler Yorkshire has a range of push and press connectors in the Tectite range for use with plastic, carbon steel or copper piping.

Angle vertical body specifications and dimensions (mm)

PATTERN NO.	DESCRIPTION	SIZE	Dimensions			BOX QTY	CODE
			A	B	C		
VB1290/4	Angle vertical	1/2"/15mm x 1/2"	53	36	34	1	686032
VB1290/4P	Angle vertical preset	1/2"/15mm x 1/2"	53	36	34	1	686082
VB1290/4	Angle vertical	3/4"/22mm x 3/4"	63	37	38	1	686033
VB1290/4P	Angle vertical preset	3/4"/22mm x 3/4"	63	37	38	1	686083

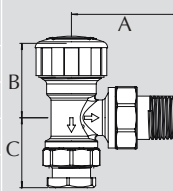

Angle horizontal body specifications and dimensions (mm)

PATTERN NO.	DESCRIPTION	SIZE	Dimensions			BOX QTY	CODE
			A	B	C		
VB1390/4	Angle horizontal	1/2"/15mm x 1/2"	34	36	53	1	686030
VB1390/4P	Angle horizontal preset	1/2"/15mm x 1/2"	34	36	53	1	686080
VB1390/4	Angle horizontal	3/4"/22mm x 3/4"	38	37	63	1	686031
VB1390/4P	Angle horizontal preset	3/4"/22mm x 3/4"	38	37	63	1	686081

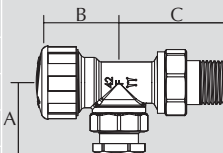

Straight valve body specifications and dimensions (mm)

PATTERN NO.	DESCRIPTION	SIZE	Dimensions			BOX QTY	CODE
			A	B	C		
VB1490/4	Straight valve body	1/2"/15mm x 1/2"	43	41	51	1	686034
VB1490/4P	Straight valve body preset	1/2"/15mm x 1/2"	43	41	51	1	686084
VB1490/4	Straight valve body	3/4"/22mm x 3/4"	45	47	62	1	686035
VB1490/4P	Straight valve body preset	3/4"/22mm x 3/4"	45	47	62	1	686085

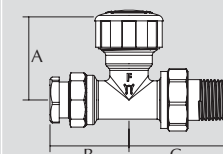

For flow chart information see pages 10 and 11.

Pre-setting mechanism

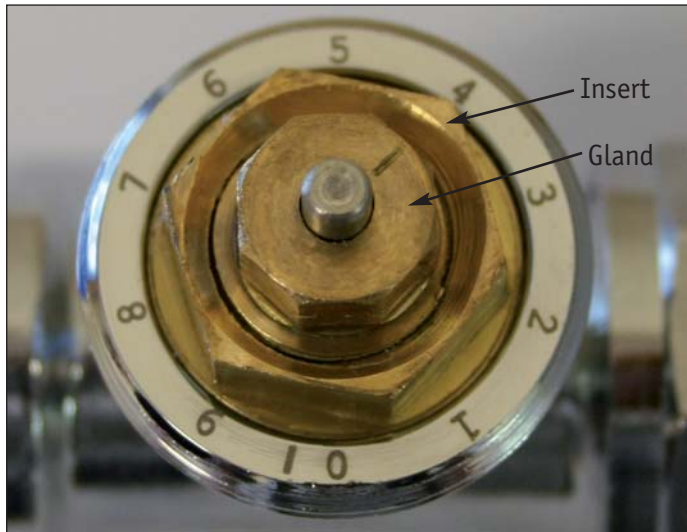

Balancing your system can be laborious and time consuming. Using a lockshield to balance the system is common, but with accidental or intentional adjustment, the system can become unbalanced, reducing the efficiency of your heat output. The closing of a lockshield, the removal of radiator for replacement or decorating purposes can affect the system.

Using a presetting valve provides a unique solution without installing any additional products other than a TRV. The presetting valve should be applied on all radiators ideally on the flow end. On each valve the gland can be adjusted to control flow allowing pressure to be redirected to the next radiator in line. This is repeated on all radiators in the application allowing the system to be balanced.

This benefit allows the lockshield to become an isolating valve and ensures that any accidental adjustment can be easily corrected, additionally when radiators are removed or replaced the setting on the valves will remain, saving precious time and avoiding commissioning.

Valve system using TRV

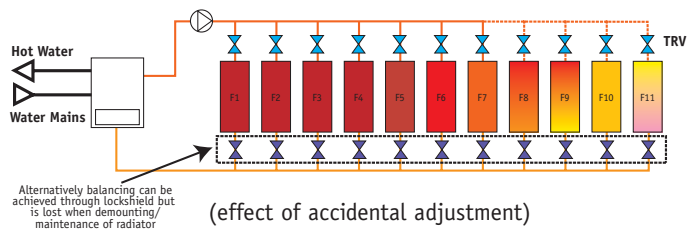

Valve system using pre-setting TRV

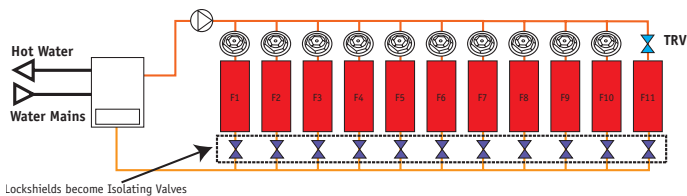

Accessories

Rely on Pegler Yorkshire to supply dedicated accessories and tools for installation and maintenance of the Terrier Belmont range.



PATTERN NO.	DESCRIPTION	SIZE	BOX QTY	CODE
N/A	Belmont TRV Security Clip	One size	20	686102
N/A	Security Clip Release Tool	One size	1	686103
N/A	Retaining Clips for Capillary Tube	One size	10 sets	686104
N/A	Iron Pipe Connection without Nut	1/2"	10	686105
N/A		3/4"	10	686106

PATTERN NO.	DESCRIPTION	SIZE	BOX QTY	CODE
N/A	Copper Compression Fitting (Black cap only)	22mm for 3/4" valve bodies	10	686107
N/A	Remote Sensor Housing	One size	1	686117
RG1205/3	Gland/head Removal Tool (III)	One size	1	686100
RG1205/4	Gland/head Removal Tool (IV)	One size	1	686200
B1301-0/4 B1401-0/4	Locking/Limiting Pins	One size	20	686101

Manual Radiator Valves

The new manual radiator valve range offers both traditional handwheel and lockshield styles, along with a new concealed lockshield style in both angled and straight patterns.

A 'no drain solution' on manual valves allows the spindle O ring's seal to be changed with the system still full of water. The whole headwork may be changed without draining by using a gland removal tool. These features minimise down time, saving both cost and time on site.

Innovations introduced for the first time include a concealed lockshield cap on the manual radiator valve, which requires an allen key to adjust the flow. The lockshield provides tamper resistance, this prevents accidental or vandal adjustment in public areas and ensures protection for system balance.

Key features

- Suits a wide range of commercial applications
- Valves can be serviced without draining the system
- Approved to BS2767-10
- Concealed lockshield with allen key adjustment
- Compression or iron end connection direct*



Tamper resistant lockshield adjustment by allen key



Wheel head angle pattern specifications and dimensions (mm)

PATTERN NO.	DESCRIPTION	SIZE	Dimensions			BOX QTY	CODE	
			A	B	C			
97WH	Matt brass	1/2"/15mm x 1/2"	53	63	35	1	680001	
97WH	Matt brass	3/4"/22mm x 3/4"	63	56	56	1	680004	
97WHCP	Chrome plate	1/2"/15mm x 1/2"	53	63	35	1	680007	
97WHCP	Chrome plate	3/4"/22mm x 3/4"	63	56	56	1	680010	

For flow chart information see pages 10 and 11. *Pegler Yorkshire have a range of push and press connectors in the Tectite range for use with plastic, carbon steel or copper piping.

Wheel head straight pattern specifications and dimensions (mm)

PATTERN NO.	DESCRIPTION	SIZE	Dimensions		BOX QTY	CODE
			A	B		
98WH	Matt brass	1/2"/15mm x 1/2"	105	78	1	681001
98WH	Matt brass	3/4"/22mm x 3/4"	130	83	1	681004
98WHCP	Chrome plate	1/2"/15mm x 1/2"	105	78	1	681007
98WHCP	Chrome plate	3/4"/22mm x 3/4"	130	83	1	681010

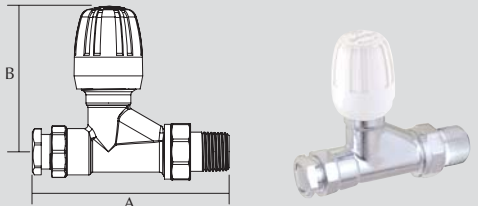

Lockshield drainoff angle valve specifications and dimensions (mm)

PATTERN NO.	DESCRIPTION	SIZE	Dimensions			BOX QTY	CODE
			A	B	C		
97DLSCP	Chrome plate	1/2"/15mm x 1/2"	81	63	35	1	680009

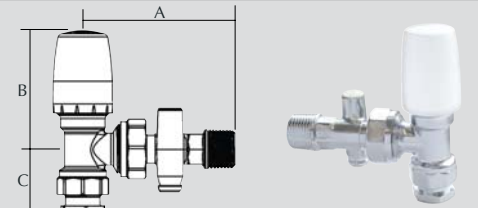

Lockshield angle valve specifications and dimensions (mm)

PATTERN NO.	DESCRIPTION	SIZE	Dimensions			BOX QTY	CODE
			A	B	C		
97LS	Matt brass	1/2"/15mm x 1/2"	53	63	35	1	680002
97LS	Matt brass	3/4"/22mm x 3/4"	61	64	41	1	680005
97LSCP	Chrome plate	1/2"/15mm x 1/2"	53	63	35	1	680008
97LSCP	Chrome plate	3/4"/22mm x 3/4"	61	64	41	1	680011

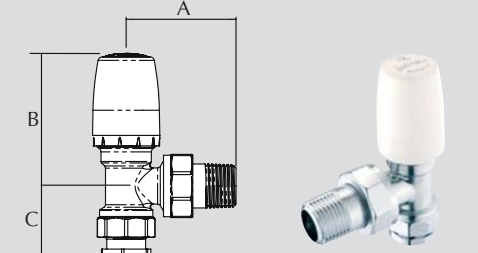

Lockshield straight valve specifications and dimensions (mm)

PATTERN NO.	DESCRIPTION	SIZE	Dimensions		BOX QTY	CODE
			A	B		
98LS	Matt brass	1/2"/15mm x 1/2"	105	78	1	681002
98LS	Matt brass	3/4"/22mm x 3/4"	130	83	1	681005
98LSCP	Chrome plate	1/2"/15mm x 1/2"	105	78	1	681008
9866CP	Chrome plate	3/4"/22mm x 3/4"	130	83	1	681011

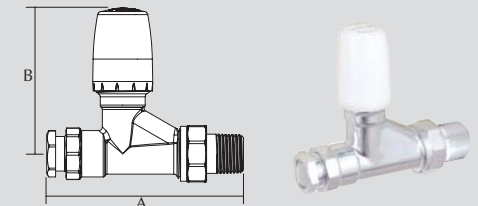

Lockshield tamperproof angle valve specifications and dimensions (mm)

PATTERN NO.	DESCRIPTION	SIZE	Dimensions			BOX QTY	CODE
			A	B	C		
LS351/4	Chrome plate	1/2"/15mm x 1/2"	53	39	35	1	686050
LS351/4	Chrome plate	3/4"/22mm x 3/4"	61	40	41	1	686051

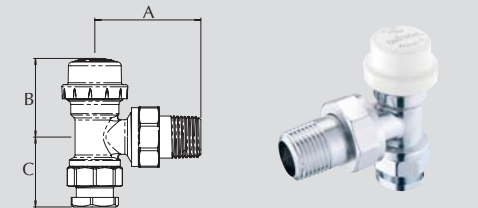

Lockshield tamperproof straight valve specifications and dimensions (mm)

PATTERN NO.	DESCRIPTION	SIZE	Dimensions		BOX QTY	CODE
			A	B		
LS352/4	Chrome plate	1/2"/15mm x 1/2"	105	54	1	686052
LS352/4	Chrome plate	3/4"/22mm x 3/4"	130	59	1	686053

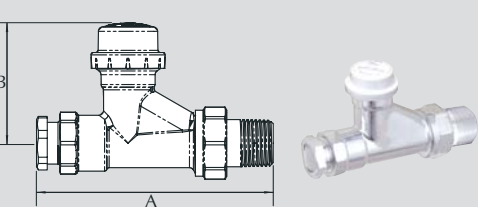

For flow chart information see pages 10 and 11

Technical specifications

TRV

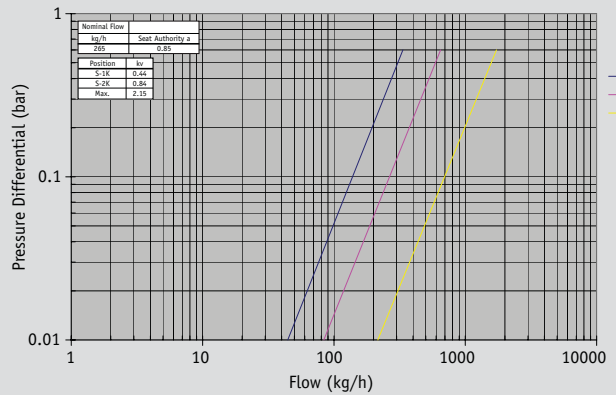
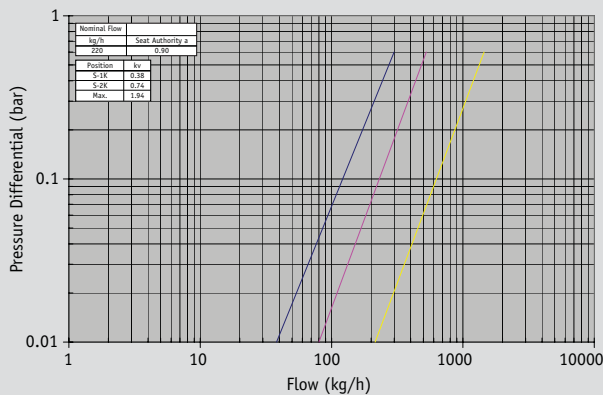
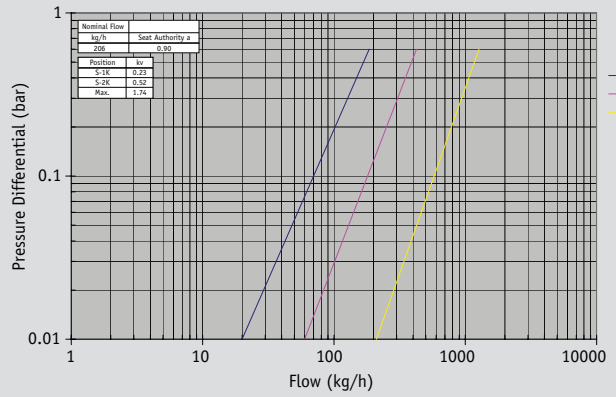
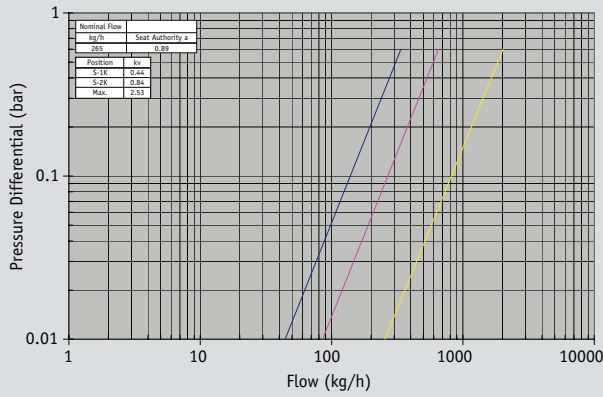

TRV - preset

3/4" Angle & Reverse Angle Pattern Forward & Reverse Flow Pre-setting

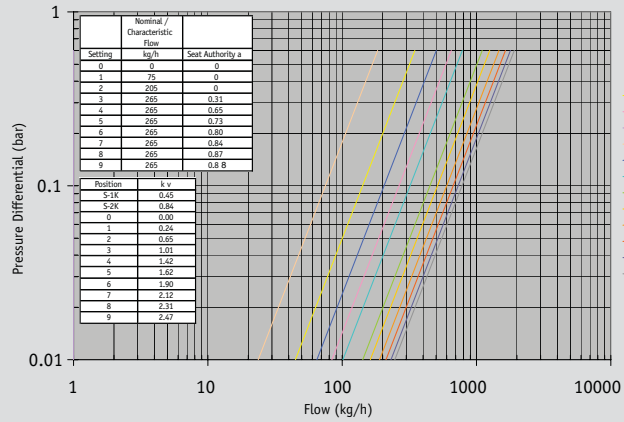

1/2" Angle and Reverse Angle Pattern Forward Flow Pre-setting

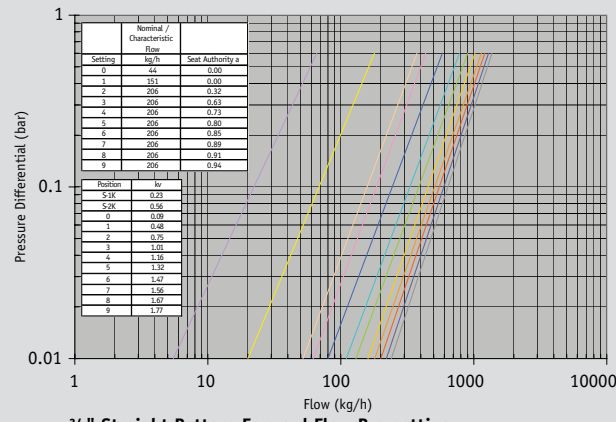

1/2" Angle and Reverse Angle Pattern Reverse Flow Pre-setting

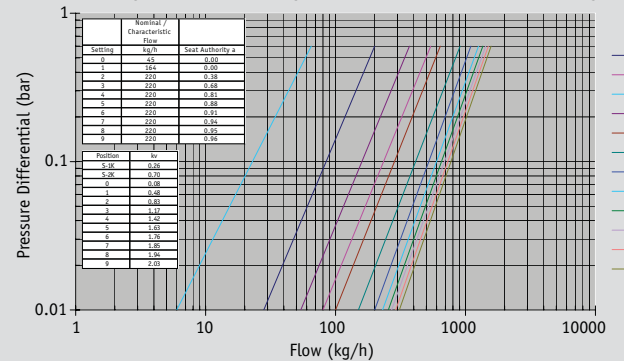

3/4" Straight Pattern Forward Flow Pre-setting

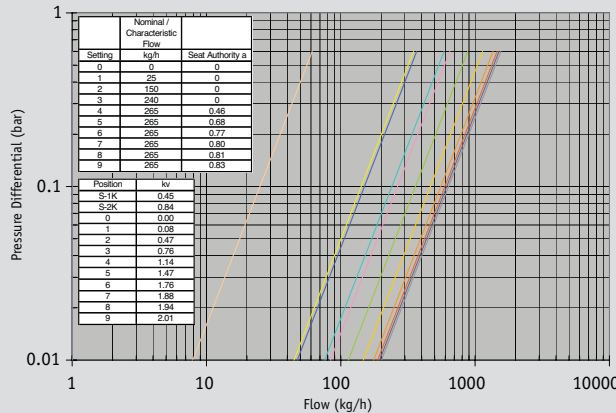

For product details see pages 6 and 7

Technical overview

Nominal flow rates	
1/2" angle and reverse angle forward flow	206kg/h
1/2" angle and reverse angle reverse flow	220kg/h
1/2" straight pattern forward and reverse flow	195kg/h
3/4" patterns	265kg/h
Maximum static pressures	10bar at 120°C
Maximum differential pressures	0.6bar
Hysteresis	0.5k
Differential pressure influence	
All variants forwards	0.15k
All variants reverse	-0.25k
Water temperature influence	
Fixed thermal head	0.9k
Remote sensing and remote adjusting heads	0.5k
Response time	
All TRV head variants - vertical	24 minutes
All TRV head variants - horizontal	20 minutes

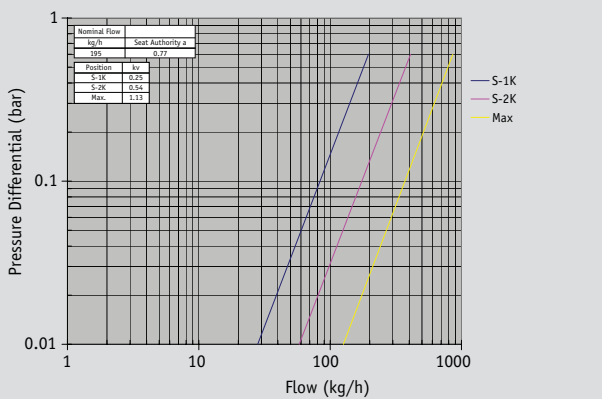
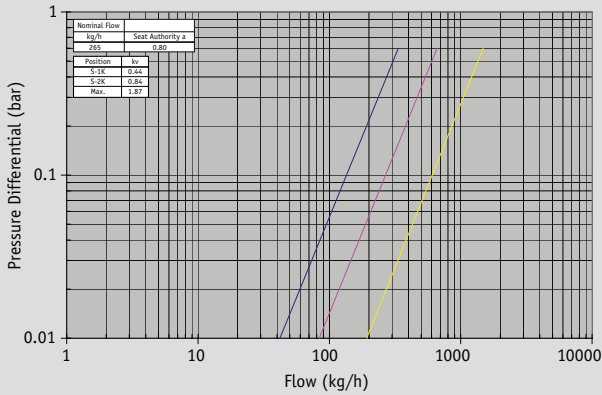

Manual radiator valves

Manual Handwheel and Lockshield Flows

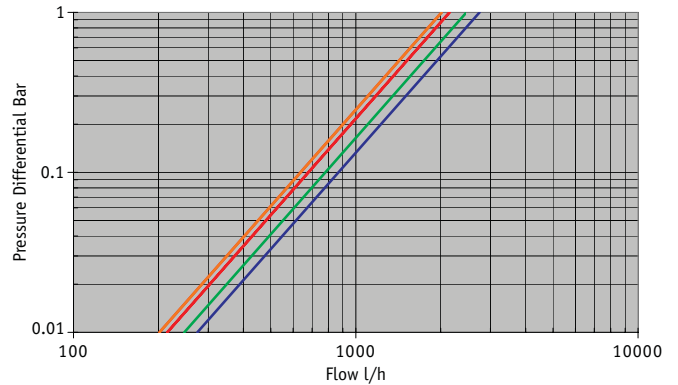

Pressure (Bar)	Flow (l/h)	Pressure (Bar)	Flow (l/h)	Pressure (Bar)	Flow (l/h)	Pressure (Bar)	Flow (l/h)
0.01	214.8	0.01	276.4	0.01	258.4	0.01	203.9
1	2148.0	1	2764.0	1	2584.3	1	2039.1
kv	2.15	kv	2.76	kv	2.58	kv	2.04

For product details see pages 8 and 9

Concealed Lockshield Flows

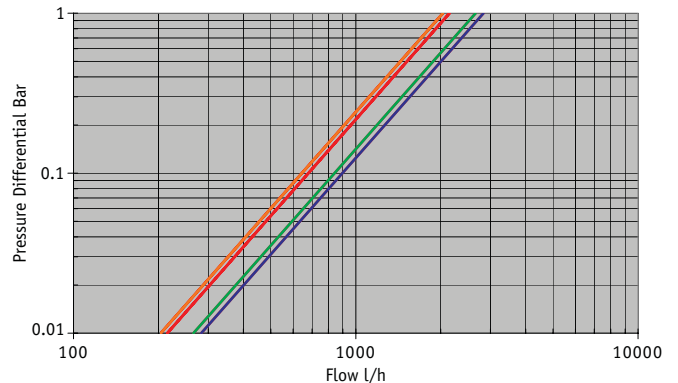

Pressure (Bar)	Flow (l/h)	Pressure (Bar)	Flow (l/h)	Pressure (Bar)	Flow (l/h)	Pressure (Bar)	Flow (l/h)
0.01	213.1	0.01	289.9	0.01	267.8	0.01	203.1
1	2130.9	1	2898.7	1	2678.0	1	2030.7
kv	2.13	kv	2.90	kv	2.68	kv	2.03

For product details see pages 8 and 9

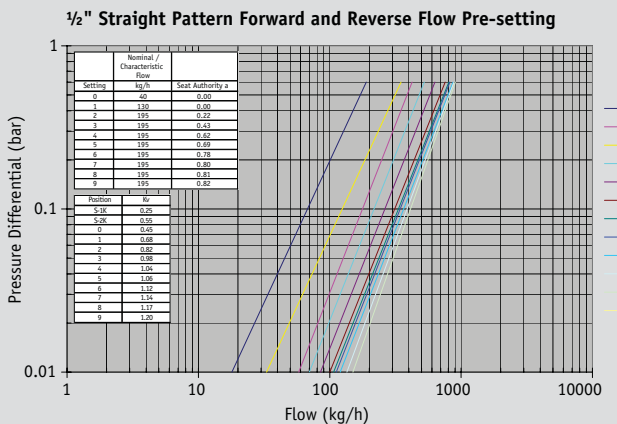
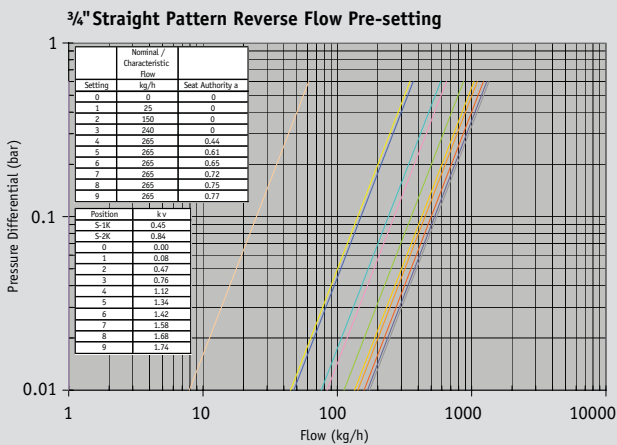

For product details see pages 6 and 7



terrier belmont

Heating Controls

For further information, please contact your appropriate Sales Office

UK

Northern team:
Telephone: 0870 1200281 Fax: 01302 560108

Southern team:
Telephone: 0870 1200282 Fax: 01302 560458

Western team:
Telephone: 0870 1200283 Fax: 01302 560109

Eastern team:
Telephone: 0870 1200282 Fax: 01302 560458

Email: uk.sales@pegler.co.uk

EXPORT

Telephone: +44 (0) 1302 855656

Fax: +44 (0) 1302 730513

Email: export@pegler.co.uk

Technical helpline: 0870 1200285

The perfect commercial partnership



Pegler

Pegler is an expert in the production of Taps, Mixers and Valve products. It boasts an unrivalled track record for integrity, quality, reliability and innovation.



Yorkshire

Yorkshire is a specialist in the production of metal plumbing and heating fittings. It has an established reputation for manufacturing quality products.



LUXURY TAP SOLUTIONS



HEATING CONTROLS



VALVES AND FITTINGS



UTILITY TAP SOLUTIONS



INTEGRAL SOLDER RING FITTINGS



THE PUSH-FIT JOINTING SYSTEM



THE PRESS-FIT JOINTING SYSTEM



COMPRESSION FITTINGS



END FEED FITTINGS



COMMERCIAL VALVES



Pegler

Pegler Limited, St. Catherine's Avenue, Doncaster, South Yorkshire, DN4 8DF, England.

www.pegler.yorkshire.co.uk

Registered Company No. 01194543. Place of Registration: England

All brand names and logo styles are registered trademarks.

Maintaining a policy of continual product development, Pegler Ltd reserves the right to change specifications, design and materials of products listed in this leaflet without prior notice. LIT.REF: 880111.05.08