

# PARAGON QUARTET

## OWNER MANUAL

### INCLUDES USER INSTRUCTION & INSTALLATION & MAINTENANCE INSTRUCTIONS

Please read these instructions carefully before you start installing or using this  
appliance

Keep this booklet handy for future reference

**This appliance is  
for use in Great Britain or  
IRELAND only**

A QUALITY PRODUCT  
FROM PARAGON FIRES

PARAGON FIRES  
TELFORD  
SHROPSHIRE  
TF7 4QJ

# Paragon Quartet Instructions

## CONTENTS

PAGE

### USERS INSTRUCTIONS

<b>SECTION ONE Introduction</b>	Consumer Protection Information .....	3
	Heath & Safety Notice .....	3
	Introduction .....	3
	Important Information .....	4
<b>SECTION TWO Operating Appliance</b>	Lighting the Appliance .....	5
	Replacing Hand Set Battery .....	5
	Replacing Appliance Battery .....	6
<b>SECTION THREE Cleaning</b>	Cleaning Trim and Fret or Fascia .....	7
	Cleaning Black Painted Surfaces .....	7
	Cleaning Pilot Assembly .....	7
	Cleaning Glass panel .....	7
	Removing Glass Panel .....	8
<b>SECTION FOUR Fuel Bed Cleaning &amp; Layout</b>	Cleaning Fuel Bed .....	8
	Pebble Fuel Bed Layout .....	9
	Granite Fuel Bed Layouts panel .....	10
<b>SECTION FIVE General Points</b>		11
INSTALLATION INSTRUCTIONS		
<b>SECTION SIX Appliance Data</b>		12
<b>SECTION SEVEN Regulations and Warnings</b>		14
<b>SECTION EIGHT Siting the Appliance</b>	Flue (Class1) .....	14
	Installation Compatibility (plinth/hole in wall) .....	14
<b>SECTION NINE To Install Appliance</b>	Checking the Flue and Fire Opening .....	14
	Gas Supply Routing .....	15
	Glass Removal .....	15
	Connecting to the Gas Supply .....	15
<b>SECTION TEN Checking Fire Operation</b>	Check Gas soundness .....	16
	Checking Product Clearance .....	16
	Fitting Trim/Fascia .....	17
	Advice To Customer .....	17
MAINTENANCE INSTRUCTIONS		
<b>SECTION ELEVEN Maintenance</b>	General .....	18
	Pilot Linting .....	18
	To remove the burner tray .....	18
	Replacement of gas control .....	18
	Replacement of injectors .....	18
	Replacement of Oxy-pilot assembly .....	19
	Replacement of Control Unit (EDB) .....	19
<b>SECTION TWELVE Wiring Diagram</b>		19

# Paragon Quartet Users Instructions

## SECTION ONE Introduction

### **Consumer Protection Information**

As manufacturers and suppliers of heating products, we take every care, as far as is reasonably practicable, that these products are so designed and constructed as to meet the general safety requirement when properly used and installed. To this end, our products are thoroughly tested and examined before despatch.

**IMPORTANT NOTICE:** Any alteration that is not approved by the appliance manufacturer could invalidate the approval of the appliance, operation of the warranty and could affect your statutory rights.

### **Health and Safety Notice**

#### **Important**

This appliance could contain some of the materials, indicated below, that could be interpreted as being injurious to health and safety. It is the users / installers responsibility to ensure that the necessary personal protective clothing is worn when handling these materials, see below for information.

**Artificial Fuels, Mineral Wool, Insulation Material, Refractory/Ceramic Fibres, Glass Yarn - may be harmful if inhaled, may be irritating to skin, eyes, nose and throat.**

**When handling avoid inhaling and contact with skin or eyes. Use disposable gloves, facemasks and eye protection. After handling wash hands and other exposed parts. If a vacuum is used for cleaning the coals or cleaning after servicing / installation it is recommended that it be of the type fitted with a HEPA filter.**

**Disposal of refractory/ceramic materials.** To keep dust to a minimum these materials should be securely wrapped in polythene and be clearly labelled 'RCF waste'. These materials are not classified as 'hazardous waste and should be disposed of at a site licensed for the disposal of industrial waste.

## INTRODUCTION

- The PARAGON QUARTET as been designed and tested to the requirements of EN 613 and is suitable for use in GB (Great Britain) and IE (Ireland).
- The PARAGON QUARTET incorporates a single gas control, which selects ignition pilot, with variable setting between low and high settings and is operated via remote control. The system is powered by a battery pack; therefore no mains electrical supply is required.
- Like all appliances incorporating an aerated burner a low frequency noise may be heard, this may be more noticeable on the low setting.
- The PARAGON QUARTET incorporates a safety device in the form of an Oxygen Depletion System, which constantly monitors the oxygen in the room and will cause the fire to switch off if the oxygen level reduces, for instance due to insufficient ventilation or a blocked flue. If this regularly occurs do not attempt to relight the appliance until a qualified engineer has checked it, the problem may not be due to lack of air or a defective flue.
- The pilot can be left on (standby setting) or the pilot can be extinguished and relit each time the fire is used.
- To obtain a authentic fire sound, a noise will be noticeable from the burner.

# Paragon Quartet Users Instructions

## SECTION ONE Introduction Continued

The PARAGON QUARTET is battery operated; therefore no mains electrical supply is required. Power to the appliance is provided by 6 high power alkaline 1.5V batteries (AA size) (a spare set of 6 AA batteries is supplied with the appliance); these batteries can be changed to Nickel Metal Hydride rechargeable batteries providing they have a minimum capacity of 2200 mAh. A set of 6 high power alkaline 1.5V batteries (AA size) would give in the order of 200 -380 operations while 6 rechargeable batteries when fully charged would give approximately 200-300 operations. These figures are only given for guidance and may vary depending on how the appliance is used and the battery manufacturer and quality.

A special long life lithium battery is available as an optional extra and would be expected to give in excess of 12 months normal use (a minimum of 1000 operations), however it is not subject to the guarantee. For more information call the telephone number located on the back of this booklet. Using the standby facility when the appliance is switched off for short periods can extend battery life. The standby facility switches off the mains gas supply to the appliance but the pilot remains alight.

An audible double bleep warning indicates that the appliance batteries need changing or charging (if rechargeable batteries have been used).

**Important: Batteries should be changed or recharged as soon as possible as the appliance will not light if the battery power gets to low.**

### IMPORTANT INFORMATION

- The appliance is for use on Natural Gas (G20 @ 20mbar) only.
- The chimney or flue (unless new or previously used with a gas appliance) shall be swept before installation if it has been used for solid fuel.
- The fire front (fret) or fascia supplied must be used with this appliance.
- Failure to install appliance correctly could lead to prosecution.  
In GB (Great Britain), the appliance must be installed by a competent person i.e. CORGI-registered, in accordance with the GAS SAFETY (INSTALLATION AND USE) REGULATIONS, The Building Regulations (or The Building Regulations (Scotland) or The Building Regulations (Northern Ireland)) and The Current I.E.E. Wiring Regulations, if appropriate.  
In IE (Ireland), the appliance must be installed by a competent person and installed in accordance with the current edition of I.S.813 Domestic Gas Installation, the current Building Regulations and the current ETCI rules for electrical installation, if appropriate.
- The glass front of this fire acts as a dress guard, conforming to BS 1945 (1997) however; a fireguard conforming to BS6539 (1997) must be used to protect young children, the elderly or infirm.
- The appliance MUST NOT be used with the glass safety screen removed or if it is damaged or cracked.
- During initial firing, an odour may be evident. This is the starch binder used during the manufacture of the fibre components of the fire, and there are **no harmful** effects produced.
- During the normal operation of the fire some black staining may appear on some parts of the fuel bed. This is quite normal and adds to the appearance of the appliance. However, if excessive black staining does occur it may be due to the fuel bed being incorrectly laid. This should be checked prior to contacting a service engineer.

# Paragon Quartet Users Instructions





## SECTION ONE Introduction Continued

- Care must be taken to prevent any damage being caused to surrounding soft furnishing or decoration; e.g. many embossed vinyl wall coverings may become discoloured if placed too close to the appliance. Combustible material i.e. wall panelling or wallpaper must be removed from behind the fire and fire trim.
- It is advised that this appliance is serviced annually; as it is more likely to provide trouble-free operation.
- In GB (Great Britain) the fire does not normally require purpose built ventilation, but if for any special reason purpose built ventilation is provided it should be checked periodically to ensure freedom from obstructions.
- In IE (Ireland) permanent ventilation must comply with the current edition of IS813.

## SECTION TWO Operating the Appliance

**Before attempting to operate the appliance check that nothing has been placed in front of the appliance that may interfere with the remote sensor operation.**

**To light the appliance using the remote hand set:**

- Point the remote control hand set in the direction of the appliance and simultaneously press the buttons marked '●' and 'standby'. Continue to hold in these two buttons until a 'bleep' is heard (approximately 2-3 sec.) and then release these buttons. The appliance will automatically go through the ignition sequence and the pilot should ignite. Once the pilot is alight the appliance will automatically go to the high setting (approximately 20-25sec).
- If the ignitor stops sparking and the pilot fails to light press the ● button before repeating this procedure.
- The appliance can be adjusted up or down by pressing the appropriate button  (low setting) or  (high setting). These buttons have a dual function. If they are pressed until a 'bleep' is heard and then released immediately the appliance will automatically go to the maximum  or minimum settings . On the other hand if the button is not released gradual adjustment is made until the button is released or until the maximum or minimum setting is reached.
- To switch off the appliance press the ● button. If the appliance is to be switch off for a short period it is recommended that the 'standby' button be used, this switches the main burner off but leaves the pilot on and will extend battery life.
- The appliance can be switch off with out using the hand set by removing the appliance batteries located behind the ash pan cover. When the batteries are removed there will be a delay (up 3minutes) after which double bleeps may be heard and shortly after the appliance will extinguish. Ensure that the battery is reconnect once the fire as been extinguished. The appliance cannot be operated without the use of the handset.

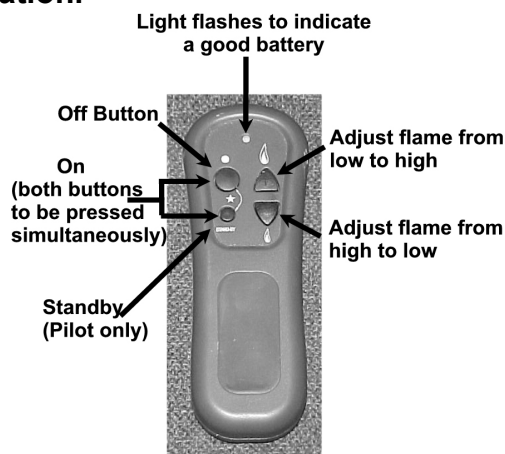

**NOTE: If the fire is extinguished for any reason wait 3 minutes before relighting.**

### LOW BATTERY INDICATION (HAND SET)

If while pressing any of the buttons on the remote hand set the low battery indicator lamp either stops flashing or appreciably slows then the battery should be changed.

# Paragon Quartet Users Instructions

## SECTION TWO Operating the Appliance Continued

### TO REPLACE BATTERY IN HAND SET (9V SIZE MN1604 OR 6F22)

Remove the cover from the rear of the handset and fit replacement battery. Take care not to stain the battery connections.

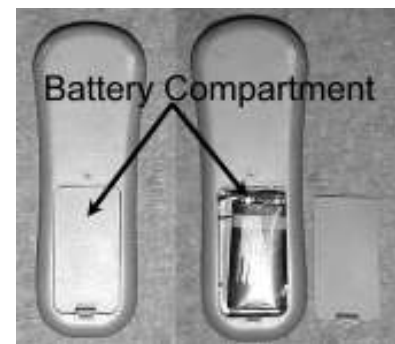

### LOW BATTERY INDICATION (APPLIANCE)

If you hear a double 'bleep' sound come from the appliance this indicates the appliance battery pack is low and should be changed as soon as possible. The appliance will continue to work normally for a short period but if the warning is ignored you may experience difficulty lighting the appliance or the appliance may automatically switch off for no apparent reason.

**NOTE:** The appliance cannot be used when the battery is completely discharged.

### TO REPLACE APPLIANCE BATTERIES (6 High Power Alkaline AA 1.5V)

(Rechargeable batteries can be used providing they are a nickel metal hydride type 1.5V AA with a minimum capacity of 2200mAh).

(A long life lithium battery is available as an optional extra call the number shown on the last page of these instructions for further information).

- Lift off fret and ash pan.
- The battery power pack or holder is located at the left hand side of the burner; carefully slide the battery holder forward and replace the six high power alkaline AA batteries as a complete set or recharge as appropriate. **WARNING, batteries will overheat if fitted incorrectly, when fitting the batteries ensure that they are fitted as per the marking on the rear of the holder (i.e. minus of battery against spring).** If rechargeable batteries are used they MUST be a Nickel Metal Hydride type with a minimum capacity of 2200mAh.

- If the appliance is fitted with the special lithium battery (optional) disconnect the wires at the battery connector and replace ensuring the connection is made correctly.

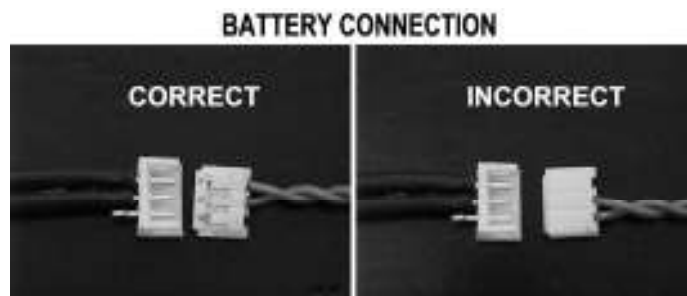
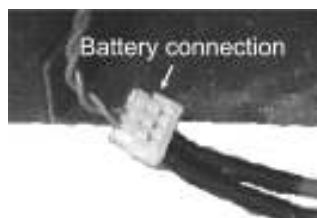

- Important:** Place the battery pack or holder inside the insulation blanket and ensure that it is placed flat to the left hand side of the appliance with the leads facing to the left. Place battery lead into clip as shown and refit fret and ash pan cover.



# Paragon Quartet Users Instructions

## SECTION THREE **Cleaning**

### **Warning: -**

Before you clean any part of the appliance ensure that the appliance is turned off and cold.

### **CLEANING: TRIM or FASCIA**

Abrasive or chemical cleaner should **never** be used.

### **CLEANING: BLACK PAINTED SURFACES**

- These surfaces should be dusted regularly and any marks removed with a soft cloth.
- Abrasive or chemical cleaner should **never** be used.

### **CLEANING: PILOT ASSEMBLY**

(Before cleaning ensure that the appliance is turned off and cold)

In some instances you may experience ignition problems even when the appliance is new. This may be due to the aeration hole in the pilot body (see photograph) being partial blocked with dust, pet hairs, or other foreign matter. The source of this debris could be such things as carpet fibres, decorating or pet etc.

To gain access to the pilot remove the ash pan cover and fret or fascia.

The pilot is located on the right hand side of the appliance, any debris in or around the aeration hole should be removed using the nozzle of a vacuum cleaner. It is advisable not to blow the debris into the hole as this may cause more of a restriction and not rectify the problem.

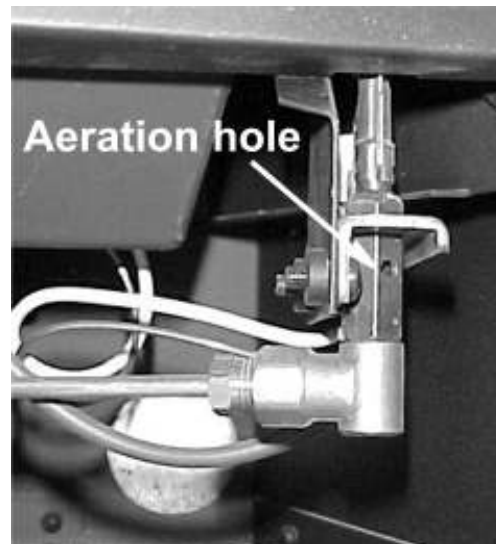

**Note: - Take care when cleaning in this area so as not to damage the pilot assembly.**

### **GLASS CLEANING**

From time to time it will be necessary to clean the glass panel of your Symphony CF fire. We recommend you use a Ceramic hob cleaner these are available for all leading super markets: - i.e.

**ASDA, TESCO, SAINSBURY'S** Etc.

Brands of hob cleaning we have tested and found suitable are - **HOB BRITE & VITRO CLEN.**

- Ensure the fire has been turned OFF for at least four hours to ensure it is cool.
- Remove the glass panel as described below.
- Lay the glass panel down on a flat working surface on top of an old opened newspaper with the side to be cleaned uppermost.
- Follow the instructions on the Hob Cleaner Bottle.
- On stubborn stains (where the appliance has been used for a long period without glass panel being cleaned), use a new Brillo Pad well wetted with the Hob cleaner applied directly to it.
- Ensure all the residues of the cleaner are removed with a damp cloth and the glass panel is completely dry before fitting to the appliance.

**Important:- The appliance must not be used if the glass panel is missing or damaged.**

**Note: - The glass may discolour quickly when first installed, and it should be cleaned. This is due to the burning off process of the refractory shapes.**

# Paragon Quartet Users Instructions

## SECTION THREE Cleaning Continued

### REMOVING GLASS PANEL

- Remove the trim, which is held in position with magnets.
- Lift and remove the inner fascia panel.
- Remove the glass fixing clamp secured with three securing nuts. Take care to support the glass panel when removing the fixing clamp. The glass should be placed in a safe place to prevent damage.
- Once the fuel bed has been laid reassemble in reverse order.

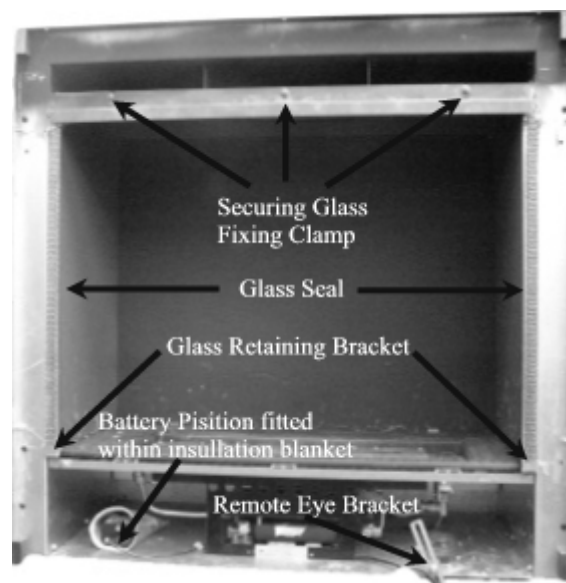

## SECTION FOUR Fuel Bed Cleaning and Layout

- Before you clean any part of the appliance ensures that the appliance is turned off and cold.
- Use only the fuel bed components provided and no additional parts must added.
- Incorrect positioning of the fuel bed components could result in the staining of the glass panel.

**Important:** - Refer to the 'Health & Safety Notice located on page 3 of this booklet before cleaning or replacing any refractory material.

- The fuel bed components are delicate and they should be handled with great care.
- The loose parts and moulded shapes may be removed for cleaning. They can be brushed very gently with a soft brush to remove dust or any deposits.
- A vacuum cleaner may only be used after the loose components and moulded shapes have been removed.
- **Please make sure no loose shapes are placed directly on top of the pilot head. (Please see figure below).**

CARE SHOULD BE TAKEN TO AVOID CONTACT WITH THE REFRACTORY LINING THIS IS A DELICATE SURFACE AND SHOULD **NOT** BE WIPED OR RUBBED.

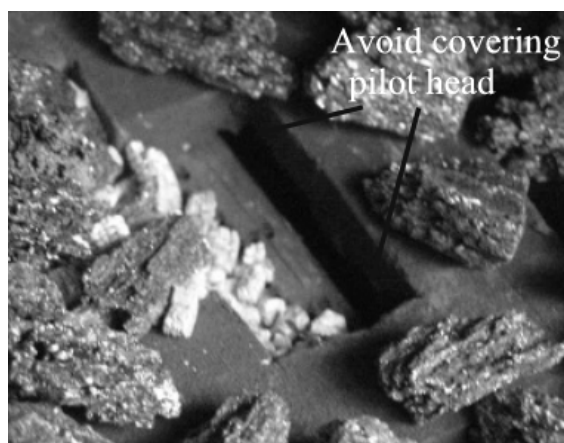



# Paragon Quartet Users Instructions

## SECTION FOUR Fuel Bed Cleaning and Layout Continued

### Fuel Bed Layout (Marble Pebble)

- Locate air tray within the slot on shelf assembly.

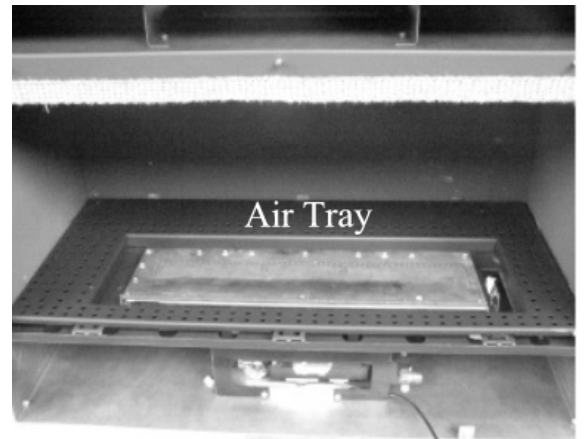

- Place the burner board on top of the burner against the front flange on the burner bar with the pilot cut out on the right hand side.

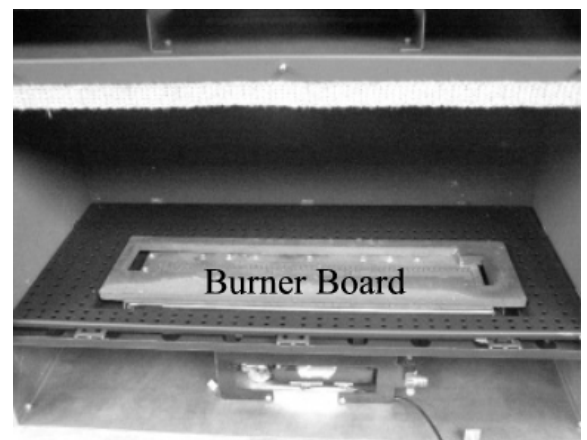

- Place a single layer of pebble on top of the burner board

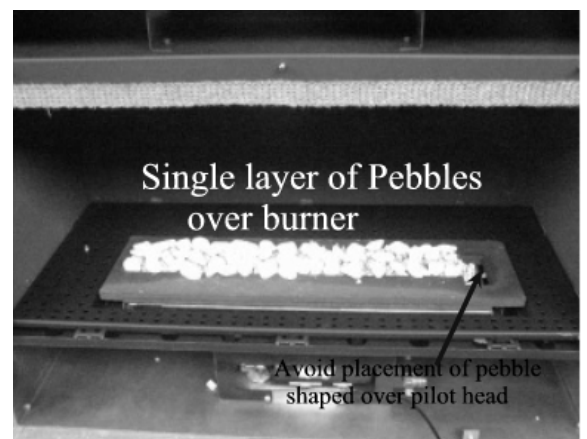

# Paragon Quartet Users Instructions

## SECTION FOUR Fuel Bed Cleaning and Layout Continued

- Place a row of loose pebble making sure the air gap between the burner board and air tray is maintained.

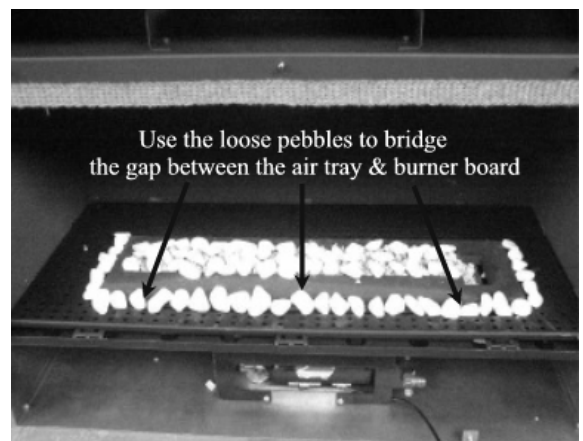

- Place pebbles in the remaining uncovered areas.

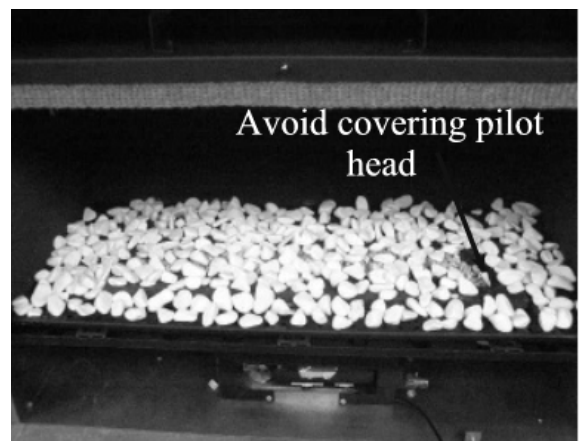

### Fuel Bed Layout (Granite Shapes)

- Position the air tray, burner board and the layer of the vermiculite as described at the start of this section.

- Place a single layer of granite shapes on top of the Burner.



# Paragon Quartet Users Instructions

## SECTION FOUR Fuel Bed Cleaning and Layout Continued

- Place a row of loose granite shapes making sure the air gap between the burner board and air tray is maintained.

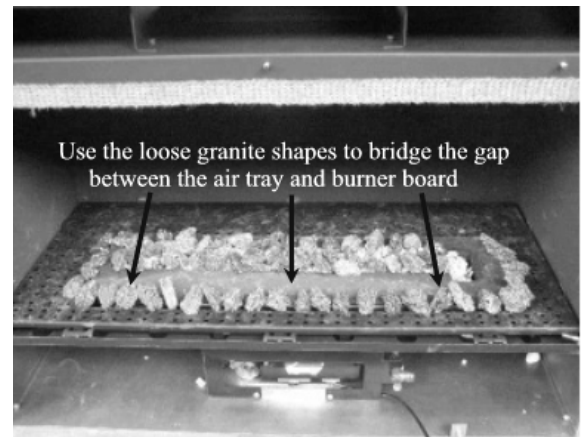

- Place loose granite shapes in the remaining uncovered areas.

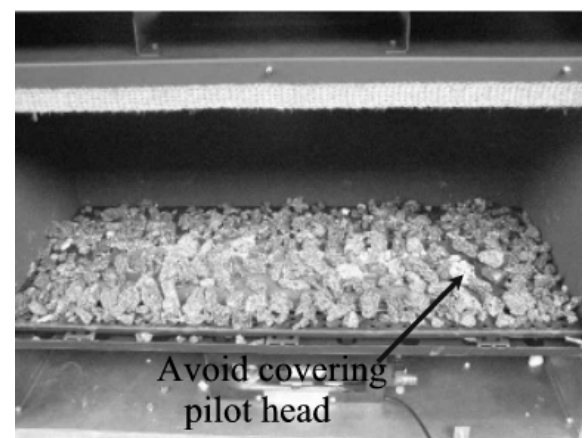

Like all appliances incorporating an aerated burner a low frequency noise may be heard, particularly on the low setting, this is quite normal and does not affect the operation of the appliance.

It is advised that a competent person service the Quartet fire annually. The fire is more likely to provide trouble-free operation.

Dulling and slight discoloration inside the firebox will occur adding to the realism of the appliance. This is normal.

### It is important that: -

- The chimney or flue is checked annually to ensure clearance of combustion products.
- The fire front or fascia must be positioned in front of the fire whilst it is burning
- Any debris from the chimney or flue should be removed. The fire should be allowed to cool before it is removed.
- The fire must not be used if the glass panel is missing or damaged.
- The data badge is located on the LH hand side of the appliance, behind the trim or fascia.

The only user removable parts are: -

- Refractory Fire bed Components
- Fascia
- Fire trim.
- Glass panel.

# Paragon Quartet Installation Instructions

## SECTION SIX Appliance Data

### NATURAL GAS

Gas Type:.....CATEGORY I 2 H  
Gas Pressure:.....20 mbar +/- 1.0mbar  
Pressure Test Point Location:.....Gas inlet elbow  
Gas Input:.....4.2 kW Gross (Max.)  
.....1.5kW Gross (Min.)  
Injectors:.....Mk 290  
Oxy pilot:.....9102  
Gas Connection:.....8mm compression: semi-rigid or rigid  
Data Badge Location:.....Located on the right hand side of the appliance behind the trim and fascia.  
Battery.....Remote handset 9v size MN1604 or 6F22,  
Appliance 6 x 1.5V AA high power alkaline or 6 x 1.5 V Rechargeable nickel metal hydride with a minimum capacity of 2200mAh.  
A special long life lithium battery 7.2 V is available as an optional extra.

## Appliance Dimensions

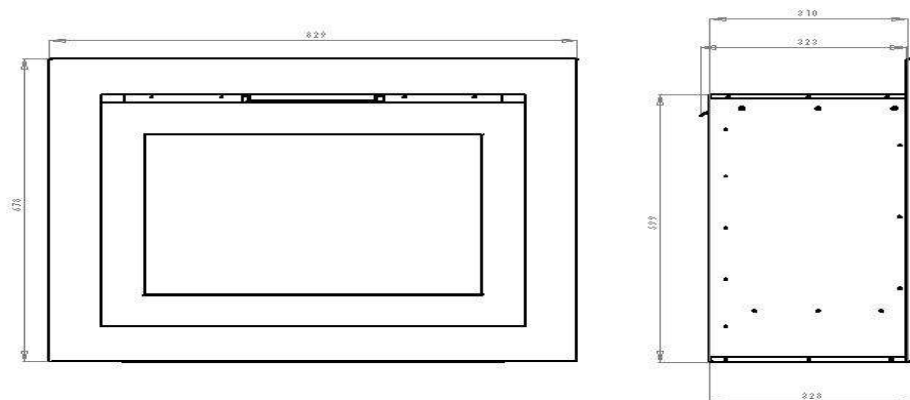

NOTE: The efficiency of this appliance has been measured as specified in BS7977-1 2002 and the result is 80%. The gross calorific value of the fuel has been used for this efficiency calculation. GasTec have certified the test data from which it has been calculated. The efficiency value may be used in the UK Government's Standard Assessment Procedure (SAP) for energy rating of dwellings.

### When unpacking the appliance please check the following items are included:

Fuel Bed:  
Owners Manual,  
Trim  
Fascia.

## SECTION SEVEN Regulations and Warnings

- This appliance must only be installed in Great Britain or Ireland.
- The appliance is suitable for use on natural gas only.
- **GB (Great Britain)** This fire does not normally require purpose build ventilation.
- **IE (Ireland)** Permanent ventilation must comply with the current edition of IS813.
- **In GB, (Great Britain)**

It is the law that all gas appliances must be installed by a competent person; i.e. a CORGI registered installer, in accordance with the Current Gas Safety (Installation And Use) Regulations (as amended), all relevant parts of the local and national building regulations and all relevant recommendations of the following British Standards. Failure to do so could lead to prosecution.

The following are relevant codes of practice and British Standards: -

B.S. 5871

B.S. 5440 PART 1 & PART 2

B.S. 6891

This appliance must be installed to current versions of the above standards and include any relevant amendments to:-

The Building Regulations Issued By The Department Of The Environment.

The Building Standards (Scotland) (Consolidated) Regulations Issued By The Scottish Development Office.

- **IN IE, (Ireland)**

The appliance must be installed by a competent person and installed in accordance with the current edition of I.S.813 Domestic Gas Installation, the current building regulations, and the current ETCI rules for electrical installation, if appropriate.

- Prior to the installation ensure that the local distribution conditions (identification of type of gas and pressure) and adjustment of the appliance are compatible. (G20 @ 20mbar).

### IMPORTANT NOTE: -

**The fire front (fret) or fascia supplied must be used with this appliance.**

## WARNINGS

- The glass front of the fire act as a dress guard, conforming to BS 1945 (1971) and satisfies the heating appliance regulations (1991) However, a guard conforming to BS6539 (1984) must be used to protect young children, the elderly or infirm.
- **This appliance incorporates a safety device in the form of an Oxygen depletion system. IT MUST NOT BE ADJUSTED OR PUT OUT OF OPERATION! THIS IS A NON-SERVICABLE ITEM AND MUST BE EXCHANGED AS A COMPLETE ASSEMBLY; USING ONLY THE ORIGINAL MANUFACTURER'S PART.**
- A non-combustible hearth must be provided to comply with the building regulations, or a suitable proprietary fire surround with a 150°C minimum rating.
- During initial firing, an odour may be evident. This is the starch binder used during the manufacture of the fibre components of the fire, and there are **no harmful** effects produced.
- Care must be taken to prevent any damage being caused to surrounding soft furnishing or decoration; e.g. many embossed vinyl wall coverings may become discoloured if placed too close to the appliance.

# Paragon Quartet Installation Instructions

## SECTION EIGHT Siting the Appliance

### • CLASS ONE

That is a conventional brick or stone chimney as used for a solid fuel appliance with an effective cross-sectional dimension of 225 x 225 mm (9" x 9") or a lined flue with a minimum diameter of 125mm (5"). The chimney must have a minimum effective height of at least 3 metres. Any permanent flue restriction or variable dampers are to be removed or locked fully open. The chimney should be swept prior to installation if it has previously been used with solid fuel. This is not necessary if the flue has previously been used with a gas appliance or if it is a new installation.

**Note:** A brick or stone chimney with a 125 mm (5 ins) minimum diameter flue liner conforming to BS 715 may be used. Provided a suitable sealing plate is fitted to the base of the liner and the appliance does not restrict the opening into the liner. Ensure a smooth lead into the flue way and no combustible materials are used. A void of 50mm must be maintained from the top of the firebox to gather into flue.

### PREPARING THE OPENING

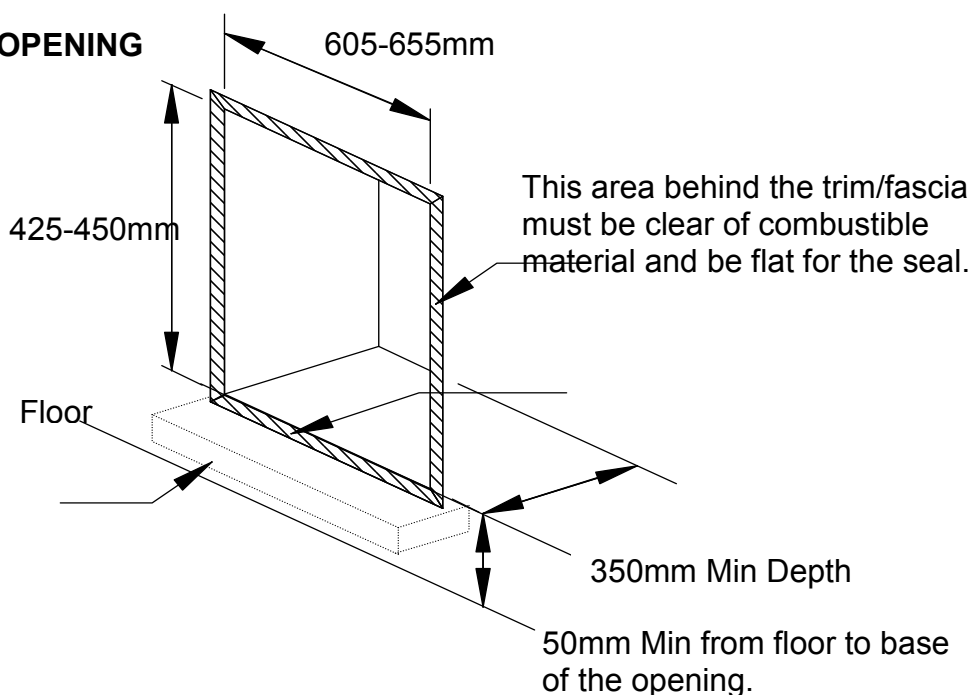

The front face and the base of the fire opening must be flat to ensure that a good seal is formed between the rear and base of the appliance and the chimney to avoid any reduction of natural draught.

Ensure that the air entering the appliance below the lower edge of the decorative trim is not restricted. If the appliance is fitted above a forward projection hearth the base of the opening must be at least 50mm above the hearth. Again, this will ensure that the air entering the appliance below the lower edge of the decorative trim is not restricted.

### CHECKING THE FLUE AND FIRE OPENING

- Check that the chimney conforms to the required specifications as previously stated. Examine the condition and carry out any remedial work including removing any debris from the base.
- If the flue has been used for solid fuel it should be swept prior to the installation
- Prior to installing the appliance a smoke test (using a smoke bomb) should be carried out to check that satisfactory smoke clearance has been established.

If all the smoke is not drawn into the flue, pre-heat the flue with a blowtorch or similar and re-check. If there is any uncertainty examine for the cause and, if necessary, seek expert advice.

**No combustible material should be fitted inside the fireplace opening.**

- When installing this appliance against a dry lined (plasterboard) wall ensure that any void between the plasterboard and the wall is sealed with a suitable non-combustible material (i.e. plaster or mortar).

## SECTION NINE To Install the Appliance Continued

### GAS SUPPLY ROUTING

Use rigid or semi – rigid tube to connect the supply. Determine the gas supply pipe route to the appliance before installing the fire.

### REMOVING GLASS PANEL

- The trim, which is held in position with magnets.
- Lift off the fascia and remove.
- Remove the glass fixing clamp secure with three securing nuts and lift it out of the retaining brackets. Take care to support the glass panel when removing the fixing clamp. The glass should be place in a safe place to prevent damage.
- Once the fuel bed has been laid reassemble in reverse order.

### CONNECTING THE GAS SUPPLY

**Note:** - An isolation valve may be fitted in the gas supply adjacent to inlet pipe.

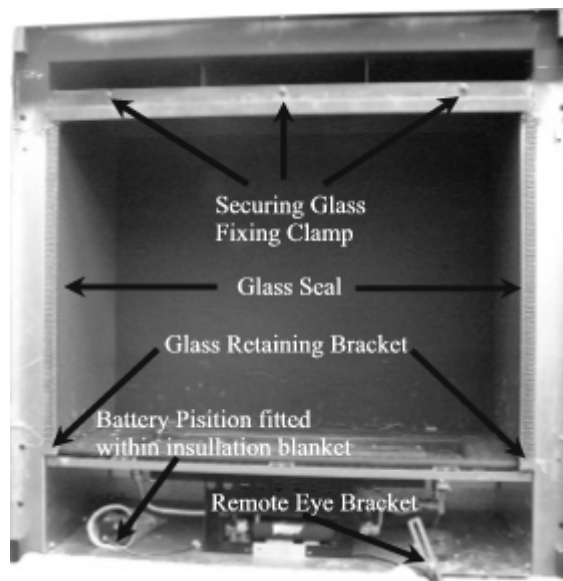

For a concealed connection: -

- Remove the burner assembly by undoing the two fixing screws in front control fascia plus three screws holding the burner tray to carrier.
- Remove the rubber (blind) grommet from the supply pipe inlet hole at the rear of the outer box and slide the box over the supply pipe and fix to the surround using one of the methods described in the next section.
- Refit the grommet over the pipe and seal around the inlet hole.
- Refit the burner unit and make connection between the supply isolating valve and the burner assembly inlet.

### Positioning Remote Control Eye

**Note:** - The remote control eye will need to be attached to the fixing bracket located on the right hand side on the base of the firebox using the self adhesive clip.

- Connect battery pack to appliance and insert batteries.
- Reposition the fascia and trim.
- Fit battery 9V battery (supplied) to remote hand set (see Section 2).
- Check that a signal is being received by pointing the remote control hand set in the direction of the appliance and simultaneously press the buttons marked '●' and 'standby'. Continue to hold in these two buttons until a 'bleep' is heard (approximately 2-3 sec.). If no sound is heard check position of remote control eye.

## SECTION TEN Checking Operation of Fire

### CHECKING GAS SOUNDNESS

- Turn on the gas supply to the appliance and check for soundness in accordance with current codes of practice.
- Turn off the gas supply at the external Isolation valve.
- Remove the pressure test point screw from the inlet elbow and connect the pressure gauge.
- Turn on the gas to the appliance at the Isolation valve.
- Light the appliance as described in section 2.
- Check the inlet pressure is 20mbar. +/- 1.0.
- Turn off gas supply, at the isolation valve. Disconnect the pressure gauge and replace the pressure test point screw.
- Turn on the supply to the appliance and check the pressure test point for soundness with detection fluid.

### LAY FUEL BED

#### Important: -

Refer to the 'Heath & Safety Notice located on page 3 of this booklet before laying or replacing any refractory material.

In the event of replacing fuel bed components please use only the specified number of components as illustrated. Only use fuel bed component provided for this appliance. In the interest of safety and efficiency of your appliance when replacing the fuel bed it is essential that the existing fuel bed be removed and the new components are replaced correctly as a complete set.

Lay fuel bed as described under Users Section.

#### Warning:

It is important that the fuel bed components are positioned as shown in these instructions.

If the fuel bed components are not positioned correctly this may result in damage to the glass.

### REFIT GLASS PANEL

- Refit glass panel. Prior to replacing the glass panel it may necessary to adjust the seal around the glass to ensure it is not seen when the decorative trim or fascia is fitted.

### CHECKING FOR COMBUSTION PRODUCTS CLEARENCE

**IMPORTANT:**-The smoke test must be carried out with the fire starting from cold.

- Light the fire and leave at maximum input.
- Close all the doors and windows.
- After five minutes fit the smoke match in a holder and position as illustrated with the head of the match just inside the test opening.
- Run the match along the top edge **All smoke** must be drawn into the test opening if the clearance is satisfactory.
- If spillage occurs wait a further five minutes and repeat the test.

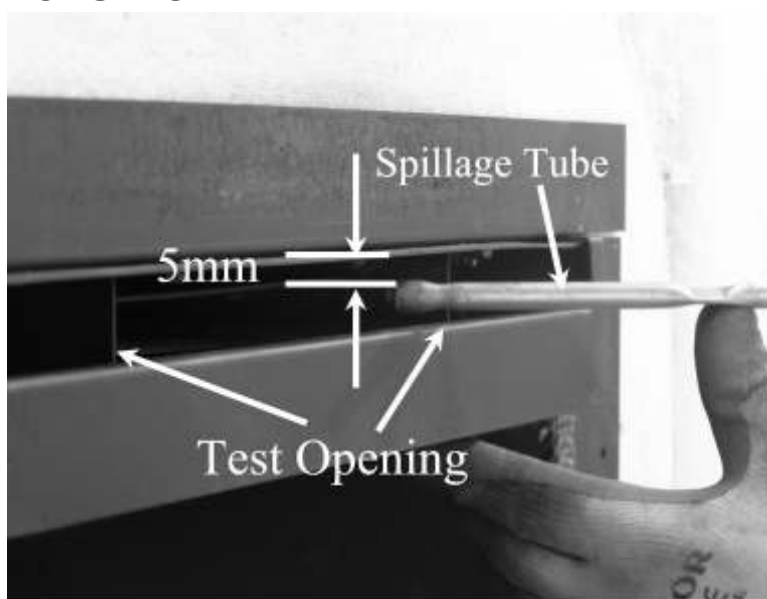



## **SECTION TEN** Checking Operation of Fire

- Repeat the test with doors open and with any extractor fans in other rooms in operation.
- If spillage is detected the cause must be discovered and the fault corrected, if the fault cannot be corrected, disconnect the fire from the gas supply and seek expert advice. Spillage can be caused by a restriction in the flue system, down draught or insufficient ventilation into the room where the fire is installed.

### **FIT STANDARD FIRE TRIM & FASCIA**

- Fit inner fascia panel over the four fixing studs.
- Fit the trim with the magnetic strips placed on the vertical side flange of the box. Avoid placing magnets along the top section of the trim.
- Offer the decorative trim up squarely and centrally and push into position.
- To remove the decorative trim, simply pull away from the magnetic strips.

### **ADVISE CUSTOMER THAT:**

- The glass front of this fire acts as a dress guard, conforming to BS 1945 (1997) and satisfies the heating appliance regulations (1991) however; a fireguard conforming to BS6539 (1997) must be used to protect young children, the elderly, or infirm.
- The curing effect of heating the logs and other refractory components will cause an initial odour. This is due to the starch used in the manufacturing process and is non-toxic.
- Any debris should be cleaned from the appliance. A vacuum cleaner can be used but only after all the loose logs have been removed.
- The appliance should be serviced annually by a competent person in accordance with these instructions and the appliance checked for spillage in accordance with the method detailed in these instructions.
- Demonstrate the lighting and extinguishing procedures to the user and the removal and refitting of the brass trim fret and glass panel for cleaning. Refer to the user section of this booklet.
- If ventilation is fitted for any reason it must be checked regularly to ensure freedom from obstructions.

**Hand these instructions over to the user.**

# **Paragon Quartet Maintenance Instructions**

## **SECTION ELEVEN Maintenance**

### **GENERAL**

- Servicing should be carried out annually by a competent person such as a CORGI-registered person in accordance with the relevant regulations, to ensure the safe and correct operation of the appliance.
- Before commencing any service or replacement of parts, turn off the gas supply to the fire. After servicing check for gas soundness.
- When ordering spare parts please quote appliance name and serial number, these can be found on the data badge, which is located on the right hand side of the appliance behind the trim or fascia.
- At least once a years check for debris in the catchment area behind the fire and in the flue way.
- If soot has accumulated checks to establish cause rectify and clean flue or chimney accordingly.

### **PILOT LINTING**

Check pilot aeration holes for linting, use a vacuum cleaner nozzle taking care not to damage the pilot head.

### **TO REMOVE THE BURNER TRAY**

- Turn off the gas supply by the isolating cock.
- Remove the trim, fascia and glass panel.
- Remove the loose fuel bed components.
- Disconnect battery leads and remove appliance battery pack.
- Detach remote control eye from the fixing bracket. (See Section Nine when repositioning.)
- Disconnect fire at inlet elbow and Undo the five burner tray fixing screws. Pull carefully forward and remove.
- For normal servicing the tray can be cleaned using a vacuum cleaner.
- Whilst the tray is removed vacuum the firebox if necessary.

### **REPLACEMENT OF GAS CONTROL**

- Follow the burner tray removal sequence.
- Disconnect the thermocouple from the rear of the gas valve.
- Undo the three compression nuts securing the pipes to the gas valve and remove the two screws fixing the valve to the bracket.
- Clean, service or replace gas valve.
- Re-assemble in the reverse order.
- Turn on the gas supply, check for soundness and re-commission appliance.

### **REPLACEMENT OF INJECTOR**

- Follow the burner tray removal sequence.
- Undo the compression nut on the supply pipe.
- Unscrew the locking nut holding the injector on the chassis.
- Clean or replace the injector.

NOTE: -Do not use a wire or a drill to clean out holes. Refer to the appliance data section for details.

- Re-assemble in reverse order.

# Paragon Quartet Maintenance Instructions

## SECTION ELEVEN Maintenance Continued

### REPLACEMENT OF OXY-PILOT ASSEMBLY

**NOTE:** If the pilot assembly is replaced it must be replaced by an identical unit from the same manufacturer and replaced as a complete unit.

- Follow the burner tray removal sequence.
- Undo the compression nut on the supply pipe at the pilot.
- Carefully pull off the ignition lead.
- Disconnect the thermocouple at the end of the main control valve.
- Remove the cross headed nut holding the pilot to the chassis
- Carefully remove the pilot shield & oxy-pilot.
- Re-assemble in reverse order.

### REPLACEMENT OF CONTROL UNIT (EDB)

- Follow the burner tray removal sequence.
- Disconnect leads from control unit and remove 4 bolts.
- Re-assemble in the reverse order.

Turn on the gas supply, check for gas soundness and re-commission appliance.

### FLUE CHECK

- Remove the fire from the opening: - Reversing fitting instructions, but first remove fascia, trim, glass panel and Log shapes.
- Examine flue and rectify as necessary.
- Replace the fire, referring to fitting instructions.

## SECTION TWELVENE Wiring Diagram

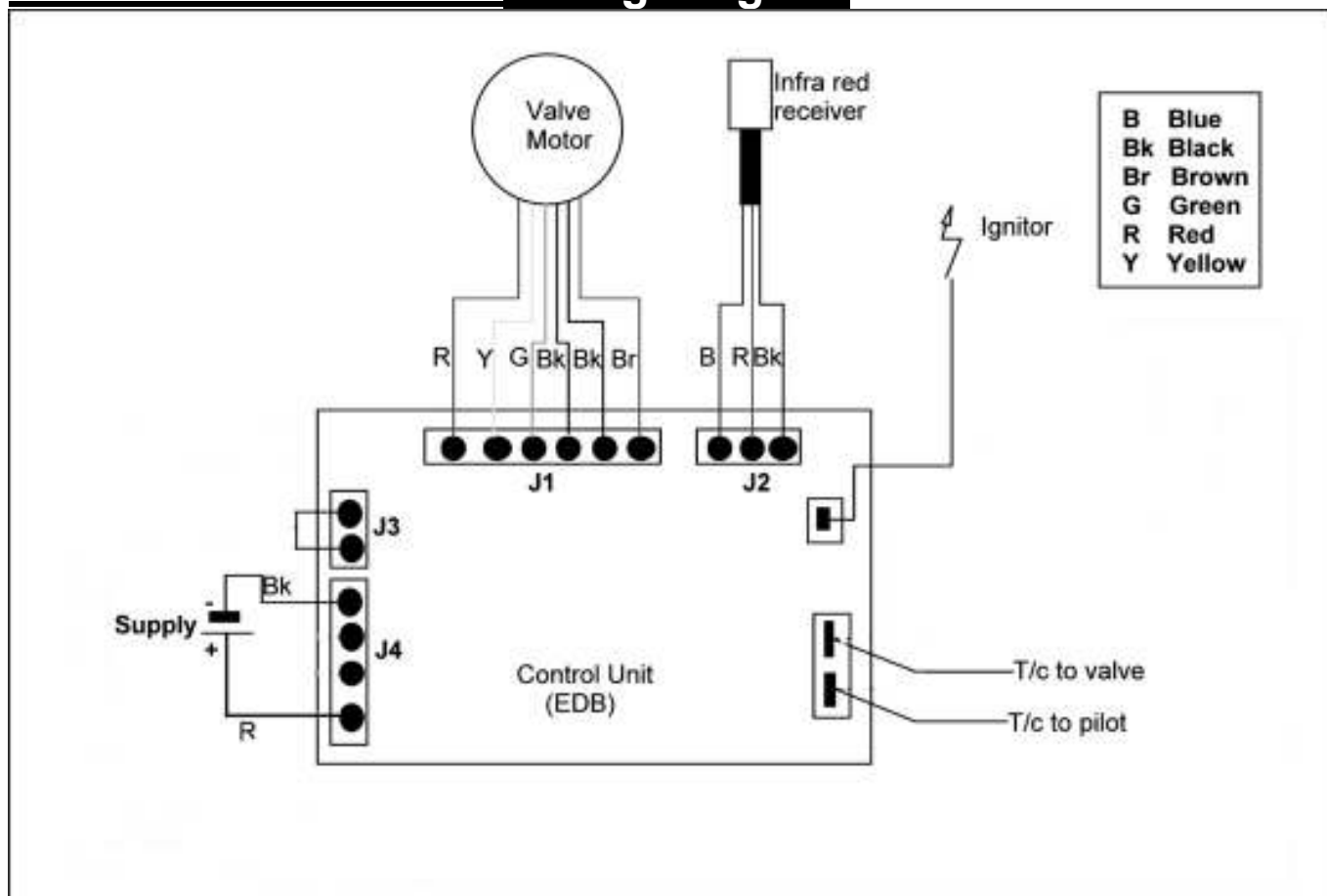

**PARAGON QUARTET**

**THIS IS YOUR EXTENDED THREE YEAR PARTS**

**WARRANTY**

**PLEASE READ IT CAREFULLY AND ENSURE YOUR INSTALLER HAS FILLED IN THE FIRST PORTION, KEEP IT IN A SAFE PLACE SO THAT IT IS AVAILABLE WHEN YOUR CORGI ENGINEER CARRIES OUT THE ANNUAL SERVICE.**

**THIS IN NO WAY REDUCES YOUR STATUTORY RIGHTS**

**THE WARRANTY COMMENCES FROM THE DATE OF PURCHASE YOU MUST RETAIN YOUR RECEIPT OR INVOICE AS PROOF OF PURCHASE.**

**THIS EXTENDED WARRANTY SPECIFICALLY EXCLUDES SOFT REFRACTORY COMPONENTS, THE BULB AND ANY BATTERIES.**

Terms and Conditions

1. The appliance must be installed by a CORGI registered person.
2. The appliance must be used in accordance with the users instructions.
3. The appliance must be serviced annually by a CORGI registered person.
4. The service log must be correctly filled out and the record of annual services must be up to date and supported by receipts in each case.
5. This warranty is not transferable and relates to the original installation only.
6. The Registration Form must be correctly filled out and returned.
7. The appliance has not been subjected to misuse or accident or been modified or repaired by any person other than the authorised employee or authorised representative of Charlton and Jenrick Ltd.
8. The registration form must be returned within 3 months of purchase.

**PARAGON HELPDESK NUMBER 01952 278 020**

# WARRANTY COVER

## Important

For future reference we suggest you record the following details here, and keep the receipt as proof of purchase. This information may be asked for when you contact the helpdesk.

**Model:** **PARAGON QUARTET**      **Serial No.**     

This information can be found on the label attached to the packaging and on the data badge, which is located on the appliance flange, top right behind trim.

**Retailer Name:** \_\_\_\_\_

**Address:** \_\_\_\_\_

\_\_\_\_\_

\_\_\_\_\_

**Date of Purchase:**     

## Service Log

The following information must be complete and supported by receipts as part of the conditions of the extended three year parts warranty and the appliance must be registered by completing and returning the registration document (last page of this booklet) to Paragon Fires.

Date of First annual service:     

Engineer Name      \_\_\_\_\_

Corgi Registration No.     

Date of Second annual service:     

Engineer Name      \_\_\_\_\_

Corgi Registration No.     

We may introduce modifications to products from time to time, and consequently the details given in this booklet are subject to alteration without notice.

## ***Paragon Fires***

Telford  
Shropshire  
TF7 4QJ

Telephone 01952 278 020

Web Site [www.paragonfires.co.uk](http://www.paragonfires.co.uk)

**PLEASE REGISTER YOUR 12 MONTH WARRANTY WITH US TODAY**

Simply detach this sheet from this booklet, complete and return it in a stamped addressed envelope to:

**PARAGON FIRES**

Charlton and Jenrick Ltd  
UNIT G1 – G3  
HALESFIELD 5  
TELFORD  
SHROPSHIRE  
TF7 4QJ

**YOUR DETAILS**

**Name** \_\_\_\_\_

**Address** \_\_\_\_\_

\_\_\_\_\_

\_\_\_\_\_

**Post Code**

**TELEPHONE No.**

**PRODUCT DETAILS**

**Model:** : **PARAGON QUARTET** **Serial No.**

**Date of Purchase**

This information can be found on the label attached to the packaging and on the data badge, which is located on the appliance flange, top right behind trim.

**WHERE DID YOU PURCHASE THIS PRODUCT**

**Name** \_\_\_\_\_

**Address** \_\_\_\_\_

\_\_\_\_\_

\_\_\_\_\_

**Post Code**

**TELEPHONE No.**



**Paragon Quartet**

<b>Product ID Label</b>	<b>A-0110</b>	<b>Serial No Prefix</b>	<b>KF</b>
Burner Tray / Box Assembly			
Restrictor Elbow (2613)			
Linings (Side, rear and top)			
Bag Of Paragonite Black (2Kg) Part No 5292			
Bag Of White Marble Stones (Part No 5244)			
Air Tray (Part No 5183)			
Ceramic Burner Board			
Glass Panel			
Quartet Inner Fascia (5231)			
Quartet Trim (5233)			
Silicone Sealing Strip (4818)			
Battery (9V PP3)			
Remote Control Hand Set			
Battery Holder			
Battery Insulation Blanket			
AA Battery (12)			
Magnet (4 X Segment 3048)			
Owners Book			
Data Badge NG (Located behind trim)			
Warning Label (1409)			
ID Label & Packing Labels			
Grommet (1092)			
Serial Number			
Inspector			