

# **FOCUS HE SLIMLINE SC**

## **OWNER'S MANUAL**

**Please read these instructions carefully before you start  
using the appliance**

**Keep this booklet handy for future reference**

**This appliance is  
for use in Great Britain or  
IRELAND only**

**This appliance is  
for use in GREAT BRITAIN or IRELAND only**

**A QUALITY PRODUCT FROM PARAGON FIRES**

**CONTENTS**

**PAGE**

**USERS INSTRUCTIONS**

<b>SECTION ONE Introduction</b> .....	<b>3</b>
<b>SECTION TWO Operating Appliance</b> .....	<b>4</b>
<b>SECTION THREE Fuel Bed Cleaning and Layout</b> .....	<b>5</b>
<b>SECTION FOUR Cleaning</b> .....	<b>8</b>
<b>SECTION FIVE General Points</b> .....	<b>9</b>

**INSTALLATION INSTRUCTIONS**

<b>SECTION SIX Appliance Data</b> .....	<b>10</b>
<b>SECTION SEVEN Regulations and Warnings</b> .....	<b>10</b>
<b>SECTION EIGHT Siting the Appliance</b> .....	<b>13</b>
<b>SECTION NINE To Install Appliance</b> .....	<b>14</b>
<b>SECTION TEN Checking Fire Operation</b> .....	<b>17</b>
<b>SECTION ELEVEN Maintenance</b> .....	<b>18</b>

## SECTION ONE Important Information

### Consumer Protection Information

As manufacturers and suppliers of heating products, we take every care, as far as is reasonably practicable, that these products are so designed and constructed as to meet the general safety requirement when properly used and installed. To this end, our products are thoroughly tested and examined before despatch.

**IMPORTANT NOTICE:** Any alteration that is not approved by the appliance manufacturer could invalidate the approval of the appliance, operation of the warranty and could affect your statutory rights.

### Health and Safety Notice

#### **Important**

This appliance could contain some of the materials, indicated below, that could be interpreted as being injurious to health and safety. It is the users / installers responsibility to ensure that the necessary personal protective clothing is worn when handling these materials, see below for information.

**Artificial Fuels, Mineral Wool, Insulation Material, Refractory/Ceramic Fibres, Glass Yarn** - *may be harmful if inhaled, may be irritating to skin, eyes, nose and throat.*

**When handling** *avoid inhaling and contact with skin or eyes. Use disposable gloves, facemasks and eye protection. After handling wash hands and other exposed parts. If a vacuum is used for cleaning the coals or cleaning after servicing / installation it is recommended that it be of the type fitted with a HEPA filter.*

**Disposal of refractory/ceramic materials.** To keep dust to a minimum these materials should be securely wrapped in polythene and be clearly labelled 'RCF waste'. These materials are not classified as 'hazardous waste' and should be disposed of at a site licensed for the disposal of industrial waste.

- The FOCUS HE SLIMLINE SC is a decorative fuel effect appliance with a radiant heat conserver box and glass panel for improved efficiency.
- The FOCUS HE SLIMLINE SC incorporates a single gas control, which selects ignition pilot, and variable settings between Low and High.
- This appliance is intended for decorative purposes.
- The FOCUS HE SLIMLINE SC appliance is designed and tested to the requirements of the EN 509.
- The appliance is for use on Natural Gas only.
- The chimney or flue (unless new or previously used with a gas appliance) must be swept before installation if it has been used for solid fuel.

### **WARNING**

The glass front of this fire acts as a dress guard, conforming to BS 1945 (1997) however; a fireguard conforming to BS6539 (1997) must be used to protect young children, the elderly or infirm. Clothing or other combustible materials must not obstruct the slots at the top of the fire or the base of the appliance.

### **SOFT FURNISHINGS**

Care must be taken to prevent any damage being caused to surrounding soft furnishing or decoration; e.g. many embossed vinyl wall coverings may become discoloured if placed too close to the appliance. Combustible material i.e. wall panelling or wallpaper must be removed from behind the fire and fire trim.

## SECTION ONE Important Information Continued

### INTRODUCTION

- The FOCUS HE SLIMLINE SLIDE CONTROL incorporates a single gas control, which selects ignition pilot, and main burner low and high settings.
- The appliance incorporates a safety device in the form of an Oxygen Depletion System, which constantly monitors the oxygen in the room and will cause the fire to switch off if the oxygen level reduces, for instance due to insufficient ventilation or a blocked flue. If this regularly occurs do not attempt to relight the appliance until a qualified engineer has checked it, the problem may not be due to lack of air or a defective flue.
- A fire front (fret) must be used with this appliance.
- In GB, the appliance must be installed by a competent person i.e. CORGI-registered, in accordance with the GAS SAFETY (INSTALLATION AND USE) REGULATIONS, The Building Regulations (or The Building Regulations (Scotland) or The Building Regulations (Northern Ireland)) and The Current I.E.E. Wiring Regulations, if appropriate.
- In IE, the appliance must be installed by a competent person and installed in accordance with the current edition of I.S.813 Domestic Gas Installation, the current Building Regulations and the current ETCl rules for electrical installation, if appropriate.
- The pilot can be left on or the pilot can be extinguished and relit each time the fire is used.
- During the normal operation of the fire some black staining may appear on some parts of the fuel bed. This is quite normal and adds to the appearance of the appliance. However, if excessive black staining does occur it may be due to the fuel bed being incorrectly laid. This should be checked prior to contacting a service engineer.

## SECTION TWO Operation

- **Do not use the fire with the glass safety screen removed, or if the glass is cracked.**
- **Do not use the fire with the canopy removed.**
- The pilot can be left on or the pilot can be extinguished and relit each time the fire is used.

### The full lighting procedure is as follows: -

- a. Push slide control lever down, as far as possible a clicking noise will be heard and pilot will light, **HOLD DOWN FIRMLY FOR ABOUT 20 SECONDS.**
- b. Allow the lever to spring up the pilot light should remain alight and the main burner should light on its low setting.
- c. Should the pilot fail to light, pull the lever fully up to turn off the appliance, wait 3 minutes, and repeat the procedure (a & b). If the pilot does not light and no clicking noise is heard replace the battery and try again.
- d. After lighting the pilot flame and the main burner on its low setting the control lever may be lifted until slight resistance is felt, this will put the burner on its high setting.
- e. To completely extinguish the fire, pull the lever up past the resistance to its fullest extent. The fire may be operated on either its low or high setting.
- f. It is recommended that the appliance be operated on its high setting for a short period before adjusting to the low setting.
- g. If the ignition does not operate fit a new 9V battery (PP3/MN1602) to the ignition unit, located behind the fret adjacent to the gas inlet pipe, and repeat ignition procedure prior to reporting a fault.

**Note:** - If the ignition fails the pilot can be lit with a taper or a match held at the pilot head.

Remove fret for access and replace after lighting.

If the fire is extinguished for any reason wait 3 minutes before relighting.

## SECTION THREE Fuel Bed Cleaning and Layout

**Warning:** - Before you clean any part of the appliance ensures that the appliance is turned off and cold.

**Important:** - *Refer to the 'Health & Safety Notice located on page 3 of this booklet before cleaning or replacing any refractory material.*

The fuel bed components are delicate and they should be handled with great care. The loose parts and moulded shapes may be removed for cleaning. They can be brushed very gently with a soft brush to remove dust or any deposits. A vacuum cleaner may only be used after the loose components and moulded shapes have been removed.

CARE SHOULD BE TAKEN TO AVOID CONTACT WITH THE REFRACTORY LINING THIS IS A DELICATE SURFACE AND SHOULD **NOT** BE WIPED OR RUBBED.

### REMOVING GLASS PANEL

- Remove the trim, which is held in position with magnets.
- Remove the fret and ash pan cover.
- Lift of the canopy and remove.
- Remove the glass fixing clamp secure with three securing nuts and lift it out of the retaining brackets. Take care to support the glass panel when removing the fixing clamp. The glass should be place in a safe place to prevent damage.
- Once the fuel bed has been laid reassemble in reverse order.

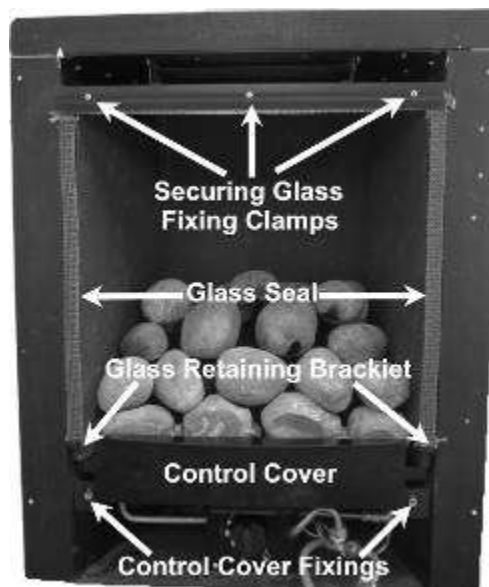

## SECTION THREE Fuel Bed Cleaning and Layout

- 6 OFF "A" Coal Shapes
- 9 OFF "B" Coal Shapes



### FUEL BED LAYOUT (COAL OPTION)

- Ensure the REAR MATRIX is in position as shown located against the rear edge of the burner outlet.



- Locate the front Matrix as shown.



## SECTION THREE Fuel Bed Cleaning and Layout Continued

- Locate the first row of coals within the location points in the front matrix.



- Lay a second layer of coals as shown.

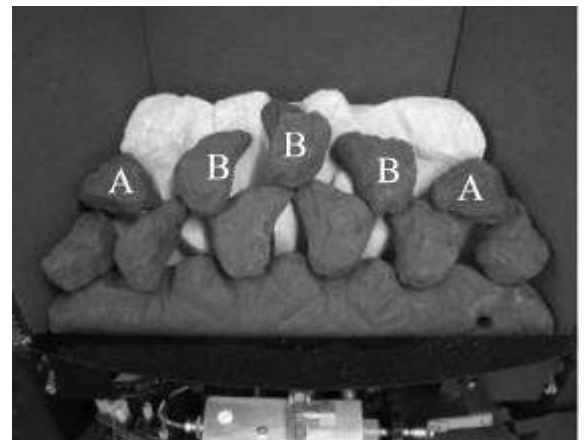

- Lay the third layer of coals so that they bridge across the first and second rows.
- Refit glass panel, heat shield, canopy, trim and fret.



**Note: The appliance MUST no be used if the canopy or glass panel is missing or damaged.**

6 OFF "D" Pebble Shapes  
9 OFF "B" Pebble Shapes

### **FUEL BED LAYOUT** **(PEBBLE OPTION)**



- Ensure the REAR MATRIX is in position as shown located against the rear edge of the burner outlet.

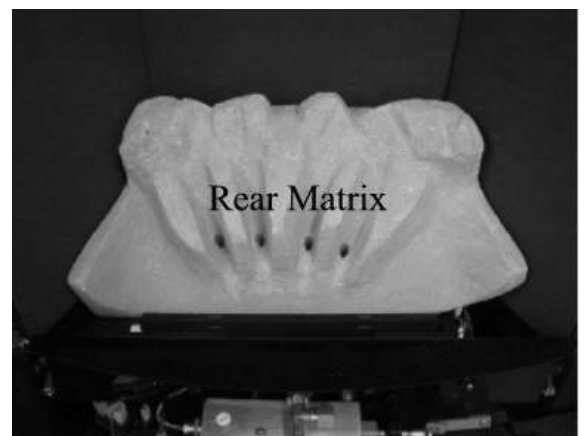

## SECTION THREE Fuel Bed Cleaning and Layout Continued

- Locate the Front Matrix as shown.



- Locate the first row of Pebbles within the location points in the front matrix.



- Lay a second layer of Pebbles as shown.



- Lay the third layer of Pebbles as shown.





# **FOCUS HE SLIMLINE SC Users Instructions**

## **SECTION FOUR Cleaning**

### **CLEANING: BRASS**

The brass fret and brass effect fire surround trim may be cleaned with a clean damp cloth.

N.B The trim and fire front should be removed for cleaning. (The trim is held in place by magnetic strips.)

### **CLEANING: BLACK PAINTED SURFACES**

- These surfaces should be dusted regularly and any marks removed with a soft cloth.
- Abrasive or chemical cleaner should **never** be used for cleaning these surfaces.

•

### **GLASS CLEANING**

**Note: - The glass may discolour quickly when first installed, and it should be cleaned. This is due to the burning off process of the refractory shapes.**

From time to time it will be necessary to clean the glass panel. We recommend you use a Ceramic hob cleaner these are available for all leading supermarkets: - i.e. **ASDA, TESCO, SAINSBURY'S** Etc.

Brands of hob cleaning we have tested and found suitable are - **HOB BRITE & VITRO CLEN.**

**Ensure that the appliance is cold before cleaning the glass.**

**To remove glass panel for cleaning:**

- Remove trim, which is held in position with magnets.
- Remove the fret and ash pan cover.
- Lift of the canopy and remove the refractory heat shield located in front of the glass panel.
- Remove the glass fixing clamp secure with two wing nuts and lift it out of the retaining brackets. Take care to support the glass panel when removing the fixing clamp.
- Lay the glass panel down on a flat working surface on top of an old opened newspaper with the side to be cleaned uppermost.
- Follow the instructions on the Hob Cleaner Bottle.
- On stubborn stains (where the appliance as been used for a long period without glass panel being cleaned), use a new Brillo Pad well wetted with the Hob cleaner applied directly to it.
- Ensure all the residues of the cleaner are removed with a damp cloth and the glass panel is completely dry before fitting to the appliance.
- Check that the coals are correctly placed before reassembling in reverse order.

**Note: The appliance MUST no be used if the canopy or glass panel is missing or damaged.**

## SECTION FOUR Cleaning Continued

### CLEANING: PILOT ASSEMBLY

**Pilot Cleaning** (Before cleaning ensure that the appliance is turned off and cold)

In some instances you may experience ignition problems even when the appliance is new. This may be due to the aeration hole in the pilot body (see photograph) being partial blocked with dust, pet hairs or other foreign matter. The source of this debris could be such things as carpet fibres, decorating or pet etc.

To clean the pilot, remove the fire front and ashpan. The pilot is located on the right hand side of the appliance, any debris in or around the aeration hole should be removed using the nozzle of a vacuum cleaner. It is advisable not to blow the debris into the hole as this may cause more of a restriction and not rectify the problem.

**Note:** - Take care when cleaning in this area so as not to damage the pilot assembly.

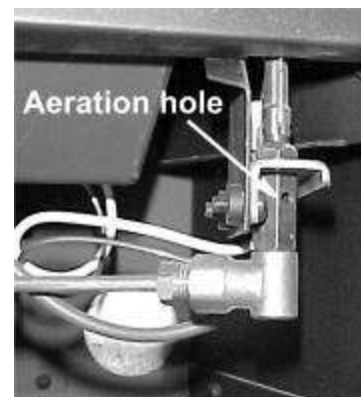

## SECTION FIVE General Points

Like all appliances incorporating an aerated burner a low frequency noise may be heard.

It is advised that the FOCUS SLIMLINE SLIDE CONTROL fire be serviced annually by a competent person. The fire is more likely to provide trouble-free operation. The actions given below should be carried out during that service.

Dulling and slight discoloration inside the firebox will occur adding to the realism of the appliance, this is quite normal.

It is important that: -

- The chimney or flue is checked annually to ensure clearance of combustion products.
- The fire front must be positioned in front of the fire whilst it is burning
- Any debris from the chimney or flue should be removed. The fire should be allowed to cool before it is removed.
- The fire must not be used if the glass panel is not fitted or damaged - this includes the seal.
- The fire must not be used if the canopy is not fitted.
- The data badge is located behind the fret on the right hand side of the appliance.

The only user removable parts are: -

- Fret
- Refractory Fire bed Components
- Canopy.
- Trim.
- Glass panel.

# FOCUS HE SLIMLINE SC Installation Instructions

## SECTION SIX Appliance

### Data

Category of Appliance.....B<sub>AS</sub>

Category.....I<sub>2H</sub>

Gas Type.....G20

Gas Pressure: 20 mbar +/- 1.0mbar

Gas Input (Gross).....4.2 kW (Max.)

2.40 kW (Min)

Injectors:.....Size 290

Oxy-pilot.....9044NG

Data Badge Location: (Behind fret) right hand side of the appliance.

Gas Connection:.....8mm OD tube.

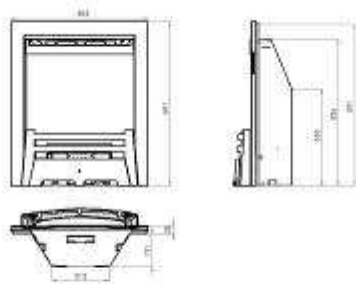

NOTE: The efficiency of this appliance has been measured as specified in BS7977-1 2002 and the result is 68%. The gross calorific value of the fuel has been used for this efficiency calculation. GasTec have certified the test data from which it has been calculated. The efficiency value may be used in the UK Government's Standard Assessment Procedure (SAP) for energy rating of dwellings.

## PACK CONTENTS

When unpacking the appliance please check the following items are included: Appliance (10.5kg)

- Owners Manual
- Wire fixing kit
- Foam seal
- Trim (1.5kg)
- Fret and ashpan cover (4kg Max)
- Refractory Fuel Bed Components (Rear Matrix Front Matrix and Loose Coals.

## SECTION SEVEN Regulations and Warnings

### Consumer Protection Information

As manufacturers and suppliers of heating products, we take every care, as far as is reasonably practicable, that these products are so designed and constructed as to meet the general safety requirement when properly used and installed. To this end, our products are thoroughly tested and examined before despatch.

**IMPORTANT NOTICE:** Any alteration that is not approved by the appliance manufacturer could invalidate the approval of the appliance, operation of the warranty and could affect your statutory rights.

## **SECTION SEVEN Regulations and Warnings Continued**

### **Health and Safety Notice**

#### **Important**

This appliance could contain some of the materials, indicated below, that could be interpreted as being injurious to health and safety. It is the users / installers responsibility to ensure that the necessary personal protective clothing is worn when handling these materials, see below for information.

**Artificial Fuels, Mineral Wool, Insulation Material, Refractory/Ceramic Fibres, Glass Yarn - may be harmful if inhaled, may be irritating to skin, eyes, nose and throat.**

**When handling** *avoid inhaling and contact with skin or eyes. Use disposable gloves, facemasks and eye protection. After handling wash hands and other exposed parts. If a vacuum is used for cleaning the coals or cleaning after servicing / installation it is recommended that it be of the type fitted with a HEPA filter.*

**Disposal of refractory/ceramic materials.** To keep dust to a minimum these materials should be securely wrapped in polythene and be clearly labelled 'RCF waste'. These materials are not classified as 'hazardous wa' and should be disposed of at a site licensed for the disposal of industrial waste.

### ***MANUAL HANDLING GUIDANCE***

Do not handle appliance unless: -

- **You have received up to date manual handling training.**
- **Your supervision / leadership is adequate.**

When handling: -

- **One fully fit person should be able to lift this appliance. If you consider this weight to be excessive then you must obtain assistance.**
- **Gloves and safety shoes must be worn.**
- **Use hand holes provided in the carton.**
- **Bend using legs keeping back straight.**
- **Reposition feet rather than twisting at waist.**
- **Do not lean forwards or sideways.**
- **Always grip with palm of hand and not fingertips.**

Unpacking the appliance:-

1. **Cut tape located at top of box and open box.**
2. **Remove loose items located in side retainers.**
3. **Remove cardboard side retainers.**
4. **Remove fire assembly**

**Packaging should be disposed off in line with your companies environmental / recycling procedure.**

- **THIS APPLIANCE MUST ONLY BE INSTALLED IN Great Britain OR IRELAND.**
- **THE APPLIANCE IS SUITABLE FOR USE ON NATURAL GAS ONLY.**
- **THE APPLIANCE IS INTENDED FOR DECORATIVE PURPOSES.**
- **(GB) NO SPECIAL VENTILATION BRICKS OR VENTS ARE REQUIRED INTO THE ROOM CONTAINING THE APPLIANCE, PROVIDING NORMAL ADVENTITIOUS ROOM VENTILATION EXISTS. THE INSTALLER MUST SATISFY THIS POINT BY CARRYING OUT THE MANDATORY SPILLAGE TEST.**

## SECTION SEVEN Regulations and Warnings Continued

- (IE) PERMANENT VENTILATION MUST COMPLY WITH THE CURRENT EDITION OF IS813.
- In GB. IT IS THE LAW THAT ALL GAS APPLIANCES MUST BE INSTALLED BY A COMPETENT PERSON; I.E. A CORGI REGISTERED INSTALLER, IN ACCORDANCE WITH THE CURRENT GAS SAFETY (INSTALLATION AND USE) REGULATIONS (AS AMENDED), ALL RELEVANT PARTS OF THE LOCAL AND NATIONAL BUILDING REGULATIONS AND ALL RELEVANT RECOMMENDATIONS OF THE FOLLOWING BRITISH STANDARDS. FAILURE TO DO SO COULD LEAD TO PROSECUTION.

- **IMPORTANT NOTE:-** The fire front (fret) supplied must be used with this appliance.

THE FOLLOWING ARE RELEVANT CODES OF PRACTICE AND BRITISH STANDARDS: -

BS 5871    BS 8303    BS 5440 PART 1    BS 1251    BS 6891  
BS 6461 PARTS 1 AND 2    BS 715    BS 1289 PART 1

Note: - This appliance must be installed to current versions of the above standards and include any relevant amendments.

THE BUILDING REGULATIONS ISSUED BY THE DEPARTMENT OF THE ENVIRONMENT.  
THE BUILDING STANDARDS (SCOTLAND) (CONSOLIDATED) REGULATIONS ISSUED BY THE SCOTTISH DEVELOPMENT OFFICE.

*IN IE, THE APPLIANCE MUST BE INSTALLED BY A COMPETENT PERSON AND INSTALLED IN ACCORDANCE WITH THE CURRENT EDITION OF I.S.813 DOMESTIC GAS INSTALLATION, THE CURRENT BUILDING REGULATIONS AND THE CURRENT ETCI RULES FOR ELECTRICAL INSTALLATION, IF APPROPRIATE.*

**PRIOR TO THE INSTALLATION ENSURE THAT THE LOCAL DISTRIBUTION CONDITIONS (IDENTIFICATION OF TYPE OF GAS AND PRESSURE) AND ADJUSTMENT OF THE APPLIANCE ARE COMPATIBLE. (G20 @ 20mbar)**

### WARNINGS

- The glass front of the fire act as a dress guard, conforming to BS 1945 (1971) and satisfies the heating appliance regulations (1991) However, a guard conforming to BS6539 (1984) must be used to protect young children, the elderly or infirm.
- **This appliance incorporates a safety device in the form of an Oxygen depletion system. IT MUST NOT BE ADJUSTED OR PUT OUT OF OPERATION! THIS IS A NON SERVICABLE ITEM AND MUST BE EXCHANGED AS A COMPLETE ASSEMBLY; USING ONLY THE ORIGINAL MANUFACTURER'S PART.**
- A non-combustible hearth must be provided to comply with the building regulations, or a suitable proprietary fire surround with a 150°C minimum rating. See Section 8.
- During initial firing, an odour may be evident. This is the starch binder used during the manufacture of the fibre components of the fire, and there are **no harmful** effects produced.
- Care must be taken to prevent any damage being caused to surrounding soft furnishing or decoration; e.g. many embossed vinyl wall coverings may become discoloured if placed too close to the appliance.

# **FOCUS HE SLIMLINE SC Installation Instructions**

## **SECTION EIGHT Siting the Appliance**

The fire can be installed in the following locations: -

### **CLASS ONE & CLASS TWO & PRE-CAST**

A conventional brick or stone chimney as used for a solid fuel appliance with an effective cross-sectional dimension of 225 x 225 mm (9 x 9 INS) or a clay/ceramic/metal lined flue with a minimum diameter of 125mm (5 INS). A prefabricated gas flue system with a minimum diameter of 125mm (5 INS). The chimney should be swept prior to installation if previously used with solid fuel or oil appliances. It is not necessary if the flue is new or previously used with a gas appliance. The chimney to have a minimum effective height of at least 3 metres. Any permanent flue restriction or variable dampers are to be removed or locked fully open.

A pre-cast flue correctly constructed conforming to the requirements of BS 1289: 1975, 1986 or 1989 with a minimum effective overall height of 3 metres (10 ft) which is correctly terminated (see BS 5440). It will normally require an additional thickness of 25mm in the form of a fireplace back panel or if it is intended to be fitted back to the plaster line then a spacer may be required to meet with the minimum depth requirement.

**IMPORTANT:** - *The flue restrictor is made up of 3 snap-off plates and needs to be removed for 5" and pre-cast flues*

Note: An inspection should be made to ensure that the internal walls of the flue are clear of mortar fangs. It is recommended that the plasterwork should not be directly bonded to the surface of the flue blocks, ensuring that there is a small air gap between the flue blocks and the wall surface. The fire can be installed with the plasterwork being directly bonded to the flue blocks but there is a risk of surface cracking occurring to the plaster above the appliance.

### **INSTALLATION REQUIREMENTS INTO THE FIREPLACE**

The front face and the base of the fire opening must be flat to ensure that a good seal is formed between the rear and base of the appliance and the chimney to avoid any reduction of natural draught. A minimum depth of 170 mm is required into the fireplace if the chimney has previously been used with solid fuel or oil appliances. A minimum depth of 140 mm is required into the fireplace if the chimney is new or has only been used with gas fires previously. If insufficient depth is found, spacer frames can be obtained from the manufacturer to increase installation depth (see diagram).

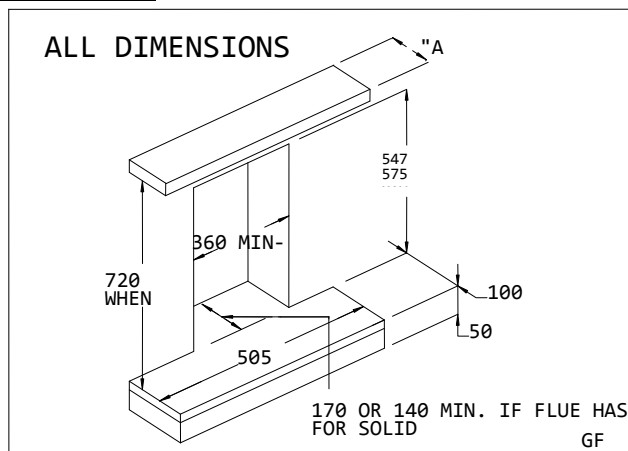

### **HEARTH**

The fire can be fitted in either a conventional hearth see diagram (I.E Tile fireplace etc), or plinth mounted, as a hole-in-the-wall installation

### **HOLE IN THE WALL**

The fire may be installed without a traditional fireplace, if it is installed this way, ensure the base of the fire opening is at least 50mm (2") from the floor surface. It will also be necessary for a non combustible shelf or plinth to be provided to support the fire front, A suitable shelf or plinth would need to project from the fixing plain of the fire a minimum of 100mm and be at least as wide as the appliance (505mm)

**IMPORTANT NOTE** when the fire is installed without a fireplace or non combustible back panel any wall surface or covering that comes in contact with the appliance and is not non combustible must be removed.

### **PURPOSE BUILT HEARTH AND SURROUND**

Purpose built superimposed fire-resistant hearths and back panels, specified as suitable by the manufacturers, may be used, or a suitable proprietary fire surround with a 150°C minimum rating.

## SECTION EIGHT Siting the Appliance continued

### SOFT FURNISHINGS

Care should be taken to prevent any damage being caused to surrounding soft furnishings or decoration e.g. many wall coverings may become discoloured if placed too close to the appliance.

### LIMITATIONS OF COMBUSTIBLE MATERIAL

Combustible material must be removed from the front the area behind the decorative trim.

#### Clearance to Shelf

Minimum clearance from hearth to underside of combustible shelf should be 660mm for a 100mm (4") shelf or 720mm for a 150mm (6") shelf, other sizes of shelf and clearances can be established using the "Shelf Chart"

Note: Ensure no combustibles are lower than 630mm above hearth.

#### Clearance to Sides of Fire

Minimum width between vertical sides of combustible surround should not be less than 700 mm provided fire is central to the surround and sides do not project more than 150 mm. When vertical side forward projection is increased by 12.5 mm add 50 mm to inside width of surround.

**NOTE: - A minimum clearance of 50mm each side is required to non-combustible materials this is to allow for servicing. The minimum clearance to a combustible sidewall is 250mm.**

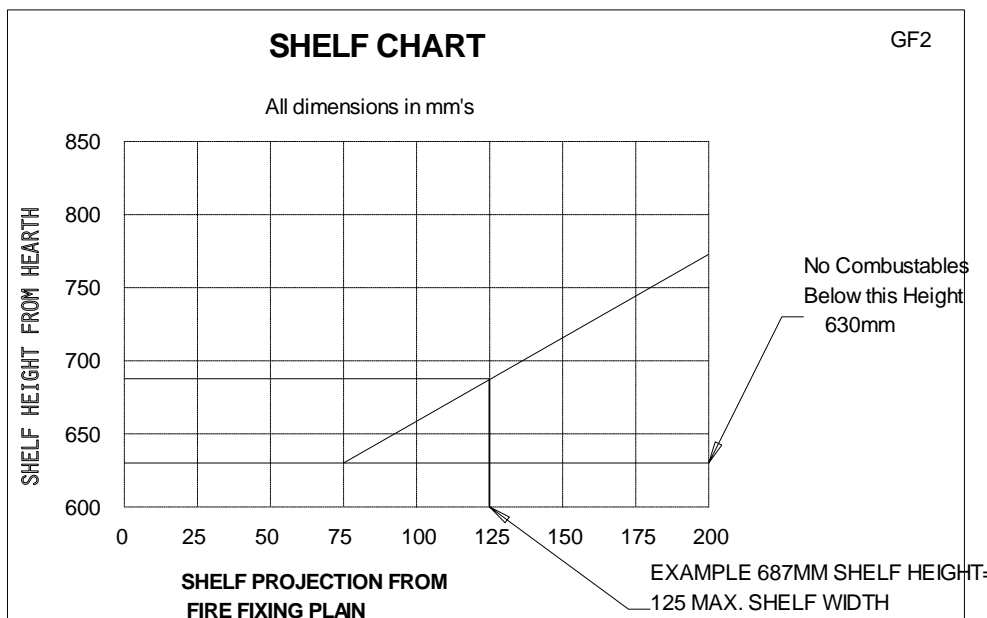

## SECTION NINE To Install the Appliance

### CHECKING THE FLUE AND FIRE OPENING

- Check that the chimney conforms to the required specifications as previously stated. Examine the condition and carry out any remedial work including any removal of debris from the base.
- If the flue has been used for solid fuel it should be swept prior to the installation
- Prior to installing the appliance a smoke test (using a smoke bomb) should be carried out to check that satisfactory smoke clearance has been established.  
If all the smoke is not drawn into the flue, pre-heat the flue with a blowtorch or similar and re-check. If there is any uncertainty examine for the cause and, if necessary, seek expert advice.  
**No combustible material shall be fitted inside the fireplace opening.**
- When installing this appliance against a dry lined (plasterboard) wall ensure that any void between the plasterboard and the wall is sealed with a suitable non-combustible material (i.e. plaster or mortar).

### CONNECTING THE GAS SUPPLY (AND ROUTING)

- Use rigid or semi – rigid tube to connect the gas supply. Determine the gas supply-piping route to the appliance before installing the fire. This may be from the front of the unit, either from the left or from the right hand, or it can be a concealed fitting from the rear of the appliance, via the grommet hole in the rear of the appliance casing ensure the grommet is pushed back into position after routing pipe work.
- A means of isolation from the gas must be provided for the appliance. An isolation elbow is provided for this purpose it may be positioned under the appliance burner (for a concealed connection) immediately adjacent to the appliance connection or either side of the appliance for front connecting.

## **SECTION NINE To Install the Appliance continued**

### **GLASS PANEL REMOVAL/REFITTING**

- Lift of the canopy.
- Remove the glass fixing clamp secure with two wing nuts and lift it out of the retaining brackets. Take care to support the glass panel when removing the fixing clamp.
- Replace in reverse order making sure that you engage the top and bottom catches properly and that there are no leaks around the glass seal. Ensure that the glass seal is position correctly (see above) thus minimising its visibility when the canopy is fitted.
- Ensure that the wing nuts are tightened evenly and the glass seal is compressed.

**Note: The appliance MUST no be used if the canopy or glass panel is missing or damaged.**

### **CONNECTING THE GAS SUPPLY**

**Note:-** An isolation valve (supplied) should be fitted in the gas supply .This will facilitate servicing.

For a concealed connection: -

- After removing the glass panel as described above.
- Remove the burner by undoing the two screws in the securing it into the burner support, and lift the burner away.
- Remove carefully the four piece refractory back linings and put safely aside.
- Remove the burner engine assembly by undoing the four fixing screws (2 in the engine top and 2 in the engine front) and slide the engine forward to clear the rear location.
- Remove the rubber (blind) grommet from the supply pipe inlet hole at the rear of the outer box and slide the box over the supply pipe. Fix outer box to the surround using one of the methods described in the next section. Take into account the requirements of BS 6891 1988 dealing with enclosed pipes.
- Refit the grommet over the pipe to ensure the seal around the inlet hole.
- Refit the burner engine and make connection between the supply isolating valve and the burner engine assembly inlet.
- For left hand or right hand (unconcealed) front gas connection, remove the appliance engine as described pervious and fix box to the surround as described in the next section.
- Refit the burner and run supply from left or right.

**Note:** Pipe work in the opening of the fireplace to the rear of the appliance must be suitably wrapped in accordance with the regulations.



## SECTION NINE To Install the Appliance continued

### FIXING FIRE INTO OPENING

**NOTE:** -Remove the glass panel and put safely to one side. Do not replace until installation is completed.

- Mark the position of flange holes required in the fireplace front, drill and insert wall plugs
- Remove the paper back from the length of seal and stick it around the rear of the front flange of the fire.

**NOTE:** -The seal must be positioned to ensure an airtight seal when the appliance is fitted.

- Fix the fire box in position with wood screws.

### CHECKING GAS SOUNDNESS

- Turn on the gas supply to the appliance and check for soundness in accordance with current codes of practice.
- Turn off the gas supply at the external Isolation valve.
- Remove the pressure test point screw from the inlet elbow and connect the pressure gauge.
- Turn on the gas to the appliance at the Isolation valve.
- Push down on the lever
- Check that the electrode is sparking at the gap between the thermocouple tip and the electrode; continue until pilot ignition is established.
- Lift the lever to the high rate position.
- Check the inlet pressure is 20mbar. +/- 1.0.
- Turn off gas supply, at the isolation valve. Disconnect the pressure gauge and replace the pressure test point screw.
- Turn on the supply to the appliance and check the pressure test point for soundness with detection fluid.

### OPTIONAL CABLE FIXING SYSTEM

Using a No 14 masonry bit drill four holes in the rear wall within the range shown, fit rawl plugs provided and screw eyebolts securely into plugs.

- Remove paper back from length of seal around the rear flange of the fire.

**NOTE:** -The seal must be positioned to ensure an airtight seal when the appliance is fitted.

- Position the fire close to fireplace, allowing sufficient access to thread the cable through the eyebolts. Feed the cables (one cable to each side) through the top holes in the firebox, through the eyebolts, and back through the bottom holes in the firebox as shown.
- Push firebox fully back in the fireplace opening, allowing it to seal against it to seal against the surround.
- Feed the cables through the adjusters and cable clamps and slide the clamps up the adjusters. Pull the cable as tight as possible and tighten the cable clamps. With a spanner tighten up the adjuster nut to tension the cable and make good the seal.

**Note:** - After fitting neatly coil up the excess cable. Do not cut off the excess cable.

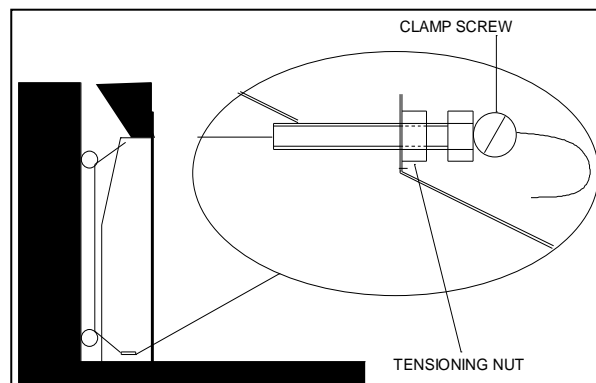
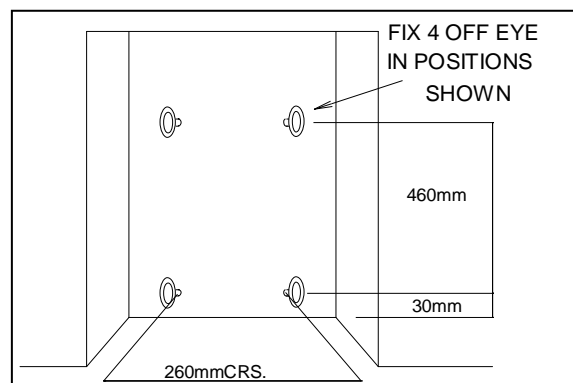

# FOCUS HE SLIMLINE SC Installation Instructions

## SECTION NINE To Install the Appliance continued

### CONNECTING LEVER AND VALVE LINKAGE

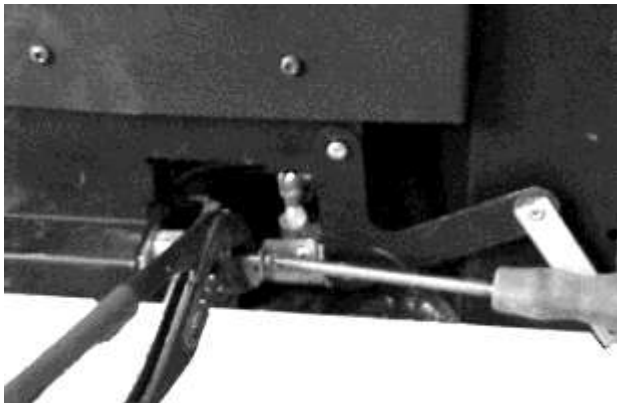

Taking great care grip the copper protective sleeve at the end of the gas control spindle (DO NOT GRIP SPINDLE IN ANY OTHER PLACE) as shown and remove the screw from the end



Ensure the spindle is pushed back inside the control valve as far as possible. Ensure the bell crank mechanism is swung up to give easy access to the gas connection point as shown.



Cut a cross slit in the rubber grommet and feed the appliance onto the 8mm-gas supply pipe. Position the restrictor elbow supplied and mark supply pipe at its cut off length. Remove appliance, cut pipe to correct length, refit appliance and make gas connection with restrictor elbow use 15mm A/F spanner taking care not to apply any force to the gas control spindle as above. Ensure the restrictor valve is opened and its cap replaced tightly.

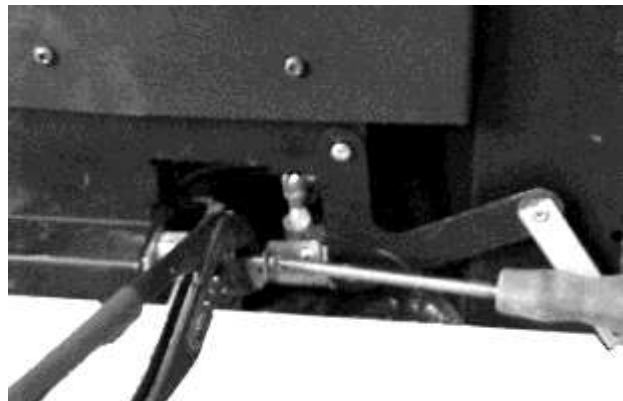

Check for gas soundness. Reconnect the bell crank mechanism as above ensuring that the gas control spindle is gripped only over the protective copper sleeve and no other part of the spindle as, ensure NO side strain is applied to the spindle.

## **FOCUS HE SLIMLINE SC** Installation Instructions

### **SECTION NINE** To Install the Appliance continued

#### **CONNECTING LEVER AND VALVE LINKAGE** Continued

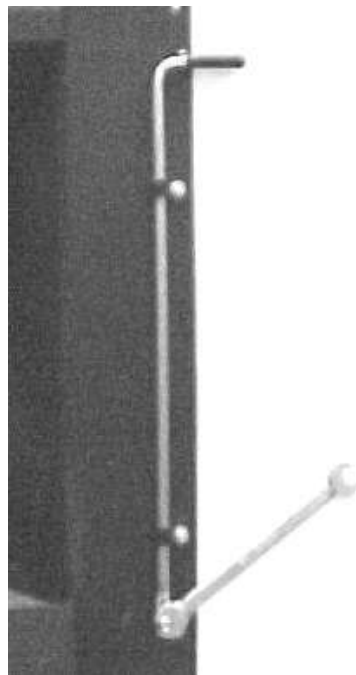
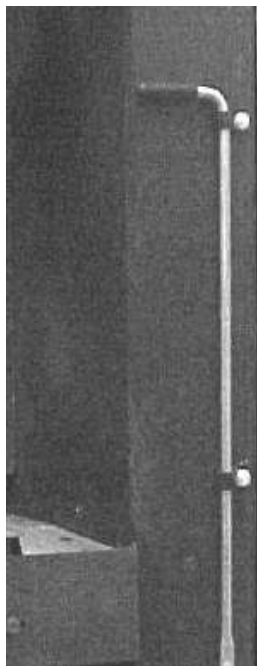

Flip the slide control lever round so that the rubber-capped end is protruding out to the right as shown in the left-hand picture. Check that it slides freely up and down in the nylon slide guides. Remove the nylock nut with a 7mm A/F spanner as shown

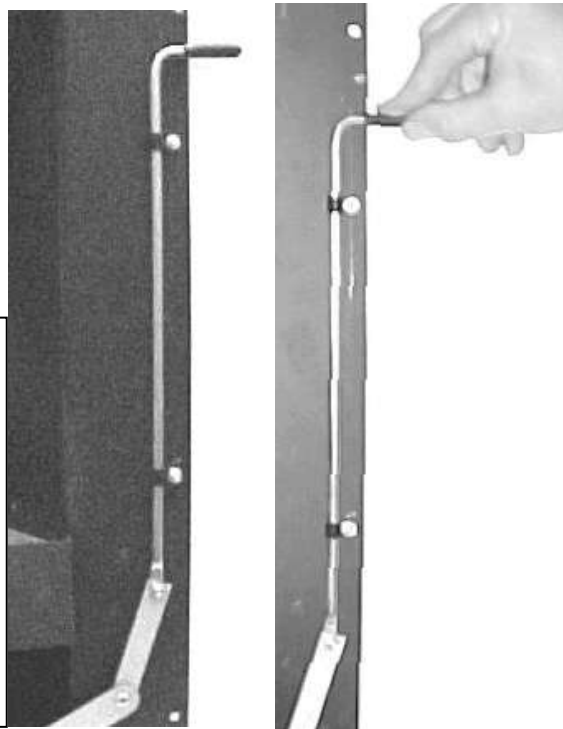

Connect the link lever to the stud at the end of the slide control lever and replace the nylock nut. **IMPORTANT TURN THE NUT UNTIL IT JUST TIGHTENS AND THEN TURN IT BACK A HALF TURN.** Check the operation on the lever and mechanism ensure that the lever springs back to the low position when it is released after pushing down

### **SECTION TEN** Checking Operation of Fire

#### **COAL BED LAYOUT**

**Important:** - Refer to the 'Heath & Safety Notice located on page 3 of this booklet before laying or replacing any refractory material.

Note : In the event of replacing coals please use only the specified number of coals as illustrated – Use coal provided for this fire only. In the interest of safety and efficiency of your appliance when replacing coals it is essential that the existing coals are removed and the new coals are replaced correctly as a complete set.

It is important that all the coals and moulded shapes are positioned as shown in these instructions.

**IF THE COALS ARE NOT POSITIONED CORRECTLY THIS MAY RESULT IN DAMAGE TO THE GLASS.**

LAY COALS AS SHOWN IN SECTION THREE.

## SECTION TEN Checking Operation of Fire Continud

### CHECKING FOR COMBUSTION PRODUCTS CLEARENCE

**IMPORTANT:**-The smoke test must be carried out with the fire starting from cold.

- Light the fire and leave at maximum input.
- Close all the doors and windows.
- After five minutes fit the smoke match in a holder and position as illustrated with the head of the match just inside the test opening.
- Run the match along the top edge **All smoke** must be drawn into the test opening if the clearance is satisfactory.
- If spillage occurs wait a further five minutes and repeat the test.
- Repeat the test with doors open and with any extractor fans in other rooms in operation.

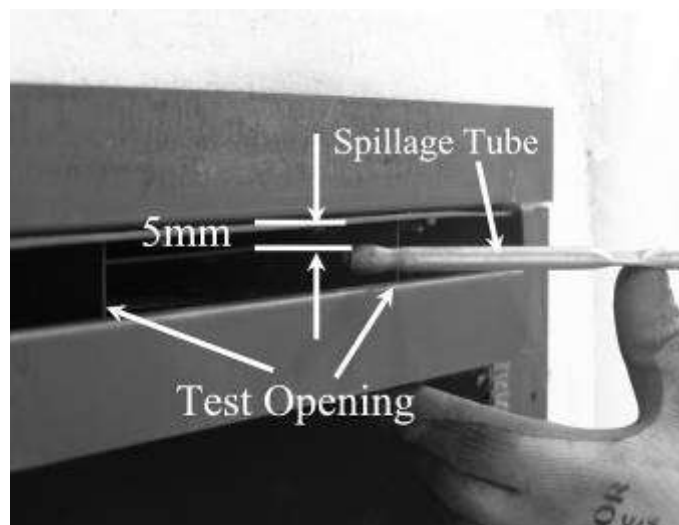

### THE FIRE FRET AND DECORATIVE TRIM

#### FIT FIRE TRIM AND FRET

- Fit the fire with the magnetic strips placed on the vertical side flange of the box.
- Offer the decorative trim up squarely and centrally and push into position.
- To remove the decorative trim, simply pull away from the magnetic strips.
- Fit the fire fret by standing on the hearth in front of the fire. Removal is the reverse of this operation.

#### ADVISE CUSTOMER THAT:

- The glass front of this fire acts as a dress guard, conforming to BS 1945 (1997) and satisfies the heating appliance regulations (1991) however; a fireguard conforming to BS6539 (1997) must be used to protect young children, the elderly or infirm.
- The curing effect of heating the coals and other refractory components will cause an initial odour. This is due to the starch used in the manufacturing process and is non-toxic.
- The fret is hand cast and some minor imperfections may be found on the surface.
- Any debris should be cleaned from the appliance. A vacuum cleaner can be used but only after all the loose coals have been removed. The appliance should be serviced annually by a competent person in accordance with these instructions, the flue checked, and the appliance checked for spillage in accordance with the method detailed in these instructions.
- Demonstrate the lighting and extinguishing procedures to the user and the removal and refitting of the brass trim fret and glass panel for cleaning. Refer to the user section of this booklet.

**Hand these instructions over to the user.**

# **FOCUS HE SLIMLINE SC Maintenance Instructions**

## **SECTION ELEVEN Maintenance**

### **GENERAL**

- Servicing should be carried out annually by a competent person such as a CORGI-registered person in accordance with the relevant regulations, to ensure the safe and correct operation of the appliance.
- Before commencing any service or replacement of parts, turn off the gas supply to the fire. After servicing check for gas soundness.
- When ordering spare parts please quote appliance name and serial number, these can be found on the data badge, which is located behind the fret on the right hand side of the appliance.
- At least once a years check for debris in the catchment area behind the fire and in the flue way.
- If soot has accumulated checks to establish cause rectify and clean flue or chimney accordingly.

### **PILOT LINTING**

Check pilot aeration holes for linting, use a vacuum cleaner nozzle taking care not to damage the pilot head.

### **FUEL BED CLEANING**

**Important: - Refer to the 'Health & Safety Notice located on page 3 of this booklet before cleaning or replacing any refractory material.**

The fuel bed components are delicate and they should be handled with great care.

The loose parts and moulded shapes may be removed for cleaning. They can be brushed very gently with a soft brush to remove dust or any deposits. A vacuum cleaner may only be used after the loose components have been removed.

Examine the fuel bed components for signs of cracking and replace if necessary. (IMPORTANT) see fuel bed layout procedure before attempting to replace loose fuel bed components, which should only be replaced as a complete set with no extra components being added.

### **REPLACEMENT OF GAS CONTROL TAP**

1. Turn off the gas supply by the isolating cock.
2. Remove fire fret.
3. Remove all Loose coals or Pebbles.
4. Remove moulded refractory parts.
5. Remove the screw from the end of the gas control spindle and swing the slide linkage to one side.
6. Shut off the gas at the restrictor elbow and disconnect the gas supply at the restrictor outlet.
7. Remove 4 screws fixing burner unit into the casing (2 lower front and 2 in top of burner).
8. Lift fire tray away, disconnecting cables from ignitor and banjo switch.
9. Undo the two screws retaining the silencer bracket.
10. Carefully lift away the top and two side refractory boards exposing the injector. Note original position.
11. Rotate the silencer plate positioned between the injector and injector plate so that access can be made to the injector plate retaining screws. Note original position of silencer plate.
12. Remove the two screws holding the main injector plate at the rear of the burner.
13. Disconnect the pilot burner at its elbow and the thermocouple from the rear of the gas valve.
14. Undo the three compression nuts securing the pipes to the gas valve and remove the two screws fixing the valve to the bracket.
15. Undo the two screws securing the gas valve mounting bracket to the underside of the burner.
16. Clean, service or replace gas valve.
17. Re-assemble the in reverse order.
18. Turn on the gas supply, check for soundness and re-commission appliance.

### **REPLACEMENT OF BURNER AND OR THE SILENCER**

**NOTE:** The silencer must not be modified and must be correctly positioned in its bracket (i.e. open end facing injector).

1. Turn off the gas supply by isolating cock.
2. Carefully lift away fire fret.
3. Remove the trim (secured with magnets) and glass panel (see Section Nine).
4. Lift away carefully all loose fuel bed components.
5. Lift away carefully rear matrix.
6. Remove burner secured with two screws.
7. Clean, service or replace as necessary.
8. Re-assemble in reverse order.
9. Turn on gas supply, check for gas soundness and re- commission appliance.

## **SECTION ELEVEN Maintenance Continued**

### **REPLACEMENT OF INJECTOR**

1. Remove burner tray (1-10 of Replacement Gas Control Tap).
2. Undo the compression nut on the supply pipe to the injector.
3. Remove the silencer pad carefully
4. Unscrew the locking nut holding the injector(s) on the chassis.
5. Clean or replace the injector(s). NOTE: -Do not use wire or a drill to clean out holes.
6. Re-assemble in reverse order.
7. Turn on gas supply, check for gas soundness and re- commission appliance.

### **REPLACEMENT OF OXY-PILOT ASSEMBLY**

**NOTE:** If the pilot assembly is replaced it must be replaced by an identical unit from the same manufacturer and replaced as a complete unit.

1. Remove burner tray (1-10 of Replacement Gas Control Tap).
2. Carefully pull off the ignition lead.
3. Disconnect the thermocouple at the end of the main control valve.
4. Remove the screws holding the pilot to the chassis
5. Carefully remove the oxy-pilot.
6. Remove burner tray (1-10 of Replacement Gas Control Tap).
7. Re-assemble in reverse order.

**FOCUS HE SLIMLINE SLIDE CONTROL**

**THIS IS YOUR EXTENDED FIVE YEAR PARTS**

**WARRANTY**

**PLEASE READ IT CAREFULLY AND ENSURE YOUR INSTALLER HAS FILLED IN THE FIRST PORTION, KEEP IT IN A SAFE PLACE SO THAT IT IS AVAILABLE WHEN YOUR CORGI ENGINEER CARRIES OUT THE ANNUAL SERVICE.**

**THIS IN NO WAY REDUCES YOUR STATUTORY RIGHTS**

**THE WARRANTY COMMENCES FROM THE DATE OF PURCHASE YOU MUST RETAIN YOUR RECEIPT OR INVOICE AS PROOF OF PURCHASE.**

**THIS EXTENDED WARRANTY SPECIFICALLY EXCLUDES SOFT REFRACTORY COMPONENTS, THE BULB AND ANY BATTERIES.**

Terms and Conditions

1. The appliance must be installed by a CORGI registered person.
2. The appliance must be used in accordance with the users instructions.
3. The appliance must be serviced annually by a CORGI registered person.
4. The service log must be correctly filled out and the record of annual services must be up to date and supported by receipts in each case.
5. This warranty is not transferable and relates to the original installation only.
6. The Registration Form must be correctly filled out and returned.
7. The appliance has not been subjected to misuse or accident or been modified or repaired by any person other than the authorised employee or authorised representative of Charlton and Jenrick Ltd.
8. The registration form must be returned within 3 months of purchase.

**PARAGON HELPDESK NUMBER 0845 5195991**

# WARRANTY COVER

## Important

For future reference we suggest you record the following details here, and keep the receipt as proof of purchase. This information may be asked for when you contact the helpdesk.

Model: **FOCUS HE SLIMLINE SC**

Serial No. --

This information can be found on the label attached to the packaging and on the data badge, which is located on the appliance flange, top right behind trim.

**Retailer Name:** \_\_\_\_\_

**Address:** \_\_\_\_\_

\_\_\_\_\_

\_\_\_\_\_

**Date of Purchase:**

## Service Log

The following information must be complete and supported by receipts as part of the conditions of the extended three year parts warranty and the appliance must be registered by completing and returning the registration document (last page of this booklet) to Paragon Fires.

Date of First annual service:

Engineer Name \_\_\_\_\_

Corgi Registration No.

Date of Second annual service:

Engineer Name \_\_\_\_\_

Corgi Registration No.

We may introduce modifications to products from time to time, and consequently the details given in this booklet are subject to alteration without notice.

## ***Paragon Fires***

Telford  
Shropshire  
TF3 3AR

Telephone 0845 5195991

Web Site [www.paragonfires.co.uk](http://www.paragonfires.co.uk)



**PLEASE REGISTER YOUR 12 MONTH WARRANTY WITH US TODAY**

Simply detach this sheet from this booklet, complete and return it in a stamped addressed envelope to:

**PARAGON FIRES**

Charlton and Jenrick Ltd  
UNIT D  
STAFFORD PARK 2  
TELFORD  
SHROPSHIRE  
TF3 3AR

**YOUR DETAILS**

Name \_\_\_\_\_

Address \_\_\_\_\_  
\_\_\_\_\_  
\_\_\_\_\_

Post Code

TELEPHONE No.

**PRODUCT DETAILS**

Model: **PARAGON HE FOCUS SLIMLINE** Serial No.

Date of Purchase

This information can be found on the label attached to the packaging and on the data badge, which is located on the appliance flange, top right behind trim.

**WHERE DID YOU PURCHASE THIS PRODUCT**

Name \_\_\_\_\_

Address \_\_\_\_\_  
\_\_\_\_\_  
\_\_\_\_\_

Post Code

TELEPHONE No.





<b>Product ID Label</b>	<b>A-0136</b>	<b>Serial No Prefix</b>	<b>KN</b>
Fire Box Labels: Spillage (1057) Data Badge			
Fire Box Grommet			
Burner Tray / Box Assembly			
Warning Label (Fire Guard)			
Coal Set (5322)			
Rear Matrix (5319)			
Front Matrix (5320)			
Glass Panel			
Canopy			
Restrictor Elbow (2613)			
Fixing (0705) (includes 4 magnets)			
Seal (4904)			
Battery (9V) / 7mm Spanner			
Owners Book			
ID Label & Packing Label			
Serial Number			
Inspector			

Focus HE Slimline Slide Control Pebble

<b>Product ID Label</b>	<b>A-0137</b>	<b>Serial No Prefix</b>	<b>KN</b>
Fire Box Labels: Spillage (1057) Data Badge			
Fire Box Grommet			
Burner Tray / Box Assembly			
Warning Label (Fire Guard)			
Pebble Set (5323)			
Rear Matrix (5319)			
Front Matrix (5321)			
Glass Panel			
Canopy			
Restrictor Elbow (2613)			
Fixing (0705) (includes 4 magnets)			
Seal (4904)			
Battery (9V) / 7mm Spanner			
Owners Book			
ID Label & Packing Label			
Serial Number			
Inspector			