

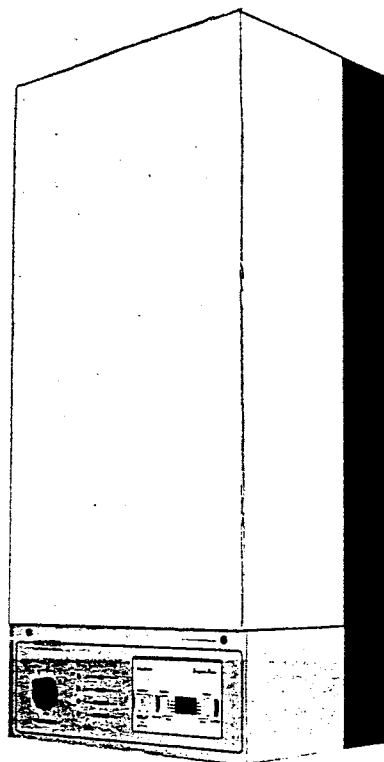

MALVERN 30, 40, 50 and 70
For Liquid Propane Gas

WALL MOUNTED, FAN POWERED, BALANCED FLUED, CONDENSING BOILER
INSTALLATION AND SERVICE INSTRUCTIONS.



IMPORTANT: The appliances are for use with **LIQUID PROPANE GAS ONLY.**
NOTE TO THE INSTALLER: LEAVE THESE INSTRUCTIONS WITH THE CUSTOMER

402139
M0560

Technical Data

BOILER MODEL	30	40
Heat Input	9.6 kW (32,600 Btu/h)	12.7 kW (43,500 Btu/h)
Heat Output 80 - 60 °C	8.1 kW (27,700 Btu/h)	11.0kW (37,400 Btu/h)
Heat Output 60 - 40 °C	8.8 kW (30,000 Btu/h)	11.7kW (40,000 Btu/h)
Setting Pressure (20 mb line)	13.5 mb (5.4 in)	10.1 mb (4.0 in)
Gas Consumption CV 1015 ,after 10 mins.	0.892 m³/h (31.5 ft³/h)	1.198 m³/h (42.3 ft³/h)
Main Burner	Aeromatic AC13/122551	Aeromatic AC13/122550
Gas Control	SIT. 083.00.20	SIT. 083.00.20
Burner Injector	DIA. 2.5	DIA. 3.2
Pilot Injector	SIT. 997.113/33	SIT. 997.113/33
Gas Connection	15mm Copper	15mm Copper
Dry Weight	33 kg	33 kg
Water Content	1.4 l	1.4 l
MAXIMUM Static Water Head	30 m	30 m
MINIMUM Static Water Head	1 m	1 m
MAXIMUM Flow Temperature	82 °C	82 °C
Recommended Water Flow	7 - 9 l/m	8 - 10 l/m
MINIMUM Water Flow	4 l/m	5 l/m
Flow & Return Connections	22 mm Copper	22 mm Copper
Electrical Supply	240V ~ 50Hz 40W	240V ~ 50Hz 40W
External Fuse Rating	3A	3A
Dimensions	850 high 400 wide 300 deep	850 high 400 wide 300 deep
Service Allowance	450 front 30 above , 100 below 75 left & right	450 front 30 above , 100 below 75 left & right
Terminal Dimensions	120 high 120 wide 30 deep	120 high 120 wide 30 deep
Flue Diameter mm	84	84
Length min, max mm	100 - 2000	100 - 2000

Technical Data

BOILER MODEL	50	70
Heat Input	15.9 kW (54,300 Btu/h)	22.2 kW (75,750 Btu/h)
Heat Output 80 - 60 °C	13.7 kW (46,700 Btu/h)	19.1kW (65,200 Btu/h)
Heat Output 60 - 40 °C	14.7 kW (50,000 Btu/h)	20.6kW (70,000 Btu/h)
Setting Pressure (20 mb line)	14.1 mb (5.5 in)	14.1 mb (5.5 in)
Gas Consumption CV 1015, after 10 mins.	1.487 m³/h (52.5 ft³/h)	2.08 m³/h (73.5 ft³/h)
Main Burner	Aeromatic AC13/122550	Aeromatic AC13/122552
Gas Control	SIT. 083.00.20	SIT. 083.00.20
Burner Injector	DIA. 3.2	DIA. 3.9
Pilot Injector	SIT. 997.113/33	SIT. 997.113/33
Gas Connection	15mm Copper	15mm Copper
Dry Weight	33 kg	36 kg
Water Content	1.4 l	1.6 l
MAXIMUM Static Water Head	30 m	30 m
MINIMUM Static Water Head	1 m	1 m
MAXIMUM Flow Temperature	82 °C	82 °C
Recommended Water Flow	10 - 12 l/m	14 -16 l/m
MIMIMUM Water Flow	5 l/m	5 l/m
Flow & Return Connections	22 mm Copper	28 mm Copper
Electrical Supply	240V ~ 50Hz 40W	240V ~ 50Hz 40W
External Fuse Rating	3A	3A
Dimensions	850 high 400 wide 330 deep	850 high 500 wide 340 deep
Service Allowance	450 front, 30 above , 100 below 75 left & right	450 front, 30 above , 100 below 75 left & right
Terminal Dimensions	120 high 120 wide 55 deep	160 high 160 wide 55 deep
Flue Diameter mm	110	110
Length min, max mm	100 - 2000	100 - 2000

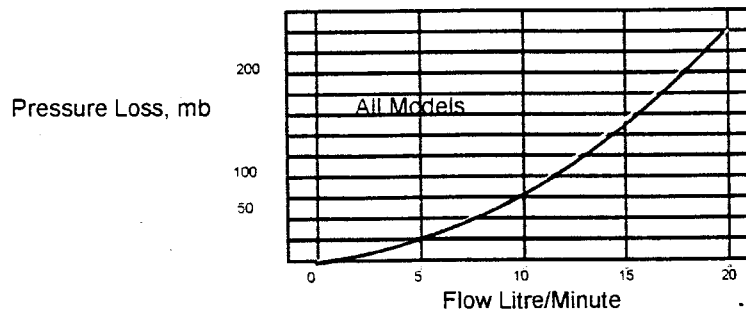

INTRODUCTION

These Instructions cover a range of lightweight, wall hung, gasfired, condensing boilers. The flue system is room sealed and fan assisted on the flue side. The ignition system is fully automatic.

There are several models with different outputs - see table for details. An internal programmer kit is available as an option.

The boiler casing is of white enamelled mild steel.

The boilers are suitable for connection to open vented or sealed systems. These systems may be pumped central heating or pumped central heating combined with a pumped indirect domestic hot water circuit. Gravity circuits must NOT be used.

Adequate arrangements for completely draining the system, by provision of drain cocks MUST be provided.

Gas Safety (Installation and Use) Regulations, 1984 (as amended).

It is the law that all gas appliances are installed by competent persons (e.g. CORGI) in accordance with the above Regulations. Failure to install appliances correctly could lead to prosecution.

It is in your own interest, and that of safety, to ensure that the law is complied with. The installation of the boiler MUST also be in accordance with the current I.E.E.. Wiring Regulations, the Local Building Regulations, Building Standards (Scotland), the Bye Laws of the Local Water Undertaking, any relevant requirements of the Local Authority, and Health and Safety document No 635, "Electricity at Work Regulations 1989".

Detailed recommendations are contained in the following British Standard Codes of Practice.

Codes of Practice.

BS.6798 Installation of gas fired hot water boilers of rated input not exceeding 60kW.

BS.5449 :1 Forced circulation hot water systems (small bore and microbore domestic central heating systems).

BS.5546 Installation of gas hot water supplies for domestic purpose (2nd Family Gases).

BS.5440 :1 Flues (for gas appliances of rated input not exceeding 60kW).

BS.5440 :2 Air supply (for gas appliances of rated input not exceeding 60kW).

BS 6891 Specification for installation of low pressure gas pipework.

BS 7074: 1 Application, selection and installation of expansion vessels and ancillary equipment for sealed water systems.

IMPORTANT. It is important that no external control devices are directly connected to this appliance - unless covered by these 'Installation and Servicing Instructions' or otherwise recommended by the manufacturer.

If in doubt please enquire.

Any direct connection of a control device not recommended by the manufacturer could infringe the Gas Safety (Installation & Use) Regulations, the above regulations and the normal appliance warranty.

Manufacturer's notes must NOT be taken, in any way, as overriding statutory obligations.

LOCATION OF BOILER

The boiler MUST be installed on a flat and vertical non-combustible wall, capable of adequately supporting the weight of the boiler and any ancillary equipment.

THE BOILER IS NOT SUITABLE FOR EXTERNAL INSTALLATION.

IMPORTANT NOTICE.

If the boiler is to be fitted in a timber framed building it should be fitted in accordance with the British Gas publication 'Guide for Gas Installations in Timber Frame Housing', reference DM2. If in doubt, advice must be sought from the Local Gas Region of British Gas.

The boiler may be installed in any room or internal space, although particular attention is drawn to the requirements of the current I.E.E. Wiring regulations and, in Scotland, the electrical provisions of the Building Regulations applicable to Scotland with respect to the installation of the boiler in a room or internal space containing a bath or shower.

Where a room sealed appliance is installed in a room containing a bath or shower then the appliance and any electrical switch or appliance control, utilising mains electricity should be so situated that it cannot be touched by a person using the bath or shower.

Where installation will be in an unusual location then special procedures may be necessary and BS.6798 gives detailed guidance on this aspect.

A compartment used to enclose the boiler **MUST** be designed and constructed specially for this purpose. An existing cupboard, or compartment, may be used provided it is modified for the purpose. Details of essential features of cupboard compartment design, including airing cupboard installations are given in BS.6798.

In siting the boiler, the following limitations **MUST** be observed:

1. The position selected for installation **MUST** allow adequate space for servicing in front of the boiler and for air circulation around the boiler.
2. This position **MUST** also permit the provision of a satisfactory balanced flue termination.
3. This position **MUST** also permit the provision of a satisfactory connections to the condensate drain.

GAS SUPPLY

The Local Gas Region should be consulted, at the installation planning stage, in order to establish the availability of an adequate supply of gas.

An existing service pipe must **NOT** be used without prior consultation with the Local Gas Region, or by a local Gas region contractor. An existing meter should be checked preferably by the Gas region, to ensure that the meter is adequate to deal with the rate of gas supply required.

Installation pipes should be fitted in accordance with BS.6891: 1988.

Do **NOT** use pipes of a smaller size than the boiler inlet gas connection.

FLUEING

Detailed recommendations for flueing are given in BS.5440: 1.

The following notes are intended for general guidance.

1. Be aware of the plume from the flue and the wetting effect it has to adjacent property.
2. The flue can be taken to the left, right or rear of the appliance.
3. The boiler is provided with standard flue kit that will reach 500mm (20 in). An extended flue kit is available which enables the flue to be extended straight to 2000mm (79 in),(30 & 40 Part No 7722, 50 & 70 Part No 7721). The air duct must be supported every 700mm (30 in) with the clips provided.
4. The boiler **MUST** be installed so that the terminal is exposed to external air.
5. It is important that the terminal allows the free passage of air across it at all times.
6. The acceptable spacing from the terminal to obstructions and ventilation openings are specified in Table 1.
7. Where the lowest part of the terminal is fitted less than 2m(6.6ft.) above a balcony, above ground, or above a flat roof to which people have access then the terminal **MUST** be protected by a purpose designed guard.

Terminal Position	Minimum
Below window or vent	300 mm
Below gutter or pipes	75 mm
Below eaves	200 mm
Below balcony or roof	200 mm
From vertical pipe	75 mm
From corners	300 mm
Above ground, roof or balcony	300 mm
From facing surface	600 mm
From facing terminal	1200 mm
From opening under a car port	1200 mm
Vertically from a terminal	1500 mm
Horizontally from a terminal	300 mm

Table 1.

Terminal guard Model K3 6.5 x 11
(plastic coated) (GC No 393554)
is available from:-

Tower Flue Components Ltd.
Tower House.
Vale Rise.
Tonbridge KENT TN9 1TB
0732 351555

IMPORTANT. It is absolutely ESSENTIAL to ensure, in practice, that products of combustion discharging from the terminal cannot re-enter the building, or any other adjacent building, through ventilators, windows, doors, other sources of natural air infiltration or forced ventilation/air conditioning.

If this should occur, the appliance MUST be turned OFF IMMEDIATELY and the Local Gas Region consulted.

TERMINAL

The terminal assembly of the balanced flue can be adapted to accommodate various wall thicknesses from 100mm to 2000mm. If a terminal guard is fitted, then the terminal must be central.

Note. Reference for the terminal position can be made from Table 1.

AIR SUPPLY

Detailed recommendations for air supply are given in BS.5440 Pt. 2.
The following notes are intended for general guidance.

1. It is NOT necessary to have a purpose provided air vent in the room or internal space in which the boiler is installed.
2. If the boiler is to be installed in a cupboard or compartment, permanent air vents are required (for cooling purposes) in the cupboard or compartment, at both high and low levels.

The air vents must either communicate with a room/internal space, or vent directly outside.

Vents required for a cupboard/compartment are specified in Table 2, and are related to the maximum rated heat input of the boiler.

Model	Position of vent	Air from room	Air direct from outside
30	High & Low	104 cm ²	52 cm ²
40	High & Low	135 cm ²	67.5 cm ²
50	High & Low	171 cm ²	85.5 cm ²
70	High & Low	240 cm ²	120 cm ²

Table 2.

Note: Both air vents MUST communicate with the same room or internal space, or MUST both be on the same wall to outside air.

WATER SUPPLY

The central heating system should be in accordance with the relevant recommendations given in BS.6798 and , in addition, for smallbore and microbore systems - BS.5449:1.

The domestic hot water system, if applicable, should be in accordance with the relevant recommendations of BS.5546.
Copper tubing to BS 2871:1 is recommended for water carrying pipework.

The hot water storage cylinder MUST be of the indirect type and should preferably be manufactured of copper.

The hot water cylinder, & ancillary pipework, not forming part of the useful heating surface should be lagged, to prevent heat loss and any possible freezing, particularly where pipes run through roof spaces and ventilated underfloor spaces.

Draining taps MUST be located in accessible positions which permit the draining of the whole system, including boiler and hot water storage vessel. Draining taps should be at least ½ in. nominal size and be in accordance with BS.2879.

CONDENSATE DRAIN.
Refer to Fig. 2, and 13.

A condensate drain is provided on the boiler, this drain must be connected to the household drainage point, or soakaway on site. All pipework and fittings in the condensate drainage system **MUST** be made of plastic. Refer to British Gas publication "Guidance notes for installation of domestic condensing boilers"

No other materials may be used.

The drain outlet on the boiler is :
Polypipe, 21.5mm pushfit overflow pipe.

SEALED SYSTEMS

A sealed system should follow the guidelines given in the Code of Practice BS 7074 :1. It should include a safety valve to BS 6750 Pt 1, fitted close to the boiler, without an intermediate valve to the system and in a position where it can be tested. It should be pre-set to operate at 3 bar (45 lbf/in²) and sited to discharge through a pipe to a safe outlet.

An expansion vessel complying with BS 4814 must be fitted to the system close to the return side of the pump. The connection should be not less than 15mm and without a valve or restriction. Size the vessel by using the graph below.

1. Choose a vessel pressure by taking the static head of the system, adding 0.3 bar, and taking the nearest larger size.
2. Select the volume size from the graph below by finding the system volume, rising vertically to the line marked with the chosen vessel pressure, then to the left to read off the vessel volume. Choose that size or larger from the manufactures range.

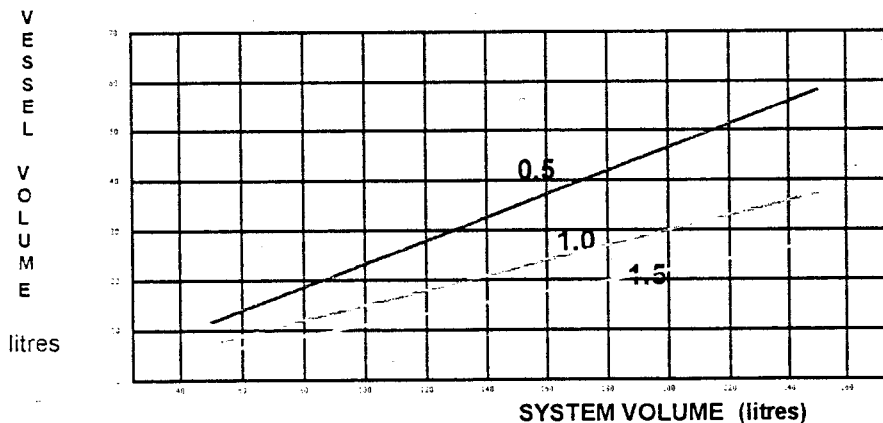

A pressure gauge with a fill pressure indicator and a range of 0-4 bar should be fitted close to the expansion vessel in a visible position.

A design as detailed below should be used for the filling connection, it utilises a BS 1010 stop valve, a double non-return valve and filling loop fitted at low level and should be installed with the approval of the local Water Undertaking.

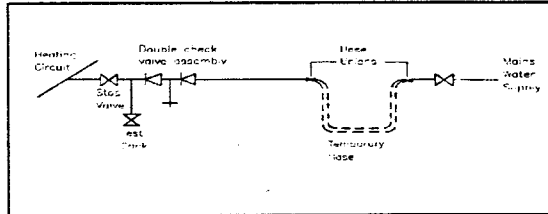

ELECTRICITY SUPPLY.

Refer to Figs. 3,4,5, and 6.

Wiring external to the appliance **MUST** be in accordance with the current I.E.E.. Wiring Regulations and any Local Regulations which apply.

The boiler is supplied for 240V ~ 50Hz.
Single phase. Fuse rating is 3A.

The method of connection to the mains electricity supply **MUST** facilitate complete electrical isolation of the boiler, preferably by the use of a fused double pole switch having a 3mm (1/8in.) contact separation in both poles and servicing only the boiler and system controls.

The point of connection to the mains should be readily accessible and adjacent to the boiler, except that, for bathroom installations, the point of connection to the mains MUST be situated outside the bathroom.

Note. Where a room sealed appliance is installed in a room containing a bath or shower, the appliance, any electrical switch or appliance control utilising mains electricity should be so situated that it cannot be touched by a person using the bath or shower.

INSTALLATION OF BOILER

Suggested procedure:

1. Site to suit system and terminal limitations.
2. Mark fixing and flueing positions (Fig. 7).
3. Drill flue hole.
4. Fix boiler turning box to the wall.
5. Remove the case from boiler module
6. Plumb module for water and gas OFF the wall (access is much better).
7. Fix module to turning box and the wall.
8. Plumb tails to system and gas.
9. Test for leaks.

Space Required for Installation and Service.

Right or Left	75 mm	3 in
Above	30mm	1in.
Below	100mm.	4in.
In Front	450mm.	18in.

REMOVAL OF THE CASE

1. Lower the electrical cover. This is detached by unscrewing the two pozidrive screws located at the top of the control panel, pulling the cover towards you and carefully lowering. Care should be taken to prevent strain on the cables and connections.
2. Remove the case by unscrewing the two pozidrive screws located at the bottom and rear of the case, and lifting and pulling forward off the two pegs which are located at the top. The case should be kept vertical as it is removed.

HANGING BRACKET AND TURNING BOX

1. Separate the hanging bracket from the turning box by unscrewing the two M5 pozidrive screws located in the back of the box. These screws should be retained, see Fig.8.
2. Screw the hanging bracket to wall with the four screws and rawlplugs supplied. Ensure that the top of the hanging bracket is level and at the desired height for the top of the boiler. See Fig.9.
3. Prepare the turning box for the required flue outlet. For rear entry use as supplied. For left or right outlet, remove appropriate blanking plate and assemble on rear outlet.

Note All holes should be left with a screw, to seal them.

ASSEMBLY OF FLUE PIPE AND AIR DUCT PIPE TO TURNING BOX

1. Mark wall for flue outlet then core drill to give a 0 to 3 degree slope down towards the boiler.

100mm for the 30 & 40
120mm for the 50 & 70.

(The following is based on the flue tube being supplied with the straight and elbow connectors being pre-assembled, the one NOT required being cut off during installation.)

Right or Left Outlet

1. Using the saddle clamp secured with two self tapping screws to clamp the 50mm flue tube with elbow connector in turning box. See Fig.10.
2. Locate the top of the turning box on the two studs and screw the turning box to hanging bracket using two M5 pozidrive screws. See Fig.8.
3. Measure carefully and saw off the 50mm tube to give required projection from wall. See Fig. 10.
4. Temporarily, assemble the air duct tube through wall and into the turning box up to the stop. (See Fig.11) and measure it carefully to give required projection from the wall.

Remove and saw off tube. The flue pipe must project more than the outer air duct when assembled, see Fig.11.

Note: It is acceptable to obtain this dimension by pulling the air duct away from the air duct stop, provided there is a minimum of 10mm (1/2in.) insertion into the turning box and that a satisfactory seal is achieved as in item 5 below.

5. Final assembly will require the turning box to be unscrewed from the wall, the flue to be fitted into it and screwed back on to the wall.

6. In order to seal the air duct to the turning box apply a 4mm diameter bead of silicone sealant around tube 10mm from the end and rotate home wiping the sealant into the joint. Position the air duct support clips provided every 700mm.

Rear Outlet

Install as above but using the STRAIGHT connector in turning box.

Follow the instructions under Right or Left outlet, points 1,2, 3, and, 5.

TERMINAL

Fix to the outside wall with the screws provided. The top has no holes and is marked 'TOP'. If a guard is fitted, the terminal should be at its centre.

PLUMBING

Prepare the flow and return pipe work on the rear of the boiler. **Note:** It is important that the joints on this pipework are leakproof as access is very limited after fitting the boiler module.

SECURING THE BOILER ON TO THE TURNING BOX

1. With the bottom of the boiler away from the wall, engage the two holes in the back plate onto the two 5mm studs of the hanging bracket. Now by gently lowering the bottom of the boiler against the wall the fan spigot should engage in the flue connector. Observe the correct engagement of the fan spigot into the flue.

2. Replace the two M5 screws around the fan that hold the turning box to the back panel.

3. Replace the decorative top trim, if required, on the two studs and secure the boiler to the bracket using M5 nuts on the two studs.

LOWER BOILER FIXING

The boiler is finally attached to the wall by two screws, washers and a rawlplugs. See Fig.7.

GAS CONNECTION

The 15mm. copper gas connection point is shown in Fig.2.

A minimum of 20mb. (8in. w.g.) must be available at the boiler inlet, with the boiler and other connected appliances firing.

Check for gas soundness (B.S. 6891: 1988) in pipework to boiler using a manometer.

Open the gas cock

Gas soundness within the boiler should be checked using sense of smell and/or leak detection fluid.

Check the burner bar pressure with a manometer connected to the control and adjust if required with the nut beneath the black rubber cap on the underside of the valve.

CONDENSATE CONNECTION.

The position of the plastic condensate drain pipe is shown in Fig.2.

Installation pipework **must be in plastic** to a suitable drain location with a gradient of 2.5° (45mm/ meter run) minimum. If connected to other drainage a trap is required (see Figs. 13 and 14).

Internal runs may be in a minimum of 19mm pipe but external **MUST** be made in a minimum of 32mm pipe and if possible insulated to avoid problems from freezing.

SYSTEM DESIGN

General principals

Condensing Boilers give their best performance when the system water temperature is as low as possible and still achieve the desired room temperatures. Oversized radiators make this easier to achieve but are not essential as, even in a standard designed installation, most of the boilers' working hours are spent with the system producing much less than the designed output. This is because the outside temperature is often higher than the figure used for the design, typically -1 to -2°C.

Consequently, the standard 'Y' plan design using 3-port flow share valve, room thermostat and cylinder thermostat, is a perfectly suitable minimum.

Thermostatic radiator valves can be used but it is essential to fit a bypass to maintain minimum flow conditions. A TRV controlled system would also be improved by the addition of an anti-cycling device.

The boiler waterside is completely copper so all good corrosion inhibitors are suitable.

Designs

The following designs are all acceptable:

1. Sealed system to BS.6798 and BS.5449 :1
2. Combined Feed and Vent systems.
3. Separate Cold Feed and Vent systems.

The pump may be on the flow or return, but careful note of its position relative to the feed and vent MUST be made to avoid pumping over, or sucking in air. It should always be installed with isolating valves as close as possible on both its flow and return.

The design temperature difference across the boiler for optimum operating efficiency is 20°C. If thermostatic valves or zone valves are used ensure the minimum flow shown in the Technical Data is possible.

ELECTRICAL CONNECTIONS

WARNING: The appliance MUST be earthed.

All wiring for the boiler and system controls MUST conform to I.E.E.. Wiring Regulations, and work should be tested using a suitable meter, for Earth Continuity, Polarity, Short Circuit and Resistance to Earth.

The supply must be through a common isolator, a double pole 3A fused isolating switch with a contact separation of 3mm minimum on both poles. The cable used should be no less than 0.75mm² to BS.6500 PVC, 3 core, and fixed using the built in securing clamps, ensuring the earth connection is longer than the Live and Neutral.

Access to the boiler terminal strip is made by releasing the two plated screws on the front panel and by sliding the bottom section of the boiler forward until it clears.

The boiler internal wiring is shown in schematic and physical form in Fig. 3, 4, 5, and 6, connections are as follows :-

Terminal	Connection
	Earth
L	Mains Live
L	Programmer Live
N	Mains Neutral
N	Pump Neutral
N	Programmer Neutral
1.	Pump Live
2.	No Connection
3.	System Control switched live
4.	Programmer Hw off
5.	Programmer Hw on
6.	Programmer Ch on

The boiler includes a pump overrun thermostat and an external pump MUST be powered from terminal No.1.

For systems using an external programmer, the electrical wiring should follow the relevant control manufacturer's recommendations, with the switched live from the controls returning to terminal No.3 in the boiler.

For systems using the boiler with an internal programmer, the required programmer connections are made available at terminal L and N and Nos. 4, 5, and 6. Full details of the optional programmer kit are supplied with the kit.

COMMISSIONING

General

The elimination of air from systems is essential to minimise the occurrence of heat exchanger and general system noise. It is particularly important for lightweight boilers.

Metal swarf and flux chemicals make a very aggressive mixture, the destructive nature of which can be drastically reduced by flushing. Consequently this is a mandatory step in the commissioning procedure.

Low water content, fabricated boilers are vulnerable to damage by air, particularly when the system water is 'hard'. (Contains a lot of dissolved calcium salts). The result of this damage is evident in noisy boilers and reduced service life.

Removal of air from a system mainly takes place when the water is stopping, starting or not moving at all. It is removed most easily when it is in large bubbles, but the action of the pump is to chop it up so that it becomes a foam, which is extremely difficult to remove.

Two or three second bursts on the pump at the initial stage will reduce the risk of foam formation.

Sloping the pipe runs towards the vent points will greatly aid air removal. Sloping pipes are not just a feature of gravity systems but can greatly aid the pumped system - because air can move towards a vent when the pump stops.

Air is dissolved in water but is released when heated. Always run a system at maximum temperature for at least 15 minutes to enable this potential problem to be removed during commissioning.

COMMISSIONING PROCEDURE

The boiler is fitted with automatic ignition and will start when the gas cock is open, mains is connected to the boiler and the controls calling for heat. **NOTE:** because of a built in delay, cycles by the Control Thermostat do not fire the boiler for 3½ minutes, however cycles by the System Controls are not delayed.

It is strongly suggested that the following stages of commissioning are followed, and not an immediate connection of all services.

Carry out electrical tests as stated in Electrical Connections if not already done so.

With all radiator valves fully open, fill the system but do not start pump.

Sealed Systems only :

With the temporary hose connected, fill from the mains supply, then follow the procedure below.

Check for water soundness and rectify where necessary.

DO NOT TURN ON GAS

Drain the system by opening all draincocks. This will flush the system of flux and swarf.

Pour 3/4 of the inhibitor in and fill the system with clean water and vent air from radiators and pipework. (**Sealed Systems only :** *Pour in all the inhibitor, and fill to required pressure plus 0.3 bar to allow for venting*)

Switch on the electrical supply to the boiler and switch the programmer to DHW. Switch off after about five seconds and vent all points again. Repeat this for 5 minutes.

(Sealed Systems only : *re-pressurise if required*)

(This procedure prevents substantial amounts of air being dispersed through the system as small bubbles).

Turn on pump (do not turn on gas) and run for at least 30 minutes with 3 port valve in DHW position most of the time. Stop pump at five minute intervals and vent until no more air can be removed and air noises are no longer produced at the boiler. While the system is venting check again for water soundness.

Check for gas soundness (B.S 6891: 1988) in pipework to boiler using a manometer. Open the gas cock and after purging the system, the boiler will light automatically. Run system at maximum thermostat setting.

Gas soundness within the boiler should be checked using sense of smell and/or leak detection fluid. Continue running for 15 minutes, venting every 5 minutes.

IMPORTANT Check that the burner pressure is correct by using a manometer connected to the multifunctional control, and that the inlet pressure is at least 20 mbar. If it needs adjustment this can be made using the nut under the rubber cap on the underside of the control (see Fig. 1).

The pilot is non-adjustable.

Check the pilot flame supervision by detecting the voltage on the Pilot solenoid (M_L on the sequence board), turn off the gas cock. The voltage on the valve should disappear within ONE second.

The gas valve opens in two steps, the first low-rate step can be adjusted to the required 5 mBar in the following manner. Fit a U gauge to the outlet pressure testpoint and remove plug from 'Port B'. With a finger sealing 'Port B', start boiler and observe pressure, adjust with 'Step opening adjuster'.

Note: The step opening action takes 20 seconds to reset after each operation.

If fitted check the operation of the system bypass with system hot, the minimum flow rate through the boiler should be as shown in the Datable.

Set the pump speed to the highest setting that does not provoke unreasonable operational noise within the system.

(Sealed Systems only : re-pressure to required pressure and set the gauge indicator)

With the system hot, check again for water soundness. Refit the case to the boiler. Add remainder of corrosion inhibitor. Balance the system in the normal way to obtain even heating of all radiators.

If fitted set the cylinder thermostat to 60°C, or lower if preferred.

Explain and demonstrate the operation of the system to the user.

Commission Check List (hydraulic)

The key points which must be observed closely are shown below.

With radiator valves and vents open fill system. **Do not use pump. Do not light gas** Check for and rectify leaks.

Drain to flush system. Refill system adding 3/4 of the inhibitor. **Do not light boiler.**

Vent all radiator and air release points. Run pump for 5-10 second bursts and revent. **Do not light boiler.**

Run pump for at least 30 minutes. Stop at 5 minute intervals to vent. Continue venting until no more air noise can be heard.

Light boiler and run at max thermostat setting. Continue for 15minutes, venting every 5 minutes. Add remainder of inhibitor.

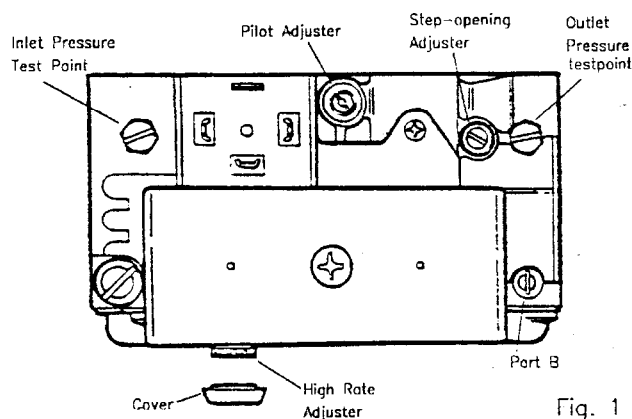
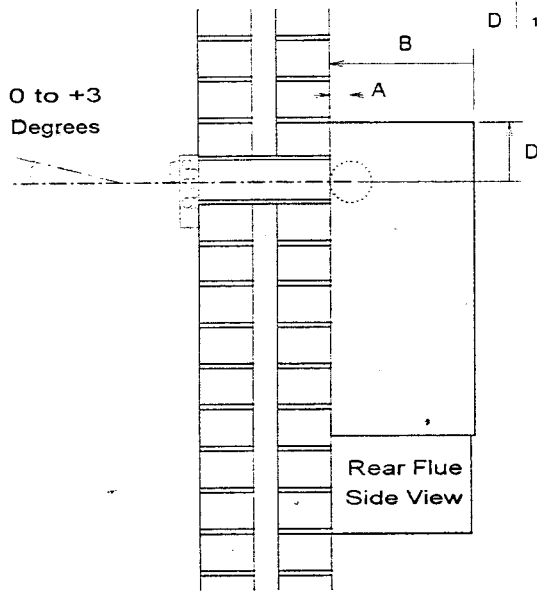

Fig. 1

INSTALLATION DIMENSIONS
SERVICE ACCESS

	30	40	50	70
A	50	50	64	64
B	300	300	330	340
C	400	400	400	500
D	125	125	138	138



Flue 100mm to 2000mm
Left, right or rear

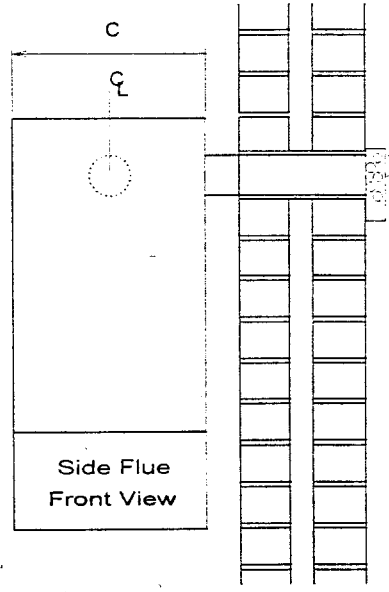

Service Access
Front 450mm Above 30mm
Sides 75mm Below 100mm

Suggested core drill
100mm 30 & 40
128mm 50 & 70

PIPE CONNECTIONS
AND LOCATIONS

	30/40/50	70
W	24	27
X	43	73
Y	33	63
Z	135	185

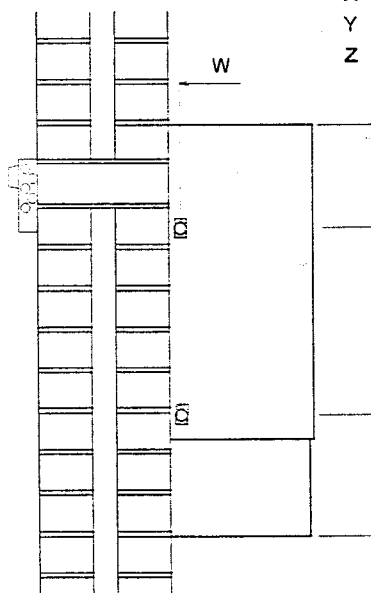

Connections : 22mm (30,40,50)
28mm (70)
Exit up or down

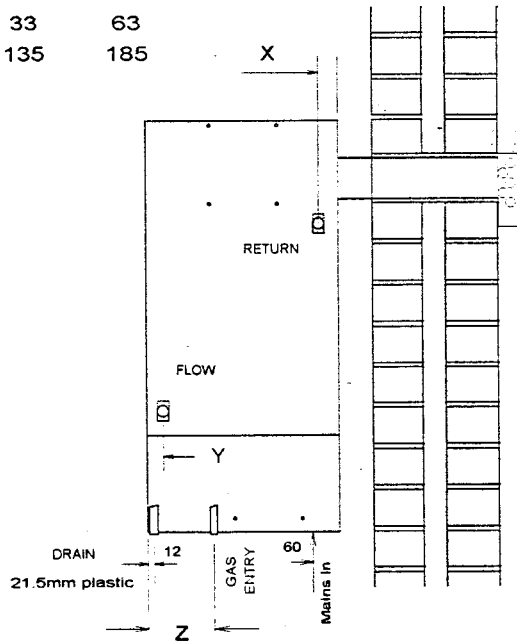

Fig. 2

319049

SCHEMATIC WIRING

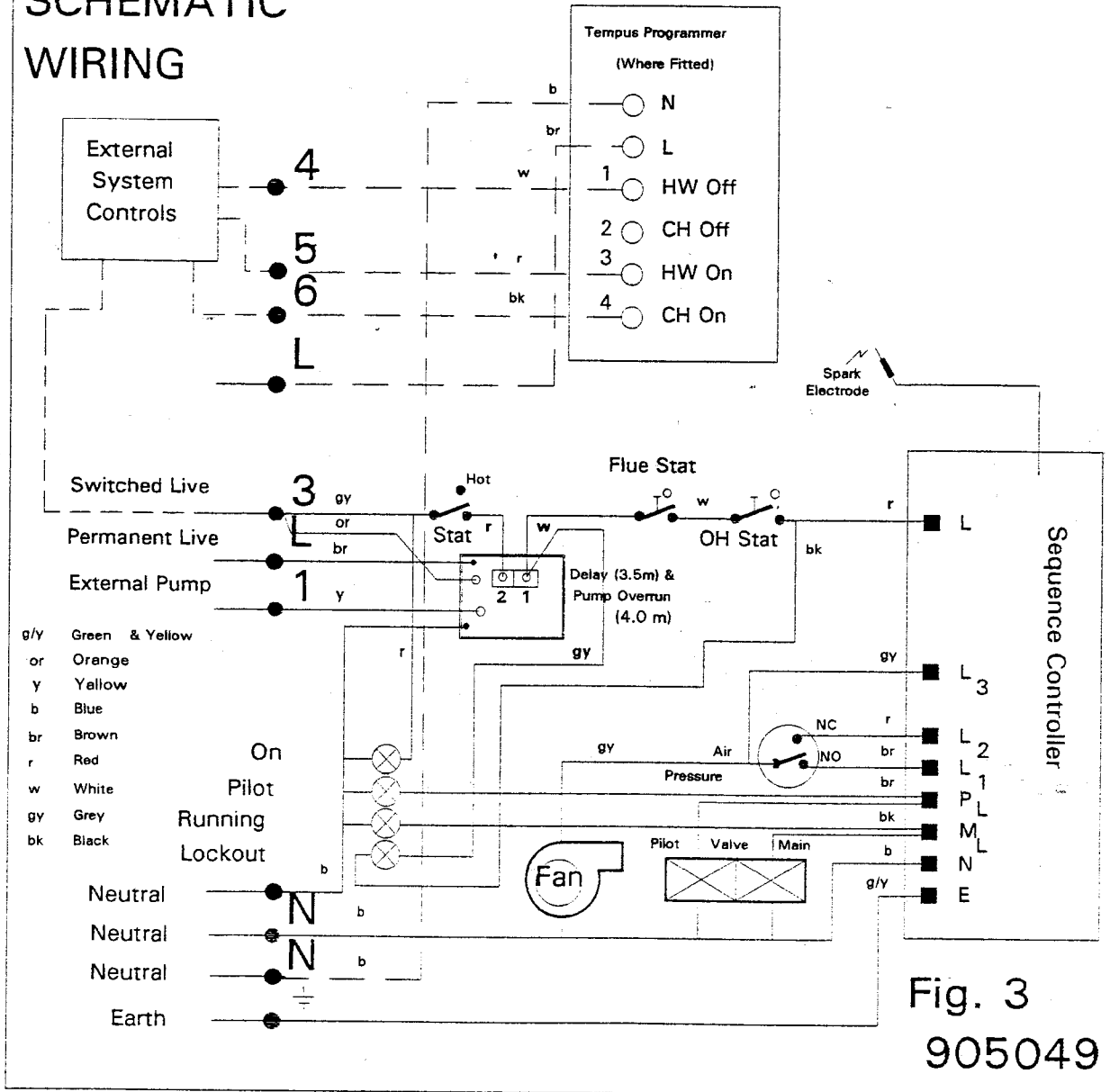

Fig. 3
905049

FUNCTIONAL FLOW DIAGRAM

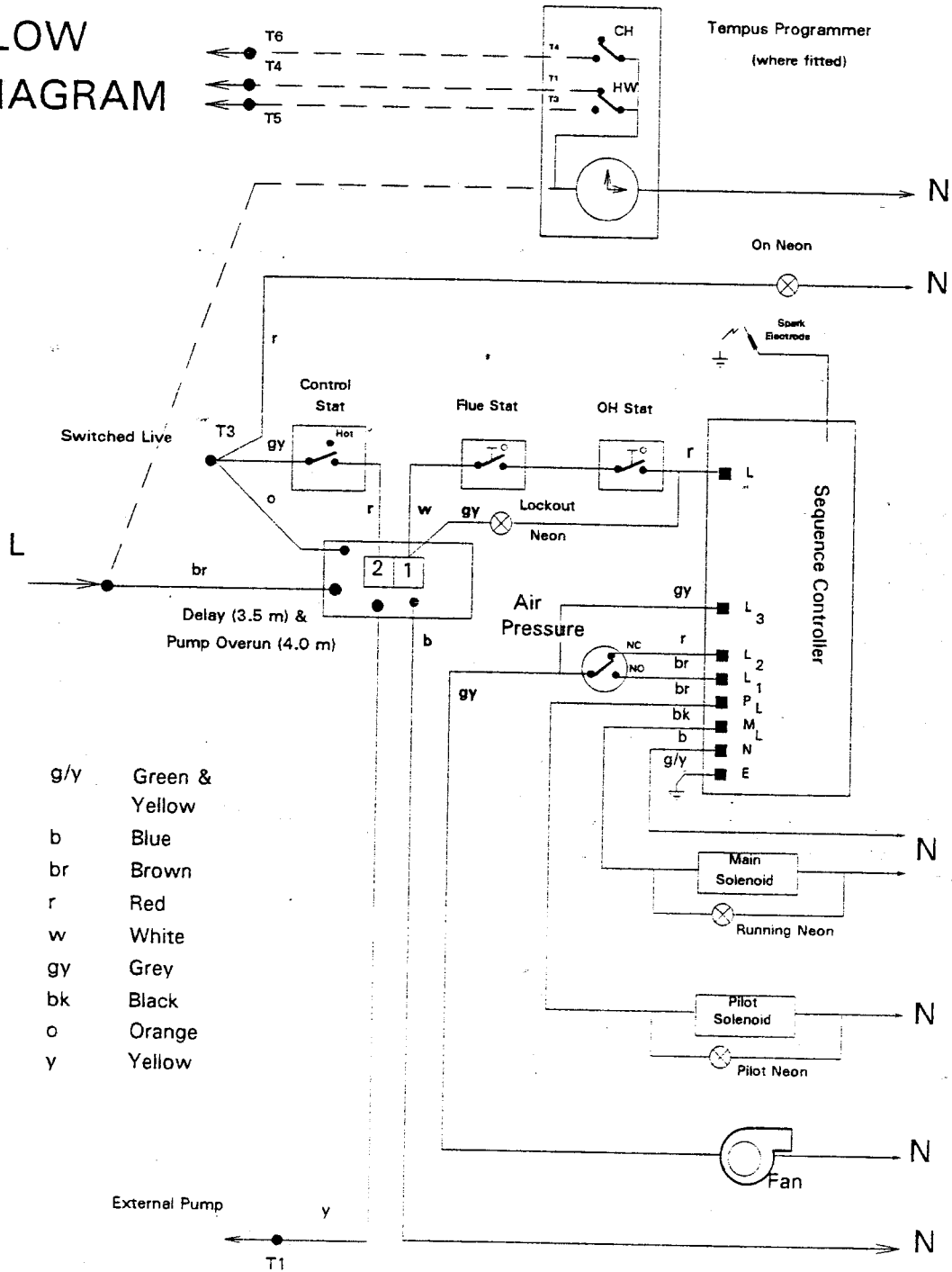

Fig. 4

905049

PHYSICAL WIRING

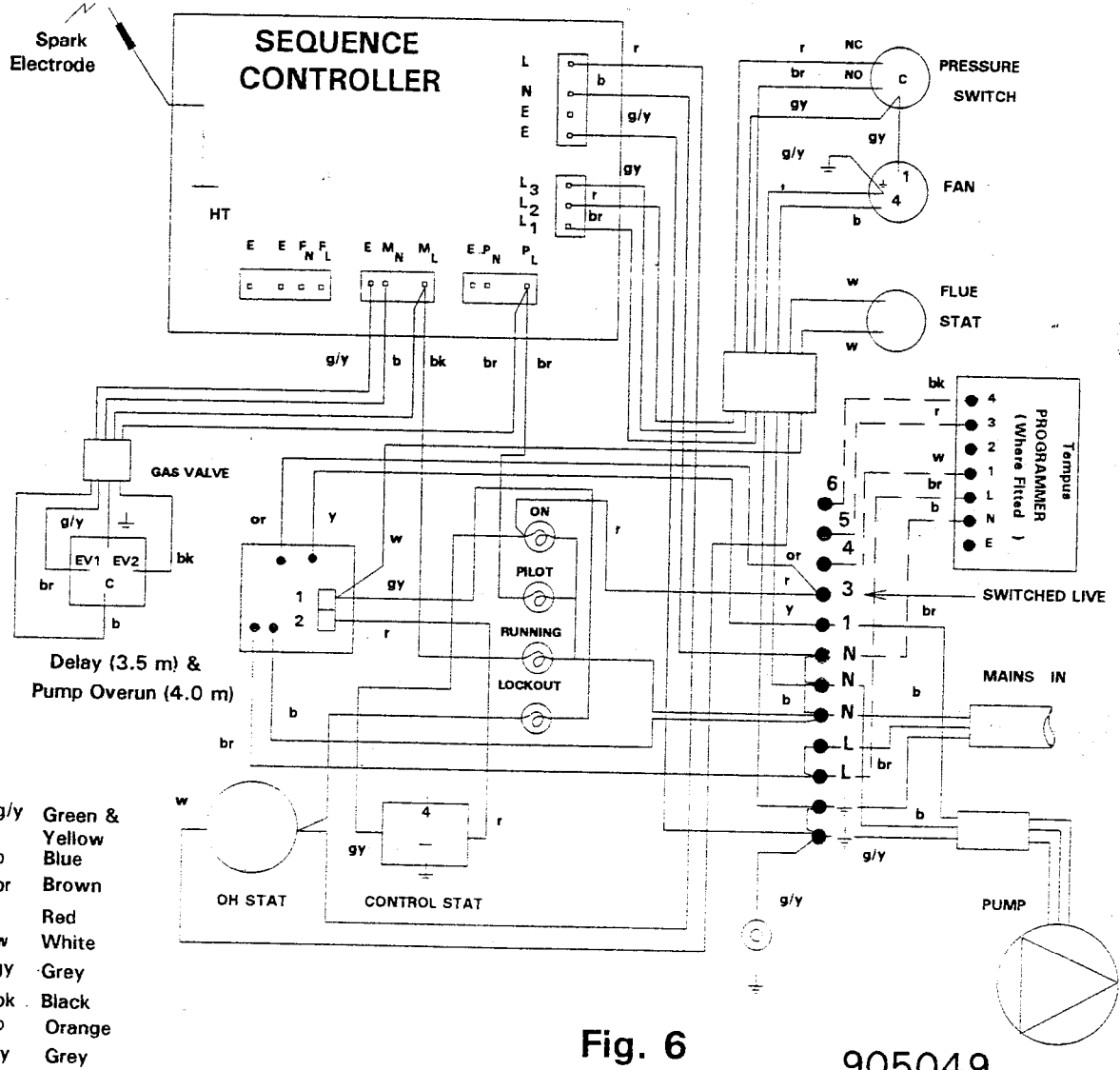
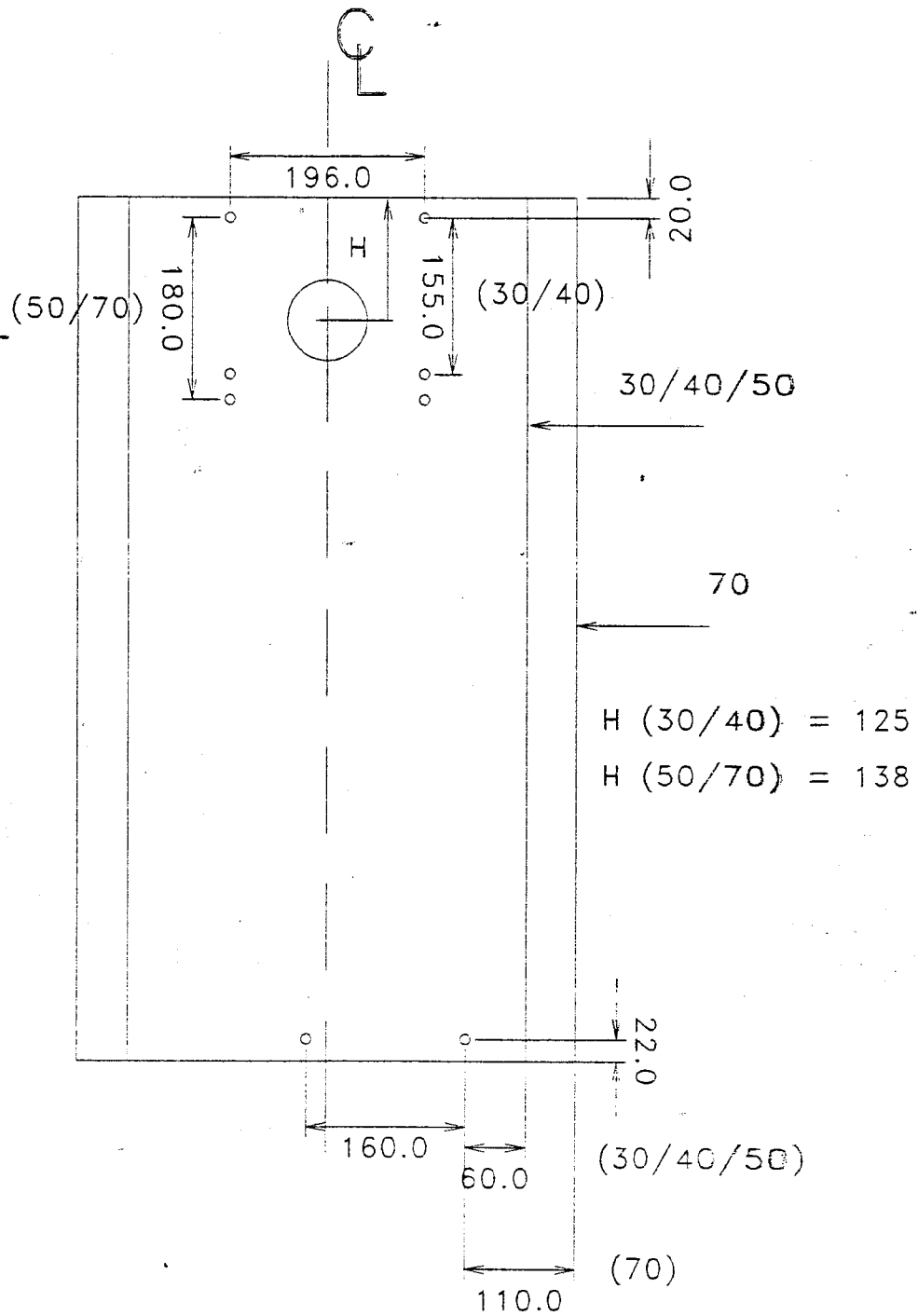

Fig. 6

905049

FIXING POSITIONS



903049

Fig. 7

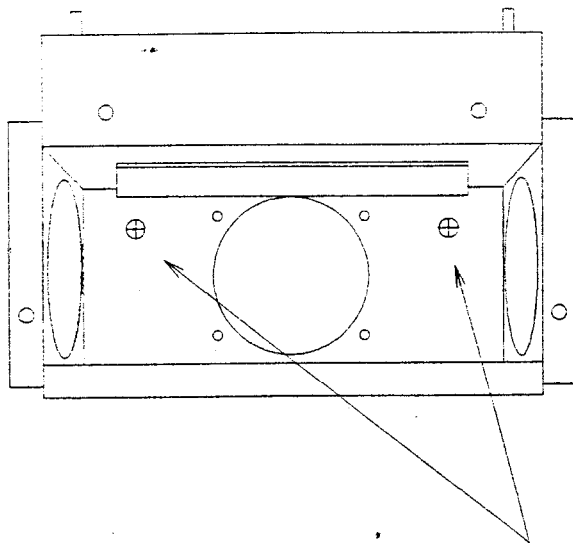

LOCATE TURNING BOX ONTO STUDS AND SCREW TO BRACKET

Fig. 8

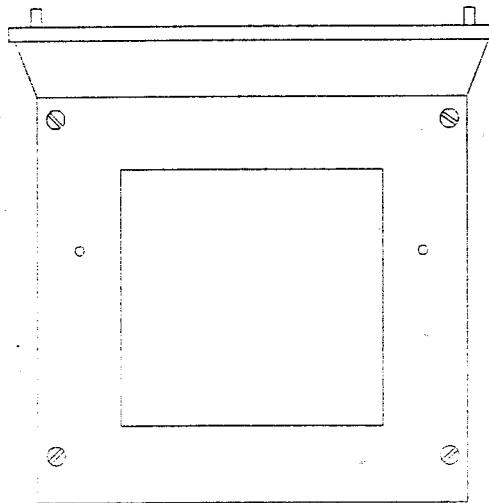

SCREW HANGING BRACKET TO WALL
USING 4 SCREWS AND RAWPLUGS SUPPLIED

207039

Fig. 9

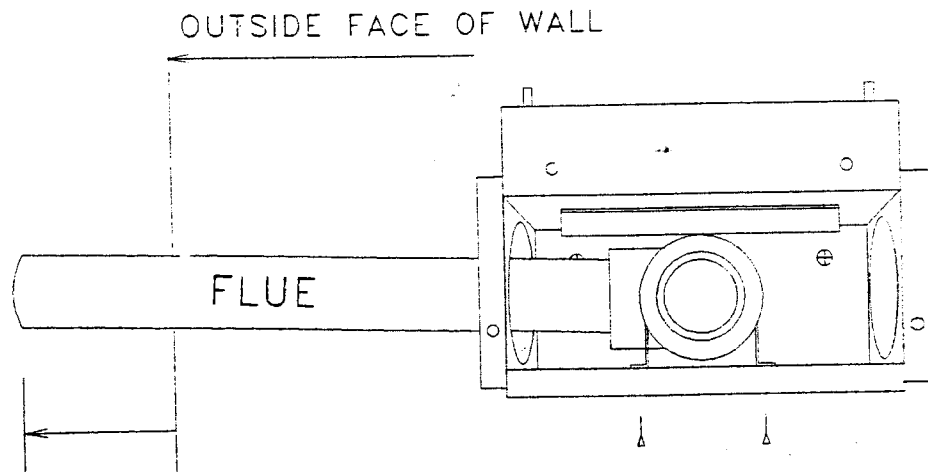

50 mm (2.0") Model 30 & 40
 78 mm (3.0") Model 50 & 70

Fig. 10

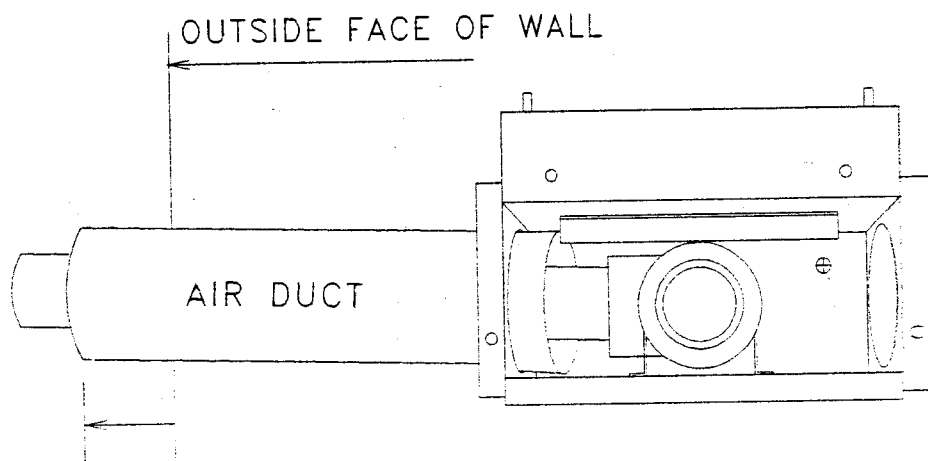

10 mm (0.4") All Models

Fig. 11

903039

FAULT FINDING

General Information

The electrical sequence in the boiler is very straight forward and faults can easily be tracked down if this simple sequence is followed.

Systemcontrols-----ControlStat-----FlueStat-----OverheatStat-----PressureSwitch-----Ignition

The lamps on the front panel indicate several of the stages in the ignition sequence.

When the system controls and the programmer are calling for heat, power is fed to the boiler initiating the following sequence.

Mains voltage appears at terminal 3. and the ON lamp is illuminated. Provided the flue, overheat and control thermostat are all closed (cold), the fan starts up, the pressure switch detects the correct airflow and that the condensate drain is not blocked then, switches over.

The PILOT lamp illuminates, the pilot gas valve opens and the sequence board provides a spark at the pilot electrode.

The pilot flame is detected and the sequence board energises the main gas valve and the RUNNING lamp is illuminated.

The pilot flame lights the burner, and it stays alight until turned off by the control thermostat, a safety thermostat (in the case of a fault condition) or by the system controls).

The flue thermostat will trip if the flue exceeds a preset temperature, the LOCKOUT lamp will illuminate.

The overheat thermostat will trip if the water flow rate is insufficient, the LOCKOUT lamp will illuminate.

NOTE: The boiler has a built-in delay timer that only operates on the Control Thermostat cycles, it does not delay requests to fire from the System Controls. An indicator on the Pump Overrun board shows when the delay is in operation.

WARNING: BEFORE COMMENCING OR COMPLETING ANY ELECTRICAL WORK ON THE APPLIANCE, IT IS RECOMMENDED THAT THE BASIC SAFETY CHECKS FOR EARTH CONTINUITY, SHORT CIRCUIT, POLARITY AND RESISTANCE TO EARTH ARE MADE. ALL WORK CARRIED OUT SHOULD FOLLOW GUIDELINES LAID DOWN BY THE IEE.

Fault Finding Flow Chart

The Flow chart that follows assumes that the system controls are calling for heat and that the boiler temperature is colder than the Control Thermostat setting, and should therefore be firing. For clarity this chart has been printed on the full page following, the rest of this page is intentionally left blank.

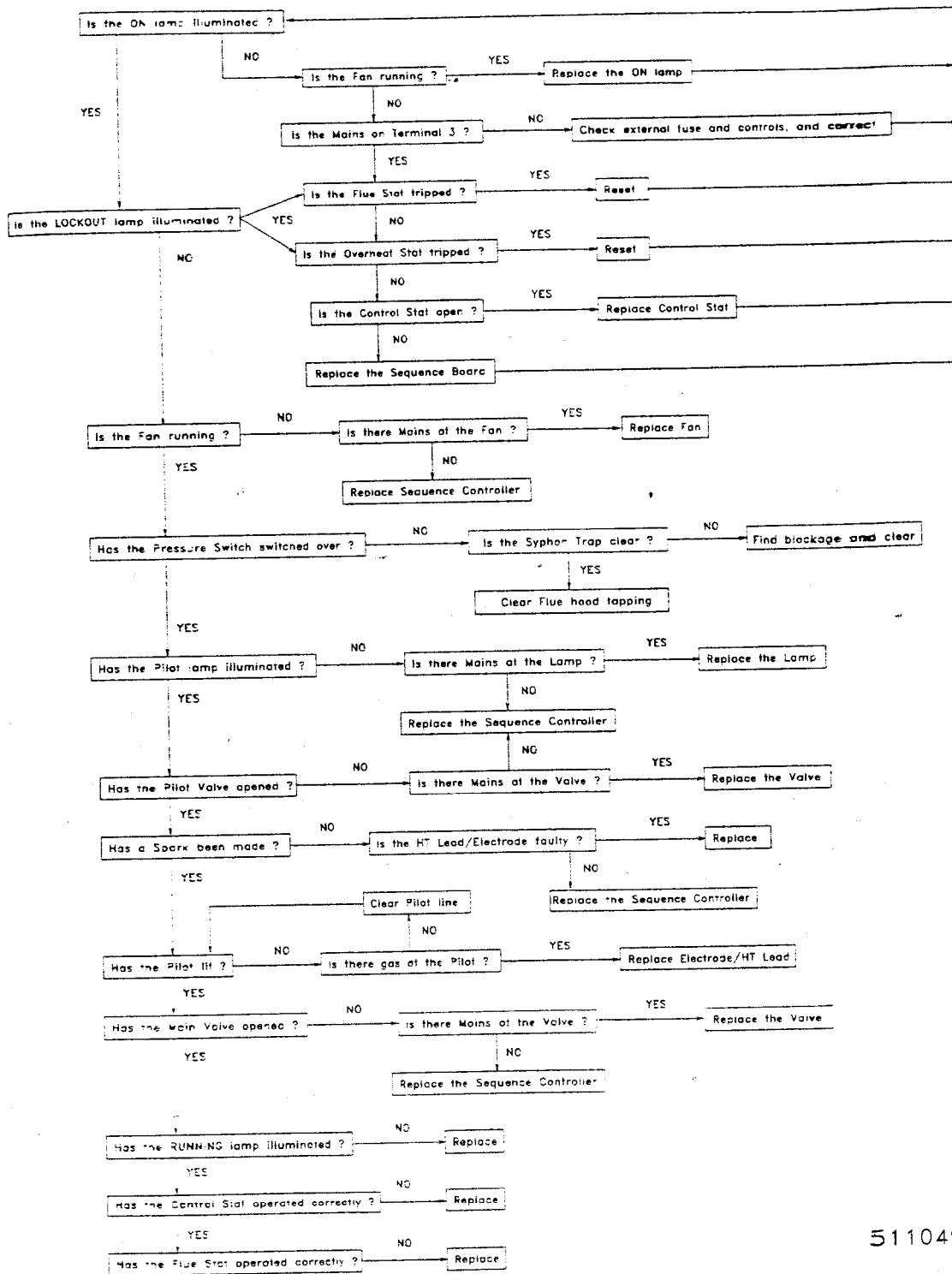

511049

SERVICING

Health and Safety Statement :

This product contains no asbestos.

The Secondary Heat Exchanger is insulated with a small amount of glassfibre, when handling wear gloves and avoid breathing any dust.

Routine

To ensure continued efficient operation of the appliance it is recommended that it is checked and serviced, if necessary, at regular intervals. The frequency of servicing will depend upon the particular installation and usage but in general once per year should be adequate. It is law that any service work should be carried out by Corgi registered personnel.

1. Clean burner and combustion chamber.
2. Check pilot and burner gas supply
3. Check condition of sensing probe.
4. Check boiler pipework joints for leaks.
5. Check condensate pipework for leaks.
6. Check heat exchangers, flue and air duct are clear of any obstruction, and not leaking.
7. Check and clear the condensate exit on the secondary heat exchanger.
8. Check and clear the condensate syphon.

Follow the procedures given in Changing Components for parts removal in addition to the following notes.

1. Heat Exchangers

Remove the panel in front of the secondary heat exchanger to gain access to inner inspection panels on the secondary and to view the primary (the lowest inspection panel also gives a view of the primary). Also view from beneath the primary. Clean as required. If in doubt, drain the system and remove for inspection.

2. Condensate Syphon

With a suitable bowl to catch the water, unscrew the two drain-caps on the underside of the Syphon trap and drain the water. Remove any solids and replace caps. (Fig. 14)

CHANGING COMPONENTS

THERE ARE NO REPAIRABLE ITEMS, IF NOT WORKING AN ITEM MUST BE REPLACED.

The boiler is in two major sections, the Case, and the Electrical Tray, The Major Components Diagram shows where the items are to be found.

Behind the Electrical Tray

1. Sequence Controller.
2. Panel Indicators.
3. Multifunctional Control.
4. Programmer (where fitted).
5. Pump overrun board.

Behind the Case

6. Fan.
7. Air Pressure Switch.
8. Flue Thermostat.
9. Control Thermostat.
10. Overheat Cut-off Device.
11. HT Lead.
12. Pilot Assembly.
13. Burner.
14. Main Injector.
15. Combustion Chamber Insulation.
16. Primary Heat Exchanger.
17. Secondary Heat Exchanger.

Servicing behind the Electrical Tray

To Remove the Electrical tray

- Disconnect the electrical supply from the boiler and system.
- Undo the two screws on the front fascia.
- Slide the Electrical Tray forward a short way, then lower. Remove the cover over the components.

DO NOT STRAIN THE CABLES, USE THE SUPPORT PROVIDED.

1. Sequence Controller

- Remove the Electrical Tray.
- Remove the single screw that retains the inner cover.
- Prise off the multiway connector away from the Sequence Controller.
- Pull off the HT Lead from the Controller.
- Remove the Control Thermostat knob.

- Undo the two M4 screws left and right of the thermostat shaft.
- Undo the single M5 screw beside the 12 way electrical terminal.
- Lift the Chassis and expose the four M5 screws beneath the Sequence Controller and remove them.
- Replace the Sequence Controller.
- Reassembly is the reverse.
- Check the Flame Supervision drop out by lighting the boiler, putting a voltmeter across the Pilot solenoid and then turning off the gas cock. The valve should shut in less than ONE second.

2. Panel Indicators

- Remove the Electrical Tray.
- Remove the single screw that retains the inner cover
- Pull off the electrical terminals from the faulty Indicator.
- Remove the Control Thermostat knob.
- Undo the two M4 screws left and right of the thermostat shaft.
- Undo the single M5 screw beside the 12 way electrical terminal and move the Chassis back.
- Slide the Indicator forward out of the Chassis, and slide in a replacement.
- Reassembly is the reverse.

3. Multifunctional Control

- Remove the Electrical Tray.
- Turn the Gas Cock off.
- Pull off the electrical connector from the Multifunctional Control.
- Release the pilot feed tube.
- Undo the four shoulder bolts at each end of the valve.

TAKE CARE TO SUPPORT THE VALVE AS IT IS RELEASED.

- Replacement is the reverse.
- When secure, attach a manometer to the burner pressure tapping on the right hand side of the valve.
- Turn on gas and electrical supply.
- The gas valve opens in two steps, the first low-rate step can be adjusted to the required 8 mBar in the following manner.
- Remove the plug from 'Port B'. With a finger sealing 'Port B', start boiler and observe pressure, adjust with 'Step opening adjuster'.

Note: The step opening action takes 20 seconds to reset after each operation.

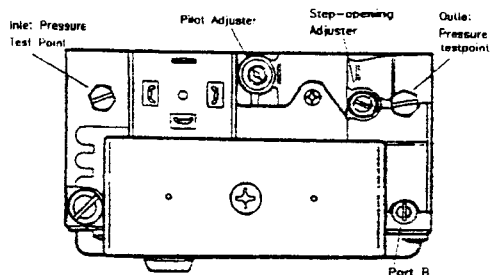

Fig. 12

4. Programmer (when factory fitted)

- Remove the Electrical Tray.
- Tip the Electrical Tray forward to allow access to the two M5 screws above the programmer.
- Undo these screws and remove engagement plate.
- Lift out programmer and release it from its backplate by the two screws in the bottom of the programmer.
- Reassembly is the reverse.
- (Make certain the engagement plate fits the slot in the programmer before securing it with the two M5 screws.)

5. Pump Overrun Board

- Remove the Electrical Tray.
- Remove the single screw that retains the inner cover
- Release the board from the chassis by squeezing the supports whilst lifting the board.
- Disconnect each lead in turn, whilst connecting up the same lead from the new board.
- Push the new board onto its supports.
- Reassembly is the reverse.

Removing the Case

- Remove the Electrical Tray but not the inner cover.
- Undo the two M5 screws at the base of the Case.
- Lift the Case straight up about half an inch (12mm).
- Gently pull the Case straight forward off the hidden studs at the top of the boiler. (The cover hangs on two studs in keyhole slots)
- Place the Case down somewhere safe from damage

6. Fan Assembly

- Remove the Electrical Tray.
- Remove the Case.
- Undo the two M5 screws holding the Fan Protection Hoop and remove.
- Pull the electrical connectors off the Fan.
- Gently pull the pressure tubing off the taping on the Flue Hood.
- Undo the two screws holding the Flue Hood and lift away.
- Reassembly is the reverse.

7. Air Pressure Switch

- Remove the Electrical Tray.
- Remove the Case.
- Pull the electrical connectors off the Air Pressure Switch.
- Gently pull the pressure tubing off the both tappings on the switch.
- Undo the two M4 screws holding the Air Pressure Switch to its bracket on to the Back Panel and lift away.

8. Flue Thermostat

- Remove the Electrical Tray.
- Remove the Case.
- Pull the electrical connectors off the Flue Thermostat.
- Reassembly is the reverse.

9. Control Thermostat

- Remove the Electrical Tray.
- Remove the single screw that holds the inner cover.
- Remove the Case.
- Pull the electrical connectors off the Control Thermostat.
- Pull off the Control Thermostat Knob.
- Undo the two M4 screws beneath the Knob.
- Remove the retaining clip from the Thermostat Pocket.
- Release the capillary retaining clamp where it exits the case.
- Pull the Control Thermostat phial out of its pocket and lift away.
- Reassembly is the reverse.

10. Overheat Cut-off Device

- Remove the Electrical Tray.
- Remove the single screw that retains the inner cover
- Remove the Case.
- Undo the terminals of the Overheat Cut-off Device in the 12 way electrical terminal.
- Pull off the Control Thermostat Knob then undo the two M4 screws left and right of the thermostat shaft and undo the single M5 screw beside the 12 way electrical terminal.
- Carefully lift the Chassis to expose the nut holding the Overheat Cut-off Device
- Remove the retaining clip from the Thermostat Pocket.
- Release the phial retaining clamp where it exits the case.
- Pull the Overheat Cut-off Device phial out of its pocket and lift away.
- Reassembly is the reverse.

11. Electrode and HT Lead

- Remove the Electrical Tray.
- Remove the single screw that holds the inner cover.
- Remove the Case.
- Undo the left and right screws holding the Front Burner Baffle.
- Remove the front baffle.
- Release the tube nut holding the electrode to the Pilot Burner.
- Pull off the HT Lead from the Sequence Controller.
- Carefully withdraw the Electrode and HT Lead.
- Reassembly is the reverse.

12. Pilot Assembly

- Remove the Electrical Tray.
- Remove the Case.
- Undo the left and right screws holding the Front Burner Baffle and remove. If access is restricted also remove the right hand baffle.
- Release the tube nut holding the electrode to the Pilot Burner.
- Undo the Pilot gas tube from the Pilot Assembly and gently lever downwards away from the Pilot.
- Undo the two screws retaining the Pilot Assembly.
- Reassembly is the reverse
- NB The pilot is **not** adjustable.

13. Burner

- Remove the Electrical Tray.
- Remove the Case.
- Undo the Pilot Assembly and gently lever downwards.
- Remove the Combustion Chamber front by releasing the four M5 screws.
- Remove the nut on the front of the burner.
- Pull the Burner forward off the two studs at the rear.
- Reassembly is the reverse.

14. Main Injector

- Remove the Electrical Tray.
- Remove the Case.
- Remove the Burner.
- Undo the Main Injector from the manifold.
- Reassembly is the reverse.

15. Combustion Chamber Insulation

- Remove the Electrical Tray.
- Remove the Case.
- Remove the baffles by releasing the two self tapping screws and the nut at the front, and the four M5 screws holding them on to the Back Panel
- Remove the Burner.
- Undo the four M5 screws in the front Insulation Panel.
- Undo the four M5 screws holding the Chamber to the Back Panel and lower downwards and away.
- Replace the Insulation Panels in the Chamber.
- Reassembly is the reverse.

16. Primary Heat Exchanger

- Remove the Electrical Tray.
- Remove the Case.
- Remove the front baffle.
- Remove or cover the Burner.
- Remove the Combustion Chamber.
- Remove the clip holding the Overheat Phial on the left hand side of the Heat Exchanger and withdraw the phial.
- Drain the Boiler of water.
- Undo the flow and return connections to the Heat Exchanger and lower away.
- Reassembly is the reverse.

17. Secondary Heat Exchanger

- Remove the Electrical Tray.
- Remove the Case.
- Remove the Flue Thermostat.
- Remove the Fan Assembly.
- Drain the Boiler of water.
- Undo the flow and return connections to the secondary Heat Exchanger.
- Release the Condensate connection clamping plate.
- Undo the four M5 screws holding the Secondary Heat Exchanger to the Back Panel and lift away.
- Reassembly is the reverse.

SPARES

1st Line Spares:

Item	Part No	GC Number	Key
Burner (30) Lpg	0557		1
Burner (40 & 50) Lpg	0558		1A
Burner (70) Lpg	0559		1B
Ceramic Board Set (30 40 50)	0524	106 403	2A
Ceramic Board Front (70)	0525	106 404	2B
Flue Hood Gasket	7705	106 381	3
Fan Assembly (30 40 50)	7706	106 382	4
Fan Assembly (70)	7708	106 383	4A
Sequence Controller	7707	378 132	5
Pilot Injector Lpg	0556		6
Electrode	7710	386 744	7
Gas Valve	7711	386 674	8
Air Pressure Switch	7712	379 091	9
Main Injector (1.6 mm) (30) Lpg	0563		10
Main Injector (1.8 mm) (40) Lpg	0564		10A
Main Injector (2.2 mm) (50) Lpg	0565		10B
Main Injector (2.4 mm) (70) Lpg	0566	10C	
Overheat Thermostat	7715	379 314	11
Pilot Assembly	7716	381 865	12
Flue Thermostat	7717	379 308	13
Control Thermostat	7718	379 307	14
Pump Overrun Board	7377		15
HT Lead	7729	382 934	16

ELECTRICAL COMPONENTS

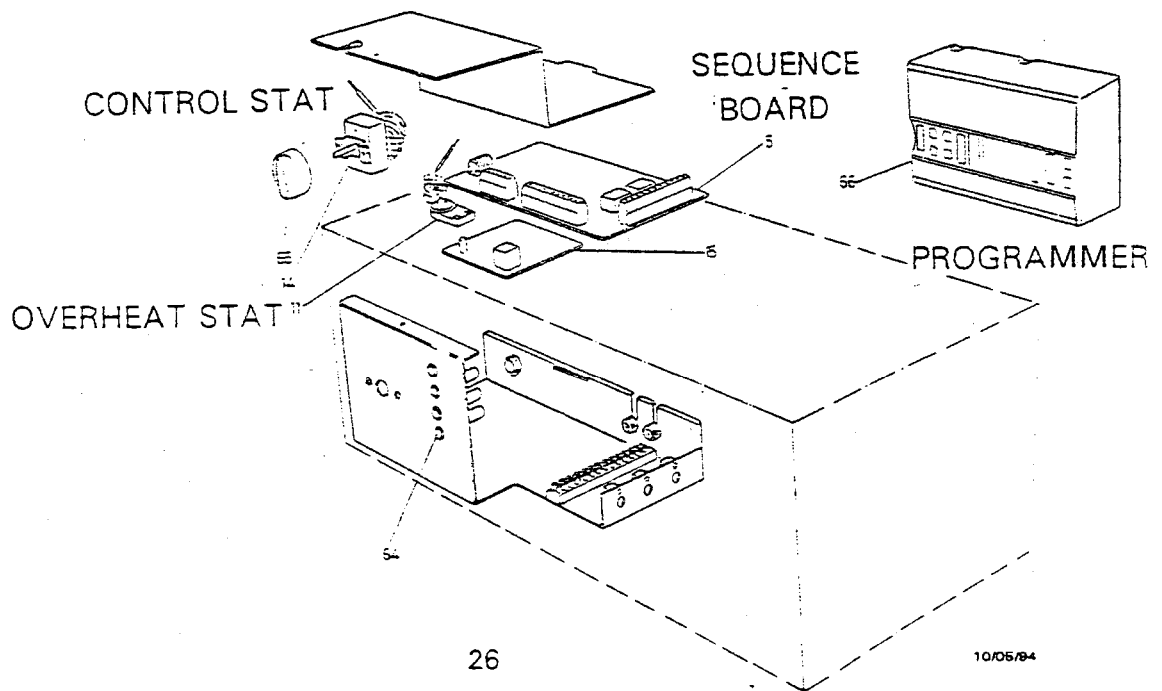

LPG

26

10/05/84

MAJOR COMPONENTS

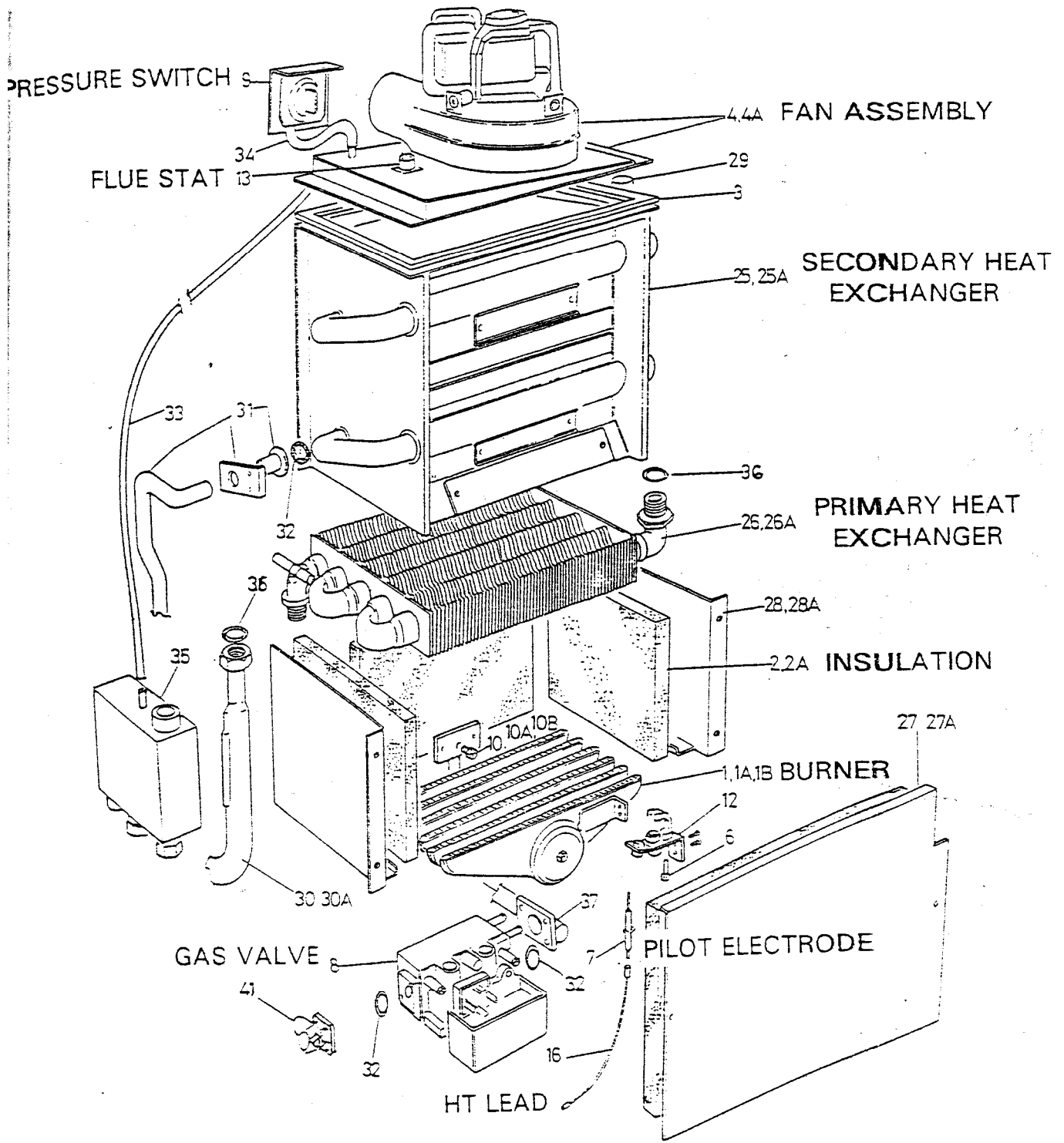

LPG

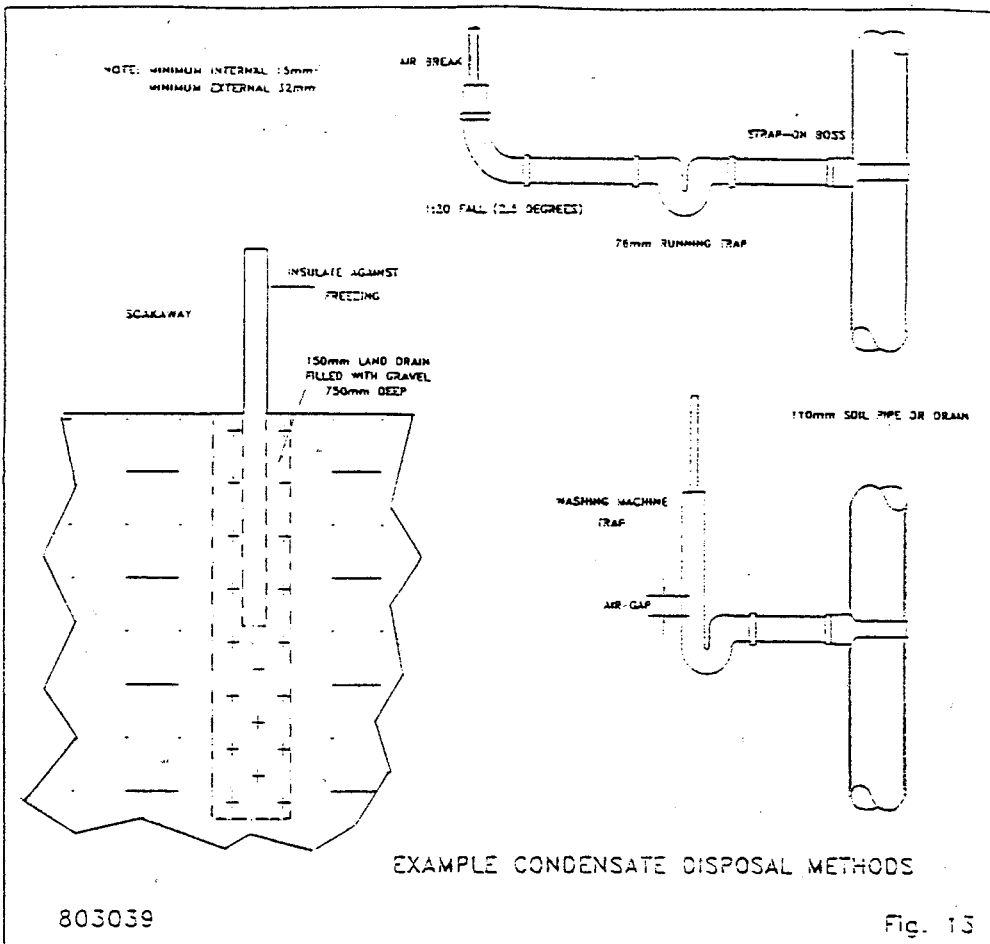

803039

Fig. 13

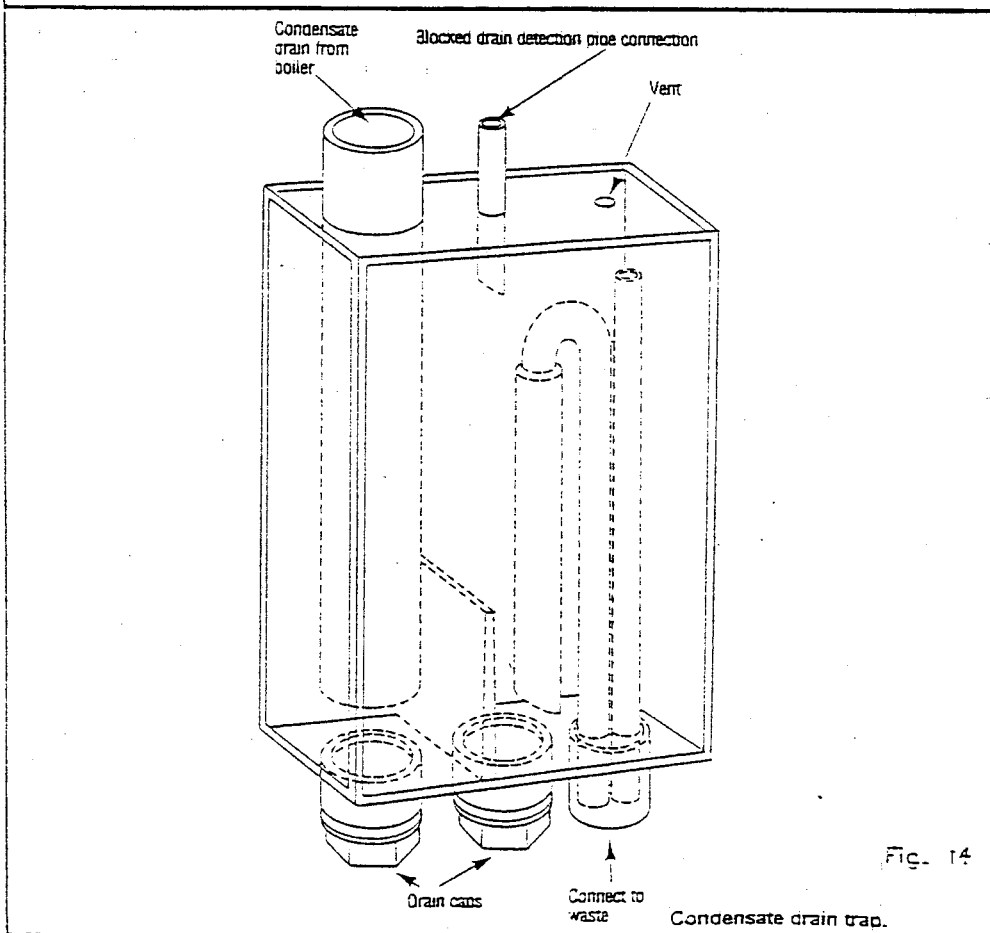

Fig. 14

LPG