

**SCT**

**80-115**

**80-140**

**80-180**

**95-199**

**95-260**

**70-360**

**65-400**

**Installation  
User and  
Service Manual**



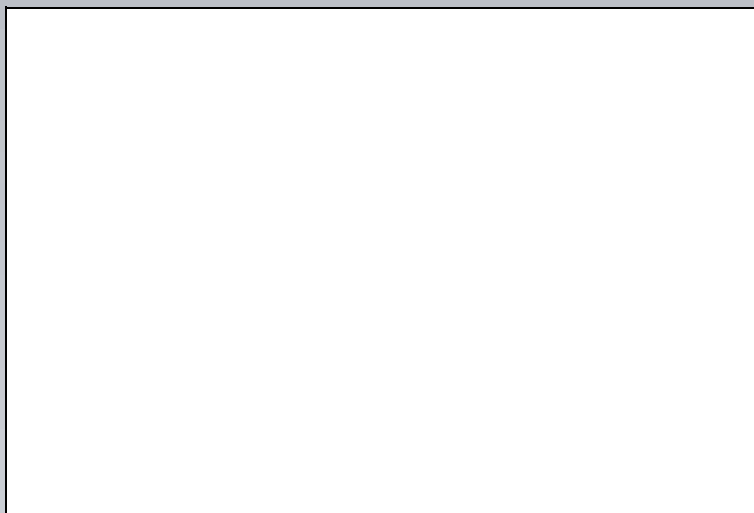

**your installer**

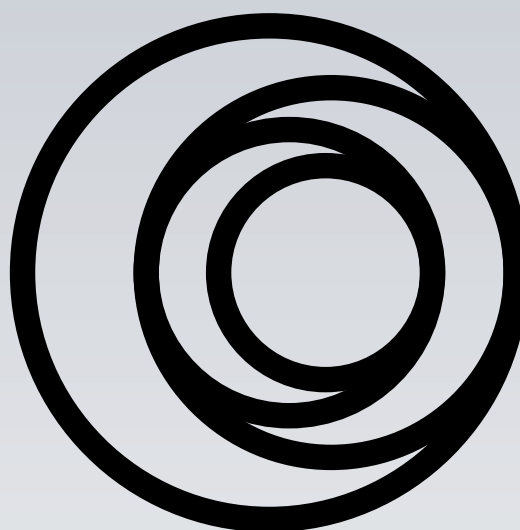

**state**



*The Expert's Choice™*

---

** Warning**

Read this manual carefully before first using the water heater. Failure to read this manual and to follow the instructions in this manual may lead to accidents, personal injury, and damage to the appliance.

---

**Copyright****Copyright 2003 State Water Heaters**

All rights reserved.

Nothing from this publication may be copied, reproduced and/or published by means of printing, photocopying or by whatsoever means, without the prior written approval of State Water Heaters.

State Water Heaters reserves the right to modify specifications stated in this manual.

**Trademarks**

Any brand names mentioned in this manual are registered trademarks of their respective owners.

**Liability**

State Water Heaters accepts no liability for claims from third parties arising from improper use other than that stated in this manual and in accordance with the General Conditions registered at the Eindhoven Chamber of Commerce.

Refer further to the General Conditions. These are available on request, and without charge.

Although considerable care has been taken to ensure a correct and suitably comprehensive description of all relevant components, the manual may nonetheless contain errors and inaccuracies.

Should you detect any errors or inaccuracies in the manual, we would be grateful to receive notification. This helps us to further improve our documentation.

**More information**

If you have any comments or queries concerning any aspect related to the appliance, then please do not hesitate to contact State Water Heaters.

Aquaheat State Sales  
Orchard House, 61-67 Commercial Road  
Southampton SO15 1GG

Tel.: 023 8057 1107

Fax: 023 8057 7965

E-mail: [enquiries@state-waterheaters.co.uk](mailto:enquiries@state-waterheaters.co.uk)

In the event of problems with connecting to the gas, electricity or water supply, please contact your installation's supplier/installer.





# Table of contents

<b>1</b>	<b>Introduction</b>	<b>9</b>
1.1	About the appliance	9
1.2	What to do if you smell gas-	9
1.3	Regulations	9
1.4	Target groups	10
1.5	Maintenance-	10
1.6	Forms of notation	11
1.7	Overview of this document	11
<b>2</b>	<b>Functioning of the appliance-</b>	<b>13</b>
2.1	Introduction	13
2.2	Functional description of the appliance	14
2.3	Heating cycle of the appliance	15
2.4	Protection for the appliance	15
2.4.1	Gas control	15
2.4.2	Thermocouple-	15
2.4.3	Water temperature protection	16
2.4.4	Flue gas backflow safeguard	16
2.5	Safety of the installation	16
2.5.1	Unvented installation (sealed)	16
2.5.2	Vented installation (open)	17
2.5.3	T&P valve-	17
<b>3</b>	<b>Installation</b>	<b>19</b>
3.1	Introduction	19
3.2	Packaging	21
3.3	Environmental conditions-	21
3.3.1	Working clearances	21
3.3.2	Humidity and ambient temperature-	21
3.3.3	Maximum floor loading	22
3.3.4	Water composition	22
3.4	Technical specifications	22
3.5	Installation diagrams	24
3.6	Water connections Unvented-	26
3.6.1	Cold water side	26
3.6.2	Shunt pipe	26
3.6.3	Hot water side-	26
3.6.4	Drain valve	26
3.6.5	Circulation pipe	27
3.7	Water connections Vented	27
3.7.1	Cold water side	27
3.7.2	Shunt pipe	27
3.7.3	Hot water side-	27
3.7.4	Circulation pipe	27
3.8	Gas connection	28
3.9	Flue gas discharge-	28
3.9.1	Introduction	29
3.9.2	Fitting the draught diverter-	29
3.9.3	Flue gas thermostat assembly	30

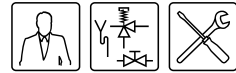

3.10	Electrical connection	- - - - -	31
3.10.1	Introduction	- - - - -	31
3.10.2	Mains power	- - - - -	32
3.10.3	Week timer circuit	- - - - -	32
3.11	Conversion to a different gas category	- - - - -	32
3.11.1	Introduction	- - - - -	33
3.11.2	Conversion to a different gas category	- - - - -	33
3.12	Checking the supply pressure and burner pressure	- - - - -	35
<b>4</b>	<b>Filling and draining</b>	- - - - -	<b>39</b>
4.1	Introduction	- - - - -	39
4.2	Filling the appliance	- - - - -	40
4.2.1	Filling unvented installations	- - - - -	40
4.2.2	Filling vented installations	- - - - -	40
4.3	Draining the appliance	- - - - -	40
4.3.1	Draining unvented installations	- - - - -	40
4.3.2	Draining vented installations	- - - - -	41
<b>5</b>	<b>Controls</b>	- - - - -	<b>43</b>
5.1	Introduction	- - - - -	43
5.2	Control panel	- - - - -	43
5.3	Explanation of the icons	- - - - -	44
5.4	I/O/II-switch	- - - - -	44
5.5	Control thermostat	- - - - -	44
5.6	Week timer circuit	- - - - -	44
5.7	Flue gas backflow safeguard reset button	- - - - -	45
<b>6</b>	<b>Status of the appliance</b>	- - - - -	<b>47</b>
6.1	Introduction	- - - - -	47
6.2	Operating states	- - - - -	47
6.3	Power Anode Status	- - - - -	47
6.4	Error states	- - - - -	48
<b>7</b>	<b>Starting up and shutting down</b>	- - - - -	<b>49</b>
7.1	Introduction	- - - - -	49
7.2	Starting up	- - - - -	49
7.3	Shutting down	- - - - -	50
7.3.1	Shutting the appliance down for brief periods ("OFF mode")	- - - - -	50
7.3.2	Disconnecting the appliance from the mains	- - - - -	50
7.3.3	Shutting the appliance down for a longer period	- - - - -	50
7.4	The appliance's heating cycle	- - - - -	50
<b>8</b>	<b>Troubleshooting</b>	- - - - -	<b>53</b>
8.1	Introduction	- - - - -	53
8.2	Troubleshooting table for general errors	- - - - -	54
8.3	Troubleshooting table 'no hot water'	- - - - -	56
8.4	Troubleshooting table 'insufficient hot water'	- - - - -	57
<b>9</b>	<b>Maintenance</b>	- - - - -	<b>59</b>
9.1	Introduction	- - - - -	59
9.2	Preparing for maintenance	- - - - -	59



9.3	Water-side maintenance - - - - -	59
9.3.1	Introduction - - - - -	59
9.3.2	Checking the anodes - - - - -	59
9.3.3	Descaling and cleaning the tank - - - - -	60
9.4	Gas-side maintenance - - - - -	60
9.4.1	Introduction - - - - -	60
9.4.2	Cleaning the burners - - - - -	60
9.4.3	Cleaning the injectors - - - - -	61
9.4.4	Checking the flue baffles - - - - -	61
9.5	Finalising maintenance- - - - -	61
<b>10</b>	<b>Warranty (Certificate)- - - - -</b>	<b>63</b>
10.1	General warranty - - - - -	63
10.2	Tank warranty - - - - -	63
10.3	Installation and conditions of use - - - - -	63
10.4	Exclusions - - - - -	63
10.5	Scope of the warranty - - - - -	64
10.6	Claims - - - - -	64
10.7	Limitation of liability - - - - -	64
<b>A</b>	<b>SCT electrical diagram - - - - -</b>	<b>65</b>
<b>IX</b>	<b>Index - - - - -</b>	<b>67</b>

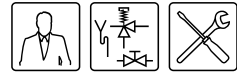



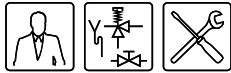

# 1 Introduction

## 1.1 About the appliance

This manual describes how to install, service and use an SCT-appliance. An SCT appliance is a gas-fired open water heater without a fan. The SCT-appliance is fitted with a flue gas backflow safeguard and falls into the appliance category B11BS. This information is located on the appliance's identification plate. The information in this manual is applicable to types SCT: 80-115, 80-140, 80-180, 95-199, 95-260, 70-360, 65-400.

The construction and fittings of each appliance conform to the European standard for gas-fired storage water heaters for sanitary use (EN 89). The appliances are therefore compliant with the European Directive on Gas Appliances and thereby authorised to bear the CE mark.



---

### Warning

Read this manual carefully before commissioning the water heater. Failure to read the manual and to follow the printed instructions may lead to personal injury and damage to the appliance.

---

## 1.2 What to do if you smell gas

---

### Warning

Whenever there is a **smell of gas**:

No naked flames! No smoking!

Avoid causing sparks! Do not use any electrical equipment or switch, i.e. no telephones, plugs or bells!

Shut off the mains gas supply!

Open windows and doors!

Warn occupants and leave the building!

After leaving the building, alert the gas distribution company or installer.

---

## 1.3 Regulations

As the (end) user, installer or service and maintenance engineer, you must be certain that the complete installation as a minimum complies with the official local:

- building regulations;
- energy supplier's directives for existing gas installations;
- directives and technical guidelines for natural gas installations;
- safety requirements for low-voltage installations;
- regulations governing the supply of drinking water;
- regulations governing ventilation in buildings;
- regulations governing the supply of air for combustion;
- regulations governing the removal of products of combustion;
- requirements for installations that consume gas;
- regulations governing indoor waste water disposal;
- regulations imposed by fire service, power companies and municipality.



Furthermore, the installation must comply with the manufacturer's regulations.

**Note**

Later amendments and/or additions to all regulations, requirements and guidelines published on or prior to the moment of installing, will apply to the installation.



**1.4 Target groups**

The three target groups for this manual are:

- (end) users;
- installers;
- service engineers.

Symbols on each page indicate the target groups for whom the information is intended. See [Table 1.1](#).

**Table 1.1** Symbols for each target group

Symbol	Target groups
	(End) user
	Installer
	Service and maintenance engineer

**1.5 Maintenance**

A service should be carried out at least once a year, both on the water side and on the gas side. Maintenance frequency depends, among other things, on the water quality, the average burning time per day and the set water temperature.

**Note**

To determine the correct maintenance frequency, it is recommended to arrange for the service engineer to check the appliance on both the water and gas side, three months after installation. Based on this check, the best maintenance frequency can be determined.

**Note**

Regular maintenance extends the service life of the appliance.

Both the end user and the service engineer are responsible for regular maintenance. They will need to establish clear agreements on this.

**Note**

If the appliance is not regularly maintained, the warranty will become void.



**1.6 Forms of notation**

The following notation is used in this manual:

- Note**  
 Important information.
- Caution**  
 Ignoring this information can lead to the appliance being damaged.
- Warning**  
 Failure to carefully read this information may lead to danger of personal injury, and serious damage to the appliance.

**1.7 Overview of this document**

Table 1.2 provides an overview of the contents of this document.

Table 1.2 Content of document

Chapter	Target groups	Description
2 Functioning of the appliance		This chapter describes how the appliance functions.
3 Installation		This chapter describes the installation activity to be completed before you actually start up the appliance. Instructions are also provided for the installation and/or service engineer on converting the appliance to other types of gas.
4 Filling and draining		This chapter describes how to fill and drain the appliance.
5 Controls		This chapter describes the appliance's control panel, and how to use it.
6 Status of the appliance		This chapter describes each status (state) that the appliance may be in, and how to respond, if necessary.
7 Starting up and shutting down		This chapter describes how to start up the appliance, and how to shut it down for a brief or long period of time. The general heating cycle of the appliance is also described.
8 Troubleshooting		This chapter is mainly intended for the installer and the service engineer. It describes appliance errors. These errors are indicated on the display. A table of possible causes and solutions is provided. End users may also refer to this additional information about the appliance.
9 Maintenance		This chapter sets out the maintenance tasks to be carried out during a service.
10 Warranty (Certificate)		This chapter states the warranty terms and conditions.



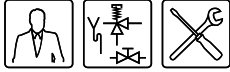

# 2 Functioning of the appliance

## 2.1 Introduction

This chapter successively covers the following topics:

- [Functional description of the appliance](#);
- [Heating cycle of the appliance](#);
- [Protection for the appliance](#);
- [Safety of the installation](#).

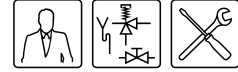

### 2.2 Functional description of the appliance

#### Legend

- ❶ flue gas discharge
- ❷ draught diverter
- ❸ anodes
- ❹ flue tubes
- ❺ flue baffles
- ❻ PU insulation layer
- ❼ tank
- ❽ cleaning opening
- ❾ drain valve
- ❿ combustion chamber
- ⓫ radiation shield/condensation tray
- ⓬ gas control
- ⓭ flue gas thermostat sensor
- ⓮ flue gas thermostat
- ⓯ hot water outlet
- ⓰ safety thermostat sensor
- ⓱ high-limit thermostat sensor
- ⓲ control panel
- ⓳ control thermostat
- ⓴ high-limit thermostat
- ⓵ safety thermostat
- ⓶ control thermostat sensor
- ⓷ thermo-couple
- ⓸ pilot burner
- ⓹ igniter electrode
- ⓺ cold water inlet
- ⓻ piezo igniter
- ⓼ bar burners/burner tray

Figure 2.1 shows a cut-away view of the appliance.

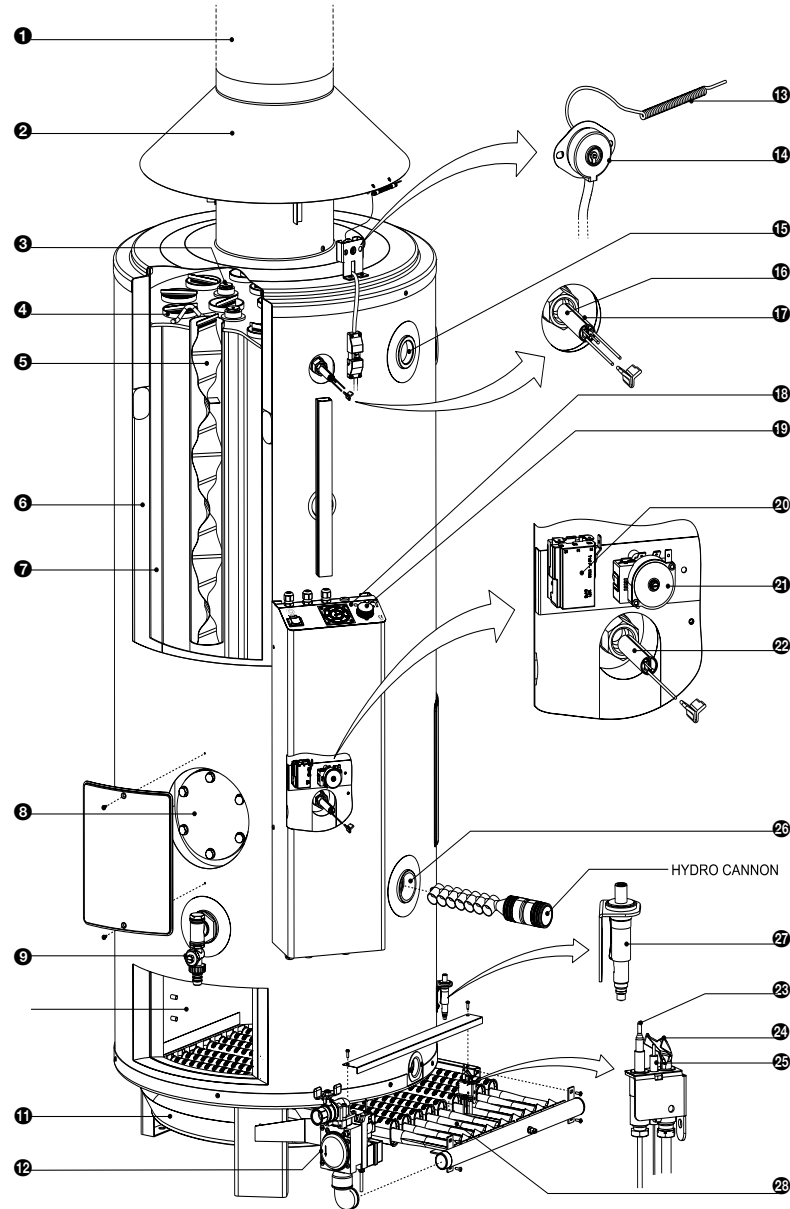

IMD-0144

**Figure 2.1** Cut-away view of the appliance

In this appliance the cold water enters the bottom of the tank via the cold water inlet ❷. The heat of combustion is transferred to the water through the combustion chamber ❿ and flue tubes ❹. The heated tap water leaves the tank through the hot water outlet ⓯. Once the appliance is completely filled with water, it remains constantly under water supply pressure. As hot water from the appliance is consumed, it is continuously replenished with cold water.

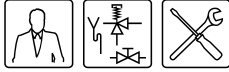

The appliance is fitted with an igniter electrode ⑳ which ignites the pilot burner ㉑. The gas that fuels the combustion flows via the gas control ㉒ into the manifold, in which injectors are located. Via these injectors, the gas enters the bar burners ㉓. Together the bar burners constitute the burner tray. As the gas is injected into the bar burners, the primary air required for combustion is also drawn in<sup>(1)</sup>. Additional air is drawn through the openings in the burner tray. When the gas/air mixture starts to flow, it is ignited by the pilot burner.

The flue gases arising from combustion here are drawn upwards through the flue tubes ㉔. Flue baffles ㉕ are located in the flue tubes. These slow down the flue gas exhaust, improving the heat transfer efficiency. The flue gases leave the appliance via the draught diverter ㉖. A radiation shield/condensation tray ㉗ is fitted under the burner tray. This prevents overheating of the floor surface under the appliance and serves as a collection tray for condensation water.

The PU insulation layer ㉘ prevents heat loss. The inside of the tank is enamelled to protect against corrosion. The anodes ㉙ provide additional protection. The Hydro Cannon also protects the bottom of the tank from scaling.

### 2.3 Heating cycle of the appliance

The entire appliance is regulated by a control thermostat. The control thermostat monitors the water temperature ( $T_{\text{water}}$ ). The appliance's heating cycle is activated as soon as  $T_{\text{water}}$  falls below the specified threshold value ( $T_{\text{set}}$ ). The value for  $T_{\text{set}}$  can be adjusted using the control thermostat ( $\pm 40^{\circ}\text{C} \dots \pm 70^{\circ}\text{C}$ ).

As soon as  $T_{\text{water}}$  drops below  $T_{\text{set}}$  there is a demand for heat, and the control thermostat closes, causing the main valve on the gas control to open. The gas mixes with the air it draws along. This mixture is ignited by the pilot burner and the water becomes heated. As soon as  $T_{\text{water}}$  exceeds  $T_{\text{set}}$ , the heat demand ceases, the thermostat opens again, and the heating cycle stops.

The control thermostat has a certain margin both when closing and opening, referred to as the hysteresis. The hysteresis cannot be adjusted.

### 2.4 Protection for the appliance

The appliance is protected by means of the following:

- the Gas Control
- the Thermocouple
- the Water Temperature Safeguard
- the Flue Gas Backflow Safeguard

#### 2.4.1 Gas control

The gas control has 2 valves for safety purposes:

1. The main valve, which controls the gas supply to the burner tray and which is switched via the I/O/II-switch circuit and the control, high-limit and flue gas thermostats. This circuit is powered by the supply voltage.
2. The safety valve, which controls the gas supply to the pilot burner and which is switched via the thermocouple circuit and the safety thermostat. This circuit is powered by the millivolt potential from the thermocouple that is located in the pilot flame. Whenever the safety valve closes, the main valve also closes.

#### 2.4.2 Thermocouple

1. To prevent gas flowing when there is no combustion, a thermocouple is fitted. As a result of the presence of the (permanent) pilot flame, the thermocouple maintains a millivoltage potential which keeps the gas control's safety valve open.
2. If the pilot flame goes out, this voltage disappears and the gas control's safety valve closes, interrupting the gas supply to the burner tray.

1. The gas flow is accelerated through the narrow opening in the injector. This creates a vacuum, which also draws in air, through the Venturi effect.



### 2.4.3 Water temperature protection

To ensure a safe water temperature is not exceeded, the high-limit thermostat sensor is installed at the top of the appliance. In the event of stratification (“stacking”) of the water temperature, the temperature at the top of the appliance can be considerably higher than the set temperature for the hot water.

In the event that both the control and maximum thermostats should fail, there is also a safety thermostat.

[Table 2.1](#) explains how the high-limit and safety thermostats respond to the sensors.

**Table 2.1** Temperature protection

Protection	Description
High-limit thermostat	If the high-limit thermostat sensor ⑩ detects a temperature greater than 84°C, the high-limit thermostat opens and the gas control's main valve circuit is broken, closing the valve. The heating cycle stops until the high-limit thermostat closes again. At this point the gas control opens again and the heating cycle is repeated. The high-limit protection also prevents excessive scale forming in the appliance.
Safety thermostat	If the safety thermostat sensor ⑪ detects a temperature greater than 93°C, the safety thermostat opens. The gas control's safety valve circuit is broken and the safety and main valve both close. Combustion immediately ceases, and the pilot flame also goes out.  In order to re-start the appliance, the pilot flame must be re-lit.

### 2.4.4 Flue gas backflow safeguard

The flue gases are drawn outside via the draught diverter ② and the flue gas discharge ①. To prevent the flue gases from flowing back into the installation room, the discharge ducting is monitored by a feature called the Thermal Reflux Safeguard (T.R.S.). For this purpose a flue gas thermostat sensor ⑬ complete with flue gas thermostat ⑭ is fitted in the draught diverter. Under normal circumstances this sensor measures the ambient temperature. However, if the chimney is not drawing sufficiently (for example, due to a blockage in the chimney), the flue gases will 'reflux' and flow back past the flue gas thermostat sensor. The sensor then detects an excessive temperature and the flue gas thermostat will open. The circuit of the main valve of the gas control is interrupted and the valve closes, which forces the heating cycle to stop. The flue gas discharge thermostat will be locked out, and the appliance will require a manual reset before it can be re-started.

## 2.5 Safety of the installation

In addition to the standard safety monitoring of the appliance, the appliance must also be protected by an expansion vessel, pressure overflow valve, non-return valve and a T&P valve.

Use of an expansion vessel, a pressure relief valve and/or a pressure reducing valve depends on the type of installation: unvented or vented.

### 2.5.1 Unvented installation (sealed)

With an unvented installation, a pressure relief valve and expansion vessel prevent excessive pressure in the tank. This prevents damage being caused to the enamelled coating (in the appliance) or to the tank. A check valve prevents excessive pressure in the water supply system. This valve also prevents water from flowing backwards from the tank into the cold water supply system. The pressure reducing valve protects the installation against an excessively high water supply pressure (> 8 bar). These components are fitted to the cold water pipe. See paragraph '[3.6.1 Cold water side](#)'.



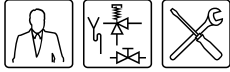

### **2.5.2 Vented installation (open)**

With a vented installation, excess pressure is taken up by the open water reservoir. The level of the water reservoir determines the maximum working pressure in the tank, which may not exceed 8 bar. The installation must also be fitted with an overflow from the hot water pipe that empties into the water reservoir. See paragraph '[3.6.3 Hot water side](#)'.

### **2.5.3 T&P valve**

A T&P valve is only required in "unvented" installations. However, State also recommends the use of a T&P valve in "vented" installations.

A T&P valve monitors the pressure in the tank, and the water temperature at the top of the tank. If the pressure in the tank becomes too high (>10 bar) or the water temperature is too high (>97°C) the valve will open. The hot water will immediately flow out of the tank. Because the appliance is under water supply pressure, cold water will automatically flow into the tank. The valve remains open until the unsafe situation has been averted. The appliance is standard equipped with a connecting point for a T&P valve. See paragraphs '[3.6.3 Hot water side](#)' (Unvented) and '[3.7.3 Hot water side](#)' (Vented).

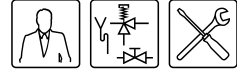



# 3 Installation

---

## Warning

The installation should be carried out by an authorised installation engineer in compliance with the official local regulations imposed by the gas, water and power supply companies and the fire service.

The appliance may only be installed in a room which complies with the requirements stated in national and local ventilation regulations.

See also paragraph '[1.3 Regulations](#)'.

---

### 3.1 Introduction

This chapter describes the installation activities to be carried out before the appliance may be started up, namely:

- [Packaging](#);
- [Environmental conditions](#);
- [Technical specifications](#);
- [Water connections Unvented](#);
- [Water connections Vented](#);
- [Gas connection](#);
- [Flue gas discharge](#);
- [Electrical connection](#);
- [Conversion to a different gas category](#);
- [Checking the supply pressure and burner pressure](#);

---

## Note

Starting up the appliance is described in chapter '[7 Starting up and shutting down](#)'.

---

[Figure 3.1](#) shows a plan and elevation drawing of the appliance.

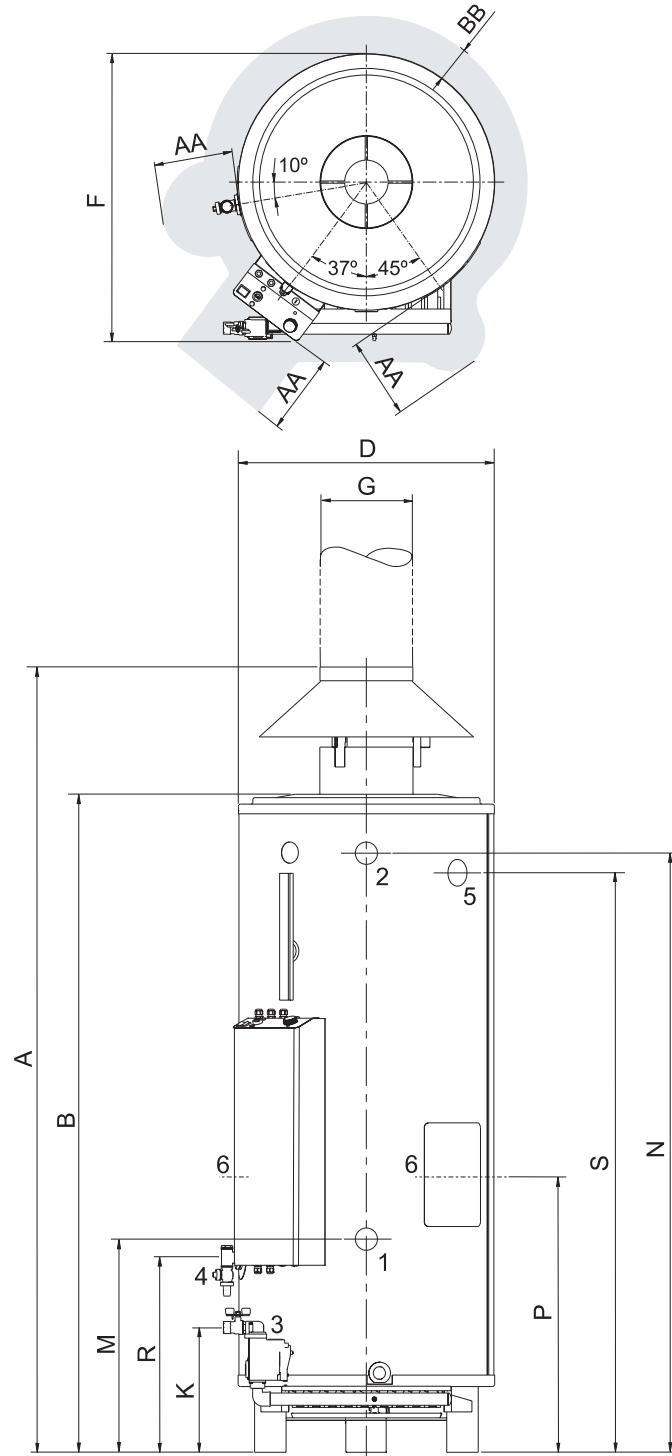
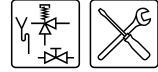

**Figure 3.1** Plan and elevation of the appliance

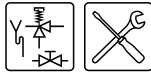

### 3.2 Packaging

To avoid damaging the appliance, remove the packaging carefully.  
We recommend unpacking the appliance at or near its intended location.

---

#### **Caution**

The appliance may only be manoeuvred in an upright position. Take care that the appliance is not damaged after unpacking.

---

### 3.3 Environmental conditions

---

#### **Caution**

The appliance may not be used in rooms where chemical substances are stored or used due to the risk of explosion, and corrosion to the appliance. Some propellants, bleaching agents, degreasing agents etc. disperse vapours which are explosive and/or which cause accelerated corrosion. If the appliance is used in a room in which such substances are present, the warranty will be void.

---

SCT-appliances are open appliances, and may only be placed in an open boiler room. They fall under category B11BS.

#### 3.3.1 Working clearances

For access to the appliance it is recommended that the following clearances are observed (see [Figure 3.1](#)):

- AA: around the appliance's control column and cleaning openings: 100 cm.
- BB: around the appliance itself: 50 cm.
- Above the appliance (room to replace the anodes):
  - 100 cm if using fixed anodes, or
  - 50 cm if using flexible anodes.

If the available clearance is less than 100 cm, flexible magnesium anodes may be ordered from State Water Heaters.

---

#### **Note**

When installing the appliance, be aware that any leakage from the tank and/or connections can cause damage to the immediate environment or floors below the level of the boiler room. If this is the case the appliance should be installed above a wastewater drain or in a suitable metal leak tray.

The leak tray must have an appropriate wastewater drain and must be at least 5 cm deep with a length and width at least 5 cm greater than the diameter of the appliance.

---

#### 3.3.2 Humidity and ambient temperature

The boiler room must be frost-free, or be protected against frost. [Table 3.1](#) shows the environmental specifications which must be observed to guarantee correct functioning of the appliance.

**Table 3.1** Humidity and ambient temperature specifications

Humidity and ambient temperature	
Humidity	max. 93% RH at +25°C
Ambient temperature	Functional: $0 \leq t \leq 60^\circ\text{C}$

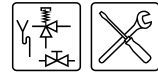

### 3.3.3 Maximum floor loading

Because of the weight of the appliance when filled (see [Table 3.2](#)), verify that the maximum floor loading for the boiler room is not exceeded.

**Table 3.2** Weight specifications with regard to maximum floor loading

Weight of the appliance filled with water						
SCT 80-115	SCT 80-140	SCT 80-180	SCT 95-199	SCT 95-260	SCT 70-360	SCT 65-400
523 kg	523 kg	525 kg	594 kg	597 kg	540 kg	531 kg

### 3.3.4 Water composition

The appliance is intended for heating drinking water. The drinking water must comply with the regulations governing drinking water for human consumption. [Table 3.3](#) shows these requirements.

**Table 3.3** Water specifications

Water composition	
Hardness (alkaline-earth ions)	> 1.00 mmol/l: <ul style="list-style-type: none"> <li>• German hardness &gt; 5.6° dH</li> <li>• French hardness &gt; 10.0° fH</li> <li>• British hardness &gt; 7.0° eH</li> </ul>
Conductivity	> 125 µS/cm
Acidity (pH value)	7,0 < pH value < 9.5

#### Note

If the water specifications deviate from those stated in [Table 3.3](#), then the tank protection cannot be guaranteed.  
See also chapter '10 Warranty (Certificate)'.

## 3.4 Technical specifications

The appliance is supplied without accessories. Check the dimensions and other specifications for any accessories to be used against [Figure 3.1](#) and tables [Table 3.4](#) through [Table 3.7](#).

**Table 3.4** Dimensions SCT

Dimension & Description	SCT 80-115	SCT 80-140	SCT 80-180	SCT 95-199	SCT 95-260	SCT 70-360	SCT 65-400
A. Height including draught diverter (mm)	1910	1910	1890	2155	2155	1950	2145
B. Height excluding draught diverter (mm)	1690	1690	1690	1900	1900	1735	1810
D. Diameter of the appliance (mm)	710	710	710	710	710	710	710
F. Width including control column (mm)	800	800	800	800	800	800	800
G. Flue gas outlet diameter (mm)	130	130	150	180	180	200	250
K. Height of the gas connection (mm)	145	145	145	145	145	145	145
M. Height of the cold water supply (mm)	505	505	505	505	505	515	590
N. Height of the hot water outlet (mm)	1545	1545	1545	1750	1750	1580	1655



**Table 3.4** Dimensions SCT(Continued)

Dimension & Description	SCT 80-115	SCT 80-140	SCT 80-180	SCT 95-199	SCT 95-260	SCT 70-360	SCT 65-400
P. Height of the cleaning opening centre (mm)	710	710	710	710	710	720	795
R. Height of the drain valve centre (mm)	440	440	440	440	440	480	535
S. Height of the T&P plug centre (mm)	1490	1490	1490	1695	1695	1600	1600
1. Cold water supply connection (external)	R 1½						
2. Hot water outlet connection (internal)	Rp 1½						
3. Gas control connection (internal)	Rp ¾						
4. Tank drain valve connection (internal)	Rp 1½						
5. T&P valve connection (internal)	1 -14 NPT						
6. Dimensions of the cleaning opening and inspection opening (mm)	Ø 100						

**Table 3.5** Specifications for gas categories, appliance category: II<sub>2H3+</sub>

Description	Unit	SCT 80-115	SCT 80-140	SCT 80-180	SCT 95-199	SCT 95-260	SCT 70-360	SCT 65-400
<b>Data for natural gas, gas category 2H</b>								
Diameter of orifices	mm	2.90	3.20	3.20	3.30	2.95	3.20	3.30
Burner pressure regulator	-	Yes	Yes	Yes	Yes	Yes	Yes	Yes
<b>G20</b>								
Nominal load (Upper Value)	kW	33.9	42.1	53.4	59.9	83.2	102.6	128.8
Supply pressure	mbar	20	20	20	20	20	20	20
Burner pressure <sup>(1)</sup>	mbar	8.5	8.6	7.8	8.5	8.5	9.2	7.8
Gas consumption <sup>(2)</sup>	m³/h	3.2	4.0	5.1	5.7	7.9	9.8	12.3
Heating-up time dT = 44 K	min.	38	30	23	25	17	11	8
<b>Data for LP gas, gas category 3+</b>								
Diameter of orifices	mm	1.60	1.70	1.60	1.75	1.50	1.70	1.75
<b>G30 - 30 mbar (butane)</b>								
Nominal load (Upper Value)	kW	33.9	42.2	53.4	59.2	80.8	100.1	127.5
Supply pressure	mbar	30	30	30	30	30	30	30
Burner pressure <sup>(1)</sup>	mbar	-	-	-	-	-	-	-
Gas consumption <sup>(2)</sup>	kg/h	2.5	3.1	3.9	4.3	5.9	7.3	9.3

1. If using a flat sealing plate instead of burner pressure regulator, it is assumed that the burner pressure is equal to the supply pressure. In practice however the burner pressure will be lower

2. Based on 1013.25 mbar and 15°C

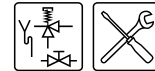
**Table 3.5** Specifications for gas categories, appliance category: II<sub>2H3+</sub> (Continued)

Description	Unit	SCT 80-115	SCT 80-140	SCT 80-180	SCT 95-199	SCT 95-260	SCT 70-360	SCT 65-400
<b>G31 (propane)</b>								
Nominal load (Upper Value).	kW	33.1	41.4	52.8	58.2	78.4	98.3	125.5
Supply pressure	mbar	37	37	37	37	37	37	37
Burner pressure <sup>(1)</sup>	mbar	-	-	-	-	-	-	-
Gas consumption <sup>(2)</sup>	kg/h	2.4	3.0	3.8	4.2	5.6	7.0	9.0

1. If using a flat sealing plate instead of burner pressure regulator, it is assumed that the burner pressure is equal to the supply pressure. In practice however the burner pressure will be lower

2. Based on 1013.25 mbar and 15°C

**Table 3.6** General data

Description	Unit	SCT 80-115	SCT 80-140	SCT 80-180	SCT 95-199	SCT 95-260	SCT 70-360	SCT 65-400
Capacity	litres	309	309	298	357	335	278	253
Number of bar burners/orifices	-	3	3	4	4	7	7	9
Number of flue tubes/flue baffles	-	5	5	7	6	9	12	16
Empty weight	kg	214	214	227	237	262	262	278
Number of anodes	-	2	2	2	2	3	3	4
Maximum working pressure	bar	8	8	8	8	8	8	8

**Table 3.7** Electrical data

DESCRIPTION	Unit	All models
Electrical power consumption	W	30
Supply voltage	ACS (VAC)	230 (-15% +10%)
Net frequency	Hz	50 (±1 Hz)

**3.5 Installation diagrams** Figure 3.2 shows the water and gas connection diagrams for unvented and vented installations. The following paragraphs, describing the connections in detail, make reference to these diagrams.



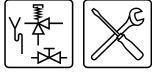

Legend

- ❶ pressure-reducing valve (mandatory)
- ❷ expansion vessel (mandatory)
- ❸ T&P valve (mandatory)
- ❹ stop valve (recommended)
- ❺ non-return valve (mandatory)
- ❻ circulation pump (optional)
- ❼ drain valve
- ❽ gas valve (mandatory)
- ❾ stop valve (mandatory)
- ❿ temperature gauge (recommended)
- ⓫ shunt pump (optional)
- ⓬ draught diverter
- ⓭ hot water draw-off points
- ⓮ pressure relief valve (mandatory)
- ⓯ water cistern
- ⓰ float valve
- ⓱ 3-way venting valve (recommended)
- ⓲ overflow pipe
- ⓳ cold water supply
- ⓴ hot water outlet
- ⓵ circulation pipe
- ⓶ gas supply
- ⓷ flue gas discharge

UNVENTED

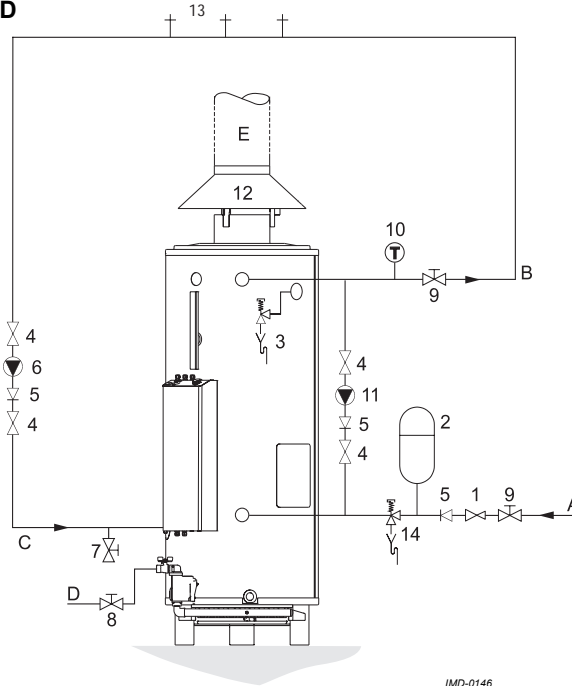

VENTED

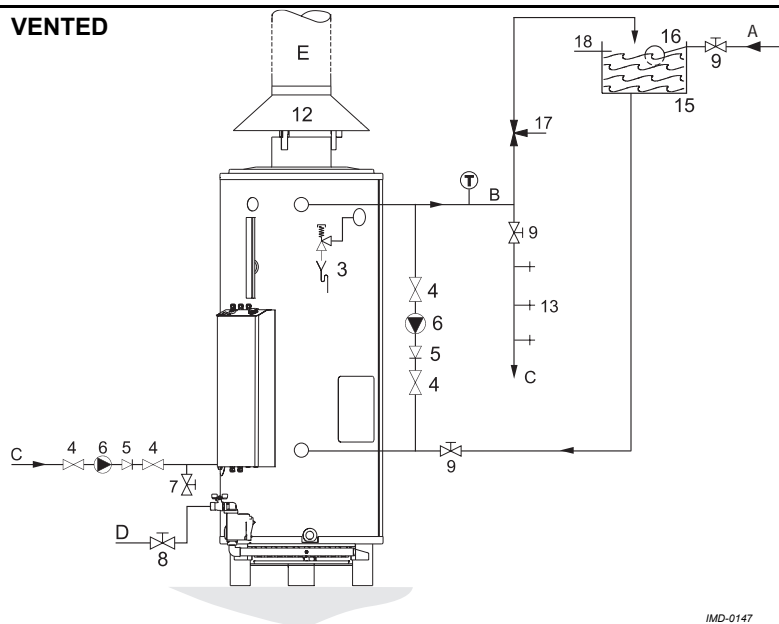
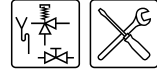

Figure 3.2 Installation diagrams



### 3.6 Water connections Unvented

#### 3.6.1 Cold water side

See ❶ in [Figure 3.2](#).

1. Fit an approved stop valve ❸ on the cold water side as required by regulations.  
See also paragraph '1.3 Regulations'.
2. The maximum working pressure of the appliance is 8 bar. Because the pressure in the water pipe at times can exceed 8 bar, you must fit an approved pressure-reducing valve ❶.
3. Fit a non-return valve ❷ and an expansion vessel ❹.
4. Fit a pressure relief valve ❺ and connect the overflow side to an open water wastewater pipe.

#### 3.6.2 Shunt pipe

You can connect a shunt pump to prevent stacking of the water in the water heater.

1. Optional: fit a shunt pipe depending on the tap design (Ø 22 mm), a stop valve ❸ and a shunt pump ❶.
2. Fit a non-return valve ❷.
3. Fit a stop valve ❸.

#### 3.6.3 Hot water side

See ❸ in [Figure 3.2](#).



#### Note

Insulating long hot water pipes prevents unnecessary energy loss.

1. Fit the T&P valve ❹.
1. Optional: fit a temperature gauge ❿ to be able to check the temperature of the tap water.
2. Fit a stop valve ❸ in the hot water outlet pipe, for use when servicing.

#### 3.6.4 Drain valve

1. Fit the standard drain valve ❼ supplied.
2. Refer to paragraph [3.6.5](#) if a circulation pipe is to be fitted. Otherwise, fit the sealing nut and gasket supplied with the drain valve. See [Figure 3.3](#).



### 3.6.5 Circulation pipe

See ⑥ in Figure 3.2. and Figure 3.3.

If an immediate flow of hot water is required at draw-off points, a circulation pump can be installed. This improves comfort and reduces water wastage.

1. Fit a circulation pump ⑥ of the correct capacity for the length and resistance of the circulation system.
2. Fit a non-return valve ⑤ behind the circulation pump to guarantee the direction of circulation.
3. Fit two stop valves for servicing ④.
4. Connect the circulation pipe to the T-piece on the drain valve ⑦. See Figure 3.3.

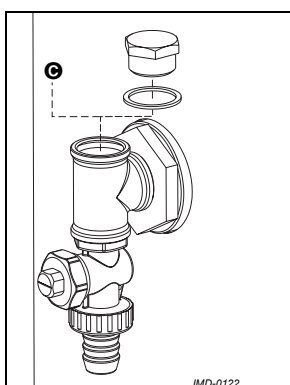

Figure 3.3 Drain valve

## 3.7 Water connections Vented

### 3.7.1 Cold water side

See ④ in Figure 3.2.

- Fit an approved stop valve on the cold water side between the water cistern ⑩ and the appliance ⑨ as required by regulations. See also paragraph '1.3 Regulations'.

### 3.7.2 Shunt pipe

You can connect a shunt pump to prevent stacking of the water in the water heater.

1. Optional: fit a shunt pipe depending on the tap design (Ø 22 mm), a stop valve ⑨ and a shunt pump ①.
2. Fit a non-return valve ⑤.
3. Fit a stop valve ⑨.

### 3.7.3 Hot water side

See ⑥ in Figure 3.2.

#### Note

Insulating long hot water pipes prevents unnecessary energy loss.

1. Fit the T&P valve ⑧.
2. Optional: fit a temperature gauge ⑩ to be able to check the temperature of the tap water.
3. Fit a stop valve ⑨ in the hot water outlet pipe, for use when servicing.
4. Refer to paragraph 3.7.4 if a circulation pipe is to be fitted.

### 3.7.4 Circulation pipe

See ⑥ in Figure 3.2.

If an immediate flow of hot water is required at draw-off points, a circulation pump can be installed. This improves comfort and reduces water wastage.

1. Fit a circulation pump ⑥ of the correct capacity for the length and resistance of the circulation system.
2. Fit a non-return valve ⑤ behind the circulation pump to guarantee the direction of circulation.



3. Fit two [stop valves](#) for servicing ④.
4. Connect the circulation pipe to the cold water supply pipe.

### 3.8 Gas connection



#### Warning

Gas installation may only be carried out by an authorised installation engineer in compliance with the general regulations imposed by the gas company.  
See also paragraph '[1.3 Regulations](#)'.



#### Caution

Make sure that the diameter and length of the gas supply pipe is are large enough to supply sufficient capacity to the appliance.

See ⑤ in [Figure 3.2](#).

1. Fit a gas valve ⑥ in the gas supply pipe.
2. Blow the gas pipe through before use, to be sure it is clean.
3. Close the gas valve.
4. Fit the gas supply pipe to the gas control.



#### Warning

Check for leaks after fitting.

### 3.9 Flue gas discharge



#### Warning

The installation should be carried out by an authorised installation engineer, in compliance with the general and local regulations imposed by gas, water supply and power supply companies and the fire service.  
See also paragraph '[1.3 Regulations](#)'.

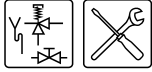

### 3.9.1 Introduction

When connecting the appliance to the chimney, the draught diverter ❶ supplied with the appliance must be used. The standard flue gas thermostat and sensor that are supplied must be fitted in the draught diverter.

### 3.9.2 Fitting the draught diverter

The draught diverter ❶ is fastened using two fastening screws ❷. The assembly procedure is as follows:

#### Legend

- ❶ draught diverter
- ❷ fastening screws
- ❸ chimney pipe

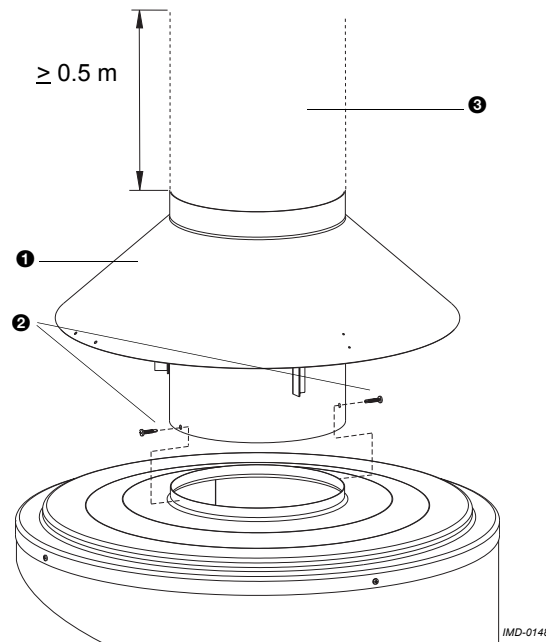

Figure 3.4 Fitting the draught diverter

1. Place the draught diverter on the appliance and mark the drill holes. Remove the draught diverter from the appliance.

#### Note

The position of the holes already made for the flue gas backflow safeguard sensor must be taken into account. The holes should be roughly in line with the flue gas thermostat bracket.

2. Now drill two holes into the top of the appliance (3.2 mm drill bit).
3. Using the fastening screws, fix the draft diverter to the appliance.
4. Fit a vertical chimney pipe ❸ of at least 0.5 metres length to the opening of the draft diverter, before fitting the rest of the chimney materials according to current regulations. See paragraph '1.3 Regulations'.

#### Note

Use flue gas discharge materials that comply with the regulations. See paragraph '1.3 Regulations'.

#### Note

Make sure that the chimney discharges into an area where this is permitted for this category of appliance.

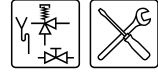

### 3.9.3 Flue gas thermostat assembly

The flue gas thermostat sensor is already mounted in the draught diverter. The bracket with thermostat needs to be mounted on the top of the unit and the cable from the thermostat needs to be connected with the connector on the unit.

#### Warning

*If the flue gas thermostat is not (or is incorrectly) fitted/connected, the flue gas discharge will not be protected. An incorrectly fitted chimney can cause flue gases to backflow into the boiler room.*

#### Note

[Figure 3.5](#) shows an example. For each type of unit the position of the sensor can slightly differ.

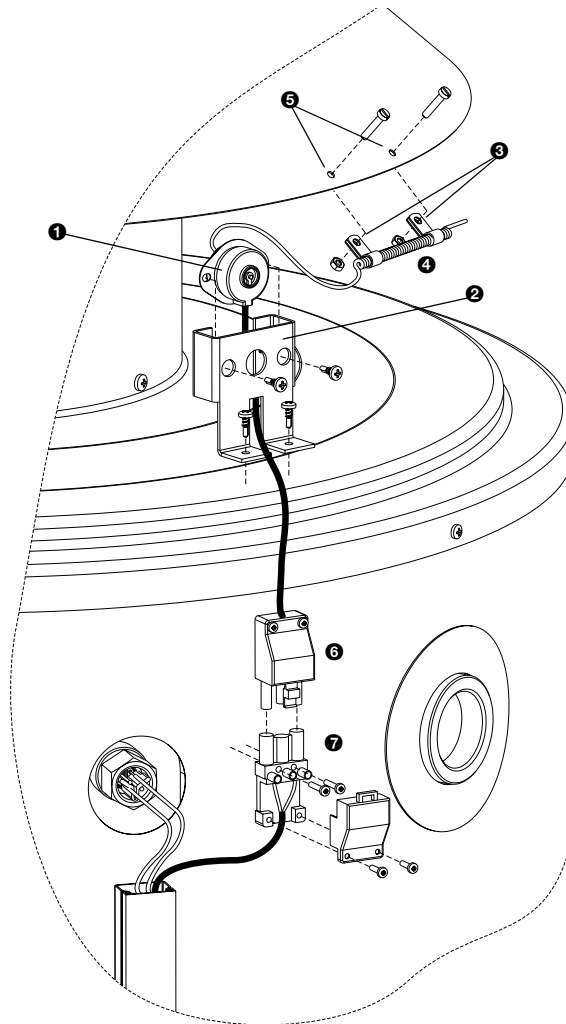

IMD-0187

**Figure 3.5** Flue gas backflow safeguard

Fit the flue gas thermostat as follows:

1. Remove the flue gas thermostat assembly ❶ from the packet.
2. Fit the bracket ❷ with the thermostat to the top of the appliance.

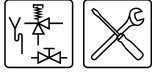

- Plug the connector from the flue gas thermostat ⑥ to the connector on the appliance ⑦.

### 3.10 Electrical connection

#### Warning

The installation should be carried out by an approved installation engineer in compliance with the general and local regulations imposed by the gas, water and power supply companies and the fire service.  
See also paragraph '1.3 Regulations'.

#### 3.10.1 Introduction

This paragraph covers each of the following:

- 3.10.2 Mains power;
- 3.10.3 Week timer circuit

Figure 3.6 shows a front view of the electrical connecting block. Table 3.8 shows the associated connections.

Table 3.8 Electrical connecting block SCT

Mains voltage			Flue gas backflow safeguard					Week timer circuit					
⊕	L <sub>1</sub>	N	⊕	L <sub>2</sub>	L <sub>3</sub>	N	⊕	N	N	L	L	L	L
1	2	3	4	5	6	7	8	9	10	11	12	13	14

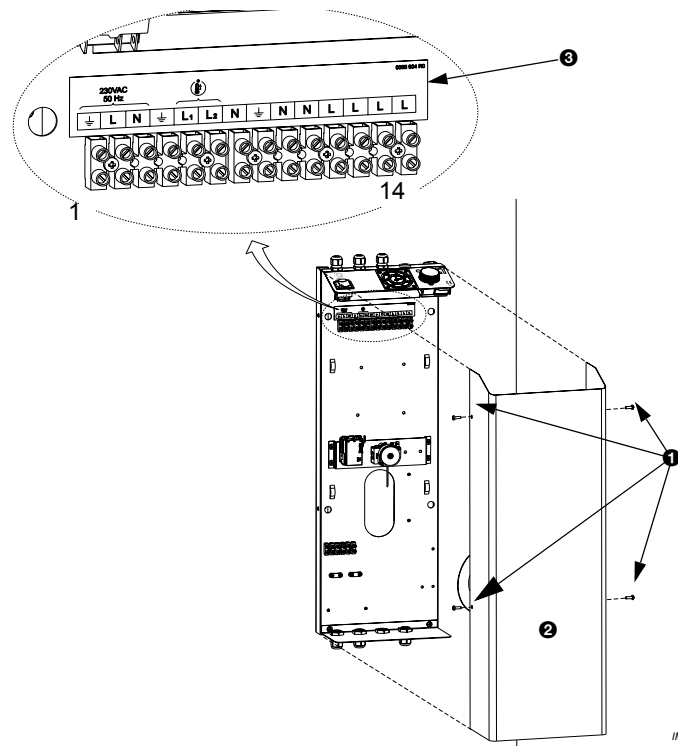
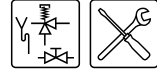

Figure 3.6 Connecting block (connections 1 to 14 explained in Table 3.8)



In preparation, first remove the protective cover from the control column:

- Undo the 4 screws ❶ and remove the protective cover ❷ from the electrical section. The connecting block ❸ is now visible.



#### Note

Consult '[A SCT electrical diagram](#)' for electrical component connections.

### 3.10.2 Mains power

The appliance is supplied without a power cord and main switch.



#### Note

In order to receive electrical power, the appliance has to be connected to the mains voltage by means of a permanent electrical connection. A two-terminal main switch with a contact gap of at least 3 mm must be fitted between this fixed connection and the appliance. The power cord must have cores of at least 3 x 1.0 mm<sup>2</sup>.

1. Feed the power cord through the metric pull relief on the top of the control column.
2. Connect earth ( $\perp$ ), phase (L<sub>1</sub>) and neutral (N) on the power cord to points 1 to 3 of the connecting block as set out in [Table 3.8](#).
3. Tighten the pull relief so that the cable is clamped.
4. If you do not need to make any more connections, then fit the protective cap on the control column.
5. Connect the power cord to the main switch.



#### Warning

Leave the appliance disconnected until you are ready to start it up.

### 3.10.3 Week timer circuit

1. Cut out the week timer image from the control panel.
2. Fit the week timer in the hole.
3. Connect the week timer by connecting the wires with core bush to 10(N), 12(L) and 14 (L).
4. Connect the cable with sliding bush to position B4 of the I/O/II-switch.
5. If you do not need to make any more connections, then fit the protective cap on the control column.

### 3.11 Conversion to a different gas category



#### Caution

The conversion may only be carried out by an authorised installation engineer.



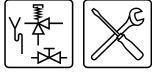

### 3.11.1 Introduction

If the appliance must operate on a family of gas (LP-gas or natural gas) other than the category of gas for which the appliance has been set up at the factory, the appliance will have to be adapted using a special conversion kit. Converting the SCT appliances is described in '3.11.2 Conversion to a different gas category'.

#### Legend

- ❶ cover plate
- ❷ locking strip
- ❸ orifice with stamped figures

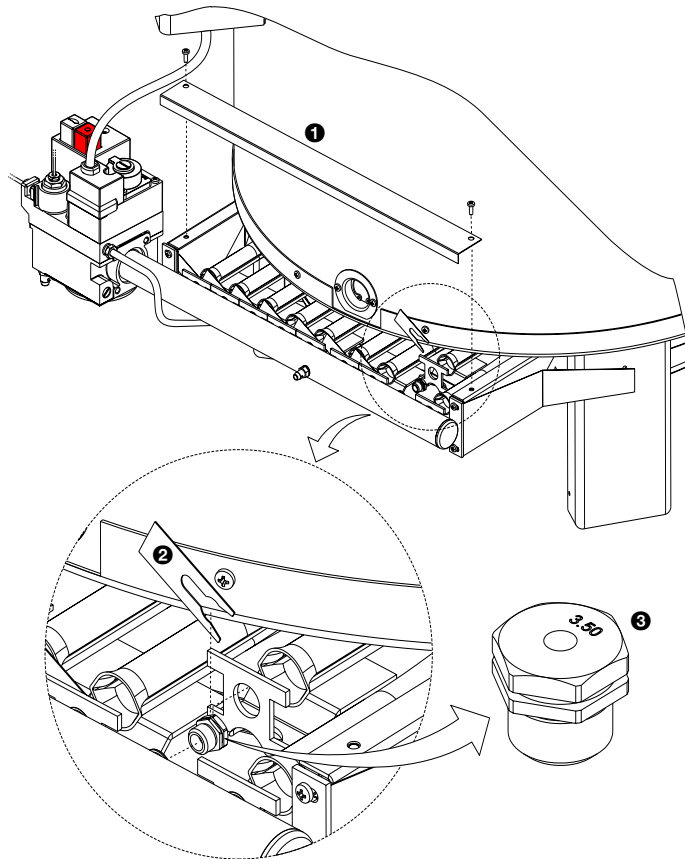

IMD-0196

Figure 3.7 Replacing the orifices

### 3.11.2 Conversion to a different gas category

1. Disconnect the appliance from the mains. See paragraph '7.3.2 Disconnecting the appliance from the mains'.
2. Shut off the gas supply.
3. Unscrew the cover plate ❶ from the burner support.
4. Use a suitable tool to remove the locking strips ❷. Note: the locking strips have especially sharp edges. Withdraw the locking strips straight upwards.



#### Take care

The burner may be hot.

#### Note

The radiation shield / condensation tray can be temporarily loosened to simplify assembly of the burner.

5. Remove the burners one by one from their brackets at the front. To do this, you first move them away from you and then downwards. The orifices are then accessible.
6. Remove the orifices.

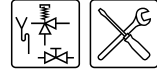

7. Select and fit the correct orifices from the conversion kit, by referring to [Table 3.9](#). The orifice diameter is shown on the orifice by means of stamped figures ③.

#### Legend

See [Figure 3.7](#) for ① to ③.

- ④ burner pressure regulator
- ⑤ flat sealing plate
- ⑥ supply pressure test nipple
- ⑦ burner pressure test nipple
- ⑧ gas control
- ⑨ burner pressure control cap
- ⑩ burner pressure control adjusting screw

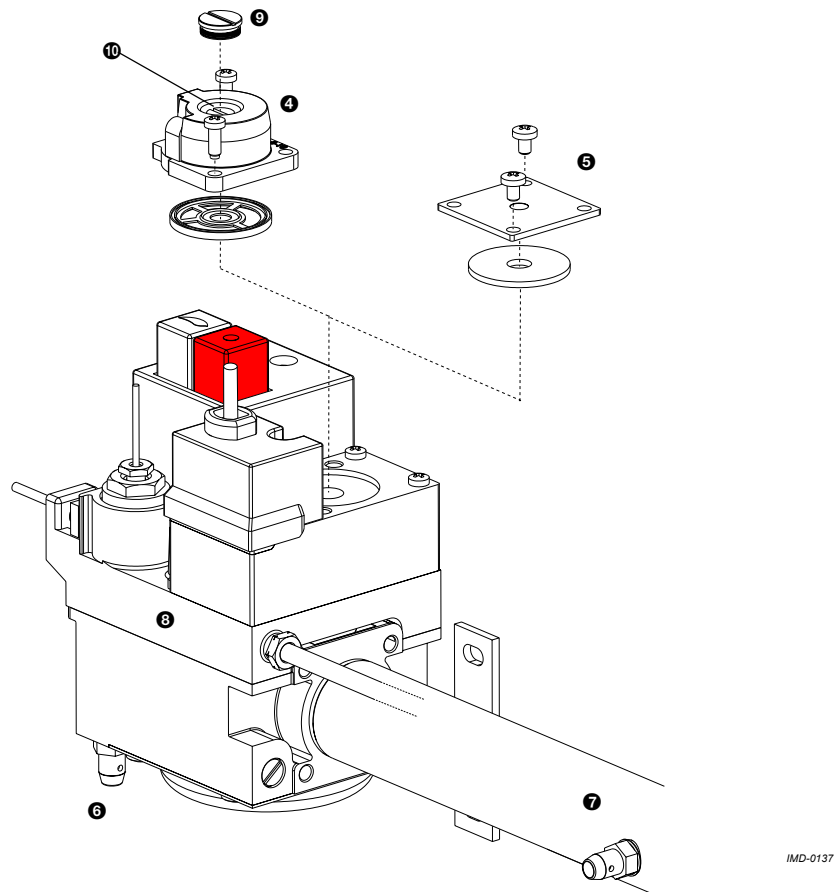

IMD-0137

**Figure 3.8** Converting the gas control

8. Refit the burners back in their original position.
9. Re-fit the locking strips.



#### Note

If the radiation shield /condensation tray was loosened, re-tighten it.

10. Check whether there is a burner pressure regulator ④ attached to the top of the gas control, or simply a flat sealing plate ⑤.
11. Check with the help of the burner pressure in [Table 3.5](#) whether a burner pressure regulator is required for the new gas category.
12. If the flat sealing plate must be replaced with a burner pressure regulator, or vice versa:
  - Remove the existing flat sealing plate ⑤ or burner pressure regulator ④.
  - Fit the new burner pressure regulator or flat sealing plate supplied with the conversion kit.
13. Check the burner pressure and supply pressure (see paragraph [3.12](#)).

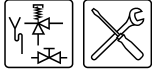

### 3.12 Checking the supply pressure and burner pressure

14. Remove the sticker showing the new gas category from the conversion kit, attach it below the appliance's rating plate. This clearly indicates that the appliance may no longer be run on the gas for which it was originally supplied.
15. Start up the appliance (see paragraph 7.2).

---

#### Note

Before you start up the appliance and/or begin to check the supply pressure and burner pressure, you must fill the appliance. For the filling procedure, please refer to paragraph '4.2 Filling the appliance'.

---

---

#### Caution

Before starting-up for the first time, and following conversion, you must always check the supply pressure and burner pressure. If necessary, adjust these to be certain of optimum performance of the appliance.

---

---

#### Note

The easiest way to check the gas pressures is by using two pressure gauges. This procedure assumes that these two gauges are available.

---

1. Switch off the power to the appliance and extinguish the pilot flame. See paragraph '7.3.2 Disconnecting the appliance from the mains'.
2. The supply pressure is checked using a test nipple ⑥ on the gas control (Figure 3.8). The manifold test nipple ⑦ is used for measuring the burner pressure. Sealing screws are located inside the test nipples. Loosen both sealing screws by a few turns. Do not completely undo them, as it may be awkward retightening them.
3. There are two test nipples on the gas control ⑦.
4. Open the gas supply and vent the gas supply line via supply pressure test nipple ⑥.
5. Connect a pressure gauge to the supply pressure test nipple ⑥ as soon as gas starts to flow from this nipple.
6. Switch on the power to the appliance using the main switch on the appliance.
7. Begin the ignition procedure by pressing and holding the white button on the gas control while repeatedly pressing the piezo igniter until the pilot flame ignites. The pilot flame can be seen through the inspection window above the burner tray.
8. Keep the white button pressed in for about 30 seconds before carefully releasing it. The pilot flame must now keep burning.
9. Set the control thermostat to the highest position (take note of the original setting) and set the I/O/II-switch back to position I.
10. If there is no heat demand, then draw-off some hot water to initiate a heat demand.
11. The heating cycle will start and the burner tray will ignite after a short time.

---

#### Warning

If the pilot flame goes out during the ignition procedure or heating cycle, you must wait 5 minutes before repeating the ignition procedure.

---

12. After the burner tray has ignited, wait for approximately 1 minute before you start reading the dynamic pressures.

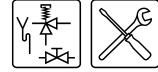

13. Use the pressure gauge to read the supply pressure at the test nipple ⑥.  
Refer to [Table 3.9](#).

**Note**

Consult the mains gas supply company if the supply pressure is not correct.

14. Use the pressure gauge to read the burner pressure at the burner pressure test nipple. Refer to [Table 3.9](#).

**Table 3.9** Conversion data for appliance category II2H3+

DESCRIPTION	Unit	SCT 80-115	SCT 80-140	SCT 80-180	SCT 95-199	SCT 95-260	SCT 70-360	SCT 65-400
<b>Data for natural gas, gas category 2H</b>								
Diameter of orifices	mm	2.90	3.20	3.20	3.30	2.95	3.20	3.30
<b>G20</b>								
Supply pressure	mbar	20	20	20	20	20	20	20
Burner pressure	mbar	8.5	8.6	7.8	8.5	8.5	9.2	7.8
<b>Data for LP gas, gas category 3+</b>								
Diameter of orifices	mm	1.60	1.70	1.60	1.75	1.50	1.70	1.75
<b>G30 (butane)</b>								
Supply pressure	mbar	30	30	30	30	30	30	30
Burner pressure <sup>(1)</sup>	mbar	-	-	-	-	-	-	-
<b>G31 (propane)</b>								
Supply pressure	mbar	37	37	37	37	37	37	37
Burner pressure <sup>(1)</sup>	mbar	-	-	-	-	-	-	-

1. If a flat sealing plate or high-low regulator is in use, the burner pressure is expected to be the same as the supply pressure. In practice however, the burner pressure will be lower.

**Note**

If the burner pressure is not correct and the appliance is fitted with a flat sealing plate (⑤), you will not be able to adjust the pressure. In this case, consult your installation engineer or supplier. If the appliance is fitted with a burner pressure regulator, then the pressure can be adjusted by following steps 15 to 20.

15. Remove the cap ⑨ from the burner pressure regulator ④.
16. Adjust the burner pressure by turning the adjusting screw ⑩, depending on the correction required:
- To reduce burner pressure, turn the adjusting screw anti-clockwise;
  - To increase burner pressure, turn the adjusting screw clockwise;
17. Cover the opening of the adjusting screw and check the burner pressure against the target value from [Table 3.9](#).
18. If the pressure reading is not correct, repeat steps 16 and 17 until the correct pressure is attained.
19. Re-fit the cap ⑨ on the burner pressure regulator.

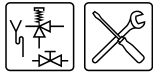

### ***Checking the supply pressure and burner pressure***

20. Shut down the appliance by setting the I/0/II-switch to the **0 position**.
21. Shut off the gas supply.
22. Disconnect the two pressure gauges and re-tighten the sealing screws in the test nipples.

# 3

## Installation

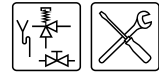

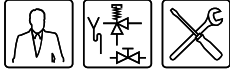

# 4 Filling and draining

## 4.1 Introduction

Topics covered in this chapter:

- [Filling the appliance.](#)
- [Draining the appliance.](#)

The components referred to in these sections are illustrated in [Figure 4.1](#).

### Legend

- ❶ pressure-reducing valve (mandatory)
- ❷ expansion vessel (mandatory)
- ❸ T&P valve (mandatory)
- ❹ stop valve (recommended)
- ❺ check valve (mandatory)
- ❻ circulation pump (optional)
- ❼ drain valve
- ❽ gas valve (mandatory)
- ❾ stop valve (mandatory)
- ❿ temperature gauge (recommended)
- ⓫ shunt pump (optional)
- ⓬ draught diverter
- ⓭ hot water draw-off points
- ⓮ pressure relief valve (mandatory)
- ⓯ water cistern
- ⓰ float valve
- ⓱ 3-way venting valve (recommended)
- ⓲ overflow pipe
- ⓳ cold water supply
- ⓴ hot water outlet
- ⓵ circulation pipe
- ⓶ gas supply
- ⓷ flue gas discharge

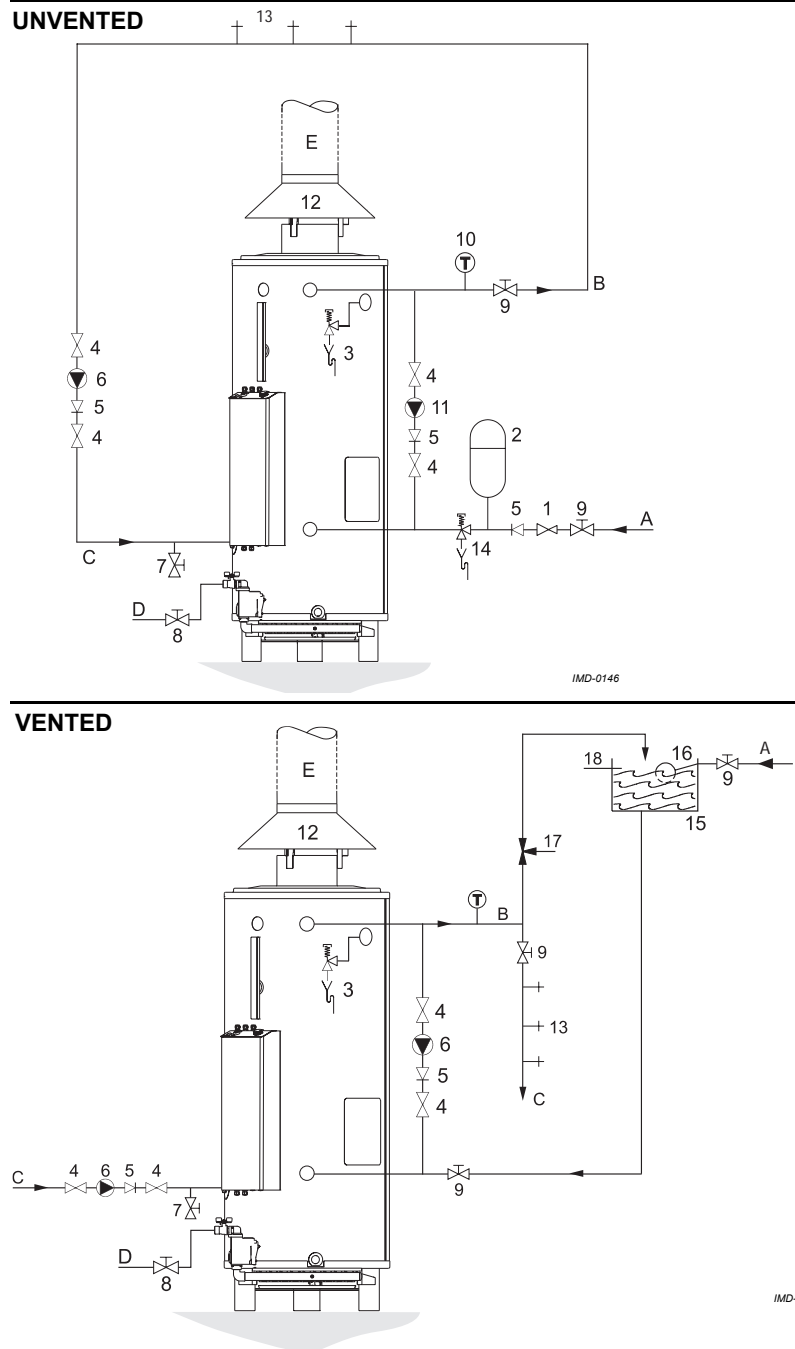
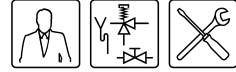

Figure 4.1 Connection diagrams



## 4.2 Filling the appliance

### 4.2.1 Filling unvented installations

To fill the appliance, proceed as follows.

1. Open the stop valve ⑨ on the hot water pipe and, if present, the stop valves ④ for the circulation pump.
2. Close the drain valve ⑦.
3. Open the nearest hot water draw-off point ⑩.
4. Open the stop valve ⑨ on the cold water side ① so that cold water flows into the appliance.
5. Completely fill the appliance (when cold water flows at normal pressure from the nearest hot water draw-off point, the appliance is full).
6. Bleed the entire installation of air, by opening all hot water draw-off points, for example.
7. The appliance is now under water supply pressure. There should be no water coming out of the overflow valve ⑪ nor the T&P-valve ③. If this does happen, the cause might be:
  - The water supply pressure is greater than the stipulated 8 bar.  
Rectify this by fitting a pressure-reducing valve ①.
  - The overflow valve in the cold water supply arrangement is defective or incorrectly fitted.

### 4.2.2 Filling vented installations

To fill the appliance, proceed as follows:

1. Open the stop valve ⑨ on the hot water pipe and, if present, the stop valves ④ for the circulation pump.
2. Close the drain valve ⑦.
3. Open the nearest hot water draw-off point ⑩.
4. Open the stop valve ⑨ on the cold water side ① so that cold water flows into the appliance.
5. Completely fill the appliance (when cold water flows at normal pressure from the nearest hot water draw-off point, the appliance is full).
6. Bleed the entire installation of air, by opening all hot water draw-off points, for example.
7. The appliance is now under water supply pressure. There should be no water coming out of the T&P-valve ③. If this does happen, the T&P-valve might be defective or incorrectly fitted.

## 4.3 Draining the appliance

### 4.3.1 Draining unvented installations

For some procedures may require the appliance to be drained. Proceed as follows:

1. Shut the appliance down by setting the I/O/II-switch to the 0 position.
2. Switch off the power to the appliance by setting the main switch between the appliance and the mains power supply to its 0 position.
3. Close the gas supply ⑤.
4. Close the stop valve ⑨ in the hot water outlet ⑥.
5. Close the stop valve ⑨ in the cold water supply pipe ①.
6. Open the drain valve ⑦.



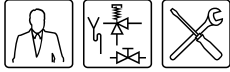

7. Bleed the appliance (or installation) so that it drains completely empty.

#### **4.3.2 Draining vented installations**

For some procedures may require the appliance to be drained. Proceed as follows:

1. Shut the appliance down by setting the I/O/II-switch to the **0 position**.
2. Switch off the power to the appliance by setting the main switch between the appliance and the mains power supply to its 0 position.
3. Close the gas supply **6**.
4. Close the stop valve **9** in the hot water outlet **8**.
5. Close the stop valve **9** in the cold water supply pipe **4**.
6. Open the drain valve **7**.
7. Bleed the appliance (or installation) so that it drains completely empty.

# 4

## Filling and draining

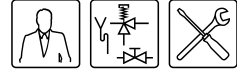

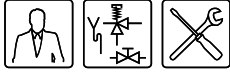

# 5 Controls

## 5.1 Introduction

Topics covered in this chapter:

- 5.2 Control panel;
- 5.3 Explanation of the icons;
- 5.4 I/O/II-switch;
- 5.5 Control thermostat;
- 5.6 Week timer circuit
- 5.7 Flue gas backflow safeguard reset button.

## 5.2 Control panel

Figure 5.1 illustrates the control panel. The panel consists of:

- an I/O/II-switch;
- a control thermostat with rotary knob;
- a week timer (optional);
- a Power Anode indicator LED (optional).

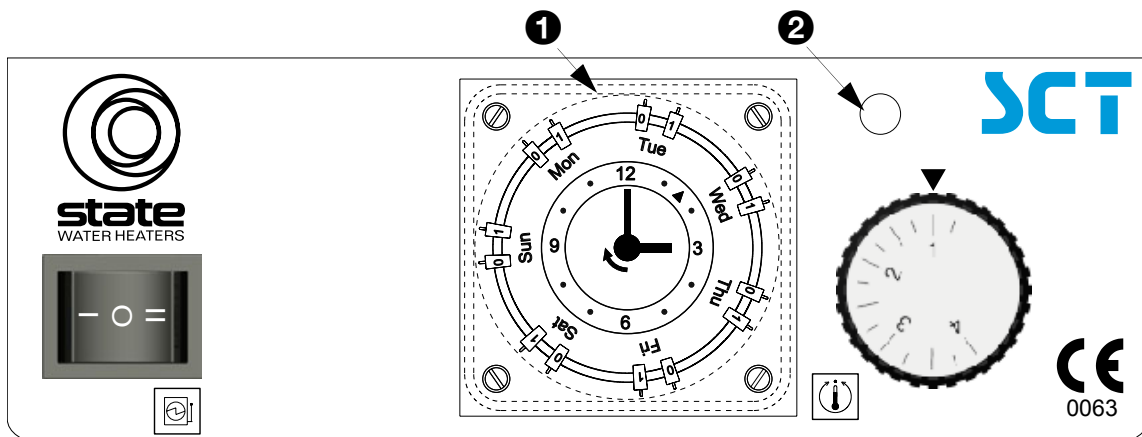
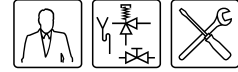





Figure 5.1 The control panel



### 5.3 Explanation of the icons

Table 5.1 explains the icons on the control panel.

**Table 5.1** Control panel icons

Icon	Name	Explanation
	I/O/II switch	Sets appliance mode to 'ON', 'Week Program' or 'OFF'.
	Temperature control	Sets water temperature ( $T_{set}$ )
	Week timer	Sets the weekly water heating program
	Power Anode indicator lamp	Shows Power Anode status

### 5.4 I/O/II-switch

Using the I/O/II-switch, set the appliance to the ON mode ('I' position), OFF mode ('O' position), or the weekly program mode ('II' position). See paragraph '6.2 Operating states'.

The appliance remains live, even when in the OFF mode. This keeps the weekly water heating program and/or Power Anode active.



#### Note

To electrically disconnect the appliance, you must use the main switch between the appliance and the mains power supply.

### 5.5 Control thermostat

Use the rotary knob on the control thermostat to set the desired water temperature to between  $\pm 40^{\circ}\text{C}$  and  $\pm 70^{\circ}\text{C}$ . The rotary knob is continuous over a scale of 1 to 4. Table 5.2 shows the approximate temperature at each position.

**Table 5.2** Temperature settings

Position	Temperature
1	$\pm 40^{\circ}\text{C}$
2	$\pm 50^{\circ}\text{C}$
3	$\pm 60^{\circ}\text{C}$
4	$\pm 70^{\circ}\text{C}$

### 5.6 Week timer circuit

Optionally, you can use the week timer to program when the appliance must supply the heat demand. Set the I/O/II-switch to the 'II' position to activate the week timer circuit.

The timer ❶ week disk ❷ is divided into seven segments, "Monday" to "Sunday". Each day is divided into 12 tabs ❸ (2 hours per tab).

To set a two-hour period during which the appliance must respond to a heat demand, press the tab for that period outwards.

The current time can be read from the hands ❹ (12 hour clock).

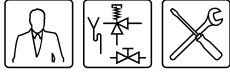

Set the day and time as follows: to set roughly, turn the week disk ② in the direction of the arrow until the current weekday is aligned with the marker arrow ③; for fine setting, turn the minute hand clockwise until the current time is set. For the timer program to work, the manual switch ⑤ must always be in the central position.

Legend:

- ① timer
- ② week disk
- ③ marker arrow
- ④ hands
- ⑤ manual switch
- ⑥ tabs



Figure 5.2 Week timer

**5.7 Flue gas backflow safeguard reset button**

A malfunction in the flue gas discharge, e.g. a blockage in the chimney, can lead to the flue gas thermostat locking out. This state can be recognised by the fact that the push button for the flue gas thermostat has been activated, see [Figure 5.3](#). Once the cause is removed, and if the sensor has cooled down sufficiently, press this button to release the interlock (if you do not allow the sensor to cool down sufficiently, the flue gas thermostat will again immediately lock out). The appliance will then automatically start up again, if there is a current heat demand. If the appliance does not re-start when it should, refer to chapter '8 Troubleshooting' for an extensive overview of error conditions.

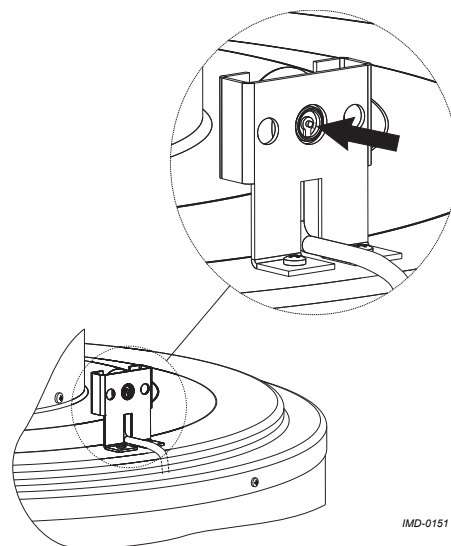
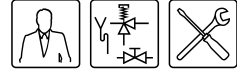
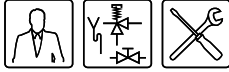

Figure 5.3 Flue gas backflow safeguard reset button





# 6 Status of the appliance

## 6.1 Introduction

Topics covered in this chapter:

- [6.2 Operating states](#);
- [6.3 Power Anode Status](#);
- [6.4 Error states](#).

## 6.2 Operating states

During operation the appliance has four basic operating states, namely:

- **DISCONNECTED**

In this state the appliance is off and all components are electrically dead. The main switch (switch between the appliance and the power supply) is set to off. On the control panel the **I/O/II**-switch is set to the **0 position**.

---

 **Note**

If no week timer is installed, the 'II' state is the same as the '0' state.

---

- **OFF**

The main switch is set to position I. On the control panel the **I/O/II** switch is set to the **0 position**.

- **ON**

In this state the appliance continuously fulfils the demand for heat. On the control panel:

- The **I/O/II**-switch is set to the **I position**.
- The water temperature can be set by turning the rotary knob on the control thermostat, see paragraph [5.5 Control thermostat](#).

- **WEEK PROGRAM** (optional)

In this position the appliance only meets the heat demand during the periods set by the timer. Outside these periods, only frost protection is active.

On the control panel:

- The **I/O/II**-switch is set to the **II position**.
- The water temperature can be set by turning the rotary knob on the control thermostat, see paragraph [5.5 Control thermostat](#).
- The period during which the heat demand must be fulfilled can be programmed using the week timer, see paragraph [5.6 Week timer circuit](#).

## 6.3 Power Anode Status

If the appliance is fitted with a Power Anode, there is an extra indicator lamp on the operating panel. Depending on the status of the appliance, this lamp will be lit either Green or Red, or it will be Off:

- **Green**

This state indicates that the Power Anode is working correctly.

- **Red**

This state indicates an error, and the Power Anode is not working.

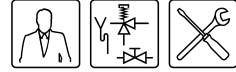

- **Off**  
This state indicates that the Power Anode is not working.

**Note**

If there is an error with the Power Anode (Red), or if the Power Anode is not working (Off), this will have no effect on the hot water supply. However, no tank protection will take place.

**6.4 Error states**

If the appliance has an error, heat demand will be (temporarily) ignored. There are various types of errors, divided into three groups:

- **Gas control lock out errors**

In this case the gas control's safety valve is closed, as a result of which the pilot flame is extinguished. Once this error has been rectified, the pilot flame must be re-lit. See paragraph '[7.2 Starting up](#)'.

- **Blocking errors**

In this case the gas control's main valve is closed. Despite a possible heat demand, combustion is stopped although the pilot flame remains ignited. These errors disappear automatically once the cause of the error disappears, after which the appliance re-starts itself.

- **Lock out error due to the flue gas backflow safeguard**

This error state has much the same characteristics as a 'Blocking error'. The difference here is that the lock out (push button) for the flue gas thermostat in the draught diverter is activated. See paragraph '[5.7 Flue gas backflow safeguard reset button](#)'. After removing the cause, the push button must be pressed to allow the appliance to automatically re-start.

The cause of the error cannot be seen on the control panel. Please refer to chapter '[8 Troubleshooting](#)' for a detailed overview of error states.

If you find the appliance in a fault state, as an end user you can attempt to re-start the appliance, see paragraph '[7.2 Starting up](#)'

However, should the error return or become persistent, you should contact your service engineer.



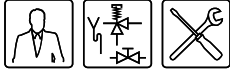

# 7 Starting up and shutting down

## 7.1 Introduction

Topics covered in this chapter:

- [Starting up](#);
- [Shutting down](#).

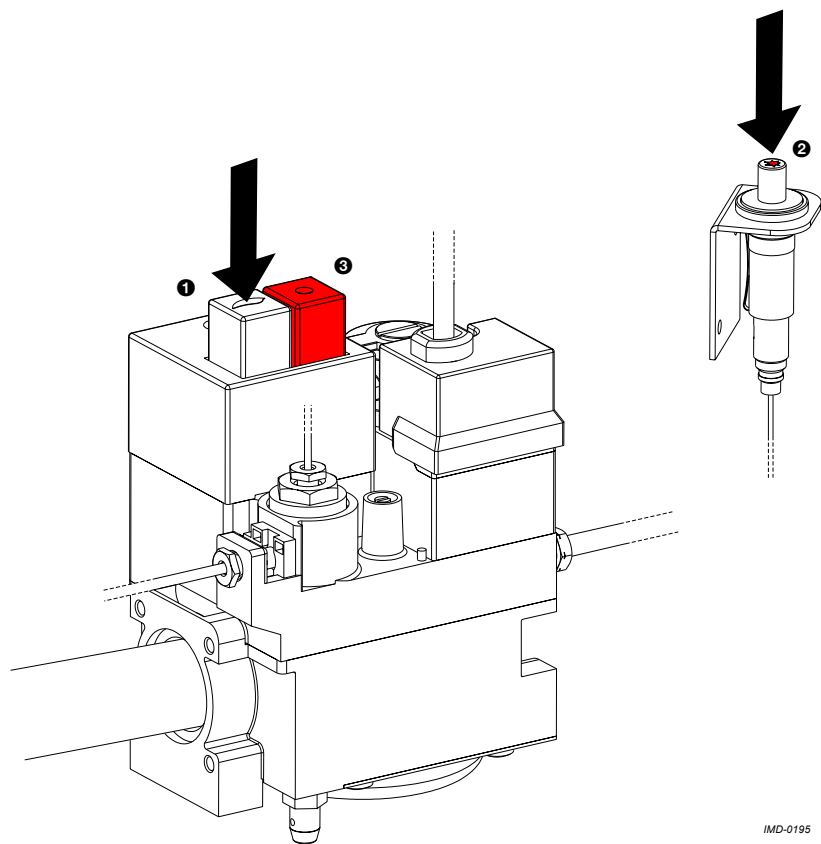

IMD-0195

**Figure 7.1** Gas control

## 7.2 Starting up

Start-up the appliance as follows:

1. Fill the appliance. See chapter '[4 Filling and draining](#)'.
2. Open the gas valve. See '[Figure 4.1 Connection diagrams](#)'.
3. Switch on the power to the appliance using the main switch between the appliance and the power supply.

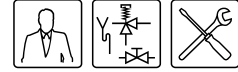

- Begin the ignition procedure by pressing and holding the white button ❶ on the gas control while repeatedly pressing the piezo igniter ❷ until the pilot flame ignites. See [Figure 7.1](#). The pilot flame can be viewed through the inspection window above the burner tray.

#### **Warning**

If the pilot flame goes out during the ignition procedure or warm-up cycle, you must wait 5 minutes before repeating the ignition procedure.

- Keep the white button pressed in for about 30 seconds before carefully releasing it. The pilot flame should now stay lit.
- Set the appliance to the 'ON mode' by switching the **I/O/II**-switch on the control panel to the **I position**.
- Set the desired water temperature using the control thermostat. See paragraph '[5.5 Control thermostat](#)'.

If there is a heat demand, the heating cycle will run its course. See paragraph '[7.4 The appliance's heating cycle](#)'.

## 7.3 Shutting down

You can:

- [Shutting the appliance down for brief periods \("OFF mode"\)](#).
- [Disconnecting the appliance from the mains](#).
- [Shutting the appliance down for a longer period](#).

### 7.3.1 Shutting the appliance down for brief periods ("OFF mode")

To shut down the appliance for a brief period, you can set the appliance in "OFF-mode". Activate frost protection by switching the **I/O/II**-switch on the control panel to the **0 position**. The pilot flame will remain on.

### 7.3.2 Disconnecting the appliance from the mains

When servicing, the appliance must be electrically disconnected. The correct procedure is as follows:

- Put the appliance in OFF mode by setting the **I/O/II**-switch to the **0 position**.
- Switch off the power to the appliance by setting the main switch between the appliance and the mains power supply to position 0.
- The pilot flame will remain on, but you can extinguish it if required by pressing the red button ❸ on the gas control. See [Figure 7.1](#).

#### **Caution**

These operating states of "OFF mode" and "Disconnected" are advisable only if there is no risk of frost. If frost can be expected, you will need to drain the appliance, see paragraph '[7.3.3 Shutting the appliance down for a longer period](#)'.

### 7.3.3 Shutting the appliance down for a longer period

Drain the appliance if you are shutting it down for a longer period of time. Proceed as described in paragraph '[4.3 Draining the appliance](#)'.

## 7.4 The appliance's heating cycle

The appliance's heating cycle is activated as soon as the measured water temperature ( $T_{\text{water}}$ ) falls below the threshold value ( $T_{\text{set}}$ ).  $T_{\text{set}}$  can be adjusted using the control thermostat, for example position 3 ( $\pm 60^{\circ}\text{C}$ ).

The heating cycle runs in turn through the following states:

- HEAT DEMAND;
- IGNITION;
- RUNNING;

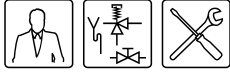

## ***The appliance's heating cycle***

The complete cycle is explained in the example set out below.

1. The control thermostat sensor measures the water temperature ( $T_{\text{water}}$ ). If  $T_{\text{water}}$  drops below the set temperature ( $T_{\text{set}}$ ), there is a heat demand and the control thermostat will close. This will cause the gas control to open.
2. Once the gas control is open, the pilot burner will ignite the gas flow.
3. The appliance is now running. This means that actual heating has started. When the water is up to temperature, the heat demand cuts out. The gas control closes and the burner tray is extinguished (the pilot flame stays lit).
4. The appliance is now said to be in a state of rest, and waiting until  $T_{\text{water}}$  once again falls below  $T_{\text{set}}$ .

With any subsequent heat demand, the heating cycle will resume from step 1.

# 7

## Starting up and shutting down

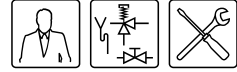

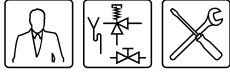

# 8 Troubleshooting

## 8.1 Introduction

This chapter covers the following errors:

General errors

- [Gas smell](#).
- [Water leakage](#).
- [Explosive ignition](#).
- [Poor flame profile](#).
- [Power Anode \(optional\)](#)
- [No hot water](#)
- [Insufficient hot water](#).

General errors cannot be displayed on the control panel, but these errors usually do not cause the hot water supply to fail, neither fully nor partially.

If the hot water supply should fail, this is termed an error state. See paragraph ['6.4 Error states'](#).

If the hot water supplied is insufficient, this is usually caused by an incorrect setting, or some temporary problem.

The following pages provide troubleshooting tables for each type of error.

**Warning**

Maintenance should only be carried out by a qualified service and maintenance engineer.

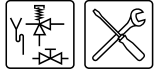

## 8.2 Troubleshooting table for general errors

Table 8.1 General errors Page 1 of 2

Symptom	Cause	Solution	Remarks
Gas smell	Gas leak	<b>Warning</b> Immediately close the main gas valve.	<b>Note</b> Immediately contact your installer or local gas company.
		<b>Warning</b> Do not operate any switches.	
		<b>Warning</b> No naked flames.	
		<b>Warning</b> Ventilate the room where the appliance is located.	
Water leakage	Leakage from a water connection (threaded).	Tighten the threaded connection.	If the leak has not been repaired, consult your installer.
	Leakage from another water appliance or pipe nearby.	Trace the leak.	
	Leakage from the appliance's tank.	Consult the supplier and/or manufacturer.	
	Condensation	Before drawing off hot (too much) tap water, wait until the water in the heater has reached the set temperature.	

**Warning**

Maintenance should only be carried out by a qualified service and maintenance engineer.

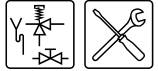
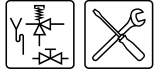

**Table 8.1** General errors Page 2 of 2

Symptom	Cause	Solution	Remarks
<b>Explosive ignition</b>  <b>Poor flame profile</b>	Incorrect supply pressure and/or burner pressure.	Set the correct supply pressure and/or burner pressure, see ' <a href="#">3.12 Checking the supply pressure and burner pressure</a> '.	If ignition is not improved, consult your installer.
	Contaminated burner	Clean the burner. See ' <a href="#">9.4.2 Cleaning the burners</a> '	
	Contaminated injector	Clean the injector. See ' <a href="#">9.4.3 Cleaning the injectors</a> '	
	Inadequate air supply	Improve the air supply by better ventilating the room in which the appliance is located.	
<b>Power Anode (optional)</b>  • <b>Indicator lamp is red</b>	<ul style="list-style-type: none"> <li>Anodes not making contact with the water;</li> <li>Break in one of the cables;</li> <li>Anode poorly earthed;</li> </ul>	<ol style="list-style-type: none"> <li>Check that the water heater is full of water;</li> <li>Check that the Power Anode is properly connected, see '<a href="#">appendix 'A SCT electrical diagram'</a>';</li> <li>Check to see that all connections are properly made;</li> <li>Check all cables for breaks and replace if any are found.</li> </ol>	If the error cannot be corrected, consult your installer.
• <b>Indicator lamp is off</b>	No power supply to the potentiostat;	Check the power supply	

**Warning**

Maintenance should only be carried out by a qualified service and maintenance engineer.

**8.3 Troubleshooting table 'no hot water'**

If the appliance fails to supply any hot water, there are several possible causes.  
Consult the table ['Table 8.2 No hot water'](#).

**Table 8.2 No hot water**

Symptom	Cause	Solution	Remarks
<b>No ignition (Pilot flame LIT)</b>	No power	<ol style="list-style-type: none"> <li>1. Check that the mains switch is ON.</li> <li>2. Check the voltage across the main switch. The measured voltage must be 230V AC +15% -10%.</li> </ol>	If ignition is not rectified, consult your installer
<b>Pilot flame OUT</b>	Pilot flame blown out	<ol style="list-style-type: none"> <li>1. Start up the appliance. See paragraph <a href="#">'7.2 Starting up'</a>.</li> </ol>	If the error cannot be resolved or is persistent, contact your installer.
	No Gas:	<ol style="list-style-type: none"> <li>1. Check that the gas valve is open.</li> <li>2. Check that gas control opens (clicking of the gas control).</li> <li>3. Check the gas control wiring.</li> </ol>	
	The safety thermostat has cut out	<ol style="list-style-type: none"> <li>1. The safety thermostat has cut out correctly: <ul style="list-style-type: none"> <li>- Check whether the control thermostat is working.</li> <li>- Check whether the high-limit thermostat is working.</li> <li>- Check that the circulation pump (if present) is working.</li> </ul> </li> <li>2. The safety thermostat has cut out without apparent reason: <ul style="list-style-type: none"> <li>- Check whether the thermostat may be broken.</li> <li>- Check whether the thermostat sensor may be broken.</li> </ul> </li> </ol>	



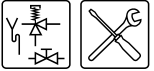

### Warning

Maintenance should only be carried out by a qualified service and maintenance engineer.

## 8.4 Troubleshooting table 'insufficient hot water'

If the appliance fails to supply any hot water, there are several possible causes.  
Consult the table '[Table 8.3 Insufficient hot water](#)'

**Table 8.3 Insufficient hot water**

Symptom	Cause	Solution	Remarks
Insufficient hot water	Water temperature setting ( $T_{set}$ ) too low	Set the control thermostat to a higher setting. See paragraph ' <a href="#">5.5 Control thermostat</a> '.	
	Hot water supply used up	<ol style="list-style-type: none"><li>1. Reduce the rate of hot water consumption. Allow the appliance enough time to heat up the water.</li><li>2. If this error occurs regularly, check whether the high-limit thermostat is cutting in/out. If so, check that the circulation- and/or shunt pumps are working properly.</li></ol>	If the error has not been rectified, and no other cause can be found, disconnect the appliance from the mains, shut off the gas valve and alert your installer.

---

**Warning**

Maintenance should only be carried out by a qualified service and maintenance engineer.

---

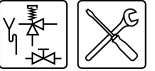



# 9 Maintenance

## 9.1 Introduction

---

### Caution

Maintenance may only be carried out by an approved service and maintenance engineer.

---

At each service, the appliance undergoes maintenance both on the water side and on the gas side. The maintenance should be carried out in the following order.

1. [Preparing for maintenance](#);
2. [Water-side maintenance](#);
3. [Gas-side maintenance](#);
4. [Finalising maintenance](#).

---

### Note

Before ordering spare parts, take a moment to write down the appliance type and model, and the full serial number of the appliance. Only with this information can you be sure to receive the correct spare parts. These details can be found on the rating plate.

---

## 9.2 Preparing for maintenance

To test whether all components are still working properly, you should complete the following steps:

1. Check the supply pressure and burner pressure and adjust these, where necessary. See paragraph '[3.12 Checking the supply pressure and burner pressure](#)'. Also check that this is running properly during the warm-up cycle. See paragraph '[7.4 The appliance's heating cycle](#)'.
2. Check that all components of the flue gas system are properly attached.
3. Test the operation of the overflow valve of the cold water supply arrangement. The water should spurt out.
4. Test the overflow operation of the T&P valve. The water should spurt out.
5. Check the wastewater pipes of the overflow valves and remove any scale deposits that may be present.
6. Drain the appliance. See paragraph '[4.3 Draining the appliance](#)'.

## 9.3 Water-side maintenance

### 9.3.1 Introduction

The following steps should be carried out on the water side:

1. [Checking the anodes](#).
2. [Descaling and cleaning the tank](#).

### 9.3.2 Checking the anodes

Timely replacement of the anodes extends the service life of the appliance. The anodes that are present must be replaced as soon as they are 60% or more used up (take this into consideration when determining the maintenance frequency).



**Take care**  
The draught diverter  
and the cover may be  
hot.

1. Remove the flue gas thermostat connector from the connector on the unit.
2. Disconnect the draught diverter from the flue gas discharge.
3. Undo the screws on the draught diverter.
4. Remove the draught diverter from the appliance.
5. Undo the screws on the cover on the top of the appliance.
6. Remove the cover from the appliance.
7. Remove the sealing ring from the tank.
8. Undo the anodes using the appropriate tool.
9. Check the anodes, and if necessary, replace them.
10. Now also check the flue baffles. Replace them, if necessary. See paragraph '9.4.4 Checking the flue baffles'.
11. Fit a new sealing ring around the edge of the tank and replace the cover.
12. Reconnect the flue gas thermostat connector to the connector on the unit.



#### Note

This unit is also appropriate for the use of Power Anodes. These are available as an accessory and can be ordered separately. Please check your Power Anode instructions for correct use or consult your installer.

### 9.3.3 Descaling and cleaning the tank

Scale and chalk deposits prevent effective conduction of the heat to the water. Periodic descaling prevents build-up of these deposits. This increases the service life of the appliance, and also improves the heating process. Take the rate at which scale is formed into account, when determining the maintenance frequency.

1. Remove the cover plate ❶ in the outer jacket. See [Figure 9.1](#).
2. Undo the bolts.
3. Remove the cover and the rubber O ring.
4. Inspect the tank and remove any contamination.
5. Remove the chalk deposits using Borcoil<sup>(1)</sup>.
6. Close the cleaning opening.  
Use a new rubber O ring for this.

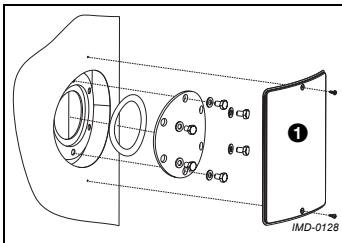

Figure 9.1 Cleaning opening

## 9.4 Gas-side maintenance



**Take care**  
The burners may be  
hot.

### 9.4.1 Introduction

On the gas side the following steps should be carried out:

1. [Cleaning the burners](#).
2. [Cleaning the injectors](#).
3. [Checking the flue baffles](#).

### 9.4.2 Cleaning the burners

1. Detach the burners.
2. Carefully remove any contamination present on the burners.
3. Re-attach the burners.

1. State recommends the use of Borcoil, because the composition of this product is known. Borcoil can be ordered from State.



### **9.4.3 Cleaning the injectors**

1. Detach the injectors.
2. Remove any contamination present in the injectors.
3. Re-attach the injectors.

### **9.4.4 Checking the flue baffles**



**Take care**

The flue baffles may be hot.

1. Complete steps 1 to 7 from paragraph '[9.3.2 Checking the anodes](#)'.
2. Remove the flue baffles from the appliance.
3. Check the flue baffles for rust, and remove any rust which is present.
4. Check the flue baffles for wear, and replace any worn flue baffles.
5. Fit a new sealing ring around the edge of the tank and replace the cover.
6. Reconnect the flue gas thermostat connector to the connector on the unit.

## **9.5 Finalising maintenance**

To finalise the maintenance carry out the following steps:

1. Fill the appliance. See paragraph '[4.2 Filling the appliance](#)'.
2. Re-start the appliance. See '[7.2 Starting up](#)'.



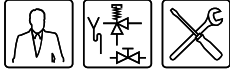

# 10 Warranty (Certificate)

## 10.1 General warranty

If within one year of the original installation date of a water heater supplied by State, following verification, and at the sole option of State, a part or component, (with exclusion of the tank) proves to be defective or does not function correctly due to manufacturing and/or material defects, State shall replace or repair this part or component.

## 10.2 Tank warranty

If within 3 years of the original installation date of a water heater supplied by State, following inspection, and at the sole option of State, the steel, glass-lined tank proves to be leaking due to rusting or corrosion occurring on the water side, State shall provide an entirely new water heater of equivalent size and quality. The warranty period given on the replacement water heater shall be equal to the remaining warranty period of the original water heater that was supplied. Despite what is stated earlier in this article, the warranty shall be limited to one year after the original installation date, in the event that unfiltered or softened water is used, or remains behind in the water heater.

## 10.3 Installation and conditions of use

The warranty set out in article 1 and 2 will only apply under the following conditions:

- a. the water heater is installed with under strict adherence to the installation instructions of State for the specific model, and the relevant local authority installation and building codes, rules and regulations in force;
- b. the water heater remains installed at the original site of installation;
- c. the installation is exclusively used with drinking water, which at all times can freely circulate (a separately installed heat exchanger is mandatory for heating salt water or corrosive water);
- d. the tank is safeguarded against harmful scaling and chalk deposits by means of periodic maintenance;
- e. the water temperatures in the heater do not exceed the maximum setting of the thermostats, which form a part of the water heater;
- f. the water pressure and/or heat load do not exceed the maximum values stated on the water heater rating plate;
- g. the water heater is installed in a non-corrosive atmosphere or environment;
- h. the water heater is connected to a cold water supply arrangement, which is: approved by the relevant authority; with sufficient capacity for this purpose; supplying a pressure no greater than the working pressure stated on the water heater; and where applicable, fitted with a temperature and pressure relief valve approved by the relevant authority, compliant with the installation instructions of State pertaining to the specific model of water heater, and under adherence to the relevant local authority installation and building codes, rules and regulations in force;
- i. the anodes are replaced and renewed no later than when 60% used up.

## 10.4 Exclusions

The warranty set out in article 1 and 2 will not apply, in the event of:

- a. damage to the water heater caused by an external factor;

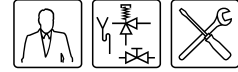

- b. misuse, neglect (including frost damage), modification, incorrect and/or unauthorised use of the water heater and any attempt to repair leaks;
- c. contaminants of other substances having been allowed to enter the tank;
- d. the conductivity of the water being less than 125  $\mu\text{S}/\text{cm}$  and/or the hardness (alkaline-earth ions) of the water being less than 1.00 mmol/lit (see [Table 3.3](#));
- e. unfiltered, recirculated water flowing through or being stored in the water heater;
- f. any attempts at repair to a defective water heater other than by an approved service engineer.

#### 10.5 Scope of the warranty

The obligations of State pursuant to the specified warranty do not extend beyond free delivery from the Veldhoven warehouse of the replacement parts or components or water heater. Shipping, labour, installation and any other costs associated with the replacement will not be accepted by State.

#### 10.6 Claims

A claim on grounds of the specified warranty must be submitted to the dealer from whom the water heater was purchased, or to another authorised dealer for the products of State Water Heaters. Inspection of the water heater as referred to in articles 1 and 2 shall take place in one of State's laboratories.

#### 10.7 Limitation of liability

State grants no other warranty or guarantee over its water heaters nor the (parts or components of) water heaters supplied for replacement, other than the warranty expressly set out in this Certificate.

State is not liable for damage to persons or property caused by (parts or components, or the steel glass-lined tank of) a (replacement) water heater that it has supplied under the terms of this warranty, nor on any other grounds.



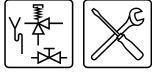

# A SCT electrical diagram

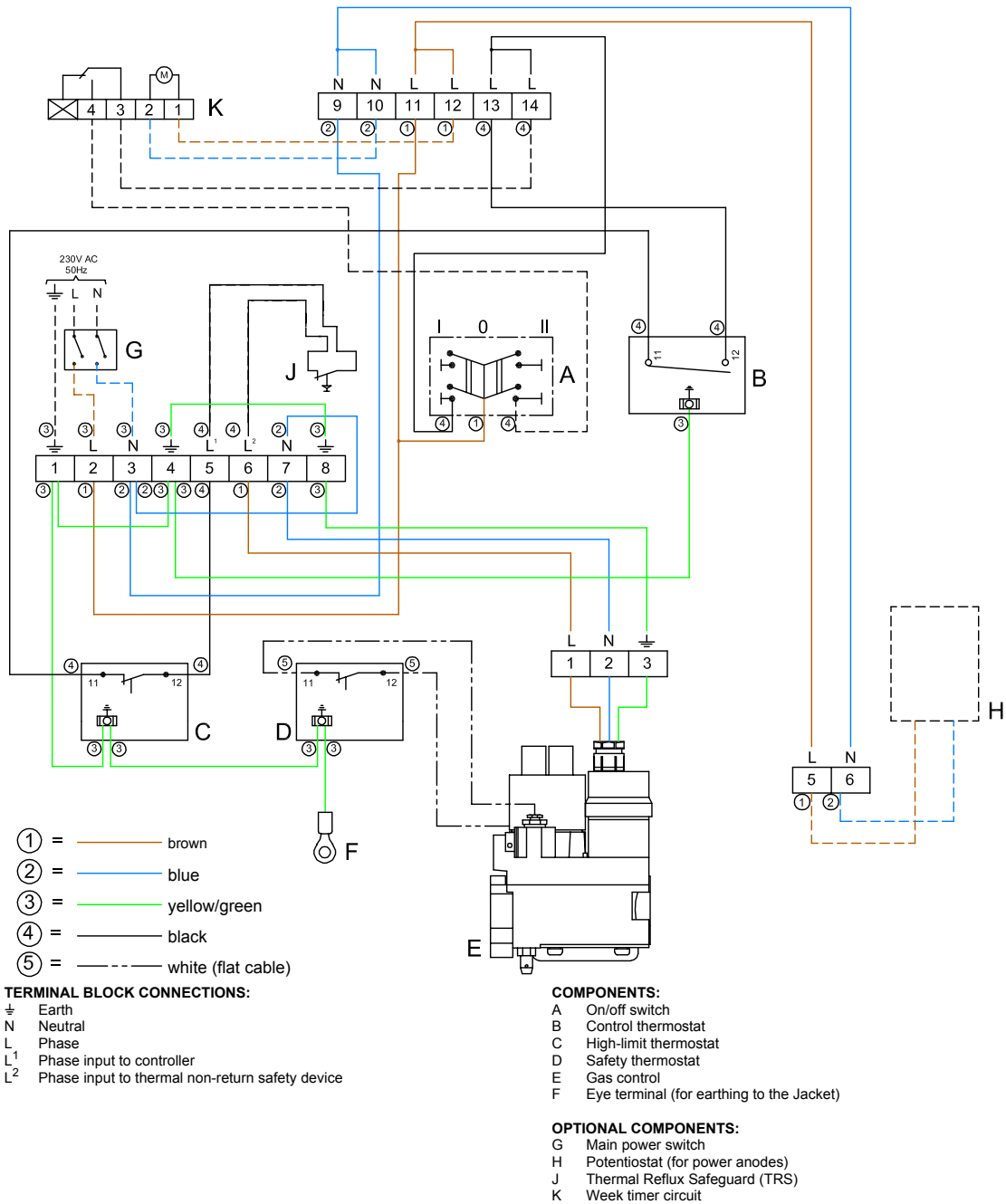
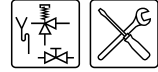
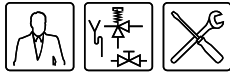

Figure A.1 SCT electrical diagram

# A

## SCT electrical diagram





# IX Index

<b>A</b>	ambient temperature - - - - - 21	<b>H</b>	heat requirement - - - - - 50
	appliance		humidity - - - - - 21
	categories - - - - - 9	<b>I</b>	
	general operation - - - - - 14		icons - - - - - 44
	protection - - - - - 15		ignite - - - - - 50
	warm-up cycle - - - - - 15		in operation - - - - - 50
<b>B</b>			installer - - - - - 10
	brand names - - - - - 3	<b>L</b>	
	burner pressure - - - - - 35		liability - - - - - 3
<b>C</b>		<b>M</b>	
	calcium deposition - - - - - 60		main switch - - - - - 32
	checking		mains voltage - - - - - 32
	pre-pressure, burner pressure - - - - - 35		maintenance
	claims - - - - - 64		anode - - - - - 59
	condensation drainage		burner - - - - - 60
	connecting - - - - - 27		carry out - - - - - 59
	connecting		complete - - - - - 61
	condensation drainage - - - - - 27		descaling - - - - - 60
	electrical - - - - - 31		injector - - - - - 61
	gas - - - - - 28		on the gas side - - - - - 60
	the circulation pipe - - - - - 27		on the water side - - - - - 59
	the cold water side - - - - - 26, 27		preparation - - - - - 59
	the hot water side - - - - - 26		scaling - - - - - 60
	connecting the circulation pipe - - - - - 27	<b>O</b>	
	connecting the cold water side - - - - - 26, 27		operating states - - - - - 47
	connecting the hot water side - - - - - 26	<b>P</b>	
	content of document - - - - - 11		packaging - - - - - 21
	control thermostat - - - - - 44		pre-pressure - - - - - 35
	convert to another gas - - - - - 32		protection - - - - - 15
<b>D</b>			putting into operation - - - - - 49
	data		putting out of operation
	electrical - - - - - 24		disconnecting from the mains - - - - - 50
	descaling - - - - - 60		lengthy period - - - - - 50
	dimensions - - - - - 22		short period - - - - - 50
	drain - - - - - 40	<b>S</b>	
<b>E</b>			safety - - - - - 16
	electrical connecting block - - - - - 31		scaling - - - - - 60
	electrical connection - - - - - 31		service - - - - - 10
	environmental conditions - - - - - 21		service engineer - - - - - 10
<b>F</b>			shunt pump - - - - - 26, 27
	filling - - - - - 40		specifications - - - - - 22
	floor load - - - - - 22		stacking - - - - - 26, 27
	forms of notation - - - - - 11		state
<b>G</b>			DISCONNECTED - - - - - 47
	gas		HEAT REQUIREMENT - - - - - 50
	converting - - - - - 32		IGNITE - - - - - 50
	gas connection - - - - - 28		IN OPERATION - - - - - 50
	general operation - - - - - 14		OFF - - - - - 47
			ON - - - - - 47
			supply cable - - - - - 32

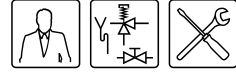

symbol	
installer - - - - -	10
service engineer - - - - -	10
user - - - - -	10

<b>T</b>	
target groups - - - - -	10
trademarks - - - - -	3

<b>U</b>	
user - - - - -	10

<b>W</b>	
warm-up cycle - - - - -	-15, 50
warranty - - - - -	-63
exclusions - - - - -	-63
general - - - - -	-63
installation and conditions of use - - - - -	-63
scope- - - - -	-64
tank- - - - -	-63
water	
composition- - - - -	-22
stacking- - - - -	-26, 27