

# users guide

## isar + programmer

Your Ideal users guide

### HE24, HE30, HE35

When replacing any part on this appliance use only spare parts that you can be assured conform to the safety and performance specification that we require. Do not use reconditioned or copy parts that have not been clearly authorised by Ideal Boilers.

August 2009 UIN 202675 A05

**i** BOILERS *Ideal*  
The High Efficiency Pioneers

## isar HE24, HE30, HE35

(Natural Gas Only)

Destination Countries: GB, IE

HE24 G.C. Appliance No. 47-348-43

HE30 G.C. Appliance No. 47-348-44

HE35 G.C. Appliance No. 47-348-45

### Introduction

The **isar + programmer** is a wall mounted, room sealed, condensing combination boiler providing both central heating and instantaneous domestic hot water. Featuring full sequence automatic spark ignition and fan assisted combustion.

A 7 day programmer is built into the boiler capable of 3 timed periods per day.

Due to the high efficiency of the boiler, condensate is produced from the flue gases and this is drained to a suitable disposal point through the plastic waste pipe at the lower rear of the boiler. A condensate 'plume' will also be visible at the flue terminal.

### Safety

#### Current Gas Safety (Installation & Use) Regulations or rules in force.

In your own interest, and that of safety, it is the law that this boiler must be installed by a Gas Safe Registered Engineer, in accordance with the above regulations.

In IE, the installation must be carried out by a Registered Gas Installer (RGI) and installed in accordance with the current edition of I.S. 813 "Domestic Gas Installations", the current Building Regulations and reference should be made to the current ETCI rules for electrical installation.

**It is essential that the instructions in this booklet are strictly followed, for safe and economical operation of the boiler.**

### Electricity Supply

**This appliance must be earthed.**

**Supply: 230 V ~ 50 Hz. The fusing should be 3A.**

Connection must be made in a way that allows complete isolation of the electrical supply such as a double-pole switch, having a 3mm (1/8") contact separation in both poles, serving only the boiler and system controls. Alternatively, a 3-pin UNSWITCHED socket may be used. The means of isolation must be accessible to the user after installation.

### Important Notes

- This appliance must not be operated without the casing correctly fitted and forming an adequate seal.
- If the boiler is installed in a compartment then the compartment MUST NOT be used for storage purposes.
- If it is known or suspected that a fault exists on the boiler then it MUST NOT BE USED until the fault has been corrected by a Gas Safe Registered Engineer or in IE a Registered Gas Installer (RGI).
- Under NO circumstances should any of the sealed components on this appliance be used incorrectly or tampered with.

- This appliance is not intended for use by persons (including children) with reduced physical, sensory or mental capabilities, or lack of experience and knowledge, unless they have been given supervision or instructions concerning use of the appliance by a person responsible for their safety.
- Children should be supervised to ensure that they do not play with the appliance.

In cases of repeated or continuous shutdown a Gas Safe Registered Engineer or in IE a Registered Gas Installer (RGI) should be called to investigate and rectify the condition causing this and carry out an operational test. Only the manufacturers original parts should be used for replacement.

### Minimum Clearances

Clearances of **165mm (6 1/2")** above, **100mm (4")** below, **5mm (1/4")** at the sides and **450mm (17 3/4")** at the front of the boiler casing must be allowed for servicing.

The minimum front and bottom clearance allowed when built into a cupboard is 5mm.

### To light the boiler. Refer to Frame 1

The boiler incorporates a factory fitted programmer, refer to page 5 onwards of these instructions for setting the programmer before continuing.

1. CHECK THAT THE ELECTRICITY SUPPLY TO THE BOILER IS OFF.
2. Set the mains ON/OFF switch (A) to OFF.
3. Ensure that all DHW taps are turned off.
4. Switch ON the electricity supply to the boiler and check that the room thermostat is set to call for heat.
5. Set the mains ON/OFF switch to ON.

The boiler will commence the ignition sequence, first supplying heat to pre-heat the domestic hot water and then to the central heating, if required.

**Note.** In normal operation the time programmer display (B) will show the time of day.

Standby - no demand for heat.

☐ CH being supplied.

⚡ DHW being supplied.

During normal running the flame symbol will remain illuminated.

**Note.** If the boiler fails to light after 3 attempts the fault code "LF" will be displayed.

Press the select button (C) for greater than 3 seconds then release. The boiler will repeat the ignition sequence. If the boiler still fails to light consult a Gas Safe Registered Engineer or in IE a Registered Gas Installer (RGI).

All Gas Safe Registered Engineers carry a Gas Safe Register ID card, and have a registration number. Both should be recorded in the **Benchmark** Commissioning Checklist. You can check your installer by calling Gas Safe Register direct on 0800 4085500

**Ideal Stelrad Group** is a member of the Benchmark scheme and fully supports the aims of the programme. Benchmark has been introduced to improve the standards of installation and commissioning of central heating systems in the UK and to encourage the regular servicing of all central heating systems to ensure safety and efficiency.

**THE BENCHMARK SERVICE INTERVAL RECORD MUST BE COMPLETED AFTER EACH SERVICE**



## Operation

### Winter conditions - i.e. CH and DHW required.

The boiler will fire and supply heat to the radiators but will give priority to DHW on demand during timed on periods.

The DHW pre-heat will operate as described under 'Summer conditions' during periods when there is no call for CH.

### Summer conditions - i.e. DHW only required.

Set the CH mode to OFF.

The boiler will fire periodically for a few seconds to maintain the DHW calorifier in a pre-heated condition during a timed on period. The average time period between firing is 90 minutes. This may vary considerably due to the surrounding ambient temperature of the boiler. The boiler will fire whenever there is a demand for DHW during a timed on period.

**Note.** *The pump will operate briefly as a self-check once every 24 hours, regardless of system demand.*

## Control of water temperature

### Domestic Hot Water

The DHW temperature is limited by the boiler controls to 65°C maximum at low draw-off rate, adjustable via the DHW temperature set point within the programmer.

Due to system variations and seasonal temperature fluctuations DHW flow rates/temperature rise will vary, requiring adjustment at the draw off tap : the lower the rate the higher the temperature, and vice versa.

### Central Heating

The boiler controls the central heating radiator temperature to a maximum of 82°C, adjustable via the CH temperature set point adjustment within the programmer.

## To shut down the boiler

### 1. For short periods

Set the mains ON/OFF switch (A) to OFF

### 2. For longer periods

Set the mains ON/OFF switch (A) to OFF, and switch the electricity supply to OFF. For longer periods the entire system should be drained.

## To relight the boiler

Repeat the procedure detailed in 'To light the boiler'.

## Frost protection

If frost protection is required then the boiler should be left powered. The boiler has built in boiler frost protection to ensure that the water in the heat exchanger does not drop below 4°C.

If external frost protection is required, a kit can be purchased to support an external frost thermostat.

## Boiler overheat thermostat

This thermostat will shut down the boiler in the event of overheating. Should this occur a fault code "LA" will be displayed. Press the select button (C) for greater than 3 seconds and the boiler will relight.

If the fault recurs, turn off the boiler and consult a Gas Safe Registered Engineer or in IE a Registered Gas Installer (RGII).

## Flame failure

Should this occur a fault code "LF" will be displayed.

Press the select button (C) for greater than 3 seconds and the boiler will relight.

If the fault recurs, turn off the boiler and consult a Gas Safe Registered Engineer or in IE a Registered Gas Installer (RGII).

## Loss of system water pressure

The gauge (E) indicates the central heating system pressure. If the pressure is seen to fall below the original installation pressure of 1-2 bar over a period of time then a water leak may be indicated. In this event conduct the re-pressurising procedure (see Trouble Shooting - Problem 4). If unable to do so or if the pressure continues to drop a Gas Safe Registered Engineer or in IE a Registered Gas Installer (RGII) should be consulted.

**DO NOT FIRE THE BOILER IF THE PRESSURE HAS REDUCED TO ZERO FROM THE ORIGINAL SETTING.**

## Condensate Drain

The condensate drain (D) must not be modified or blocked.

Blockage of the condensate drain, caused by debris or freezing, can cause automatic shutdown of the boiler.

If freezing is suspected and the pipe run is accessible an attempt may be made to free the obstruction by pouring hot water over the exposed pipe and clearing any blockage from the end of the pipe. If this fails to remedy the problem the assistance of a Gas Safe Registered Engineer or in IE a Registered Gas Installer (RGII) should be sought.

## Escape of gas

Should a gas leak or fault be suspected contact your local gas supplier without delay.

**Do NOT search for gas leaks with a naked flame.**

## Cleaning

For normal cleaning simply dust with a dry cloth.

To remove stubborn marks and stains, wipe with a damp cloth and finish off with a dry cloth.

**DO NOT use abrasive cleaning materials.**

## Maintenance

The appliance should be serviced at least once a year by a Gas Safe Registered Engineer or in IE a Registered Gas Installer (RGII).

## BOILER CONTROLS

### Legend

- A. Boiler ON/OFF switch
- B. Display
- C. Select button
- D. Condensate drain
- E. Pressure gauge

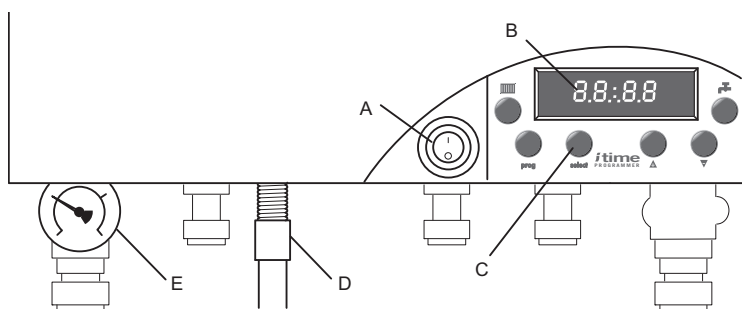



**CAUTION. To avoid the possibility of injury during the installation, servicing or cleaning of this appliance care should be taken when handling edges of sheet steel components.**

## POINTS FOR THE BOILER USER

**Note.** In line with our current warranty policy we would ask that you check through the following guide to identify any problems external to the boiler prior to requesting a service engineers visit. Should the problem be found to be other than with the appliance we reserve the right to levy a charge for the visit, or for any pre-arranged visit where access is not gained by the engineer.

### TROUBLESHOOTING - TYPICAL NON PRODUCT FAULTS

	Problem	Solution
1	Boiler is not working for central heating or hot water.	<ul style="list-style-type: none"> <li>Check there is power to the boiler – switch (A) to the ON position and the time of day is displayed on the controls. Ensure that the programmer is in an ON period if turned or set to ON.</li> <li>If the time of day is not displayed then not a boiler fault – contact your installer/service company.</li> </ul>
2	Boiler is not working for central heating or hot water but attempts to fire by going through 3 ignition attempts. Display shows 'L:F' (flashing).	<ul style="list-style-type: none"> <li>Press select (reset) button (C) for greater than 3 seconds to repeat ignition sequence.</li> <li>Check gas supply (try another appliance – cooker/fire etc.) – If no gas supply then not a boiler fault – contact gas supplier.</li> <li>Check condensate pipe is not blocked or frozen. If blocked clear blockage – if not possible to check contact your installer.</li> </ul>
3	Boiler is not working for central heating or hot water and the display shows 'L:A' (flashing).	<ul style="list-style-type: none"> <li>Press select (reset) button (C) for greater than 3 seconds, the boiler should then re-light. If fault recurs this indicates an overheat condition. The boiler should be turned off and your installer contacted.</li> <li>Check if <b>ALL</b> radiators have thermostatic radiator valves fitted. If they have contact your installer.</li> </ul>
4	Boiler is not working for central heating or hot water and the display shows 'H:A' (flashing).	<ul style="list-style-type: none"> <li>Check pressure gauge on boiler shows a minimum of 1 bar. If not re-pressurise via the filling loop to 1 bar (if unsure contact your installer), turn off the tap on the filling loop and turn the on/off switch (A) off and then back on again to reset the boiler. If unable to do so or if the pressure continues to drop after filling then contact your installer.</li> <li>Check if <b>ALL</b> radiators have thermostatic radiator valves fitted. If they have contact your installer.</li> </ul>
5	Boiler will not fire for central heating.	<ul style="list-style-type: none"> <li>If already set to an 'ON' period then check the programmer by setting to permanent ON if boiler then fires – Contact your installer to rectify the programmer.</li> <li>Check room thermostat by turning fully up, if  is not displayed on the user controls then contact your installer.</li> </ul>
6	Boiler comes on for domestic hot water without a tap being opened - the display shows  .	<ul style="list-style-type: none"> <li>Check for dripping / dribbling taps or showers – turn fully off.</li> <li>Check for leaks from the domestic hot water pipework and if found contact your installer.</li> </ul>
7	Boiler fires occasionally for approx. 2 minutes - the display shows  .	<ul style="list-style-type: none"> <li>This is a normal function of the boiler, during an ON period, to periodically pre heat the plate heat exchanger to optimise delivery time for domestic hot water to taps or showers.</li> </ul>

The nature of all combination boilers is to heat up water directly from the incoming mains water supply directly through the boiler to supply domestic hot water at the stated flow rates, (as shown in the boiler installation instructions), to achieve a 35°C temperature rise. As the ambient temperature of the cold main varies during the summer and winter months it is likely in the colder winter months that the flow rate will need to be reduced at the outlet taps to achieve the same temperatures achieved in the warmer summer months. **This is not a fault with the appliance but is relevant to the varying temperature of the incoming cold mains water supply.**

## ISAR HE PROGRAMMER USER REFERENCE GUIDE

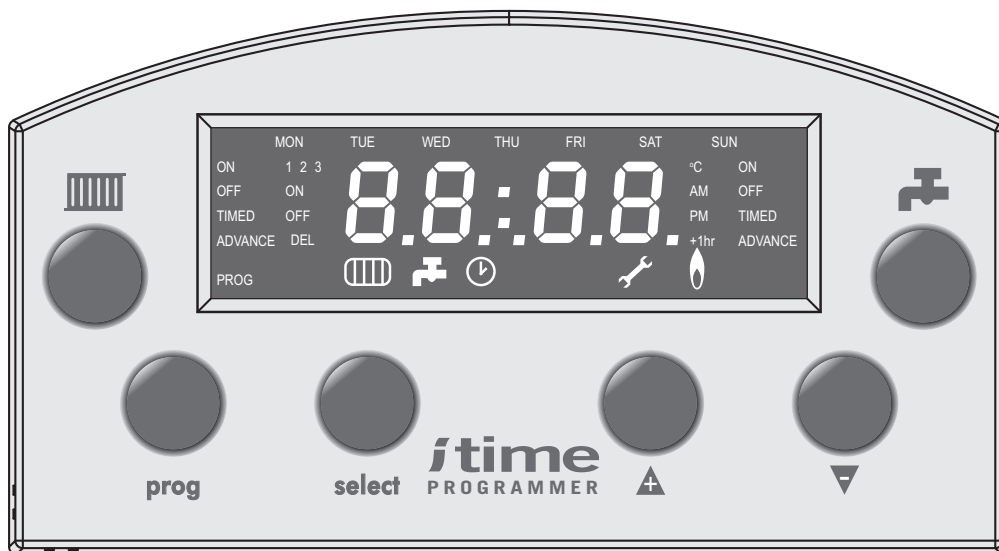

### INTRODUCTION

The isar HE programmer allows the user to set the times at which they want the boiler to run for Central Heating (CH) and Domestic Hot Water (DHW). It is a full, 7 day, programmer allowing setting of 3 ON-OFF periods per day on MON-FRI, SAT-SUN, MON-SUN, or individual days. It also has a built in 12/24 Hr clock and allows adjustment of the set points for DHW temperature and CH radiator temperature.

The user interface (UI) consists of 6 buttons and a backlit Liquid Crystal Display (LCD). The buttons are broken down into two function categories. The first is that of changing the operating mode of the boiler or programmer and the second is in the setting of parameters, time, time periods, temperatures, etc.

### GMT / BST ADJUSTMENT

The clock can be easily adjusted between GMT and BST by pressing the "UP" (▲) button for 3 seconds.

**NOTE.** *The time is pre-set before leaving the factory. If on receipt of the boiler the time shown is incorrect by  $\pm 1$  hour (due to difference between GMT and BST), simply press the "UP" (▲) button for 3 seconds.*

### ADVANCE FUNCTION

A programme start or end can be brought forward by pressing either the heating or DHW buttons.

### PRE-HEAT

DHW pre-heat will be disabled during DHW off periods.

### BATTERY BACKUP

If there is a power failure to the boiler all programme times are stored and the real time clock is maintained using battery back up.

**NOTE.** *Pages 6 to 12 are the itime Programmer Instructions.*

**SEE PULL OUT SHEET AT REAR OF THIS BOOKLET FOR EASE OF USE**

1 PROGRAMMING MODE STRUCTURE

Once the programming mode is entered the structure is as shown:

 are the UP and DOWN buttons

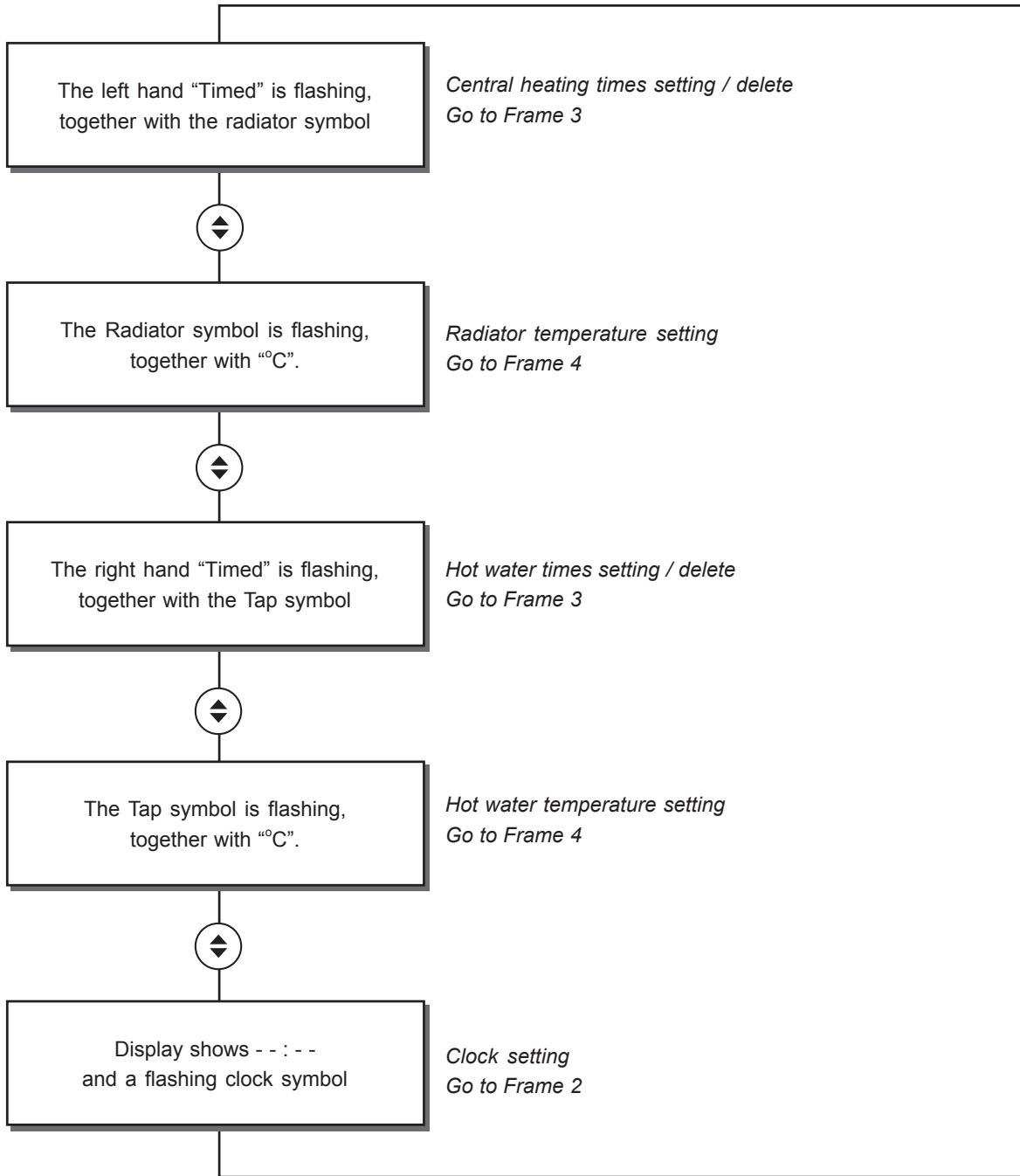

**Note.** Using the down arrow key will navigate the structure in reverse order.

2 SETTING THE DAY AND TIME

DISPLAY SHOWS time / day  
and backlight is OFF

**P** Press 'PROG' button *briefly*

DISPLAY SHOWS time / day  
and backlight is ON

**P** Press 'PROG' button *briefly*

The left hand "Timed" is flashing, together  
with the Radiator symbol and the word  
"PROG" is showing

**↕** Press down arrow once or  
up arrow four times until. .

Display shows -- : --  
and a flashing clock symbol

**S**

The clock symbol becomes steady and  
one of the days is flashing

**↕**

Use Up and Down buttons  
to reset to current day

The day symbol becomes steady  
and the 12 / 24 hr symbol flashes

**S**

**↕**

Use Up and Down buttons  
to select 12 or 24hr mode for display

The hours digits flash

**S**

**↕**

Use Up and Down buttons  
to reset to current hour

The hours digits become steady  
and the minutes digits flash

**S**

**↕**

Use Up and Down buttons  
to reset to current minute

The 'am' or 'pm' symbol flashes  
(in 12 hr mode only)

**S**

**↕**

Use Up and Down buttons  
to set 'am' or 'pm' as appropriate

The clock now displays the current day  
and time in 12 or 24 hr mode

**S**

**P** is the PROG button

**S** is the SELECT button

**↕** are the UP and DOWN buttons



# ITIME PROGRAMMER

## 3 PROGRAMMING THE HEATING (OR HOT WATER) PERIODS

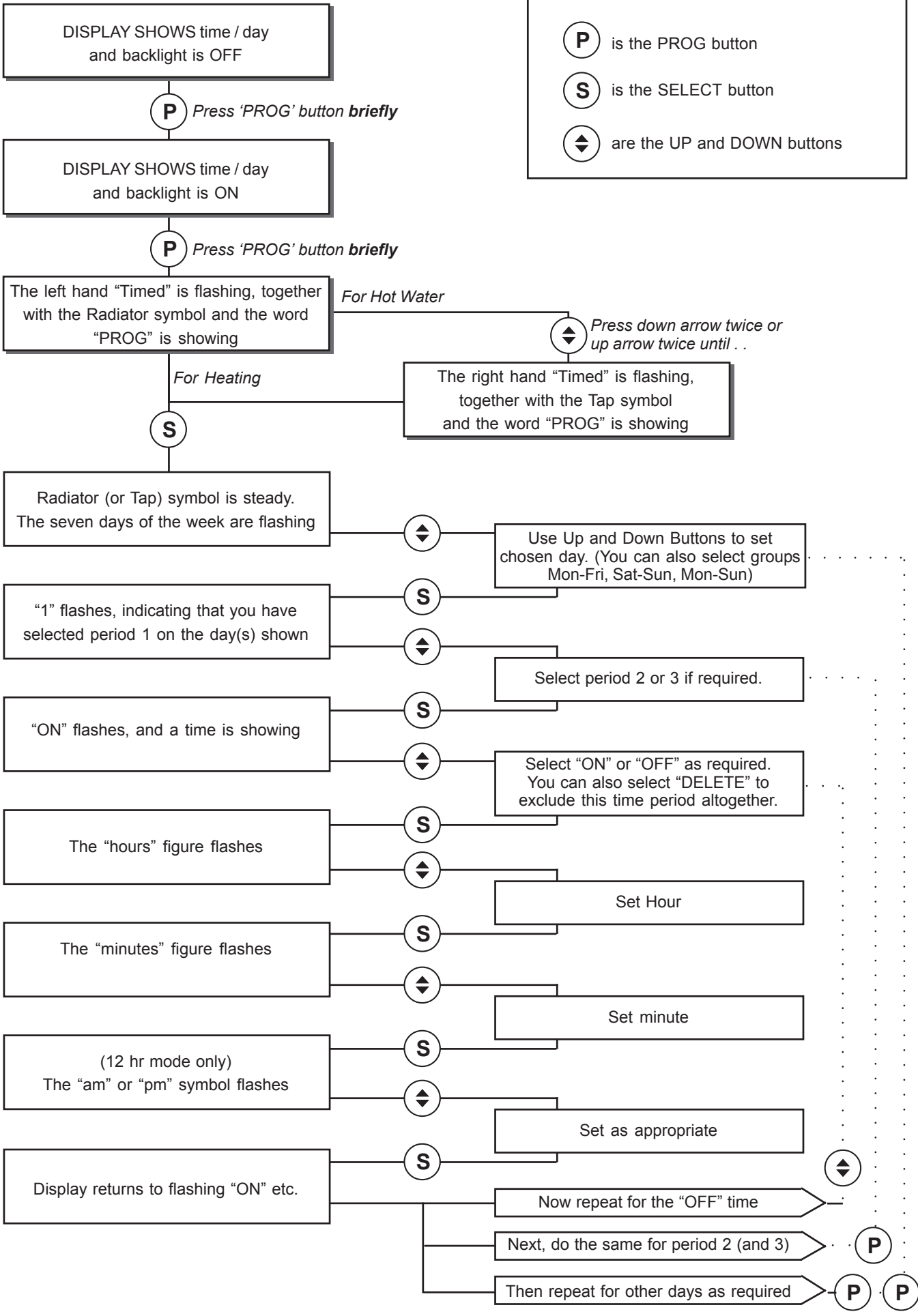



## 4 SETTING THE HOT WATER TEMPERATURE\*

DISPLAY SHOWS time / day  
and backlight is OFF

**P** Press 'PROG' button **briefly**

DISPLAY SHOWS time / day  
and backlight is ON

**P** Press 'PROG' button **briefly**

The left hand "Timed" is flashing, together  
with the Radiator symbol and the word  
"PROG" is showing

**↕** Press down arrow twice or  
up arrow three times until. .

The Tap symbol is flashing  
together with "°C"

**S**

The Tap symbol is steady.  
The temperature figure flashes

**↕**

Use Up and Down buttons to set value.  
Hot water delivery temperature  
can be set from 40 to 65°C

**S**

Change accepted.  
Display reverts to normal

**P** is the PROG button

**S** is the SELECT button

**↕** are the UP and DOWN buttons

*\*For systems with underfloor heating or other systems requiring a maximum flow temperature different to 82°C, the maximum radiator temperature can be set in a similar manner to "Setting the HW Temperature".*

## 5 QUICK REVIEW OF PROGRAMMED TIMES AND TEMPERATURES

**Note.**  
*This section cannot be used to amend the settings, see Frames 3 and 4.*

- P** is the PROG button
- S** is the SELECT button
- ◀▶** are the UP and DOWN buttons

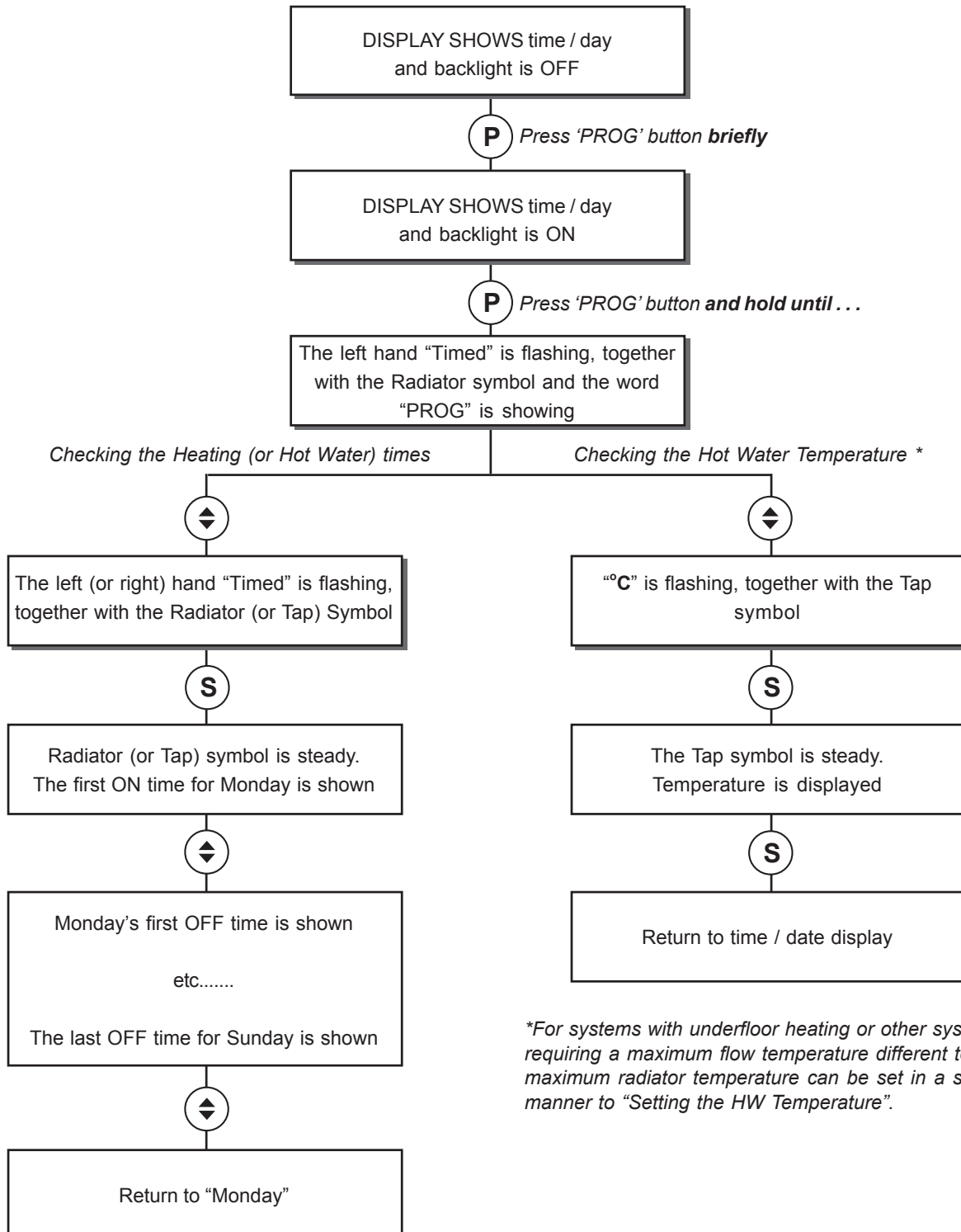

*\*For systems with underfloor heating or other systems requiring a maximum flow temperature different to 82°C, the maximum radiator temperature can be set in a similar manner to "Setting the HW Temperature".*

## 6 PRESET PROGRAM TIMES AND TEMPERATURES

The programmer comes with preset Central Heating and Hot Water times and temperatures.

These can be amended using the appropriate procedures. The times can be deleted if they are not required (refer to Frame 8).

### Central Heating Periods:

#### MON-FRI

Period 1 ON 06:30  
Period 1 OFF 08:30

Period 2 ON 17:00  
Period 2 OFF 22:30

Period 3 ON — : —  
Period 3 OFF — : —

#### SAT-SUN

Period 1 ON 07:30  
Period 1 OFF 10:00

Period 2 ON 12:00  
Period 2 OFF 14:00

Period 3 ON 17:00  
Period 3 OFF 22:30

### Hot Water Periods:

#### MON-SUN

Period 1 ON 06:30  
Period 1 OFF 00:00

Period 2 ON — : —  
Period 2 OFF — : —

Period 3 ON — : —  
Period 3 OFF — : —

Radiator Temperature 82 °C

Hot Water Temperature: 60 °C

## 7 FAULT FINDING

If the display shows a 'spanner' symbol, and the time or temperature indication is replaced by a 2-symbol Fault Code, then the boiler is being prevented from running because of adverse conditions.

Those Codes beginning with 'H' are temporary and will reset when the fault condition has (been) cleared.

Those Codes beginning with 'L' are 'permanent', causing a 'Lockout' situation.

When one of these faults has been cleared, the boiler should be reset by pressing the 'Select' button for greater than 3 seconds.

The Select button is the equivalent of the small Reset button on boilers without programmers.

Further details of the Lockout Codes are in the main boiler instruction book, Fault Finding section.

## 8 CLEARING THE PRESET TIMES

The programmer comes with preset time periods for Central Heating and Hot Water. These can be individually cleared prior to user programming using the following sequence.

- P** is the PROG button
- S** is the SELECT button
- ◀▶** are the UP and DOWN buttons

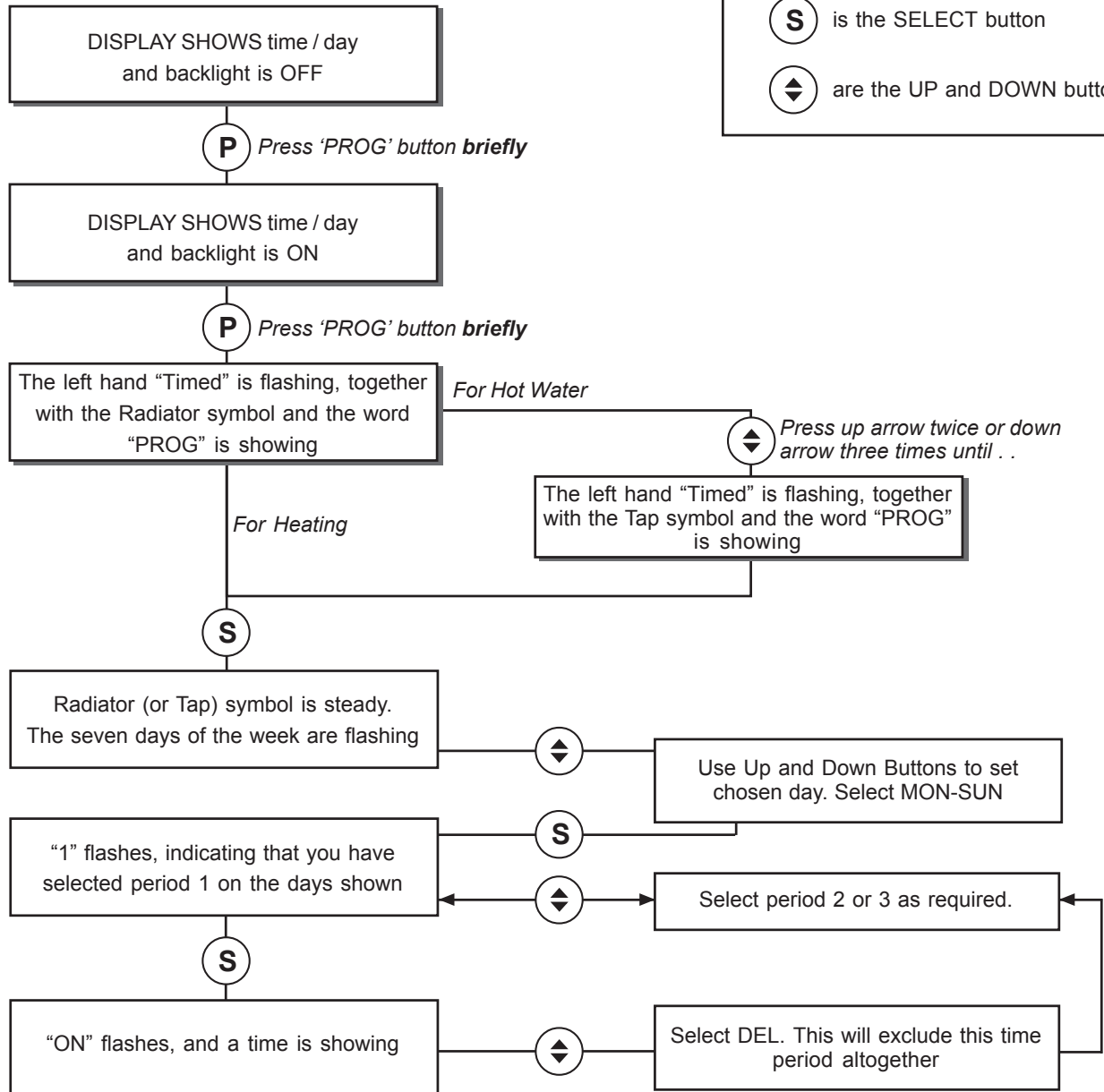

# ITIME PROGRAMMER - CONTROLS AND DISPLAY

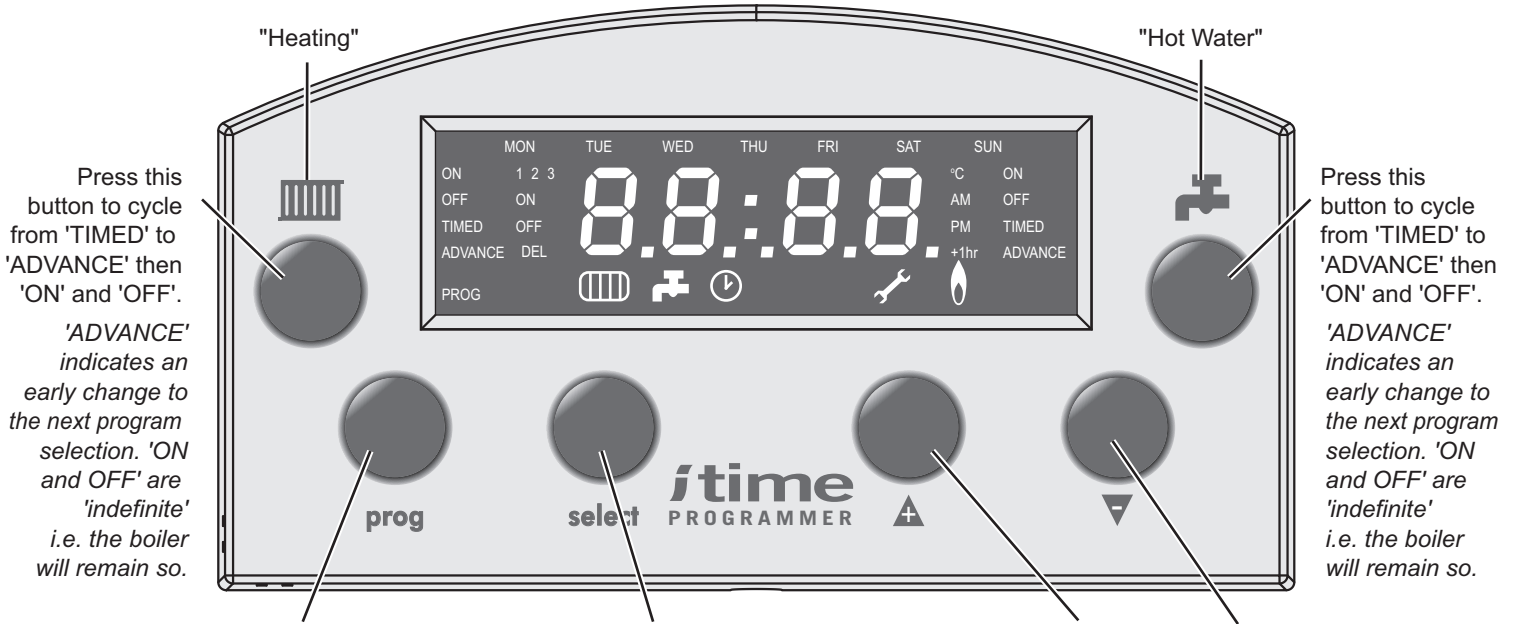

The 'Prog' button is used to change into Programming mode, in order to check programs and to reset the clock. (See Frame 2 to 9)

The 'Select' button is normally used to make choices within menus. It selects whichever option on the display is flashing.

The 'Up' and 'Down' buttons are used to amend values and move around within menus.

**NB** - The Prog button also functions in program mode as a back key and an abort key (press and hold).

**NB** - The Select button also functions as a Reset button for fault conditions. (See Frame 7)

**NB** - The 'Up' button also makes the change to and from Summer-time. For this function, press for 3 seconds.

These symbols relate to the times being programmed 1, 2 and 3 are the daily periods. ON and OFF are the functions. DEL is used to clear a programmed period.

