

## FITTING THE PROGRAMMER

If surface wiring has been used, remove the knockout/insert from the bottom of the programmer to accommodate it. Loosen the two 'captive' retaining screws on the top of the unit. Now fit the programmer to the HCL9 backplate, line the lugs on the programmer with the flanges on the HCL9 backplate. Swing the top of the programmer into position ensuring that the connection blades on the back of the unit locate into the terminal slots in the backplate. Tighten the two 'captive' retaining screws to fix the unit securely, then switch on the mains supply.

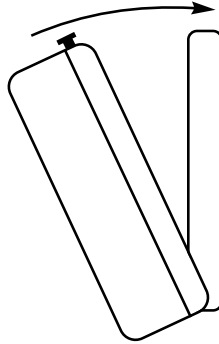

END VIEW OF 425 ELECTRO-MECHANICAL PROGRAMMER

The tappets can now be set to suit the User's requirements.  
Please refer to the User's Guide provided.

## GENERAL INFORMATION

Before handing over the installation to the user, always ensure that the system responds correctly on all control programmes and that other electrically operated equipment and controls are correctly adjusted.

EXPLAIN HOW TO OPERATE THE CONTROLS AND HAND OVER THE USERS OPERATING INSTRUCTIONS TO THE USER.

## SPECIFICATION: CORONET - DIADEM - TIARA

### MODELS:

**Coronet:** Single Circuit 13(6)A 230V AC  
**Diadem:** Double Circuit 6(2.5)A 230V AC  
**Tiara:** Double Circuit 6(2.5)A 230V AC

**Contact type:** Micro dis-connection(Voltage free, Coronet and Tiara only)

**Motor Supply:** 230-240V AC 50Hz

**Double Insulated**

**Enclosure Protection:** IP 20

**Max. Operating Temperature :** Coronet 35°C  
Diadem / Tiara 55°C

**Dirt protection:** Normal situations.

**Independently mounted control for surface mounting.**

**Purpose of Control:** Electronic Time Switch

**Operating time limitation:** Continuous

**Type 1 Action**

**Case material:** Thermoplastic, flame retardant

**Dimensions:** 153mm x 112mm x 33mm

**Clock:** 24 hour

**Programme selection:** 24 Hours, On all day, Twice, Off

**Operating periods per day:** Two

**Override:** Instant advance

**Backplate:** HCL9 - 9 Pin terminal connection

INSTALLATION INSTRUCTIONS  
CORONET - DIADEM - TIARA



HORSTMANN

The 425 Range of traditional Electro-mechanical Programmers offer a simple yet effective way of controlling your environment. The twin circuit Diadem and Tiara will also allow you to have independent control of Hot water and Central heating.

INSTALLATION AND CONNECTION SHOULD ONLY BE CARRIED OUT BY A SUITABLY QUALIFIED PERSON AND IN ACCORDANCE WITH THE CURRENT EDITION OF THE IEE WIRING REGULATIONS.

**WARNING : ISOLATE MAINS SUPPLY BEFORE COMMENCING INSTALLATION**

## FITTING THE HCL9 BACKPLATE

Once the HCL9 backplate has been removed from the packaging please ensure the programmer is re-sealed to prevent damage from dust, debris etc.

The HCL9 Backplate should be fitted with the wiring terminals located at the top and in a position which allows the relevant clearances around the programmer. (See diagram)

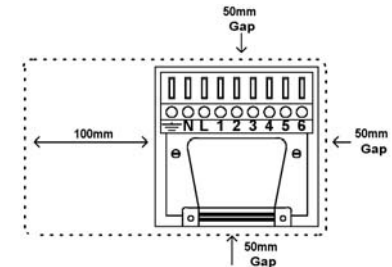

## DIRECT WALL MOUNTING

Offer the plate to the wall in the position where the programmer is to be mounted, remembering that the HCL9 Backplate fits to the right hand end of the programmer.

Mark the fixing positions through the slots in the HCL9 Backplate(Fixing centres 60.3mm), drill and plug the wall, then secure the plate in position. The slots in the HCL9 Backplate will compensate for any misalignment of the fixings.

## WIRING BOX MOUNTING

The HCL9 Backplate may be fitted directly on to a single gang steel flush wiring box complying with BS4662, using two M3.5 screws.

425 Electro-Mechanical Programmers are suitable for mounting on a flat surface only, they must not be positioned on a surface mounted wall box or on unearthed metal surfaces.

## ELECTRICAL CONNECTIONS

All necessary electrical connections should now be made. Flush wiring can enter from the rear through the aperture in the HCL9 Backplate. Surface wiring can only enter from beneath the programmer and must be securely clamped.

The mains supply terminals are intended to be connected to the supply by means of fixed wiring. The recommended cable sizes are 1.0mm<sup>2</sup> or 1.5mm<sup>2</sup> for a Diadem/Tiara and 1.5mm<sup>2</sup> for a Coronet.

Email: sales@horstmann.co.uk  
Website: www.horstmann.co.uk

Horstmann Controls Ltd,  
a division of Horstmann Group Ltd.  
Bristol  
BS4 1UP

t:0117 9788 773 - f:0117 9788 701



LEAFLET No P27673  
ISSUE 16

# ELECTRICAL CONNECTIONS

425 Electro-Mechanical Programmers are double insulated and do not require an Earth connection but an Earth terminal is provided on the HCL9 Backplate for terminating any cable Earth conductors. Earth continuity must be maintained and all bare Earth conductors must be sleeved. Ensure that no conductors are left protruding outside the central space enclosed by the HCL9 Backplate.

## INTERNAL WIRING DIAGRAMS

### CORONET

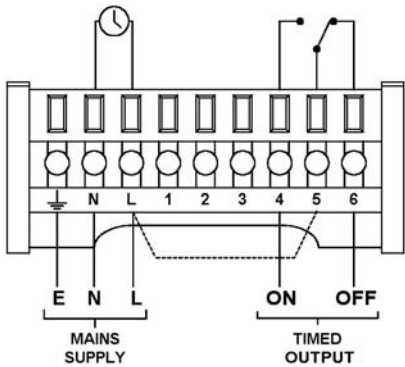

When used to control MAINS VOLTAGE SYSTEMS Terminals L and 5 should be electrically linked by means of a suitable piece of sleeved conductor. When used to control EXTRA LOW VOLTAGE SYSTEMS these links MUST NOT be fitted.

### DIADEM / TIARA

Indicator light shown is only on the 425 Diadem.

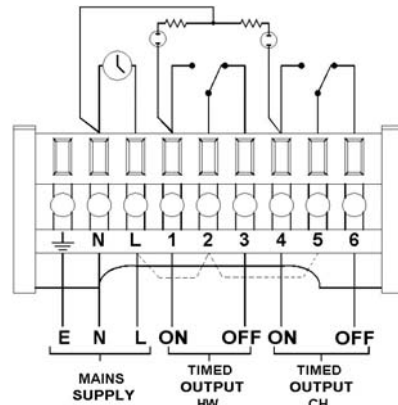

When used to control MAINS VOLTAGE SYSTEMS Terminals L,2 and 5 should be electrically linked by means of a suitable piece of sleeved conductor. When used to control EXTRA LOW VOLTAGE SYSTEMS these links MUST NOT be fitted.

## INTERLOCKING - DIADEM AND TIARA ONLY.

If a Diadem or Tiara is used on Gravity Hot water/Pumped Central heating systems the selector slides must be interlocked for correct programme selection. This is achieved by rotating the interlock located at the top of the HW programme slide.

This is achieved by first selecting Twice on the HW selector slide, then selecting the Off position on the CH selector slide, this will reveal the screwdriver slot in the interlock. Position the screwdriver in the slot and rotate anti-clockwise until the slot is almost horizontal (a stop will prevent the interlock from being turned too far).

Check for correct operation of programme slides. This should result in the HW selector slide moving up to match any CH selection (twice, all day and 24 Hours). When the CH slide switch is returned to any of the lower position (all day, twice and off), the HW slide switch will stay in the uppermost position reached and will have to be manually moved to the desired new position.

# TYPICAL WIRING DIAGRAMS

Example circuit diagrams for some typical installations are shown below. These diagrams are schematic and should be used as a guide only.

**Please ensure that all installations comply with the current IEE regulations.**

For reasons of space and clarity not every system has been included and the diagrams have been simplified, for instance some Earth connections have been omitted.

Other control components shown in the diagrams i.e. Valves, RoomStats etc are general representations only. However the wiring detail can be applied to the corresponding models of most manufacturers e.g. Horstmann, Honeywell, Danfoss Randall, ACL Drayton etc.

**Cylinder and Room Thermostat Key:**

**C = Common CALL = Call for heat or break on rise SAT = Satisfied on rise N = Neutral**

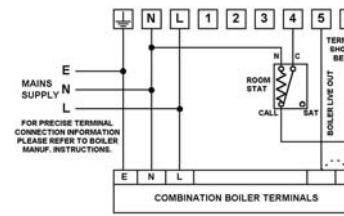

425 Coronet controlling typical combination boiler installation via room thermostat.

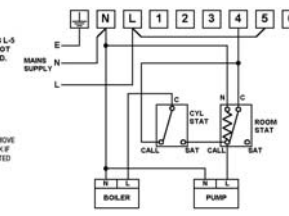

425 Coronet controlling gravity Hot water with pumped Heating via room stat and cylinder stat.

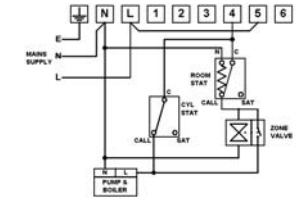

425 Coronet controlling fully pumped system via room stat, cylinder stat and using a 2 port spring return valve with auxiliary switch on heating circuit.

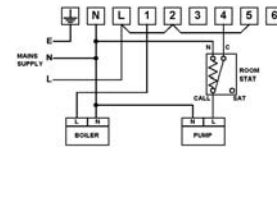

425 Diadem/Tiara controlling gravity Hot water with pumped Heating via room stat.

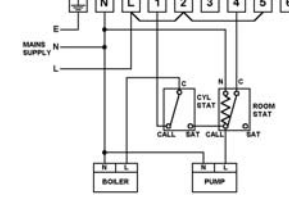

425 Diadem/Tiara controlling gravity Hot water with Pumped Heating via room stat and cylinder stat.

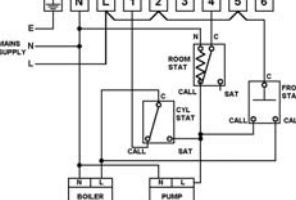

425 Diadem/Tiara controlling gravity Hot water with pumped Heating using a 2 port spring return valve with auxiliary switches via a room stat and cylinder stat.

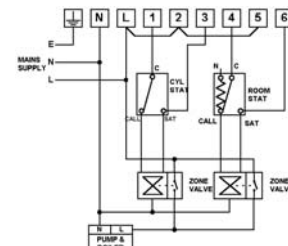

425 Tiara controlling fully pumped system using two motorised 2 port valves with auxiliary switches via room stat and cylinder stat.

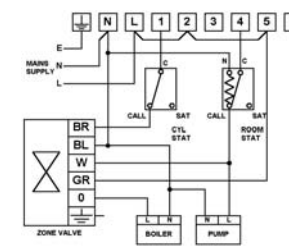

425 Diadem/Tiara controlling gravity Hot water with pumped heating using a 2 port spring return valve with changeover auxiliary switch on the Hot water circuit

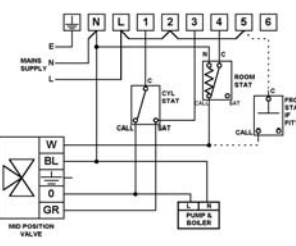

425 Tiara controlling fully pumped system using a mid position valve via room stat and cylinder stat.