



Vizo

24/28

Condensing wall
mounted Combination
Boiler

Installation, Servicing
& User Instructions



Natural Gas / LPG

HEATLINE™ Vizo24 / Vizo28 Condensing Combination Boilers

British Gas Service Listing

Vizo 24 Condensing Combination Boiler G.C.No 47-157-08

Vizo 28 Condensing Combination Boiler G.C.No 47-157-09

The HEATLINE™ range of heating boilers is manufactured from high quality materials, enabling reliability and optimum performance.

HEATLINE™ is committed to the continual development of their appliances to ensure their customers benefit from the latest advances in combustion technology and energy savings.

Type test for purpose of Regulation 5 certified by:

Notified Body IMQ **51BP2727** CE Directives 90/396/EEC
51BP2728DR CE Directives 92/42/EEC

Product/Production certified by:

Notified Body IMQ **51BP2727** CE Directives 90/396/EEC
51BP2728DR CE Directives 92/42/EEC

The manufacturer, in the continuous process to improve his products, reserves the right to modify the data expressed in the present documentation at any time and without prior notice.

The present documentation is an informative support and it cannot be considered as a contract towards third parties.



'Benchmark' Log Book

As part of the industry-wide initiative the Vizo24/Vizo28 boilers come complete with an Installation, Commissioning and Service Record Log Book. Please read the Log book carefully and in accordance with current regulations complete all sections relevant to the appliance and installation. The details within the Log Book will be required in the event of any warranty work.

On completion, the Log Book must be left with the end user and the relevant sections completed on each subsequent Service visit.

Contents

Section	Page
Preface	3
1. Installation Regulations	3
The Signs on Box	4
The Signs on Boiler	4
2. Technical Data	5
3. Boiler Characteristics	7
4. Operation	8
5. General Installation	9
6. Appliance Siting	11
7. Flue Terminal Location	11
8. General Flue Info	13
9. Electrical Connections	14
10. Boiler Installation	16
11. Gas Supply	19
12. Filling the System	19
13. Control Panel Functions	19
14. Commissioning	20
15. Onboard Adjustments	21
16. Safety Devices	22
17. Routine Servicing	23
18. Component Replacement	25
19. Gas Type Conversion	32
20. Fault Finding Chart	33
Appendix	
Spare Parts List	37
User Instructions	38

Preface

The Heatline™ gas fired, condensing combination boiler meets the requirements of regulations and is deemed to meet the requirements of:

- Gas Appliance Directive 90/396/EEC
- Efficiency Directive 92/42/EEC
- Low Voltage Directive 73/23 EEC (modified from 93/68)
- Electromagnetic Compatibility Directive 89/396 EEC (modified from 93/68)

Heatline™ declares that the materials used in the manufacturer of this appliance are non-hazardous and that no substances harmful to health are contained within the appliance.

The Vizo24 / Vizo28 must be installed in accordance with these instructions and the regulations currently in force. Read these instructions fully before installing or using the appliance.

Heatline™ accepts no responsibility for unsatisfactory performance of the appliance or flue arising from the failure to comply with the installation instructions.

If the boiler is sold or installed to another customer, all documents must be transferred from existing customer to the new one.

Warnings

Heat Line™ accepts no responsibility for the unsatisfactory performance of the appliance or flue arising from the failure to comply with the installation and user instructions. Incorrect installation could invalidate your guarantee and may lead to prosecution.

If the appliance is re-sold or installation transferred the appliance must be re-registered with Heatline in order to maintain the guarantee.

The boiler must be installed in accordance with these instructions and the regulations currently in force. Read these instructions carefully before installing or using the appliance.

1. Installation Regulations

- 1.1. This appliance must be installed in accordance with the Rules in Force by a registered C.O.R.G.I. engineer in accordance with the Gas Safety (Installation and Use) Regulations. Failure to install this appliance correctly may invalidate your guarantee and may lead to prosecution.
- 1.2. Your C.O.R.G.I. registered engineer should carry a C.O.R.G.I. ID card containing their registration number, which should be recorded in your BENCHMARK Log Book, which is supplied with the Instructions. You can check the validity of this ID number by contacting C.O.R.G.I. on 0870 401 2300.
- 1.3. This appliance must be installed in accordance with the Gas Safety (Installation and Use) Regulations, current Building Regulations, Building Standards (Scotland), I.S.813 Installation of Gas Appliances (Ireland), IEE Wiring Regulations (BS 7671), Health and Safety Document No. 635 (Electricity at Work Regulations) and Local Water Authority Bye Laws.
- 1.4. On installation the following British Standards must also be considered:
 - BS 6798 Specification for installation of gas fired hot water boilers of rated input not exceeding 70kW.
 - BS 5449 Central heating for Domestic Premises.
 - BS 5546 Installation of gas hot water supplies for domestic purposes.
 - BS 5440 Flues and Ventilation for gas appliances of rated input not exceeding 70kW (Part 1 Flues)
 - BS 5440 Flues and Ventilation for gas appliances of rated input not exceeding 70kW (Part 2 Air Supply)
 - BS 6891 Installation of low pressure gas pipe-work installations up to 28mm (RI).
- 1.5. Due to the manufacturer's continuous improvement policy the manufacturer reserves the right to change any specification of the appliance or make modifications to these instructions, which meet current regulations at the time of print. However, the instructions must not be taken as overriding statutory requirements.
- 1.6. To ensure reliability and continued performance ensure that other components in the system are also approved to relevant standards and that the appliance and system is adequately protected and maintained on an annual basis.

For further information or advice contact Heatline™ Service & Technical Enquiries in UK on **0870 777 8318**, Ireland on **01 466 4664** or E-mail via our web site www.heatline.co.uk.

The Signs on Box



The sign of approval the Vizo24 & Vizo28 Boilers have been certified by GASTEC Italy.



This is a fragile piece of equipment: Do not drop.



Avoid getting the box damp or wet.



The packed appliances may be stacked five high.



Do not crush the packaging as this may damage the appliance.



Store the appliance upright as indicated on the box.

Handling This appliance is heavy, truck if possible and obtain assistance if required.

To remove the appliance:

1. Carefully slit or remove the sealing tape being careful not to scratch the appliance door.
2. Fully open the carton lid and remove any instructions and components.
3. Read the instructions carefully before installation of the appliance.
4. Roll the carton onto its open face.
5. Lift the carton free of the inner packaging.
6. Remove the mounting bracket and valve package.
7. Stand the boiler on its base within the styrene block and remove the top packaging piece.
8. If you wish to remove the styrene base lie the appliance on its back to do so.



This picture shows the terminal block, which is located at the bottom left hand side of the control panel cover, to which a voltage free room thermostat may be fitted. **NOTE:** This is a voltage free connection and no power must be applied to these terminals. For mains powered thermostat connection, see section 9.5.



Warning! High Voltage: This sign is located on the back of the control box housing warning of high voltages within the control box. Turn off and isolate the appliance before removing this cover.

NOTE: Take care as there may be residual voltage within some components



Potentiometer Cover: Removal of the cover, which is found on the back of the control box, gives access to the adjustment potentiometers. **NOTE:** Do not make any adjustments without reading the instructions carefully.

The Signs on Boiler

2. Technical Data

		VIZO 24 (24 kW)	VIZO 28 (28 kW)
Heat Input (max)	kW	25,7	28,5
Heat Output (max)	kW	24,82	27,47
Heat Input (min)	kW	10,12	15
Heat Output (min)	kW	9,27	14,26
Useful efficiency at 100% load	%	96,6	96,4
Useful efficiency at 30% load	%	99,09	101
Burner injector	mm.	1,23 NG 0,76 LPG	1,20 NG 0,76 LPG
Burner Pressure (Natural Gas)	mbar	Max 12,7 Min 2,0	Max 11,6 Min 3,5
Burner Pressure (Propane)	mbar	Max 27,9 Min 4,4	Max 27,7 Min 6,1
Power Supply	Input	220-240V-50Hz	
Max. power consumption	Watt	164	
Level of Protection	IPX 4 D		
Case Dimensions 24kW	mm	330d x 405w x 720h	
Case Dimensions 28kW	mm	330d x 430w x 720h	

		VIZO 24 (24 kW)	VIZO 28 (28 kW)
Maximum heating temperature	°C	85	85
Max. domestic hot water temperature	°C	64	64
Operating pressure (Bar)	PMS Nominal (Min)	3 1.5 (0,8)	3 1.5 (0,8)
Domestic water supply pressure (Bar)	PMS (Min)	8 (0,25)	8 (0,25)
Expansion Vessel Capacity	Litres	7	7
Expansion Vessel Pre-charge Pressure	bar	0,5	0,5
Domestic Water Supply Output at 35° C ΔT	L/min	9,92	11,3
Air Intake Pipe Diameter	mm	100	100
Flue Pipe Diameter	mm	60	60
Max. Flue Length (Horizontal)	m	2.5 60/100 7.0 80/125	2.5 60/100 7.0 80/125
Max. Flue Length (Vertical)	m	3.0 60/100 8.0 80/125	3.0 60/100 8.0 80/125
Equivalent Length 45° Bend	m	1.0	1.0
Equivalent Length 90° Bend		1.5	1.5
Net weight	Kg	37	38
Gross Weight	kg	40	41

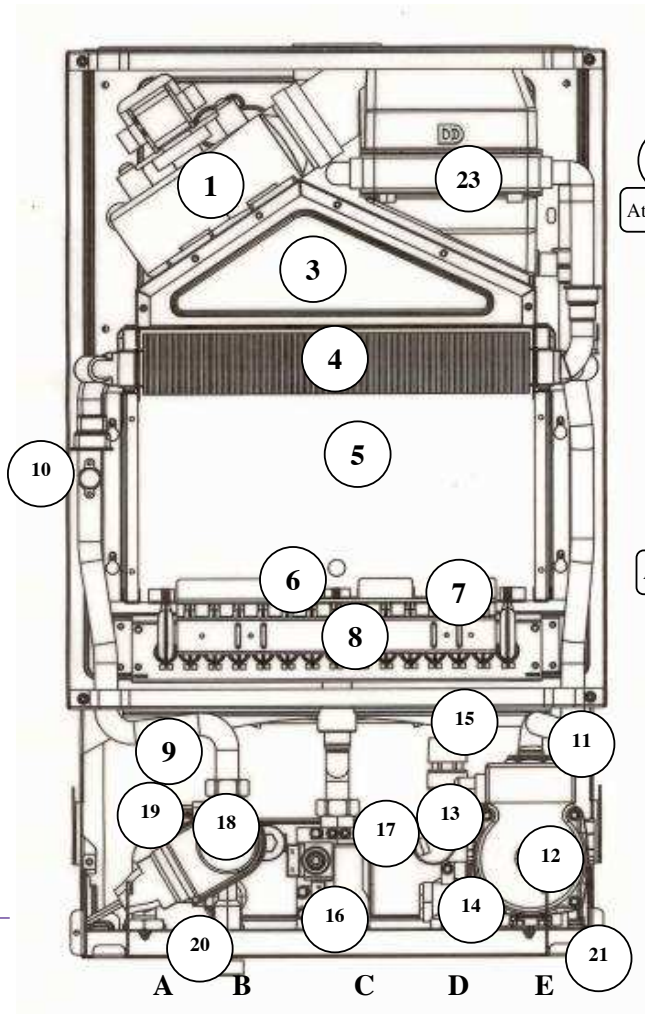

- 5 - Combustion Chamber
- 6 - Ignition Electrode
- 7 - Flame Sensor Electrode
- 8 - Burner
- 9 - Overheat Safety Thermostat
- 10 - Heating Sensor
- 11 - Automatic Air Vent
- 12 - Pump
- 13 - Water Pressure Switch/Sensor
- 14 - D.H.W. Flow Sensor
- 15 - Heating Circuit- Pressure Safety Valve
- 16 - Gas Valve
- 17 - Secondary Heat Exchanger
- 18 - Three-Port Valve Motor
- 19 - D.H.W. Sensor
- 20 - Three-Port Valve
- 21 - Filter Valve (Below the pump)
- 22 - Expansion Vessel (At rear of the boiler)
- 23 - Condensing Unit

- A - Heating Flow (22mm)
- B - D.H.W. Outlet (15mm)
- C - Gas Inlet (22mm)
- D - Cold Water Inlet (15mm)
- E - Heating Return (22mm)

Key

- 1 - Fan
- 2 - Air Pressure Switch
- 3 - Fan Hood
- 4 - Primary Heat Exchanger

3. Boiler Characteristics.

3.1 The Vizo24 / Vizo28 is a fan flued, wall-mounted condensing type combination boiler that supplies both central heating and mains fed domestic hot water. Being room sealed the boiler may be installed in any room or internal compartment without the need for purpose made ventilation. However, if the boiler is installed in a compartment it is recommended that the compartment is ventilated for cooling purposes. A functional diagram of the boiler's principal components is given as *figure 1*.

3.2 Range rated from 24kW to 28kW the Vizo24 / Vizo28 heat output can be focused to match the designed heating systems requirements by a simple adjustment.

3.3 An electronic control unit, consisting of a PCB, which includes ignition module provides direct burner ignition and flame supervision along with continuous modulation of the burner's gas supply.

3.4 An interface unit, which includes boiler adjustment potentiometers and fault display provides easy service ability to the boiler.

3.5 Heat transfer to the boiler's primary hydraulic circuit is obtained via a primary, gas to water heat exchanger contained within a hermetically sealed combustion chamber. A 230 volt, single speed fan expels the products of combustion from the combustion chamber to outside air via an associated flue system. The fan is activated at the beginning of each ignition cycle and its operation monitored by means of negative and positive sensing points connected to an air pressure switch.

3.6 A secondary heat exchanger allows the instantaneous transferral of heat from the primary hydraulic circuit to water destined for domestic hot water use. The secondary heat exchanger is sized so as to minimise thermal shock and is protected against the build up of lime scale by limiting the D.H.W. outlet water temperature to a maximum of 64°C.

3.7 An integral pump located in the boilers main hydraulic circuit circulates water through the primary heat exchanger to either the central heating circuit or D.H.W. heat exchanger, depending on the demand. In the event of reduced or interrupted water circulation in the central heating circuit, a system by-pass should be fitted as far away from the boiler as possible. Note: It is no longer permissible to utilise a non-thermostatic controlled radiator as a by-pass.

3.8 Room temperature can be controlled by the use of an external room thermostat or temperature regulator. Note connection of the room thermostat is dependant on the operating voltage of the thermostat. See section 9.4 & 9.5 for details

3.9 Using an outdoor temperature sensor, which can be connected directly to the main PCB, the boiler operating temperature can be automatically adjusted in line with outdoor climatic conditions.

3.10 The boiler incorporates an integrated clock, which allows the setting of central heating periods and the boiler's control panel incorporates an LCD display, which indicates the state of operation and fault defect codes.

4. Operation

- 4.1** Using the operating switch the boiler can be set to operate either on domestic hot water only or domestic hot water and heating.

Note: Domestic hot water demand draws preference over heating. During heating periods the boiler will automatically revert back to heating mode, after a draw off of hot water, but there will be a 45sec delay if the No.3 dipswitch is set to the OFF position. See fig 19 page 21.

- 4.2** Depending on demand water is either diverted via the three port valve to the secondary water-to-water heat exchanger for domestic hot water or directly to the heating system. Schematic diagrams showing the flow within the boiler's central heating hydraulic circuit **figure 2a** and D.H.W. hydraulic circuit **figure 2b** are given.

4.3 DOMESTIC HOT WATER MODE:

- On opening a hot water faucet the boiler automatically responds to fire the boiler and supply the water-to-water heat exchanger with hot water via the three port valve, located on the hydro-block. The boiler's electronic control unit automatically modulate the burner's output to maintain the required temperature at the faucet. Hot water will continue to flow until the faucet is closed and the boiler automatically shuts down. Note that the pump will continue to run for a further 10secs to dissipate the residual heat from the boiler.

4.4 DOMESTIC HOT WATER AND CENTRAL HEATING MODE:

- When heating demand is requested, power is on and the timer and thermostat are calling for heat, the boiler will fire automatically. An integral pump is then energised and hot water from the boiler's primary circuit is circulated around the central heating systems pipe-work and radiators. When the demand for central heating is no longer present, either the thermostat reaches temperature or the time clock reaches the end of its set period, the burner will shut down and the boiler will revert to stand-by, waiting to respond to the next heating or hot water demand. The pump will continue to operate for a short period of time to dissipate any excess heat from within the boiler's heat-exchanger. If during the heating period there

is a call for hot water this will take preference over heating. When satisfied the boiler will then supply the heating demand as required. Note there may be a 45sec delay depending on how the boiler's dipswitches are set. See section 15.4 for

details.

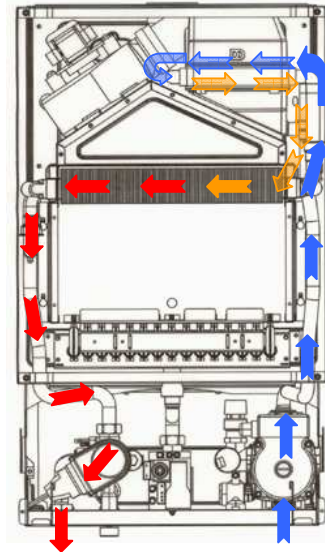

Figure 2a

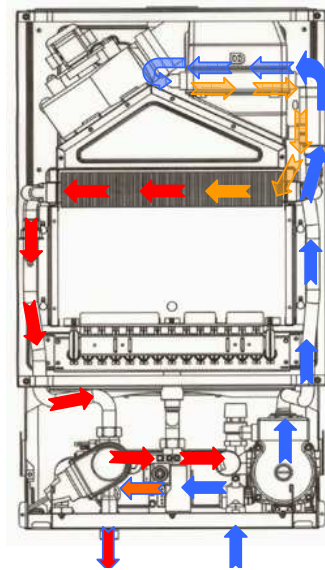

Figure 2b

5. General Installation

5.1 Installer Testing & Commissioning Tips

- The installer shall instruct the user in the operation of the boiler, safety devices contained within the boiler and instruction on how to re-pressurise the system if the water pressure falls. The installer should then hand over the instructions with the Benchmark Logbook that has been completed.
- The user should be instructed to keep the instructions in a safe place for servicing and future reference.
- It is important to keep the boiler clear of dust during the installation. In particular, do not allow debris to enter the top of the boiler where the flue connection is made. This may cause the fan outlet to get blocked or combustion chamber to fill with debris and will, of course, cause the boiler to fail to ignite on first ignition. It is recommended that you check the fan outlet before you light the boiler.
- Before you fit the boiler ensure that the pipe work that you are installing is connected to the appropriate connections on the boiler i.e. cold water pipe to cold water inlet, hot water outlet to the hot water tap etc.
- Because the boiler is actually operated, at the end of each production stage, a small amount of water is retained within the boiler when packed. Please ensure that you spin the pump rotor manually before firing the boiler.
- It is important that the boiler must be used in conjunction with a Heat Line approved flue and all flue connections are correctly sealed.
- Remember to flush out the system, both cold and hot, in order to remove the debris from the system. This should be done particularly where boilers are being fitted to existing radiator circuits.
- Refer to BS 7593:1992 for the details to clean DHW and Central heating system.
- **This boiler has been factory set and does not require any adjustments to the gas valve or fan speed.**
- Remember to release the small cap on top of the auto air purge device on the pump, 1 turn, before filling. This will ensure that air is removed as the system fills.
- **Do not use the pressure relief valve as a means of flushing the system.** please use the valve below the pump. Discharging water from the system from the pressure relief valve may allow water to seep after you have left the job, causing the boiler to lose pressure and debris to collect on the seating.
- The boiler is fitted with inlet filters both on the cold water inlet and the central heating return. If you are unable to obtain hot water at the faucet it is likely that the cold water inlet valve filter has become blocked, whilst blockage of the filter on

central heating return valve will cause the heater to lock out at the overheat thermostat as the water flow is reduced.

- If you are able to obtain hot water but not heating it is also advisable to check the clock connections and that the room thermostat and time clock are calling for heat.
- Remember that after hot water draw off there is a 45 sec delay before the heating will fire up if No.3 dipswitch is in the OFF position, see fig 19 on page 21
- When commissioning the boiler check the inlet pressure is at 20mbar and burner pressure against the Technical data on page 5.
- Note an anti-cycle delay time can be set up to a maximum of 255 seconds by adjusting potentiometer 2 as described in section 15.5 on page 21.

If you experience any problems please refer to the installation and commissioning guidelines within the boiler instruction manual. If necessary, please contact Heat Line™ Service Enquiries, in the UK, for further advice and assistance on **0870 777 8318**, in Ireland call **01 466 4664**.

**NOTE – FOR INSTALLERS:
REMEMBER IT IS A LEGAL REQUIREMENT
TO COMPLETE THE BENCHMARK CODE OF
PRACTICE LOGBOOK BEFORE LEAVING
THE INSTALLATION.**

5.2 The boiler is designed to operate on fully pumped, pressurised sealed systems operating at a maximum of 3bar pressure and maximum design flow temperature of 85°C.

5.3 The boiler's integral expansion vessel is pre-charged to a pressure of 0.5bar and will accommodate a system volume of 125 l. at an average water temperature of 75°C and maximum system pressure of 3 bar. If the system volume is more than 125 l. an additional expansion vessel must be fitted to suit the size of the system. A typical installation of an additional pressure vessel is shown below in *figure 3* below.

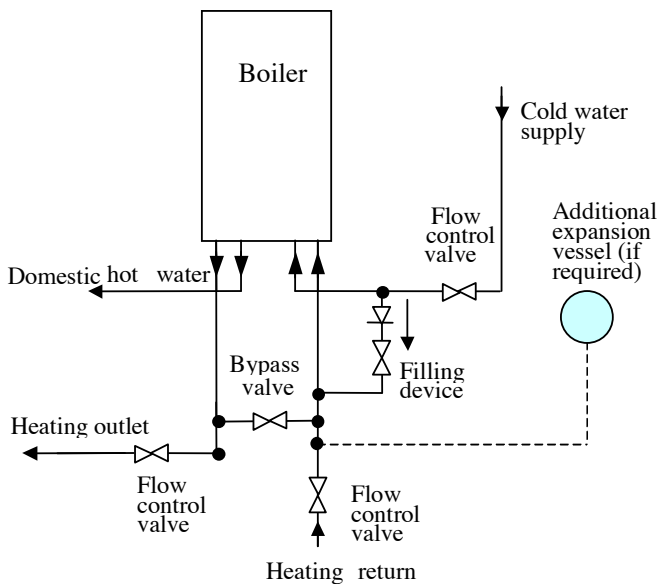

Figure 3.

5.4 The heating circuit should be designed and balanced to give a 20°C temperature rise across the boiler flow and return.

5.5 When fitting a new boiler to an existing system the system must be thoroughly flushed in accordance with the recommendations of BS7593 prior to installation.

5.6 It is recommended that the system should be protected by an anticorrosion inhibitor. Failure to comply with this requirement may invalidate your guarantee.

5.7 On installation it is important to ensure that the heat exchanger is not a natural collecting point for air and where possible, the system pipe work should have a gradient to ensure any excess air is carried naturally to other purpose made, air release points.

5.9 In high water volume systems or under floor heating systems where prolonged operation of the boiler is expected at temperatures below 60°C, a by-pass must be

installed on the boiler outlet in order to prevent condensation forming inside the combustion chamber. Failure to comply with this requirement will invalidate the manufacturer's guarantee.

5.10 The pressure relief discharge must be directed away from any electrical equipment or where it could cause a hazardous situation.

5.11 To enable adequate drainage of the system drain cocks compliant with BS2879 must be fitted at the lowest points in the system pipe-work.

5.12 To obtain the best hot water performance from your boiler it is suggested that the cold water supply to the boiler is the first draw off from the incoming mains supply. **Note** that the boiler will not operate unless there is a minimum pressure of 0.25bar with a flow rate of 2.5l/min. Where inlet pressures exceed 8bar, a pressure regulator must be fitted to the cold water supply.

5.13 Where cold water mains are fitted with a water meter, check valve(s) or loose jumper stopcock, a domestic hot water mini-expansion vessel may need to be fitted.

5.14 Although the boiler is designed to inhibit the formation of scale, in hard water areas above 200mg/l, a proprietary scale reduced should be fitted in the cold water supply to the boiler. Failure to comply may invalidate your guarantee.

5.15 To obtain the best hot water performance from your boiler it is suggested that supplies to faucets are run in 15mm copper, as short as possible and where practical, be insulated to reduce heat loss.

5.16 The boiler incorporates a frost protection thermostat. Therefore if the boiler will not be used for long periods of time during cold weather, in order to avoid freezing the electric supply must be left ON and all the central heating isolation valves must be left open. The internal frost thermostat will then operate the boiler if the temperature falls too low. However, if the electrical supply is to be turned off the boiler, the heating system and domestic hot water circuit must be drained.

6. Appliance Siting

6.1 If the boiler is to be installed in any room or compartment, it requires no purpose made ventilation for combustion air. If sited in a room containing a bath or shower then particular reference is drawn to the current I.E.E. Wiring Regulations and local Building Regulations.

6.2 If the Vizo24 / Vizo28 boiler is installed in a compartment there must be purpose made ventilation for cooling purposes.

6.3 The boiler is not suitable for external installation unless protected by a purpose made building such as a boiler house.

6.4 The following clearances are recommended for installation purposes; 200mm above, 300mm below and 50mm at each side. 600mm is required at the front but this may be upon opening a cupboard door.

6.5 The boiler must be sited at least 1m away from flammable materials and heat sensitive walls must be protected by appropriate insulation.

6.6 The wall on which the boiler is mounted must be sufficiently strong enough to support the weight of the boiler.

6.7 A condensate drain pipe must be fitted to allow discharge of condensate to a drain or soakway. Where possible condensate should be discharged into the household internal drainage system. If this is not practical, discharge can be made into an external drain. If neither of the above options are possible then condensate must be discharged into a purpose designed soakway.

- It is recommended that any external condensate pipe is insulated and increased to 32mm diameter in order to prevent the condensate from freezing.
- To avoid excessive condensation occurring within the boiler flue the boiler should wherever possible, be sited to ensure the shortest possible flue run is utilised.

6.8 For compartment installation the requirements of BS6798 and BS5440: Part 2 must be met.

- The compartment must be of sufficient size to permit access for inspection and servicing or the removal of the boiler and any ancillary equipment.
- Any space used for airing clothes or storage must be separated from the appliance by a non-combustible partition. Where the partition is formed from perforated material, then the major dimension of the apertures shall not exceed 13mm.
- No combustible surface must be within 20mm of the boiler casing without protection.
- There must be 20mm clearance between the compartment door and boiler case.

- Where the boiler's flue pipe passes through the airing space, it must be protected by a non-combustible sleeve or fire stop which has a minimum clearance of 20 mm from the flue pipe. In addition, if the flue pipe passes through the partition then the clearance gap of the flue pipe or its guard with the partition must not exceed 13 mm.

6.9 When the boiler is intended for use with LPG it must not be installed in a room or internal space below ground level..

7. Flue Terminal Location

7.1 The flue terminal must be sited with minimum clearances as specified in **Figure 4**. Note if plumbing becomes problematic or causes a nuisance a plume management kit is available from your stockist.

7.2 Current regulations and standards require a terminal guard to be fitted where the terminal is accessible to touch or at risk of being damaged. All wall mounted terminals sited within 2m of the level which people have normal access, should be adequately protected with a suitably sited guard

7.3 Where the flue terminates within 1m of a plastic or painted gutter or within 500mm of painted eaves then protection should be provided in the form of an aluminium shield at least 1m in length, fitted to the underside of the gutter or painted surface.

7.4 The flue should not be sited where the condensate "plume" may give rise to a nuisance factor under certain weather conditions.

NOTE: If you have difficulty siting the flue in an appropriate location your supplier will be happy to supply a "anti-plume management kit", which discharges the flue products at a higher level.

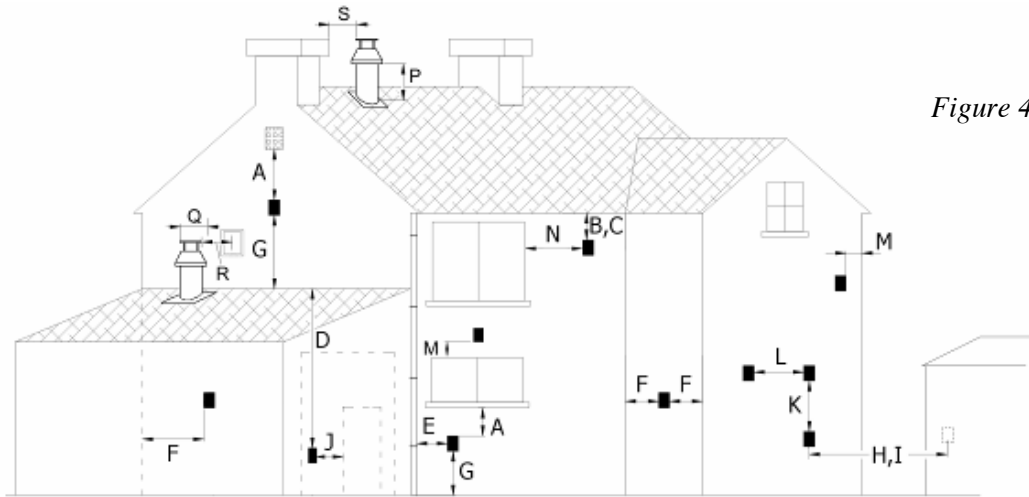
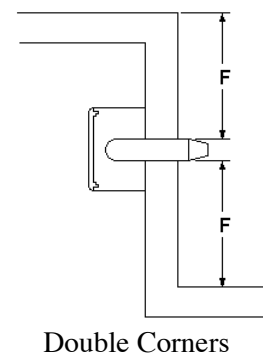
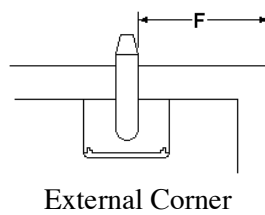
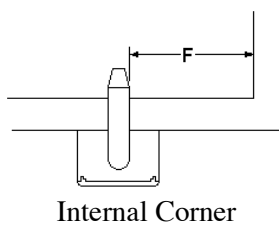

Figure 4

TERMINAL POSITION	MINIMUM DISTANCE
A- Directly below an openable window or other opening e.g. air brick	300 mm
B- Below gutters, soil pipes or drain pipes	75 mm
C- Below eaves	200 mm
D- Below balconies or car front roofs	200 mm
E- From vertical drain pipes and soil pipes	150 mm
F- From internal or external corners	300 mm
G- Above ground, roof or balcony level	300 mm
H- From a surface facing a terminal	600 mm
I- From a terminal discharging towards another terminal	1200 mm
J- From an opening in a car port (e.g. door, window) into a dwelling	1200 mm
K- Vertically from a terminal on the same wall	1500 mm
L- Horizontally from a terminal on the same wall	300 mm
M- Above an opening, air brick, opening windows, etc.	300 mm
N- Horizontally to an opening, air brick, opening windows, etc.	300 mm
P- Above roof level (to base of terminal)	300 mm
Q- From adjacent wall to flue	300 mm
R- From an adjacent opening window	1000 mm
S- From another roof terminal	600 mm



8. General Flue Info

8.1 The boiler utilises a concentric flue arrangement which consists of a 60mm-diameter inner flue and 100mm-diameter outer air inlet duct.

8.2 A standard 700+/-5mm flue kit (*figure 5*) is supplied with the boiler, which can be routed to the rear, left or right of the appliance by means of a 90° degree bend. The bend is connected to the boiler using the screws provided and sealed with the gasket.

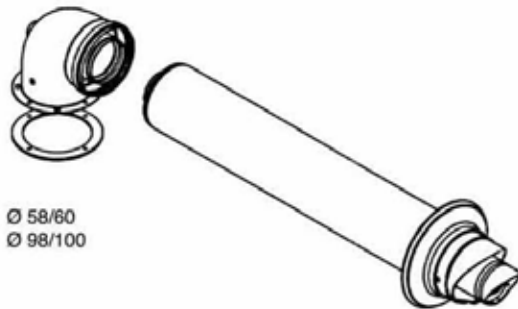

Fig.5

8.3. The 60/100cm flue pipes may be extended up to a maximum of 2.5m using additional spare components available from your supplier. This length can be increased to 7m using the 80/125mm flue kit.

8.4. A vertical 60/100cm flue kit is also available from your supplier up to a maximum length of 3m. The terminal is suitable for a flat or pitched roof. This length can be increased to 8m using the 80/125mm flue kit.

8.5. The flue restrictor, as shown in *figure 6*, supplied with this boiler is NOT required.



Figure 6a

8.6. The connection of vertical flue system is similar to the Horizontal flue connection. The flue is connected to the boiler via connection screws whilst the sections are held together with the clamps provided.

8.7. To avoid condensate dripping from the terminal the flue should be installed with an upward gradient (from the boiler) of 3°.

Note. For each additional 90° elbow used the maximum flue length must be reduced by 1.5 m, whilst the use of 2 x 45° bends warrants a reduction of 2m.

WARNING!

ONLY A HEATLINE APPROVED FLUE IS TO BE USED WITH THIS PRODUCT. FAILURE TO COMPLY WITH THIS REQUIREMENT WILL INVALIDATE YOUR GUARANTEE AND COULD LEAD TO PROSECUTION.

9. Electrical Connections

9.1 The boiler is supplied factory wired complete with 1.5 m of mains fly lead. All electrical connections to the mains supply must be made in full accordance with the current I.E.E. regulations.

9.2 The boiler must be connected to an effective earth system. Using the cable supplied the boiler may be connected via a 3 amp fused three pin plug to an unswitched shuttered socket outlet. However if the boiler is installed in a room containing a bath or shower regulations dictate that disconnection must be incorporated in the fixed wiring with a switch provided for disconnection from the mains supply having a contact separation of at least 3 mm on all poles and fused at 3 amp.

9.3 The point of connection must be readily accessible, at a distance no further than 1.5m adjacent to the appliance and provide complete electrical isolation for the boiler and control system.

9.4 The low voltage room thermostat terminal block is located to behind of left side of the plastic cover (*figure 7*). On connection of a voltage free room thermostat to the boiler, the factory fitted bridge across the room thermostat terminal connectors must be removed. If a mains voltage thermostat is to be used the please refer to *figure 8*.

9.5 Mains powered thermostats must be connected directly to the mains circuit board as indicated in *Figure 8*. Cut the existing link and connect the wires into the thermostat circuit.

9.6 Ensure that the polarity of the mains connection is correct as reversed polarity may cause the appliance to malfunction.

9.7 While the boiler's main pcb, pump, three-way valve and gas valve are supplied at 230V AC., all other components and associated circuits are supplied at low voltage.

9.8 On connecting the mains electrical supply to the boiler, it is essential to ensure that electrical safety checks for earth continuity, earth resistance, polarity and short circuit are carried out prior to making the

final connection. A diagram of the boiler's electrical circuit is given as *figure 9*.



Figure 8

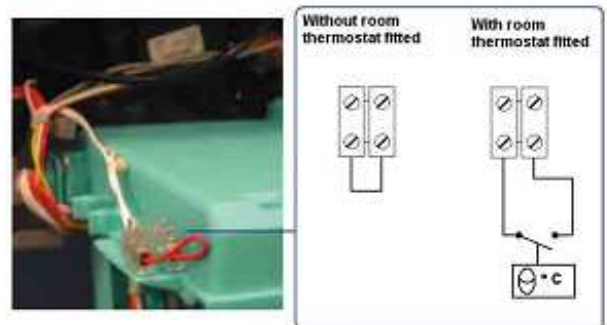

Figure 7

9.9 Fuse Ratings

Bertelli & Partners Circuit Board

F1 – 3.15amp fast blow

F2 – 2amp fast blow

SIT Circuit Board

F1 – 2amp fast blow

F2 – 2amp fast blow

Warning: On no account must any external voltage be applied to any of the terminals on the heating control connection plug.

Important Note.

Connection to the mains electrical supply must be maintained at all times in order to provide domestic hot water, frost protection and pump over-run facility. Ensure that the boilers electrical supply is not interrupted by any external controls.

10. Boiler Installation

10.1 Prior to installing the boiler check the contents of the carton: Appliance, Valves (Fixing Jig Optional), Wall Hanging Bracket, Mounting Template Service, Installation and User Manual, Guarantee Card and Benchmark Log Book. The boiler dimensions are given in *figure 10*.

10.2 Ensure that the boiler is suitable for the gas supply by checking the data plate, which is situated on the inside of the control panel door, and that the system and chosen boiler position is in accordance to Sections 5, 6 and 7 of these instructions.

Dimension	Vizo24	Vizo28
A	405	430
B	169	169
C	60/100	60/100
F	39	64
G	64	64

Figure 10

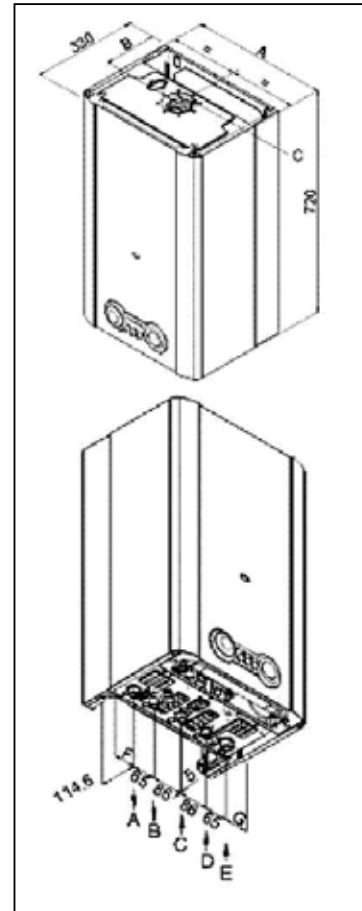

TOP

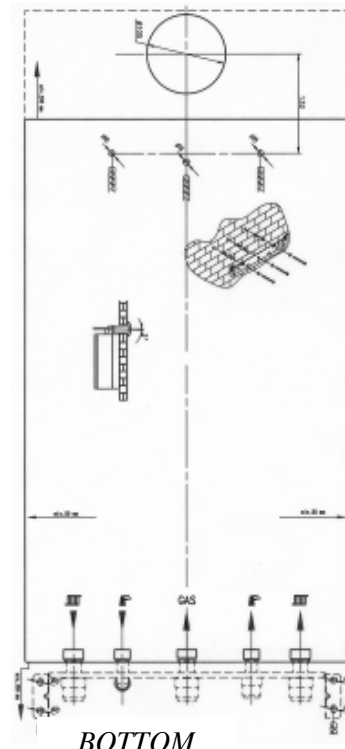
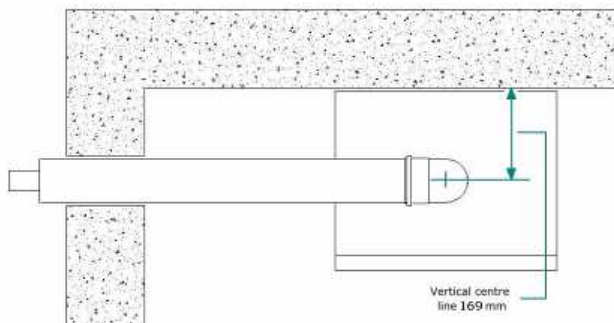

Figure 11

10.3 Position the supplied template on the wall, ensuring it is level both vertically and horizontally (*figure 11*). Mark the boiler fixing jig (if required), wall bracket fixing positions and flue outlet position (rear flue only). For flue side exit from the boiler - Mark the horizontal flue centre line on the rear wall. Extend the horizontal line to the side wall allowing a 3° decline back towards the boiler, to enable condensate to drain back through the boiler. Mark the flue centre vertical line. (*figure 12*.)

Figure 12.



10.4 When cutting the flue hole it is recommended that a 105mm diameter core drill is used where both internal and external access for the flue installation is available. Where only internal access is available a 125mm diameter core drill should be used. (Note: Please take adequate precautions to prevent debris entering the boiler via the flue outlet).

10.5 Using a 8.5mm drill bit, drill the holes for fixing jig (optional) and hanging bracket. Locate and secure the supplied wall mounting bracket and fixing jig in position (*figure 13*).

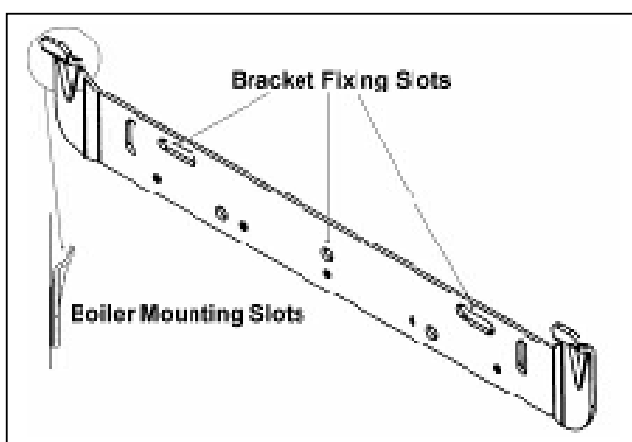

10.6 Mount the boiler *figure 13* bracket via the boiler mounting slots, (*figure 13*).

10.7 Connect isolation valves assembled (on the fixing jig, if used) to the boiler ensuring the washers are fitted correctly.

10.8 On installing the flue, determine the required length of the **outer air duct** by measuring the distance 'L' (*figure 14b*) from the face of the external wall to the back of boiler's elbow connecting collar. The measurement for the **inner flue duct** will be 'L' + 20mm

10.9 Measuring from the back of the terminal connection, mark distance 'L' onto the outer air duct. (*figure 14a*)

10.10 Cut the **outer air duct only** to the required length ensuring that the cut is square and free from burrs.

figure 14a

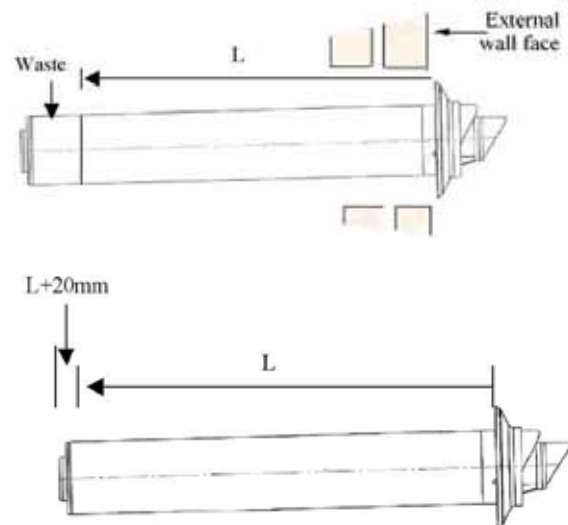

figure 14b

10.11 Measuring from the back of the terminal connection, mark distance 'L' + 20mm (*figure 14*) onto the inner flue duct and cut the duct to size, ensuring that the cut is square and free from burrs.

10.12 Pass the flue assembly through the wall and connect the assembly to the boiler, ensuring that both the air and flue duct joints are fully pushed home into the connecting elbow's collar.

10.13 With the flue and joints secured fit the flue trim to the external wall surface using a suitable mastic. **Note.** Where internal access only is available, the flue trim must be attached to the flue assembly prior to passing the assembly through the wall.

10.14 For maximum flue lengths refer to the Technical Data on page 5 in this manual

10.15 Condensing type boilers must be connected to the drainage system. A plastic drain must be fitted to allow discharge of condensate to a drain.

Condensate should, if possible, be discharged into the internal household draining system. If this is not practical, discharge can be made externally into the household drainage system or a purpose designed soak away. Note if a soakway is used the drain must terminate at least 500mm from the external wall.

10.16 Extract the bottom part of condensate trap , by turning anti-clockwise and fill it with approximately 50 cc water re-connecting it to the boiler. (*Figure b*).

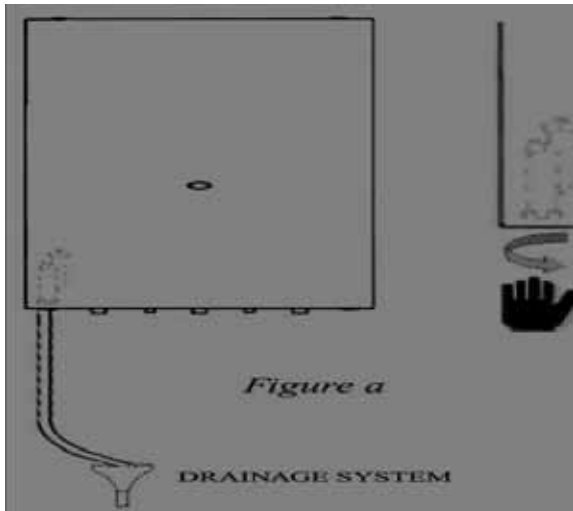

10.17 Connect the condensate drainage pipe to the drainage system. (*Figure a*) Note due to the acidic nature of the condensate the drainage system must be made of non-corrosive material such as plastic tubing.

10.18 Connect the domestic hot water, cold water inlet, heating system flow & return and pressure relief valve pipework to the boiler fittings, ensuring that the pipework has been correctly flushed before final connection.

10.19 The electrical connections to the boiler must be in accordance to Section 9 of these instructions.

NOTE: Place the filling loop in a visible accessible position and instruct the user how to pressurise the system if there is a fall in pressure.

11. Gas Supply

11.1 The gas supply pipe must be capable of supplying the quantity of gas required by the boiler (see Technical Data, section 2, page 5) in addition to the demand of any other gas appliances being serviced from that supply.

11.2 The internal diameter of the gas supply from the meter to the boiler's gas inlet connection must not be less than 22mm.

11.3 The meter governor must be capable of delivering a pressure of 20mbar (for natural gas).

11.4 On final connection of the gas supply to the boiler, the complete gas installation including the gas meter, must be tested for soundness and purged.

12. Filling the System

12.1 The boiler must not be operated without water.

12.2 On completion of the boiler installation and ensuring that all water connections are correctly made the boiler may be filled with water via the filling loop (not supplied with the boiler). Ensure that two manual feed valves and boiler isolation valves are open.

12.3 Release the cover cap of the boiler's automatic air vent situated on top of the pump. (*Figure 15*)

12.4 The manual feed valves must be closed and the filling loop disconnected once the pressure sensor, sited on the boiler's control panel, indicates a system pressure between 1.0 and 1.5 bar.

Figure 15

Release cover cap when filling system



12.5 Check that all the water connections throughout the system are sound and bleed each of the heating system's radiators in turn. As air is vented the system pressure may need topping back up to 1.0bar.

12.6 Air must be vented from the boiler's pump by unscrewing the pump's integral vent plug and allowing water to bleed for a few seconds. Take care not to allow water to splash onto any electrical components.

12.7 When the system is bled of any air it must be re-filled until the pressure shown on the display gauge indicates a system pressure of 1.5bar.

12.8 If the pressure exceeds 1.5 bar discharge the excess pressure from the system via a radiator valve or pipe connection.

Do not use the safety discharge valve as the valve seat may become contaminated with debris and fail to re-seal.

Important Note.

In order to maintain the appliance's warranty; after initial filling the heating system must be thoroughly flushed using a propriety cleanser to remove foreign material and contaminants.

13. Control Panel Functions

- | | |
|----------------------------------|--------------------|
| 1- D.H.W. temperature control | 4- Function switch |
| 2- C/heating temperature control | 5- Timer |
| 3- System pressure gauge | 6- LED Display |

13.1 C/heating and D.H.W. temperature controls: The boiler's integral control unit monitors and adjusts both the boiler's hydraulic circuit and D.H.W. water outlet temperatures by means of sensors located on the C/heating and D.H.W. flow outlets. The sensors electrical resistance, which is dependant on temperature, determines the current passing through the control potentiometers located on the control panel. The respective potentiometer control dial allows manual setting of the maximum required temperature (reference value) being between 30° and 85°C for C/heating and 35° and 64°C for D.H.W. When the boiler operates in heating or D.H.W. mode, the current received is compared to the manually set reference value. The difference of the two values operates the modulation of the gas valve adjusting the useful heat output generated and stabilising the temperature to within $\pm 1^{\circ}\text{C}$.

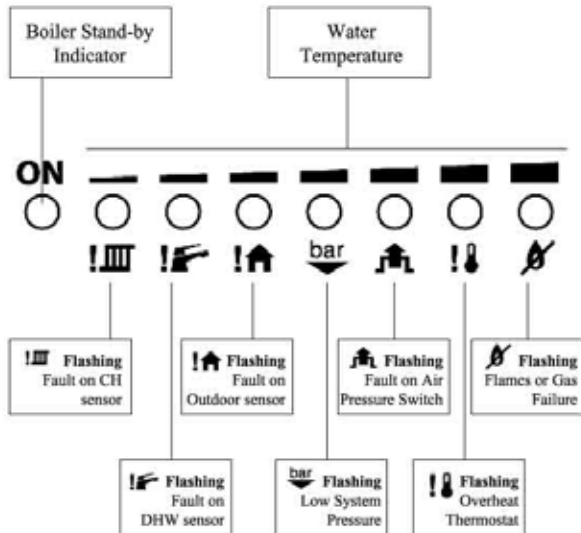

Figure 17

13.2 Re-set function: Should the boiler lock out at any time, please check the gas supply and ionisation probe position, the boiler may be re-started by switching to standby “O” position (*Switch 4 figure 16*) waiting 15-30 seconds and switching back to its previous position once the fault has been eliminated.

13.3 Function switch: The three position switch allows the boilers operation to be set to 'Stand-by' (centre position), 'Heating + D.H.W.' (left hand position) or 'D.H.W. only' (right hand position)

14. Commissioning

14.1 The Vizo 24 & 28 boilers have been tested and pre-set at the factory and is dispatched with its on board controls set to provide a maximum central heating and D.H.W. output. Consequently, once all the connections have been made and the boiler has been filled with water to the designed system operating pressure, the boiler may be fired prior to adjusting it's on board parameters to match the heating systems requirements.

14.2 Prior to firing, check that the electrical supply to the boiler is 'On' (The green boiler 'Stand by' indicator will light) and the gas service cock is in the open position.

- Set the boiler's central heating and domestic hot water temperature controls to maximum by turning them fully clockwise.
- Set the external room thermostat (if fitted) to maximum and open the thermostatic radiator valves to maximum.

14.3 Switch the boilers function switch to the central heating and domestic hot water position. The boiler's control unit will now automatically carry out pre-ignition safety checks before igniting the burner.

14.4 During the 10 second burner ignition attempt visually check that all of the burner blades ignite correctly.

If necessary, adjustments to the ignition rate may be made using potentiometer P4. Turning P4 **clockwise increases** the ignition rate and **anti-clockwise decreases** the rate. After successful ignition check the integrity of the boiler's flue for soundness and correct operation.

14.5 Check the boiler for correct domestic hot water operation by opening and closing the household domestic hot water draw off taps.

14.6 In order to maintain the appliance warranty after initial filling the heating system must be thoroughly flushed using a propriety cleanser to remove foreign material and contaminants.

14.7 Restart the boiler and again allow the central heating system to reach maximum operating temperature. Check that all the water connections throughout the system are sound and bleed each of the heating systems radiators and purpose made air release points in turn.

14.8 Check the system pressure and top up if necessary.

14.9 Reset the central heating & domestic hot water temperature controls and room thermostat to the desired temperature settings.

Important Notice.

- Failure to thoroughly power flush the boiler and heating system or to add an anti corrosion inhibitor to the system water will invalidate the boiler's warranty.
- The condensate trap must be filled with water and plastic discharge pipe connected to drain before operating the boiler.

15. Onboard Adjustments

15.1 The boiler incorporates 4 potentiometers and a bank of dip switches to allow adjustment to its pre-set parameters. These are situated on the rear of the control panel. (*figure 18*)

The potentiometers can easily be accessed by removing the cover on the rear of control panel (*Figure 19*). However, to reach the dip switches, the control panel must be opened.

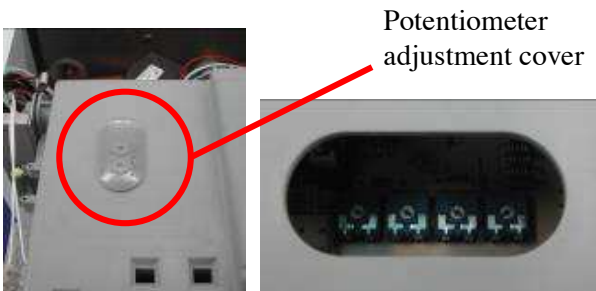

Figure 18

21

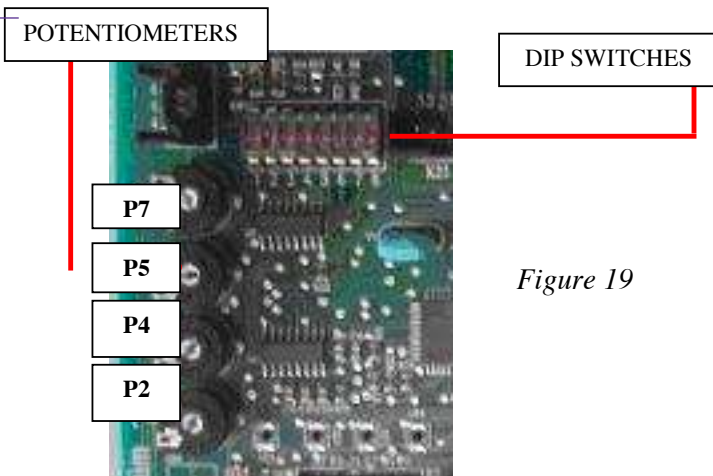
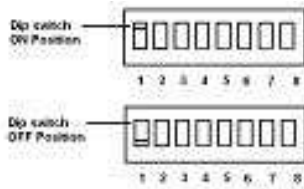

Figure 19



maximum flow temperature factory set to 90°C. Where a lower maximum temperature is required such as in the case of under-floor heating, the factory setting can be altered between a maximum of 50°C and a minimum of 30°C, by fitting dip switch '6' into ON position.

15.3 Setting the boiler's integral pump: The boiler's integral pump is factory set to operate in both central heating and D.H.W. mode. Where an external pump is incorporated into the system design the integral pump may be disconnected in central heating mode by fitting dip switch '5' into the ON position.

15.4 Setting the 45 seconds delay: The boiler is factory set to exclude the delay of 45 seconds before re-ignition between the closing of a hot water tap and CH start-up. This delay can be set to 45 seconds by setting dip switch '3' (*figure 19*) into the OFF position.

15.5 255 seconds delay setting: The boiler is capable of up to 255 seconds ignition delay (anti cycling time) before re-ignition following burner shut down on the primary hydraulic water reaching its set temperature. This delay can be increased up to a maximum of 255 seconds by turning potentiometer P5 (*Figure 19*) clockwise.

15.6 Pump working mode setting: The boiler is factory set to operate the pump for a period of 45sec before and after a heating cycle. This delay can be cancelled by setting dipswitch '2' (*figure 19*) to the ON position. However, this is not recommended as the boiler over-heat thermostat may trip out, causing lock-out of the boiler.

15.7 Setting the Heating output: The Vizo 24 & 28 boilers are factory set to give maximum c/heating output. The maximum and minimum heat output for heating and domestic hot water may be adjusted, if required, using potentiometers P2 & P4 (*figure 19*).

15.2 Setting the maximum c/heating flow temperature: The boiler is dispatched with a

15.8 Gas valve ignition capacity. The graduated opening of the gas valve for ignition rate is governed by the 1st potentiometer P7 control, which is factory set. To assist in setting the boiler's modulating gas rate parameters the ignition rate of the valve can be forced from minimum to maximum rate by setting the potentiometer clockwise.

Important.

Gas Type Dip Switch Positioning, Dip Switch 1, Dip Switch 4 and Dip Switch 5 is factory set and must not be adjusted.

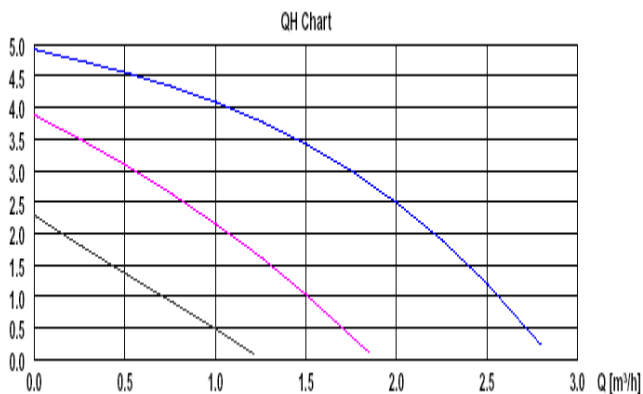

Figure 20

15.9 The boiler's integral pump is factory set to its maximum speed setting to give a 1000 l/hr flow on a nominal 4m head. The pump may be adjusted to a lower speed to match the designed c/heating system requirements. (figure 20)

off if the pressure is below 0.3bar. The boiler will not operate until the circuit has been re-pressurised.

16.2 The temperature of the water flowing from the primary heat exchanger is monitored by an overheat thermostat located on the outlet pipe. If the water temperature gets too hot the switch opens, cutting off the electrical supply to the gas valve and causing the boiler to 'Lock-out'. Once activated the boiler has to be manually re-set by switching the control knob off (for 15 seconds) and on again.

16.3 For HK type; an air pressure switch situated in the boiler's fan compartment monitors the boiler's flue operation. If a partial obstruction within the flue occurs the fan will continue operating but the boiler's burner will shut down until the blockage is cleared.

16.4 The boiler's control unit has in-built frost protection device that fires the boiler's burner when the temperature of primary hydraulic water falls below 6°C. The device works irrespective of any room thermostat setting and will protect the complete heating system. On reaching a water temperature of 15°C the boiler reverts back to normal operation.

16.5 If there is a fault on DHW sensor, system continues operation by controlling DHW outlet temperature by flow sensor and CH sensor, which limits the temperature up to 65°C during DHW operation. If such failure occurs and displays on LED screen, please contact service department.

16. Safety Devices

16.1 A hydraulically operated primary pressure sensor monitors water pressure or water shortage in the primary hydraulic circuit and will switch the boiler

17. Routine Servicing

17.1 To ensure the continued efficient and safe operation of the boiler it is recommended that it is checked and serviced regularly. The servicing must be carried out by a competent person in accordance with the Gas Safety (Installation and Use) Regulations. The frequency of servicing will depend upon the particular installation conditions and usage, but in all cases the boiler must be serviced at least once a year.

17.2 Following servicing of the boiler the relevant sections of the 'Benchmark' Installation, Commissioning and Servicing Log Book must be completed.

17.3 Prior to servicing a check of the flue operation and terminal guard (if fitted) along with a preliminary check of the boilers operation must be undertaken.

17.4 Ensure the boiler is cold and that both the electrical and gas supplies to the boiler are isolated before commencing service of the boiler.



Figure 21

17.5 Remove the boiler casing as follows:

- Open the front panel by removing two screws at the bottom of the boiler, *figure 21*.
- Release the hermetic chamber cover by removing two screws on both sides and by lifting them to release from their retaining hooks. (*figure 22*)
- Release the side panels by removing the screws on the upper and lower sides (*figure 22a*). Remove the panels by swinging them out and lifting them up



17.5 Remove the combustion chamber cover by removing four screws on sides. (*figure 23*)



17.6 Disconnect the electrical leads and air pressure switch connection tube from the fan, remove the fan screws and withdraw fan from fan hood with its 56° bend. (**Figure 24**)

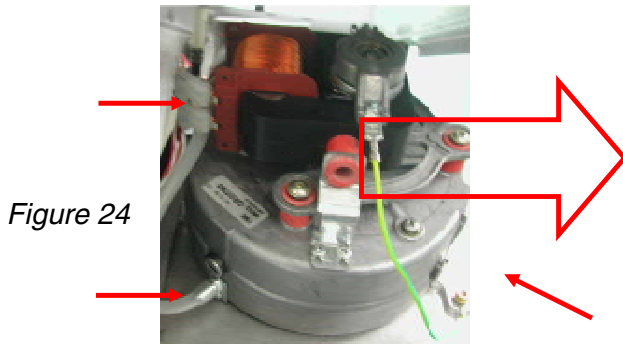
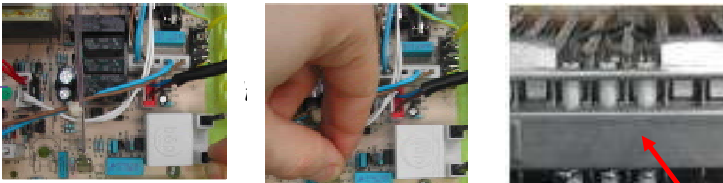

Figure 24

17.7 Remove the burner assembly from the combustion chamber as follows:

- ❑ Pull off the ignition and flame electrode leads from the PCB and remove the wires with grommet from the combustion chamber base. (**Figure 25**)

Figure 25



- ❑ Remove the burner-retaining screws at the sides and remove the burner.



Ionisation electrode

Ignition electrodes

Figure 26

Note. All washers/gaskets must be retained for use on re-assembly, replace if damaged.

17.8 Visually check for debris/damage and clean/replace as necessary the following items:

- ⇒ Heat exchanger
- ⇒ Burner
- ⇒ Fan/compartment for HK type
- ⇒ Electrodes

⇒ Insulation/gaskets

Important.

- ❖ Clean the heat exchanger using a soft brush or vacuum cleaner. **Do not** use any tool likely to damage painted finish of heat exchanger.
- ❖ Clean the burner by washing in soapy water. Allow to dry thoroughly before re-fitting.
- ❖ **Do not** use wire or a sharp instrument to clean the burner injectors.
- ❖ Ensure the ignition electrode gap is set to **4 mm**.

17.9 The boiler is fitted with a cold water inlet filter which must be inspected on each service. To access the filter:

- ❑ Close the isolating valve on the boiler's cold water domestic inlet by turning the valve head fully clockwise.
- ❑ Open one or more hot water taps to drain the domestic hot water circuit.
- ❑ Disconnect the cold water inlet connection to the boiler.
- ❑ Clean and inspect the filter, replace if necessary as described in (**18.20**).
- ❑ Re-fit the filter and reinstate the cold water inlet connection to the boiler, fit new gasket as required.
- ❑ Fully open the isolating valve on boiler's cold water inlet and check for leaks.

17.10 Cleaning the Condensate trap. Extract the bottom part of condensate trap, by turning anti-clockwise. Clean the trap using a household proprietary cleanser, preferably containing bleach.

17.11 On completing the service reassemble the boiler components in reverse order of removal, ensuring that all component joints and gaskets are sound. Any damaged seal or gasket must be replaced.

17.12 Reinstall the boiler's electrical and gas supplies and check for gas soundness and correct boiler operation.

18. Component Replacement

CAUTION!

While there are no substances harmful to health contained within this appliance, some component parts of the boiler (insulation pads, gaskets and rope seals) are manufactured from man made fibres. When damaged or broken these fibres may cause a temporary irritation. High dust levels may irritate eyes and upper respiratory system. It is important therefore, that sensible precautions are applied when exchanging components.

18.1 Ensure that both the electrical and gas supplies to the boiler are isolated before replacing any component part.

18.2 To prevent the need to drain the entire heating system when replacing the boiler's integral pump, expansion vessel, safety relief valve and pressure sensor, the boiler's hydraulic circuit may be isolated from the central heating circuit by closing the boilers isolation valves. Opening the discharge valve will then drain the boiler's hydraulic circuit. Note clean the valve seat to ensure it seals before re-filling the boiler.

18.3 For replacement of the following components it will be necessary to remove the boiler casing panels as described in Section 17.

18.4 Domestic hot water sensor

- The domestic hot water sensor is located on the left side of the hydraulic block's hot water side. (*figure 27*)



Figure 27

- Isolate the cold mains inlet, located at the cold water inlet shown in *figure 2b* on page 8 and open the hot water faucets to drain the system.
- Carefully disconnect the leads from the sensor.
- Remove the sensor using a 13mm spanner.
- Fit the replacement sensor ensuring the washer is correctly fitted, close the water faucets and open the mains water inlet to the boiler.
- Re-fit the leads to the replacement sensor

18.5 Central heating sensor

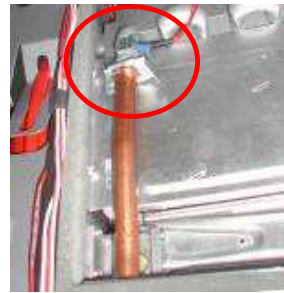

- The c/heating sensor is located on left side of the combustion chamber on the outlet of the primary heat exchanger. (*Figure 28*)
- Unclip the sensor from the pipe.
- Disconnect the leads from the sensor.
- Fit replacement sensor.
- Fit the leads and replacement the sensor

18.6 Fan Unit

- Disconnect the electrical leads from the fan.
- To remove the fan, disconnect the 90° bend from the top of the boiler
- Disconnect the electrical leads and air pressure switch connection tube from the fan, remove the fan screws and withdraw fan from fan hood with its 56° bend. (*Figure 24*)
- Fit the replacement fan unit in reverse order and reconnect the electrical leads and sensing tube.

WARNING! Ensure that the earth lead is re-connected.

18.7 Air pressure switch

- The air pressure switch is located on the top of the expansion vessel. (*figure 29*)
- Remove the sensing tube and electrical connections from the air pressure switch, noting which tube is connected to which port.
- Remove the air pressure switch by pulling forward off its bracket.
- Fit the replacement switch in reverse order of removal.

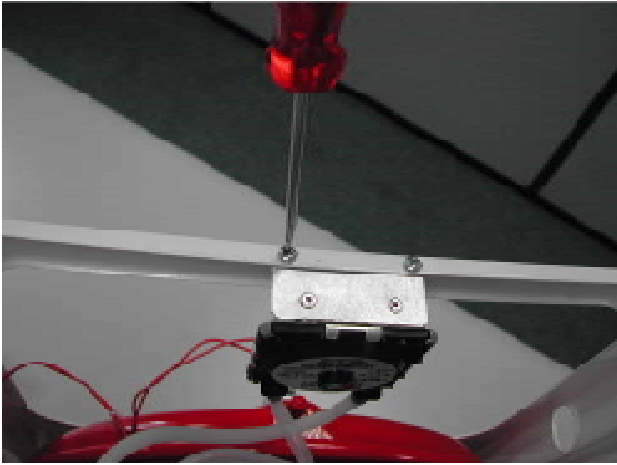

Figure 29 Air pressure switch

18.8 Burner

Note. The replacement burner is supplied as component parts and requires assembly on site.

- ❑ Remove the burner assembly from the combustion chamber as detailed in **Section 17.7** retaining all washers/gaskets for use on re-assembly.
- ❑ Remove the burner injectors as shown in *figure 30*.
- ❑ Fit the burner injectors to the new burner injector bar and tighten, ensuring that the injector size, marked on each injector is the same as stated in the **'Technical Data'** section for the type of gas being used.



Figure 30

- ❑ Replace the burner bar and re-fit the burner blades (replace any damaged seals as necessary) and reassemble the boiler in reverse order.
- ❑ Check gas soundness and boiler operation. **18.9 Printed circuit board (PCB)**
- ❑ Turn off and isolate the electrical supply.
- ❑ Remove the interface cover by lifting the two latches. (*figure 31*)

- ❑ Remove the electrical connections to the PCB by pulling carefully, noting the locations of all the terminals.
- ❑ Release the screws securing the PCB to the control panel and lift out the PCB.
- ❑ Fit the replacement PCB in reverse order to removal, ensuring that the PCB electrical connections are fully pushed home.
- ❑ Check and re-set as necessary the potentiometers and dip switches to the same value as the old PCB.



Figure 31

Figure 32

18.10 Pump

- ❑ Follow 18.10a or b depending on type of failure.

18.10a Replacing motor:

- ❑ Drain the boiler's hydraulic circuit as detailed in **(18.2)**.
- ❑ Remove the screws shown in *figure 33*.



Figure 33

- ❑ Pull off the motor, remove the cover and disconnect the electrical leads from cable box *figure 34*.



Figure 34

- ❑ Fit the replacement motor in reverse order ensuring correct polarity of the electrical connections.
- ❑ Re-open the isolating valves on the flow and return connections, refill, vent and re-pressurise the system and check for leakage.

18.10b Replacing the pump body:

- ❑ Remove the motor as described above.
- ❑ Remove the secondary water-to-water heat exchanger as detailed in (18.12).
- ❑ Remove the expansion vessel pipe by removing the clip on the pump body.
- ❑ Remove the pressure gauge connection for HK B 1xx type as detailed in (18.11).
- ❑ Disconnect the electrical leads of low pressure sensor.
- ❑ Disconnect the pumps outlet fitting. (Figure 35)



Figure 35

- ❑ Remove the fixing screws from the pump and hydraulic block at the bottom of the boiler (Figure 36).



Figure 36

- ❑ Remove the pump assembly.
- ❑ Remove the pump body from the hydraulic assembly by releasing the clip.

- ❑ Fit the replacement body in reverse order ensuring that the pump washers are sound and fitted correctly and the polarity of the electrical connections are correct.
- ❑ Open the isolating valves on the low and return connections, refill, vent and re-pressurise the system ensuring all joints are sound.

18.11 Low water pressure sensor

- ❑ Drain the boiler's hydraulic circuit as detailed in (18.2).
- ❑ Locate the system pressure sensor at the front right handside of the boiler and remove the electrical sensors connections. (figure 37)

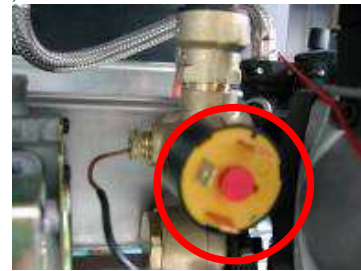

Figure 37

- ❑ Remove the pressure sensor by turning it in an anticlockwise direction.
- ❑ Fit the replacement sensor in reverse order of removal ensuring all washers are fitted. Replace damaged washers as necessary.
- ❑ Open the isolating valves on the flow and return connections, refill, vent and re-pressurise the system ensuring all joints are sound.

18.12 Secondary Heat Exchanger

- ❑ Drain the boiler's hydraulic circuit as detailed in (18.2)
- ❑ Remove the two screws which connect the heat exchanger to hydraulic circuit. (Figure 38)

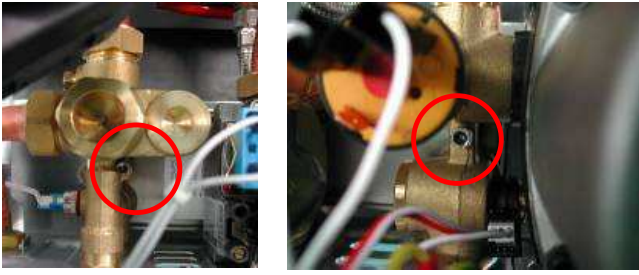

Figure 38

- Remove the exchanger from the gap on the left hand side.



Figure 39

- Fit the new heat exchanger checking that the plate numbers are the same and reassemble the boiler in reverse order ensuring all washers are fitted or replaced as required.
- Open the isolating valves on the flow and return connections, refill, vent and re-pressurise the system ensuring all joints are sound.

18.13 Primary Heat Exchanger

- Drain the boiler's hydraulic circuit as detailed in (18.2)
- Remove the pipe clips on the pipes of heat exchanger.
- Release the union connections on the connection pipes, retaining the washers for re-assembly.
- Remove the CH temperature sensor on the return pipe.
- Remove the pump-heat exchanger and heat exchanger-three way valve connection pipes.

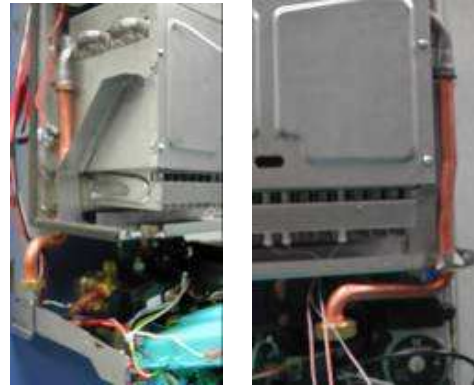

Figure 40

- Remove the combustion chamber cover.
- Remove the heat exchanger by pulling forward.
- Fit the new heat exchanger and reassemble the boiler in reverse order ensuring all the washers are fitted, or replaced as required.
- Open the isolating valves on flow and return connections, refill, vent and re-pressurise system ensuring the all joints are sound.

18.14 Gas valve

- Ensure that gas supply to boiler is turned off.
- Disconnect the electrical connections to gas valve modulating coil.
- Release the connection from gas valve and manifold inlet, retaining the washers for use on reassembly (figure 41).



Figure 41

- Release the main gas connection between the gas valve supply tube and gas inlet valve, retaining the washer for use on reassembly.

- ❑ Remove the gas valve's two securing screws and washers from the underside of the boiler (*figure 42*).

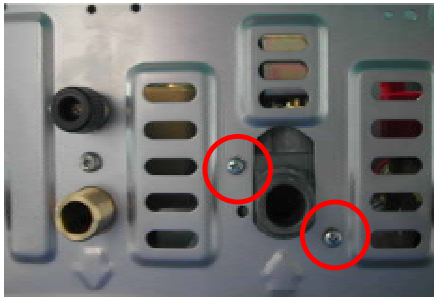

Figure 42

- ❑ Rotate the gas pipe and withdraw gas valve assembly.
- ❑ Refit in reverse order to removal, the polarity of the wires to the modulating coil is not important, replace any damaged washers as required.
- ❑ Check gas soundness and correct boiler operation.
- ❑ Following replacement the maximum and minimum settings for natural gas must be checked to ensure they are 12.7 mbar / 2.0 mbar for the Vizo 24 and 11.6 mbar / 3.5 mbar for Vizo 28 respectively.
- ❑ Check the gas valve settings and re-calibrated by the following method if required:

18.15.1 Minimum setting

- ❑ Remove one lead from the modulating gas valve coil. (*Figure 43*)
- ❑ Connect a suitable pressure gauge to the pressure outlet on the gas valve.
- ❑ Turn the boiler's function switch to the 'Winter' position. (Heating & Hot Water)
- ❑ Turn the central heating temperature control to maximum setting.
- ❑ Remove the protective cover from the gas valve adjuster.
- ❑ Turn the inner screw using a screwdriver, **clockwise**: to increase the pressure setting, **anticlockwise**: to decrease the pressure setting. (*figure 44*)
- ❑ After correct adjustment see Technical Data page 5, re-connect the electrical connector and protective cover.

18.15.2 Maximum setting

- ❑ Remove the protective cover from the gas valve adjuster.
- ❑ Push the ball inside the modulating gas valve coil using a sharp pointed tool. (*figure 45*)
- ❑ Turn the nut with a 10mm spanner (keeping the ball in without any rotation) **clockwise**: to increase the pressure setting, **anticlockwise**: to decrease the pressure setting.
- ❑ After correct adjustment see Technical Data page 5, refit the cover to the gas valve adjuster.



Figure 43



Figure 44



Figure 45

18.16 Expansion vessel

- ❑ Drain the boiler's hydraulic circuit as detailed in (18.2).
- ❑ Disconnect the pipe coupling on expansion vessel (figure 46).
- ❑ Release and remove the nut securing the expansion vessel to the boiler.

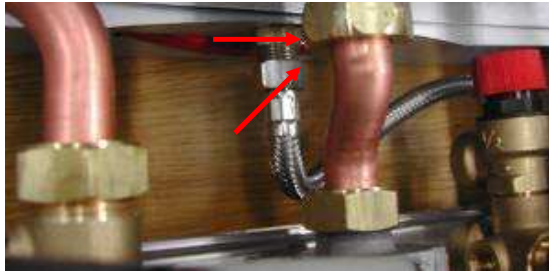

Figure 46

- ❑ Remove the side panels as described in section 17.
- ❑ Lift the vessel out of boiler from the gap over the chasis (figure 47) and fit the replacement vessel to the boiler in reverse order to removal, ensuring that sealing washer is fitted to pipe connection before tightening, replace the washer if necessary.

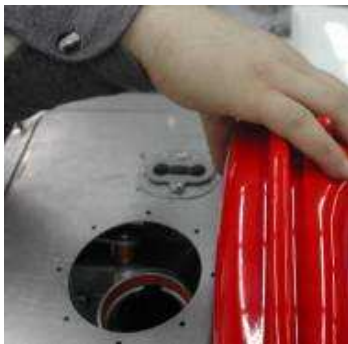

Figure 47

- ❑ Using a pressure gauge, ensure that expansion vessel charge pressure is 0.5bar (7.5psi)
- ❑ Open the isolating valves on the flow and return connections, refill, vent and pressurise the boiler ensuring all joints are sound.

18.17 Overheat safety thermostats

- ❑ Remove the front panel, combustion chamber cover and right side panel.
- ❑ Locate the overheat safety thermostats at the front left handside of



Figure 48a

the boiler and on the right handside of the primary heat exchanger (figures 48a & b).

- ❑ Disconnect the electrical connections from the thermostat.
- ❑ Unclip the thermostat from the pipe.
- ❑ Fit the replacement thermostat in reverse order of removal.



Figure 48b

18.18 Pressure relief valve (figure 55).

- ❑ Drain the boiler's hydraulic circuit as detailed in (18.2).
- ❑ Disconnect the discharge pipe on the outlet of the safety valve.
- ❑ Remove the safety valve from the hydraulic block and retain the o-ring for use on reassembly, replace as necessary.
- ❑ Fit the replacement safety valve in reverse order to removal and refill, vent and pressurise boiler ensuring all joints are sound.



Figure 49

18.19 Hydroblock

- ❑ Drain the boiler's hydraulic circuit as detailed in (18.2).
- ❑ Remove the secondary heat exchanger as described in (18.12)
- ❑ Remove the pump assembly as described in (18.10)
- ❑ Remove the section of the hydroblock from the pump by releasing the clip.

- ❑ Release the exchanger outlet pipe nut and rotate the pipe for easy removal of the left section of the hydroblock as described in section (18.13)
- ❑ Disconnect the three way valve motor, electrical connection and remove the motor by releasing the clip as described in section (18.22)
- ❑ Release the nut connecting the CH outlet connection to the hydroblock. (figure 50).



Figure 50

- ❑ Disconnect the DHW sensor as described in (18.4).
- ❑ Remove the screw securing the left part of the hydroblock to the combination boiler (figure 51).



Figure 51

- ❑ Fit the replacement hydroblock parts in reverse order to removal ensuring all seals are correctly located and replaced if necessary.

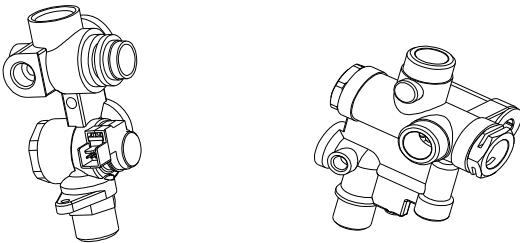

Figure 52

- ❑ Open the isolating valves on the flow and return connections, refill, vent and pressurise boiler ensuring all joints are sound.

18.20 Filter.

- ❑ Drain the boiler's hydraulic circuit as detailed in (18.2).
- ❑ Remove the right section of the hydroblock as described in (18.10).
- ❑ Remove the filter in the inlet to the hydroblock..
- ❑ Clean or fit a replacement filter.
- ❑ Fit the components in reverse order of removal, ensuring all seals are correctly located and replaced if damaged.
- ❑ Open the isolating valves on the flow and return connections, refill, vent and pressurise the boiler ensuring all joints are sound.

18.21 Flow sensor

- ❑ Remove the flow sensor using a pair of pliers.



Figure 53

- ❑ Fit a replacement sensor in reverse order to removal.

18.22 Three way valve motor

- ❑ Ensure that the electric supply to the boiler is switched OFF.
- ❑ Remove the electrical connection to the motor.



Figure 54

- ❑ Remove the clips connecting the valve to hydroblock.



Figure 55

Fit the replacement valve in reverse order ensuring the valve is fitted properly.

19. Gas Type Conversion

Warning

Gas conversion must be carried out by a competent person as defined in the Gas Safety and Use Regulations.

19.1 If gas type conversion is required (from NG to LPG etc.), follow the steps below:

- ❑ The burner must be removed to reach the injector bar as described in **17.7**.
- ❑ Remove the old injectors from the burner injector bar.
- ❑ Fit the new burner injectors to the injector bar and tighten, ensuring that the injector size, marked on each injector is the same as stated in the relevant section of the **'Technical Data'** for the type of gas that will be used.
- ❑ Fit the burner (replace if necessary) and reassemble the boiler.
- ❑ Check for gas soundness.
- ❑ Change the position of Dip Switches 1 & 7 on main PCB: Figure 19 on page 21.

Dip 1 OFF NG (Dip 7 OFF) LPG
(Dip 7 ON)

- ❑ Adjust the minimum and maximum burner pressures as described in **18.15.1** and **18.15.2**. See Technical Data page 5 for LPG details.

- ❑ Check the gas circuit for soundness and the correct operation of the boiler.

Important.

Attach the labels supplied as follows:

- Replace the adhesive "User Instruction" label.
- Stick the LPG label in a prominent position within the boiler.
- Stick the foil label over the existing gas type on the data plate of the boiler.

Chart II Check Domestic Hot Water Operation

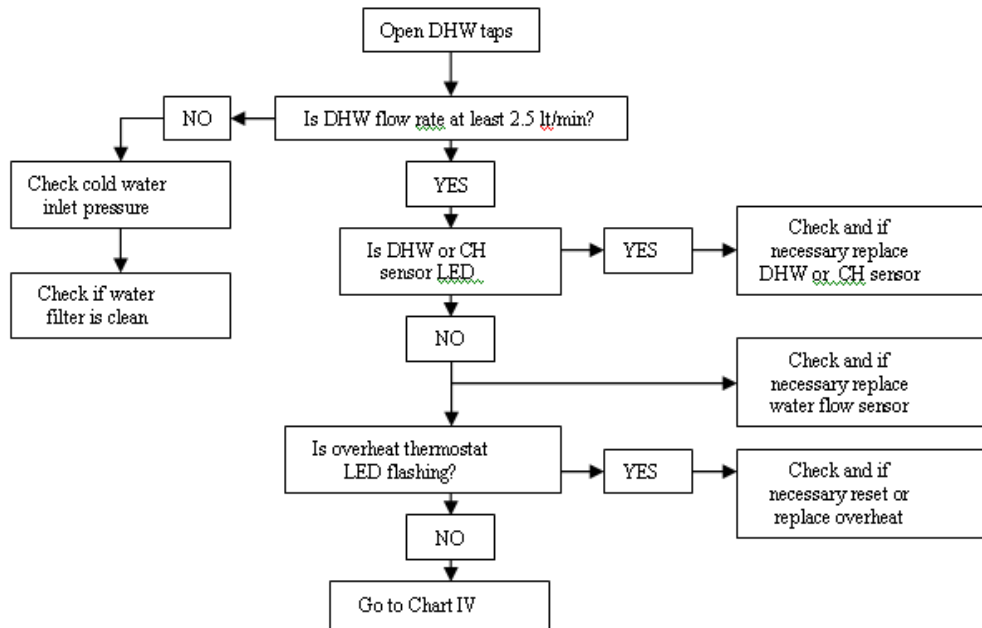

Chart III Check Central Heating

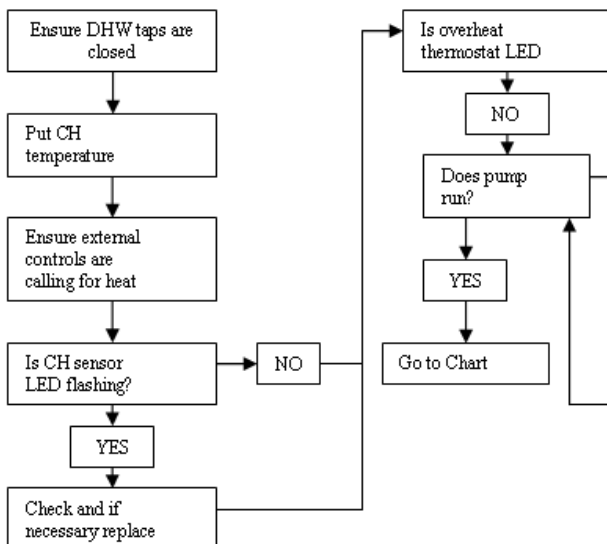

Chart II
Check Domestic Hot Water Operation

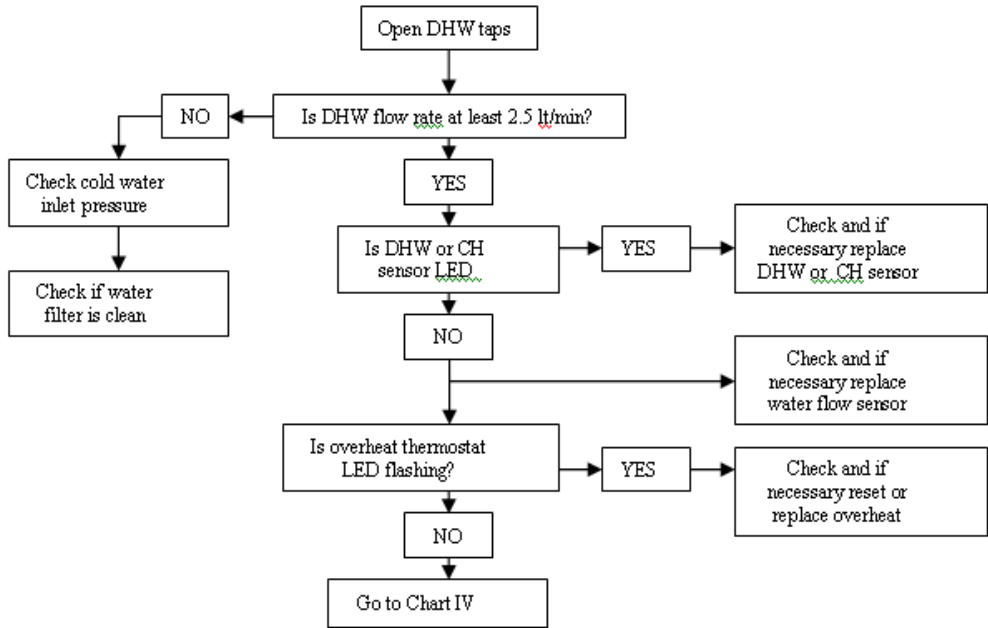

Chart III
Check Central Heating

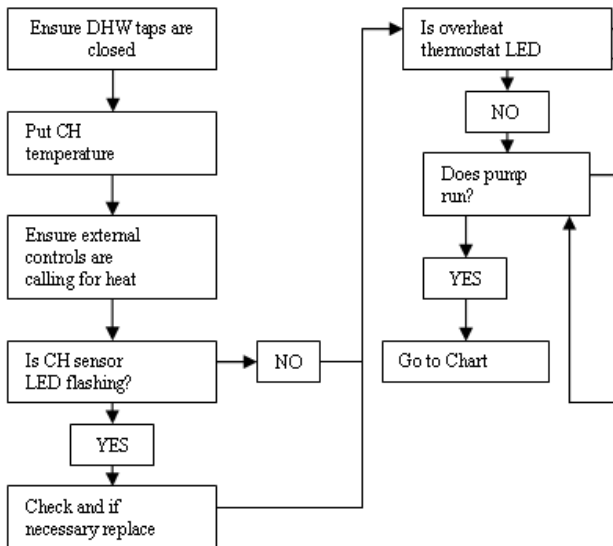
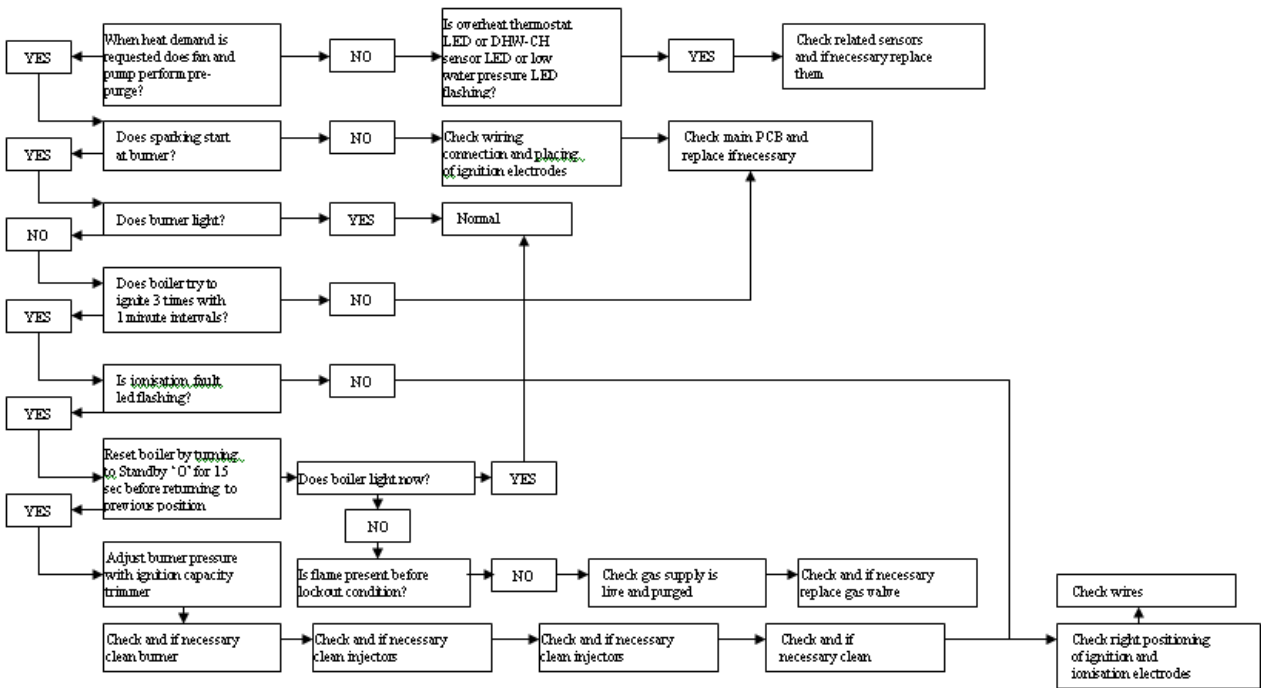

Chart VI
Check Ignition System



Spare Parts List

APPENDIX

PART No.	DESCRIPTION	ORDER CODE
1	HYDROBLOCK – THREE PORT VALVE	3003200017
2	HYDROBLOCK – PUMP SECTION	3003200018
3	LOW WATER PRESSURE SWITCH	3003200038
4	SAFETY VALVE	3003200019
5	PUMP	3003200022
6	EXPANSION VESSEL	3003200028
7	GAS VALVE	3003200419
8	BURNER (FOR Vizo24)	3001010002
9	BURNER (FOR Vizo28)	3001010003
10	CONTROL PANEL	3003200081
11	PCB COVER	3003200084
12	ELECTRONIC CONTROL CARD	3003200907
13	INTERFACE CARD	3003200012
14	SECONDARY HEAT EXCHANGER	3003200026
15	SECONDARY HEAT EXCHANGER	3003200025
16	DHW SENSOR (NTC)	3003200031
17	CH SENSOR (NTC)	3003200152
18	WATER PRESSURE GAUGE	3004090673
19	OVERHEAT SAFETY VALVE	3002185050
20	IGNITION ELECTRODES (RIGHT /	3003200033 / 34
21	FLAME SENSE ELECTRODE	3003200035
22	FAN	3003200906
23	AIR PRESSURE SWITCH (FOR Vizo24)	3003200909
24	AIR PRESSURE SWITCH (FOR Vizo28)	3003201036
25	FRONT PANEL (FOR Vizo24)	3003200068
26	FRONT PANEL (FOR Vizo28)	3003200069
27	CONDENSING TRAP	3003200461
28	TURBO EXCHANGER	3003200486
29	DIVERTER VALVE	3003200017
30	DIVERTER MOTOR	3003200039
31	FLOW SENSOR	3003200374



Vizo 24 / 28
Wall Mounted
Combination Boiler
User Instructions



Natural Gas

HEATLINE™ Vizo24 / Vizo28 Condensing Combination Boilers

British Gas Service Listing

Vizo 24 Condensing Combination Boiler G.C.No 47-157-08

Vizo 28 Condensing Combination Boiler G.C.No 47-157-09

The HEATLINE™ range of heating boilers is manufactured from high quality materials, enabling reliability and optimum performance.

HEATLINE™ are committed to the continual development of their appliances to ensure their customers benefit from the latest advances in combustion technology and energy savings.

Type test for purpose of Regulation 5 certified by:

Notified Body IMQ **51BP2727** CE Directives 90/396/EEC
51BP2728DR CE Directives 92/42/EEC

Product/Production certified by:

Notified Body IMQ **51BP2727** CE Directives 90/396/EEC
51BP2728DR CE Directives 92/42/EEC

The manufacturer, in the continuous process to improve his products, reserves the right to modify the data expressed in the present documentation at any time and without prior notice.

The present documentation is an informative support and it cannot be considered as a contract towards third parties.



'Benchmark' Log Book

As part of the industry-wide initiative the Vizo24/Vizo28 boilers come complete with an Installation, Commissioning and Service Record Log Book. Please read the Log book carefully and in accordance with current regulations complete all sections relevant to the appliance and installation. The details within the Log Book will be required in the event of any warranty work.

On completion, the Log Book must be left with the end user and the relevant sections completed on each subsequent Service visit.

IMPORTANT INFORMATION

The HEATLINE™ Vizo24 / Vizo28 is a high efficiency gas fired boiler and represents the highest level of technology found in today's gas boiler market.

In order to maintain peak efficiency and performance your boiler must be serviced annually. This should be undertaken by a competent C.O.R.G.I. registered engineer. Failure to undertake this service work may invalidate your warranty.

All C.O.R.G.I. Registered Installers carry a C.O.R.G.I. ID card and have a registration number, which should be recorded and entered on your benchmark log book. You can check your Installer registration by contacting C.O.R.G.I. on 0870 401 2300.

The boiler's '**Log Book**' must be completed at each Service visit.

GAS SAFETY (INSTALLATION AND USE) REGULATIONS

It is a legal requirement that all gas appliances must be installed and serviced by a competent person in accordance with the regulations. Failure to install or service gas appliances correctly could lead to prosecution. It is in your interest and that of safety to ensure compliance with the law.

For electrical safety the boiler must be earthed and protected by a **3-amp fuse**.

Note. In the event of a fault the appliance should not be used until fault has been rectified by a competent person.

VENTILATION

For maintenance and safety purposes, the boiler has been installed with a minimum space of 200mm above, 300mm below, 600mm to the front and 50mm to either side of the boiler case. It is essential that this space is not restricted by the addition of shelves etc. fitted above or below the boiler, or to the boiler sides.

GENERAL DESCRIPTION OF BOILER

The Vizo24 / Vizo28 are combined domestic hot water and central heating appliances. The internal control unit electronically provides direct burner ignition and combustion supervision along with continuous modulation of the burner's gas supply.

By means of a manual switch the Vizo24 / Vizo28 can be set to operate in one of two operating modes, domestic hot water only or domestic hot water and central heating.

DOMESTIC HOT WATER MODE:

When hot water demand is requested the boiler will fire automatically. An integral pump is then energised and hot water from the boilers primary circuit is circulated through the secondary heat exchanger, allowing the instantaneous transferral of heat to the incoming cold water. The secondary heat exchanger is protected against an internal build up of lime scale by limiting the hot water temperature at the tap to a maximum of 65°C. Hot water will continue to flow through the tap until no longer required. When the demand for hot water ceases the integral pump may continue to run for a short while to dissipate any excess heat within the boiler.

DOMESTIC HOT WATER AND CENTRAL HEATING MODE: ACCESS TO THE BOILER CONTROLS

When heating demand is requested the boiler will fire automatically. An integral pump is then energised and hot water from the boiler's primary circuit is circulated around the heating systems pipe-work and radiators. The heat output from the boiler is automatically adjusted by the boiler's internal control unit to match the heating demand. As the water temperature of the heating system increases the gas input to the burner decreases, conserving energy and increasing efficiency. When the demand for heating no longer exists, either the room thermostat is satisfied or the heating period has ended, the burner will shut down and the boiler will revert to stand-by, waiting to respond to the next heating demand. The integral pump may continue to run after shut down for a short while to dissipate any excess heat within the boiler.



The Vizo24 / Vizo28 boiler controls are sited at the bottom of the boiler's front case. (fig.1)

Figure 1

Please Note. When domestic hot water is called for during the heating mode, the boiler will automatically revert to domestic hot water mode until the demand for hot water ceases.

NOTE: Depending on the boiler set up there may be a delay of 45secs before the boiler re-fires.

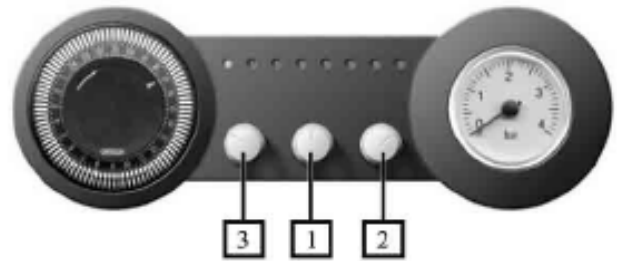







Figure 2

BOILER CONTROLS

The function and operation of the main controls located on the control panel fascia (fig.2) is as follows:

1. **(Function switch.)** This is the boilers main operating switch.

In the  position the boiler is in stand-by mode and power supply is ON. For the boiler to operate the switch must be in the  or  position.

When switched to the  position the boiler will operate only to supply domestic hot water. (Summer use) For the boiler to operate to give both central heating and domestic hot water the switch must be in the  position (Winter use)

2. **(Central Heating temperature control.)** The position of this control dial will determine the temperature of the water delivered to the radiators. The water temperature can be set from a minimum of 30° C (anticlockwise stop position) to a maximum of 85° C (clockwise stop position.)
3. **(D.H.W. temperature control)** The position of this control dial will determine the temperature of the domestic hot water delivered to the taps or shower unit. The water temperature can be set from a minimum of 35° C (anticlockwise stop position) to a maximum of 64° C (clockwise stop position.)

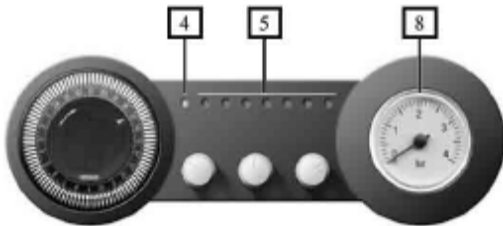

4. **(Boiler On)** The boiler 'Stand by' indicator (green) lights when power is supplied to the PCB.
5. **(Water Temperature)** The temperature of the water leaving the boiler is given by the red light indicators situated alongside the burner 'Stand by' indicator light.
6. **(Fault Indicator)** The Vizo24/Vizo28 control unit has an in-built fault diagnostic function. When a fault occurs, the type of fault is indicated by the appropriately 'flashing' red light indicator. A listing of the display lights and meanings can be found in Section 13 (4) of the Installation and Servicing Instructions.
7. **(Boiler Lockout)** When the first red light indicator from right (flame or gas fault) or the second from right (overheat fault) lights, the boiler will need to re-set. To re-set the boiler the function switch must be switched to the  position and after 30 seconds back to its previous (summer or winter) position.

8. **(Pressure gauge)** The pointer on the gauge indicates the pressure within the boiler and central heating system and should, when the water is cold, read between 1 and 2 bar.

If the pressure gauge falls below 1bar the system and boiler must be re-pressurised.

Note. A Service Engineer must be contacted if a boiler fault continues to occur.



9. **(Clock)** A time clock allowing the automatic switching 'On' and 'Off' of the central heating is fitted as standard as standard

The operational time periods may be set as follows:

- ❑ Rotate the clock actuator mechanism clockwise, by hand, until the arrow indicates the current time, see figure 3. In figure 3 the current time is set at 21:05.
- ❑ The time is set in 24 hour format, e.g. the time for 1pm would be 13.

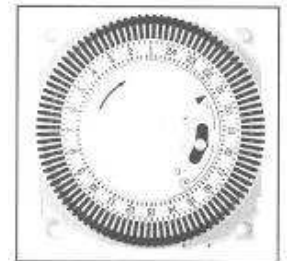



Fig 3

- ❑ Select the "On" times by pushing the black tappets to the outside.
- ❑ Select the 'Off' times by pushing the black tappets towards the centre of the clock.

The clock shown in figure 3 is set as follows:

The clock operation can be set by a selection switch.

The switch has 3 positions:

- 1 (Up) position: The boiler is controlled by the function switch (Item 1 in Figure 3) independent from clock tappets.
-  (Mid) position: The boiler is controlled by both function switch and clock tappets.
- 0 (Down) position: The boiler is off independent from the function switch.

FROST PROTECTION

The boiler has a built in frost protection device that protects the boiler from freezing. If the boiler is to be left and there is a risk of frost, ensure that the gas and electrical supplies are left connected. The frost protection device will light the boiler when the temperature of the boiler water falls below 6°C. When the temperature reaches 15°C, the boiler will shut down. **Note:** This device works irrespective of any room thermostat setting and will protect the boiler, but not necessarily the full system. Ensure that vulnerable sections of the circuit are adequately lagged.

SYSTEM PRESSURE

On installation your installer will have filled the boiler and system to its effective working pressure. The boiler's pressure gauge should be regularly checked to ensure that this pressure is maintained between 1 and 2 bar. If there is a significant or frequent drop in pressure then your installer should be consulted.

OPERATING THE BOILER

On installation your installer will have filled the boiler and system to its effective working pressure. The boiler's pressure sensor should be regularly checked on the LCD to ensure that this pressure is maintained between 1 and 2 bar. If there is a significant loss in pressure the boiler will lock out. The system may be re-charged by opening the filling loop to charge the system back up to 1.5bar as indicated on the LCD panel. **DO NOT OVERCHARGE THE BOILER PRESSURE BEYOND 2BAR AS THE BOILER WILL NOT OPERATE.** The filling loop, a flexible hose with two valves, should be located below the boiler connecting the second pipe on the right to either one of the outer pipes, see *figure 10 on page 19*. **DO NOT CLOSE ANY OF THE FOUR VALVES DIRECTLY CONNECTING TO THE BOILER.** If the boiler frequently loses pressure then your installer should be consulted.

CLEANING

The boiler casing may be cleaned with a damp cloth followed by a dry cloth to polish. **Do not** use abrasive or solvent cleaners.

FURTHER ADVICE

For further advice or information contact HEATLINE™ Service Enquiries by telephone on **0870 609 2091** or e-mail at our web site www.heatline.co.uk

For technical information, please contact HEATLINE™ Technical on **0870 777 8318**.



Heatline
Nottingham Road,
Belper,
Derbyshire,
DE56 1JT

Tel: 01773 596 099
Fax: 01773 828 123
Email: sales@heatline.co.uk