

Grant ESKIT

Electronic, 2-channel full programmer for heating & hot water with service interval timer

Installation & User Instructions



This product complies with the following EC Directives:

Electro-Magnetic Compatibility Directive.

(EMC) (89\336\EEC), (92\31\EEC)

Low Voltage Directive.

(LVD) (73\23\EEC), (93\68\EEC)



Index

Installation Instructions

Product specification and Installation	3
Installation and Wiring	4
DIL switch settings	5
Advanced Programming Options	5
Copy Functions	6-7
Service Interval Timer	7
Wiring Conversion	8-15

User Instructions

What is a Programmer?	16
Your programmer	17
Preset programmes	17
Resetting the unit	18
24hr or AM/PM display	18
Setting the Date, Time and Day	18-19
Accepting the preset programmes	19
Changing the preset programmes	20
Programming heating - 5/2 day	21-22
Programming heating - 7 day	23-24
Programming heating - 24 hour	25
Programming hot water	26
Running the programme	27
Temporary overrides	28
Holiday Programme	29
Changing clocks forward/back	30
Service Interval Timer	31
Fully Resetting the Unit	32

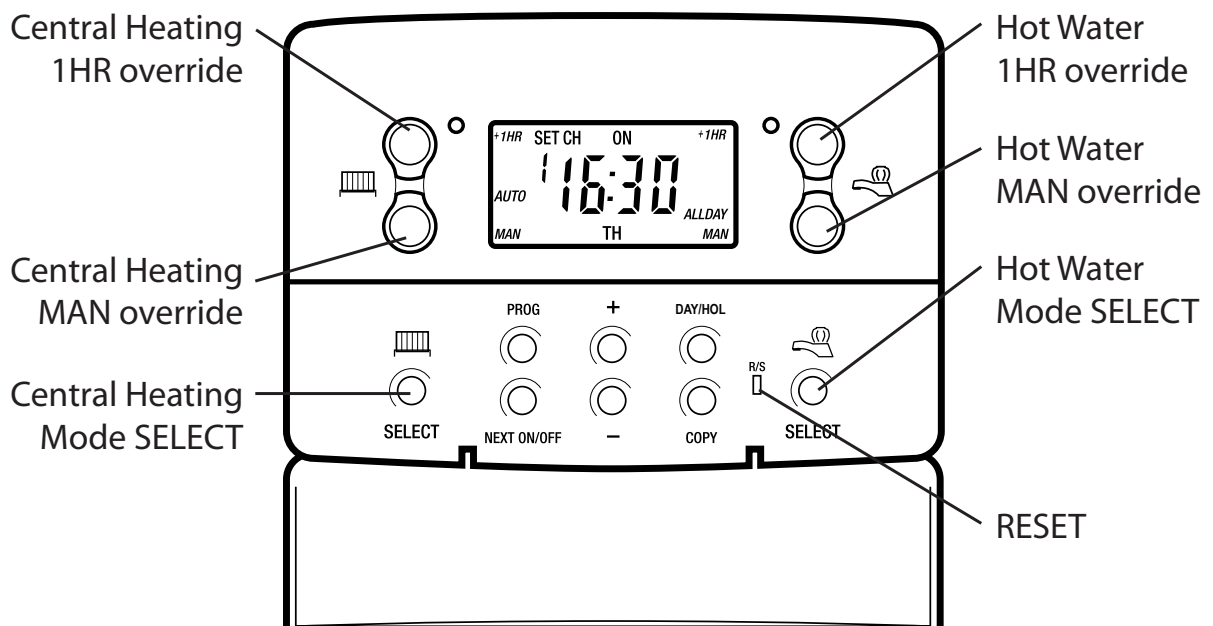

Installation Instructions

Please Note: This product should only be installed by a qualified electrician or competent heating installer, and should be in accordance with the current edition of the IEEE wiring regulations.

Product specification

Specification	230V model	24V model
Power supply	230 Vac, ±15%, 50/60 Hz	24 Vac, ±15%, 50/60 Hz
Switching action	2 x SPDT internally linked, Type 1B	
Unit switch rating	230 Vac, 3(1)A	24Vac, 3(1)A
Battery back-up	24 hours minimum	
Programme resolution	± 1 minute	
Dimensions, mm (W, H, D)	135 x 88 x 32	
Design standard	EN 60730-2-7	
Control Pollution Situation	Degree 2	
Rated Impulse Voltage	2.5 kV	
Ball Pressure Test	75°C	

Installation

- Remove wallplate from unit by unscrewing the two screws on the bottom edge of the unit.
- From the top left hand corner of the wallplate, there must be clearances of at least 140 mm to the right, 15mm to the left, 30mm above and 100mm below in order to mount the plug-on module.

Installation and Wiring

- The wallplate must be securely mounted either directly to the wall using suitable wood screws or to a flush mounted 1-gang electrical accessory box using M3.5 screws.
- Cable access can either be from behind for concealed cabling, or from below for surface cabling. If surface cable is used, cut out cable access slot on plug-on module prior to mounting.
- For wiring connections refer to diagram below.

ESKIT models are double insulated and do not require an earth connection, however a parking terminal is provided on the wallplate. This is clearly marked with an Earth symbol.

- Prior to mounting the plug-on module, DIL switches on the rear of the plug-on module must be set. See diagram on page 5 for available options.
- Mount plug-on module to wallplate by locating tabs on top of wallplate in apertures on rear of module, hinge down and press firmly to wallplate before tightening securing screws on bottom of wallplate.

Wiring (*For Wiring Conversion tables see - pages 8-15*)

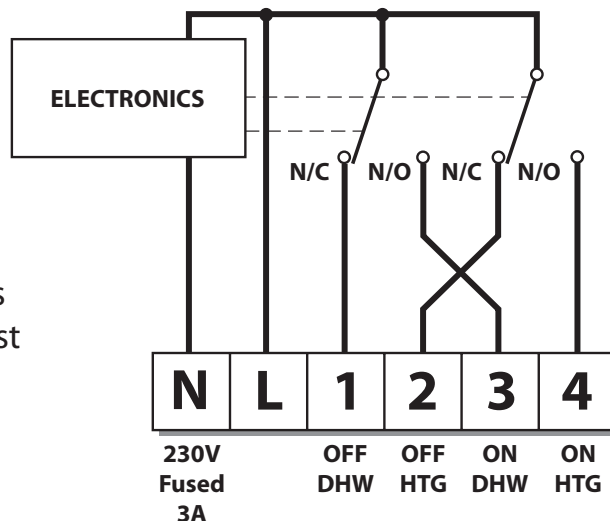

Please Note:
On 24 volt models power supply must be wired to A & B on wallplate.

Always switch off mains first and never fit programmer to a live wallplate.

DIL Switch Settings

Before mounting the unit, ensure the 4 DIL switches on the rear have been moved to the required settings.

! Tick the **INSTALLER SETTING** box on the inside flap label to notify user in which mode their unit is set (24hr, 5/2 day or 7 day).

Sw.1	Not Used	<input type="checkbox"/>	Not Used
Sw.2	Gravity	<input type="checkbox"/>	Pumped
Sw.3	5/2 Day	<input type="checkbox"/>	7 Day or 24 Hour
Sw.4	7 Day	<input type="checkbox"/>	24 Hour

INSTALLER SETTING	
24 Hour	<input type="checkbox"/>
5+2 Day	<input type="checkbox"/>
7 Day	<input type="checkbox"/>

Advanced Programming Options

To enter advanced programming press **PROG**, + and **DAY/HOL** together and hold for 5 seconds.

Option 1 - (3 or 2 On/Off's per day)

Use + or - to change between 3 or 2 on/off's each day.



3 on/off's each day (Factory setting)

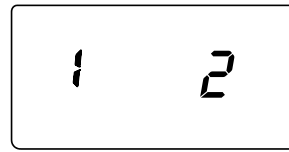

2 on/off's each day

Option 2 - (Disable or enable auto time change)

Press **NEXT**, then use + or - to change between auto time change enabled to auto time change disabled.



Auto time change enabled (Factory setting)

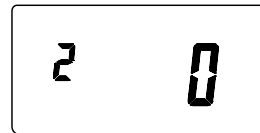

Auto time change disabled

Option 8 - (Advanced Copy Functions)

Press **NEXT**, then + or - to change between the following copy options:

(0) Standard copy in 7 day and 5+2 day.

(1) Enhanced copy in 7 day and 5+2 day

(2) Enhanced copy in 7 day and AB copy in 5+2 day.

For an explanation of the copy features and how to use them please see page 6.

Press **PROG** to return to **RUN**.

Copy Functions Explained

There are 3 possible copy functions available. These are; **Standard Copy**, **Enhanced Copy**, and **AB copy**. Copy functions are enabled/disabled in the Advanced Programming Options (page 5).

Standard Copy: Pressing copy will copy the previous days events into the displayed day. The unit will then display the 1st event for the new day. This copy function is present only if the unit is set to run in **5+2 or 7 day mode**.

Enhanced Copy: The enhanced copy function is available in **7 day mode only**. This allows any day to be copied to any other day, or days. To use the enhanced copy function go into the event programming using the **PROG** button, then:

1. Use the **DAY** button to find the day to be copied from.
2. Press the **COPY** button to select the day to be copied from. When selected, the day should begin to flash.
3. Use the **DAY** button to find the day to be copied to.
4. Press **COPY** button to copy the selected day.
5. Repeat steps 3 and 4 to select and copy other days.
6. To stop copying, use the **DAY** button to go back to the flashing day and press the **COPY** button. The previously flashing day will stop flashing to indicate it has been de-selected.

NOTE: When a day has been copied to, it will remain visible and not flashing when the DAY button is used to select other days.

AB Copy: The AB copy function is available in **5+2 mode only** and only if activated in the Advanced Programming setting.

A and B days, when selected, can be any group of days e.g. 5+2, 4+3 etc. The days do not have to run in sequence. For example, to operate in a 5+2 day mode the days can be set as follows:

A Days	B Days
Mon Tues Thurs Fri Sat	Wed Sun

To use the AB copy function – press the **PROG** button:

1. This will show the “A” days, with all the days selected.
2. Use the **DAY** button to highlight a day.
3. Subsequent presses of the **DAY** button will increment through the days.
4. Press the + button to select a specific day as an “A” day, or press the – button to specify a day as a “B” day.
5. Once the day has been selected as an “A” or “B” day the programme will automatically jump to the next day.
6. When the last day of the week is active, pressing +, -, or **DAY** will move back to the “A” days displayed with no selected (flashing) days (see image below).
7. Repeat 2 to 6 until all selections have been made.
8. When selections are completed, press the **PROG** button to move to event programming.

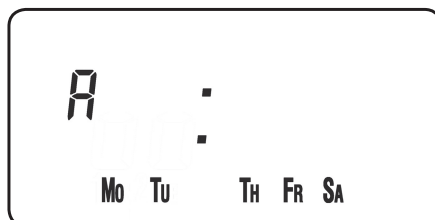

Event Programming in AB mode

1. Programme “A” day events using the + (time advance), - (time decrease), and **NEXT** (next period) buttons.
2. Press the **DAY** button to change to programme the “B” days
3. Programme “B” day events using the + (time advance), - (time decrease), and **NEXT** (next period) buttons.

Service Interval Timer

The ESKIT is fitted with an installer setback service interval timer. If this feature is required please contact our technical department. Setting instructions for this gas safety feature are only available to bona fide heating installers.

Wiring Conversions, (applies only to 230 volt models)

Wiring conversions can be used when replacing the following programmers with the ESKIT. Some time controls are connected differently depending on the type of system they are controlling. Consult the column headed "NOTE This conversion ..." to determine whether **Table A (pages 8-11)** or































Table A GRANT ESKIT (PUMPED)	MAINS			DHW OFF	HTG OFF	DHW ON
		N	L	1	2	3
DANFOSS RANDALL 922/972		N	L	1	4	3
DANFOSS RANDALL 4033		7	6	5	3	4
DANFOSS RANDALL SET 5		N	L	3	6	1
HORSTMANN 423, AMETHYST 7 & 10		2,3	1	4	6	5
HORSTMANN 424 GEM		2,3	1,10	6	9	4
HORSTMANN LEUCITE 423 & 424		2	1	4	8	3
HORSTMANN 425 DIADEM		N	L	3	6	1
HORSTMANN 525 & 527		N	L	3	6	1
HONEYWELL ST669		N	L	7	4	6
HONEYWELL ST6300 & ST6400		N	L	1	2	3
PEGLER SUNVIC SP50/SP100		N	L	1	4	2
POTTERTON EP2000, EP3000		N	L	1	2	3
RANDALL TSR3+3		3,6	7	2	5	1
RANDALL 3033		1,7	6	5	3	4
RANDALL 702		N	L	4	2	3
SANGAMO FORM 1 410 & 414		4,5	6	2	7	1
SANGAMO S409/1		N,1,3	L	-	-	2

Table B (pages 12-15) should be used. If in any doubt, contact our Technical Services Department before proceeding with the replacement. *Any wires connected to switch COMMONS which are linked LIVE on existing wallplates must be transferred to the LIVE terminal on the new wallplate.

HTG ON	Wires other than links in these terms go to LIVE		NOTE This conversion applies only if....	An additional terminal block may be required where these disconnected leads (or pairs) should be terminated			
	L	L		A	B	C	D
4	2	5	Programmed selectors UNLINKED				
2	1	-					
4	2	5					
7	-	-		8			
7	5	8	Terminals 5,8 & 10 are LINKED				
6	5	7	Terminals 5 & 7 are LINKED				
4	2	5	Programme selectors UNLINKED				
4	2	5	Programme selectors UNLINKED				
3	8	5					
4	-	-					
5	3	-		S	S		
4	-	5	Programme selectors UNLINKED	A	B	C	D
4	-	-					
2	-	-					
1	6	5					
8	3	-					
5	-	-					

Table A cont.. GRANT ESKIT (PUMPED)	MAINS			DHW OFF	HTG OFF	DHW ON
		N	L	1	2	3
SANGAMO S409/3		3,6	7	4	2	5
SATCHWELL LIBRA & DHP 2201		1	2	8	5	6
SATCHWELL ET 1401 & 1451		1	2	8	5	7
SMITHS IND. CENTROLLER 90		1	2	-	-	5
SMITHS IND. CENTROLLER 1000		N	L	1	2	3
SWITCHMASTER 800 & 805		N	L	4	2	3
SWITCHMASTER 900 & 9000		N	L	4	2	3
SWITCHMASTER SONATA		N	L	3	6	1
VENNER CHC/W2 (WITH STAT)		N,2,4	L	-	-	1
VENNER CHC/W2 (AIR STAT LINKED)		N,2,4	L	-	-	1
VENNER VENOTROL 80M & 80PM (WITH AIR STAT)		N,3	L	1	4	2
VENNER VENOTROL 80M & 80PM (AIR STAT LINKED)		N,3	L	1	4	2

V	HTG ON	Wires other than links in these terms go to LIVE		NOTE This conversion applies only if....	An additional terminal block may be required where these disconnected leads (or pairs) should be terminated			
		L	L		A	B	C	D
	4	L	L					
	1	-	-					
	3	7	4					
	4	6	3					
	4	-	-		3	6		
	4	-	-	Programme selectors UNLINKED				
	1	-	-					
	1	-	-	Programme selectors UNLINKED	A	B	C	
	4	-	-					
	A/S	-	-	Used in a system having independent control of water and heating	A/S 3			
	3	-	-					
	A/S	-	-		A/S 5			
	5	-	-					

Wiring Conversions

Table B GRANT ESKIT (PUMPED)	MAINS			DHW OFF	HTG OFF	D
	⏏	N	L	1	2	
DANFOSS RANDALL 922/972	⏏	N	L	1	4	
DANFOSS RANDALL 102/102E/102E7	⏏	5	3,6	-	-	
HORSTMANN 423 DIAMOND POTTERTON 423	⏏	N	L,1,3	-	-	
HORSTMANN 424 DIAMOND	⏏	N	L,1,3	-	-	
HORSTMANN CORAL 423 & 424	⏏	2,3	1	-	-	BO
HORSTMANN 425 DIADEM	⏏	N	L	3	6	
HORSTMANN 525 & 527	⏏	N	L	3	6	
HONEYWELL ST669	⏏	N	L	-	-	
POTTERTON EP2000, EP3000	⏏	N	L	1	2	
RANDALL TSR2P	⏏	3	1,2	-	-	
RANDALL MKII R6	⏏	3	1,2	-	-	
DANFOSS RANDALL 3060 & 3020P	⏏	1,7	6	-	-	
RANDALL 701	⏏	N	L	4	2	
DANFOSS RANDALL SET 2	⏏	N	L	3	6	
SANGAMO M5 410 FORM 4	⏏	4,5	3	2	7	
SANGAMO S409 FORMS 1 & 4	⏏	N,1,3	L	-	-	
SANGAMO (EARLY MODEL) S410 FORM 4	⏏	N,2	L	-	-	
SATCHWELL LIBRA	⏏	1	2	8	5	

Wiring Conversions

HW ON	HTG ON	Wires other than links in these terms to LIVE		NOTE This conversion applies only if....	An additional terminal block may be required where these disconnected leads (or pairs) should be terminated			
		L	L		A	B	C	D
3	4	L	L					
3	6	2	5	Programmed selectors UNLINKED				
1	2	-	-					
2	4	-	-		5	6		
2	4	-	-		5			
JILER (8)	AIR STAT (8)	-	-		4,7	5	6	
1	4	2	5	Programme selectors UNLINKED				
1	4	2	5	Programme selectors UNLINKED				
8	7,3	6	5	...set for gravity HW				
3	4	-	5	Programme selectors UNLINKED	A	B	C	D
5,6	7	-	-	1 & 2 are LINKED 5 & 6 are LINKED	4			
4	5	-	-		6	7		
4	2	-	-		3	5		
3	1	6	5					
1,5	4	2	-	With Links L-2 & 1-5				
1,6	8	-	-	1 & 6 are LINKED				
2	5	-	-		6,4			
1,3	4	-	-	1 & 3 are LINKED				
6	3	7	4					

Table B cont... GRANT ESKIT (PUMPED)	MAINS			DHW OFF	HTG OFF	DH O
	⏚	N	L	1	2	
SMITHS IND. CENTROLLER 1000	⏚	N	L	-	-	
SMITHS IND. CENTROLLER 60	⏚	1	2	-	-	
SMITHS IND. CENTROLLER 10	⏚	N	L	-	-	
SMITHS IND. CENTROLLER 70	⏚	1	2	-	-	
SMITHS IND. CENTROLLER 1000	⏚	N	L	1	2	
SWITCHMASTER 320 & 350	⏚	N	4,L	-	-	
SWITCHMASTER 400	⏚	N	L	-	4	
SWITCHMASTER 600	⏚	N	L	-	-	
SWITCHMASTER 900 & 9000	⏚	N	L	4	2	
VENNER VENTROL	⏚	N,A,M	L,L,1	-	-	
VENNER VENOTROL 80 (AIR STAT)	⏚	N,1, 3,4	L	-	-	
VENNER VENOTROL 80 (AIR STAT LINKED)	⏚	N,1 3,4	L	-	-	
VENNER CHC/W2 (WITH STAT)	⏚	N,2,4	L	-	-	
VENNER CHC/W2 (AIR STAT LINKED)	⏚	N,2,4	L	-	-	
VENNER VENOTROL 80P (WITH AIR STAT)	⏚	N,1,3	L	-	4	
VENNER VENETROL 80P (AIR STAT LINKED)	⏚	N,1,3	L	-	4	

HW ON	HTG ON	Wires other than links in these terms to LIVE		NOTE This conversion applies only if....	An additional terminal block may be required where these discon- nected leads (or pairs) should be terminated			
		L	L		A	B	C	D
3	4	-	-		1	4		
5	4	-	-		3			
3	2	-	-		1,4			
5	4	-	-		3	6		
3	4	-	-	Programme selectors UNLINKED				
3	1	-	-	L & 4 are LINKED	2			
3	1	-	-		2			
3	1	-	-		2	4		
3	1	-	-	Programme selectors UNLINKED	A	B	C	
V	S,F	-	-		T,P	O		
2	A/S	-	-		A/S 5			
2	5	-	-					
1	A/S	-	-	Used in a system having control of WATER ONLY or WATER & HEATING TOGETHER	A/S 3			
1	3	-	-					
2	A/S	-	-		A/S 5			
2	5	-	-		6,4			



The text below has been edited and approved by the Plain English Campaign, who has issued a Crystal Mark to be displayed with it.

What is a programmer?

... an explanation for householders.

Programmers allow you to set 'On' and 'Off' time periods. Some models switch the central heating and domestic hot water on and off at the same time, while others allow the domestic hot water and heating to come on and go off at different times.

Set the 'On' and 'Off' time periods to suit your own lifestyle. On some programmers you must also set whether you want the heating and hot water to run continuously, run under the chosen 'On' and 'Off' heating periods, or be permanently off.

The time on the programmer must be correct. Some types have to be adjusted in spring and autumn at the changes between Greenwich Mean Time and British Summer Time.

You may be able to temporarily adjust the heating programme, for example, 'Override', 'Advance' or 'Boost'. These are explained in the manufacturer's instructions.

The heating will not work if the room thermostat has switched the heating off. And, if you have a hot-water cylinder, the water heating will not work if the cylinder thermostat detects that the hot water has reached the correct temperature.

User Instructions

Your programmer

The ESKIT allows you to switch your heating and hot water on and off at times that suit you.

Your programmer has had the date and time set up during manufacture and will automatically change between Greenwich Mean Time and British Summer Time.

You can programme up to 3 ON/OFF times per day for the heating and the hot water and the two systems can be operated independently.

Preset Programmes

Your ESKIT comes ready programmed with a set of operating times which often suit most people.

Event No.	Hot Water & Heating	Mon-Fri	Sat-Sun**
1	1st ON	6:30	7:30
2	1st OFF	8:30	10:00
3*	2nd ON*	12:00*	12:00*
4*	2nd OFF*	12:00*	12:00*
5	3rd ON	17:00	17:00
6	3rd OFF	22:30	22:30
<p>* Not applicable if unit set to 2 ON/OFF's per day by installer **Not applicable if unit set to 24 hour mode by installer See page 20 for explanations of different settings</p>			

If you want to change any of these settings, you can do so by following the instructions on pages 20-26. First, follow the steps on page 18-19 to set the correct time and date.

Before you start

Open the flap on the front of the clock. Press the **RESET** button using a non-metallic object (e.g. pencil/matchstick) until you hear a click and the 2 red lights on the front of the unit flash once.

This will stop and restart the electronics, without losing the factory set time and date settings.

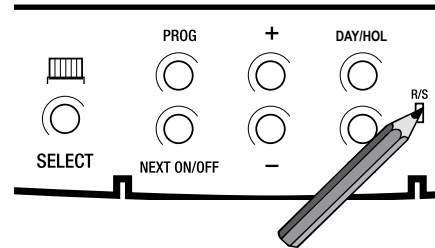

To fully reset the unit see page 32.

Choice of 24hr or AM/PM display

Press and hold **DAY/HOL & NEXT ON/OFF** for 1.5 seconds to toggle between 24hr clock and AM/PM display, as required.

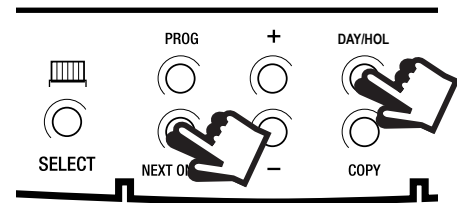

Setting the Date and Time

These settings are made during manufacture and only need to be made in the unlikely event that the unit has lost the settings.

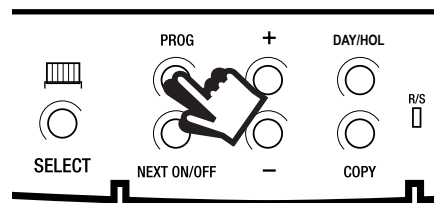

Setting the Date

Press and hold **PROG** for 5 seconds to display year.

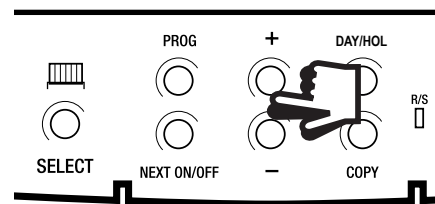

Use the + or - buttons to set the correct year.



Press **DAY/HOL** to display day and month. Use the + or - buttons to set the correct month (Jan = 1, Feb = 2 etc.).

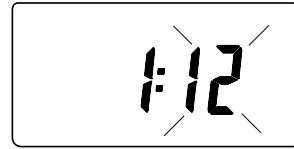

Press **DAY/HOL** to display day and month. Use the + or - buttons to set day of month.

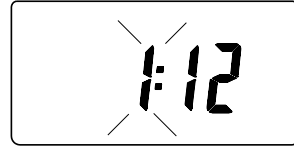

Press **PROG** to display the time.

The words **SET TIME** will appear at the top of the display & the time will flash on and off.



Use the + or - buttons to set the correct time (press and hold to change in 10 min. increments).

Setting the Day

The day of the week is set automatically.

Accepting the preset programmes

If you are happy to use the preset programmes on page 17, you don't need to do anything else.

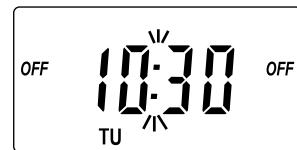

Press the **PROG** button once to return to run mode.

Before you change the preset programmes

Your installer will have set your unit to operate in one of the following modes:

- **5/2 day** - one set of programmes for weekdays and another for weekends (**page 21-22**)
- **7 day** - different settings for each day of the week. (**page 23-24**)
- **24 hour** - one set of programmes for the whole week. (**page 25**)

! See *INSTALLER SETTING* tick box on inside flap label to ascertain which mode your unit is set.

INSTALLER SETTING	
24 Hour	<input type="checkbox"/>
5+2 Day	<input type="checkbox"/>
7 Day	<input type="checkbox"/>

Please Note

The unit must be programmed in sequence and ON/OFF times cannot be set out of sequence.

If you want to leave a preset time as it is, simply press **NEXT** to move on to the next setting

Your installer will have set your unit to programme either 2 or 3 ON/OFF's per day. If your clock has been installed to allow 3 ON/OFF's and you do not wish to use one of the ON/OFF settings, simply programme the ON time to be the same as the OFF time and the setting will not operate.

Programming the heating in 5/2 day mode

1. Press **PROG** once until **SET CH ON TIME** appears at the top of the display and **MOTUWETHFR** appears at the bottom of the display.

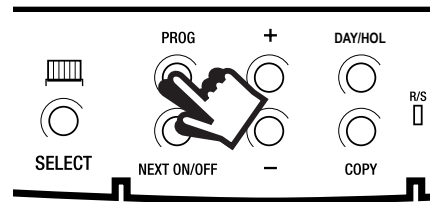

Use the **+** or **-** buttons to set the time you would like your heating to first come on in the morning (Event 1).

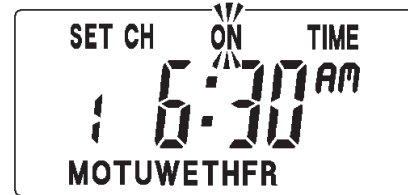

2. Press **NEXT ON/OFF** once only.

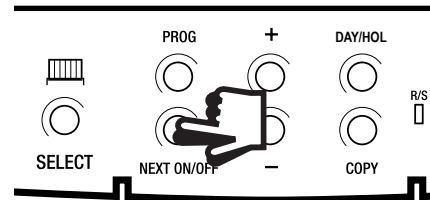

Use the **+** or **-** buttons to set the time you want your heating to go off (Event 2).

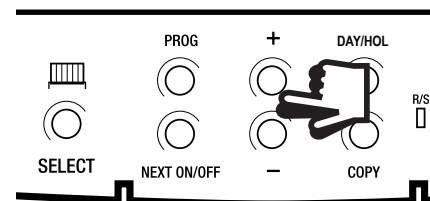

To move to the next setting, i.e. when you would like your heating to come on again (Event 3) press the **NEXT ON/OFF** button again.

3. Continue programming the central heating ON and OFF times for weekday Events 4, 5 & 6 as in Step 2.

4. Press the **DAY/HOL** button once and **SASU** will appear at the bottom of the display.

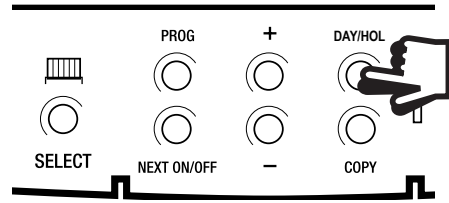

If the same programme is required press the **COPY** button and the previous days programme will be entered.

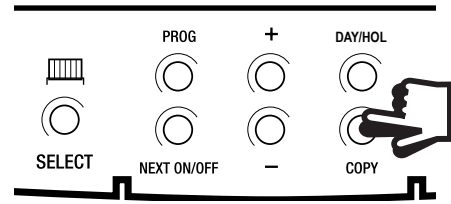

If a different programme is required repeat steps 2-4.

5. Press the **PROG** button once to enter hot water programming or twice to return to run mode.

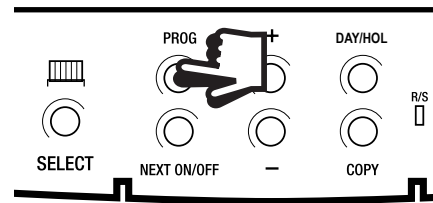

6. **Proceed to page 27.**

Please Note

If this setting is made on a weekend day SASU will show in place of MOTUWETHFR

Programming the heating in 7 day mode

1. Press **PROG** once until **SET CH ON TIME** appears at the top of the display. Note the current day is displayed. Press the **DAY/HOL** button until the required day is displayed.

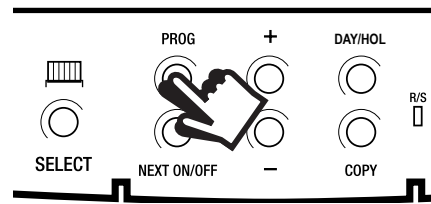

2. Use the **+** **OR** **-** buttons to set the time you want your heating to first come on in the morning (Event 1).

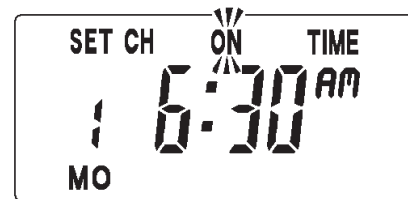

3. Press **NEXT ON/OFF** to move to Event 2.

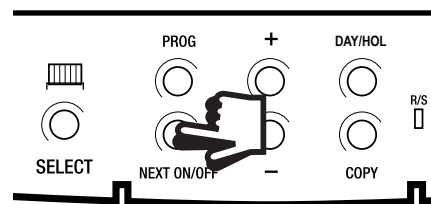

4. Continue programming the central heating **ON** and **OFF** times in this way by using the **+** or **-** buttons to set the time you want and pressing the **NEXT ON/OFF** button to move to the next setting.

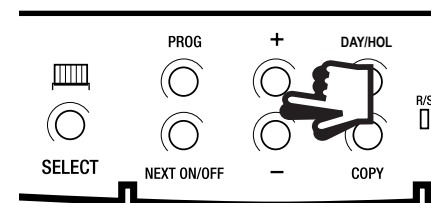

5. Press **DAY/HOL** button once only. The next day will appear at the bottom of the display. Repeat steps 2-5.

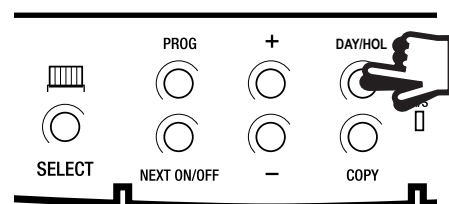

Programming heating - 7 day mode

6. Press the **PROG** twice button to return the unit to **RUN** mode (time appears & colon in the display begins to flash).
7. **Proceed to page 27.**

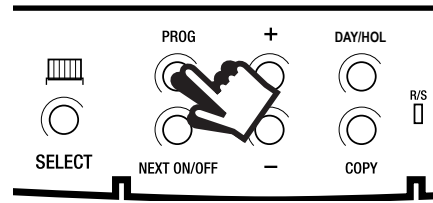

Programming the heating in 24 hour mode

1. Press **PROG** once until **SET CH ON TIME** appears at the top of the display.

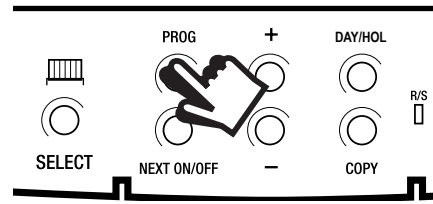

Use the + **OR** - buttons to set the time you want your heating to first come on in the morning (Event 1).

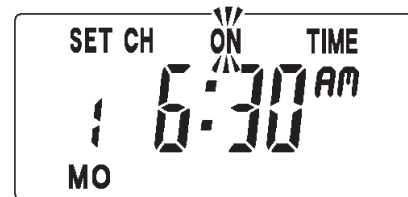

2. Press **NEXT ON/OFF** to move to Event 2.

Continue programming the central heating **ON** and **OFF** times by pressing:

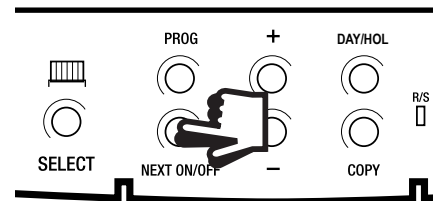

a) **NEXT ON/OFF** button to move to the next setting,

b) + **OR** - buttons to amend the time.

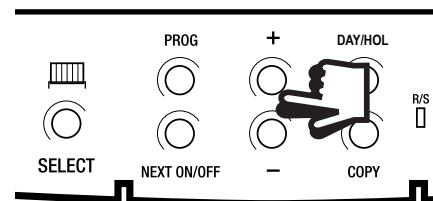

3. Press the **PROG** twice button to return the unit to **RUN** mode (time appears & colon in the display begins to flash).

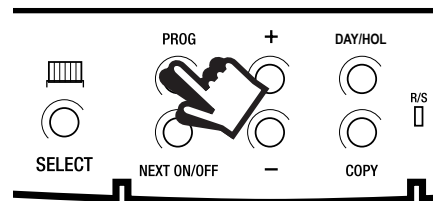

4. **Proceed to page 27.**

Programming the hot water

To set the hot water programme press the **PROG** button twice until **SET HW ON TIME** appears on the display.

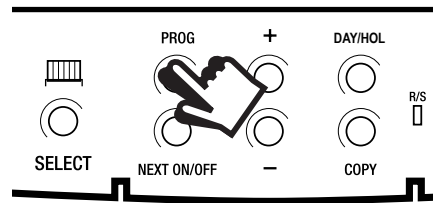

Set the hot water programme in the same way as the heating programme, using:

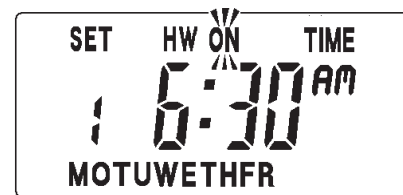

a) **+** and **-** buttons to alter the time,

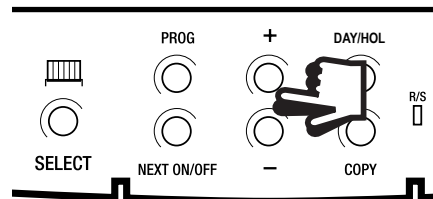

b) Pressing the **NEXT ON/OFF** button to move to the next setting,

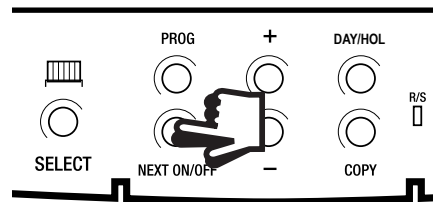

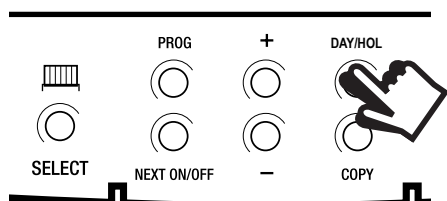

c) Pressing **DAY/HOL** to advance through days of the week (7 day mode) or to advance to Saturday and Sunday programming (5/2 day mode) and repeat steps a-c.



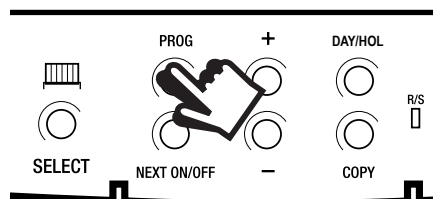

Finally press **PROG** once to return the unit to run mode (time appears & colon in the display begins to flash).



Running your Programme

 **To run the central heating programme:**
 press the **SELECT** button next to the radiator symbol until **AUTO** is displayed in the LCD.

 **To run the hot water programme:**
 press the **SELECT** button next to the tap symbol until **AUTO** is displayed in the LCD.

As you press the **SELECT** button the display will change between **ON**, **OFF**, **ALLDAY** and **AUTO**.

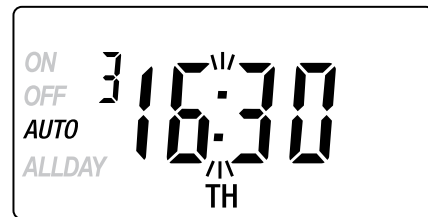

- **AUTO** = the heating/hot water will come on and go off at the programmed times.
- **ON** = the heating/hot water will remain on constantly.
- **OFF** = the heating/hot water will not come on.
- **ALLDAY** = the clock will turn the heating/hot water on at the first programmed ON and will leave it on until your last programmed OFF.

Select the option you require depending on your circumstances, time of year, etc.

Temporary override buttons

Sometimes you may need to change the way you use your heating temporarily, i.e. due to unusually cold weather. The ESKIT has two convenient overrides which can be selected without affecting the set programme.

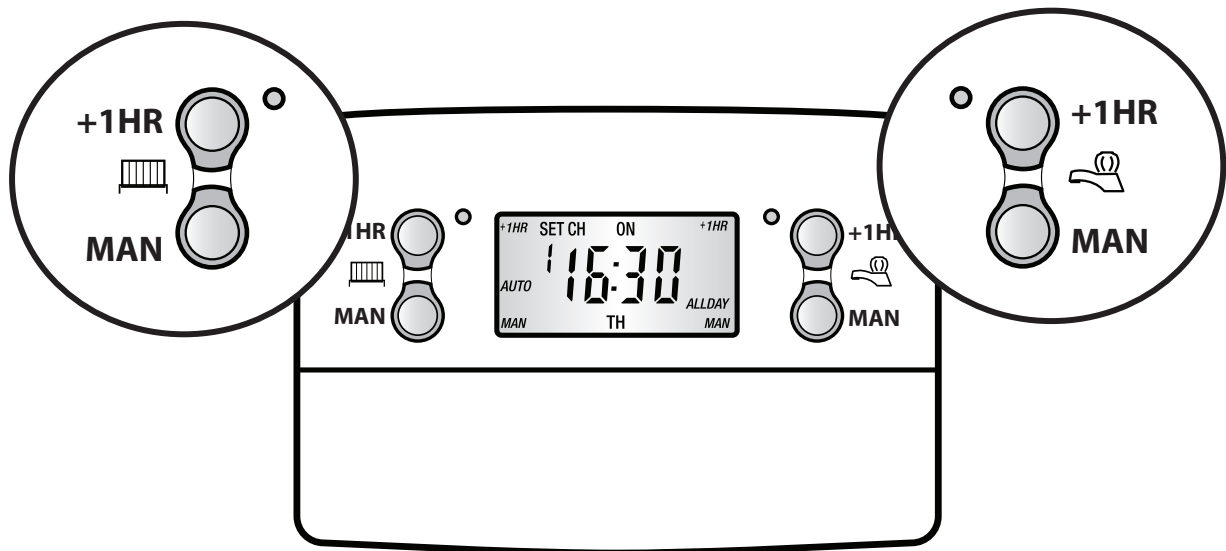

The grey buttons next to the **radiator symbol** are the **Heating** override buttons.



The grey buttons next to the **tap symbol** are the **Hot Water** override buttons.

+1HR

Pressing this button when either system is in **AUTO** or **ALLDAY** mode will cause the heating/hot water to remain on for an extra hour. If it is pressed while the programme is **OFF** the heating/hot water will come on immediately for 1 hour then go off again. **+1HR** will be shown in the display.

MAN

Pressing this button when either system is in **AUTO** or **ALLDAY** mode will cause the heating/hot water to go **OFF** until the next programmed **ON**, or vice versa. **MAN** will be shown in the display.

Holiday Programme

To automatically bring the heating back on when returning from holiday the ESKIT has a built in holiday feature.

Follow the steps below to set the date that the heating system needs to come back on.

1. Press **DAY/HOL**

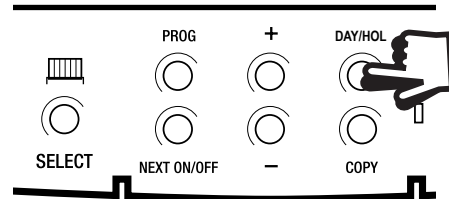

2. Use the + OR - buttons to select the year.

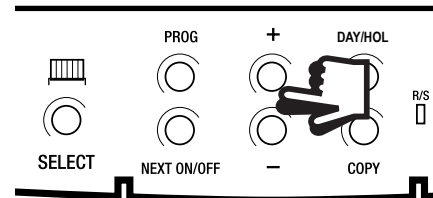

3. Press **DAY/HOL**, then use the + and - buttons to select the month.

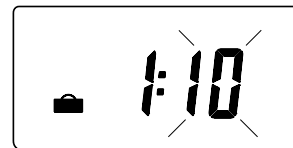

4. Press **DAY/HOL** again, then use the + and - buttons to select the day in month.



5. Press **DAY/HOL** to turn heating off and enter holiday mode.

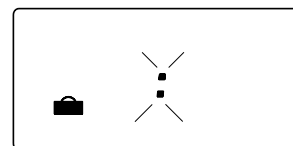

To cancel holiday mode press **DAY/HOL**.

Changing clocks forward & back

This is handled automatically. Should the installer have turned off Automatic Time Change then follow the instructions below.

Open the flap on the front of the unit to reveal the programming buttons.

To change from **Summer to Winter** (clocks back) -

- **press and hold - button**

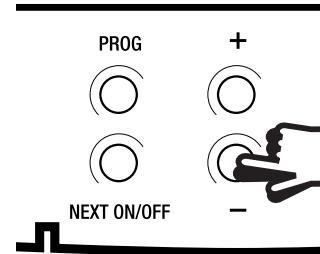

To change from **Winter to Summer** (clocks forward) -

- **press and hold + button**

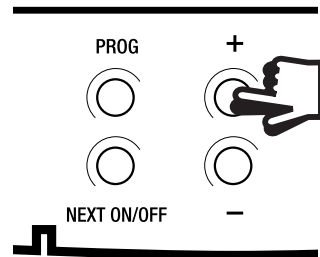

! *Take care when making this change for the first time. If it is made in the wrong direction the unit will have to be reset and any user-settings re-entered*

(see pages 18-19 on how to reset the unit and how to set the date, time and day).

Service Interval Timer

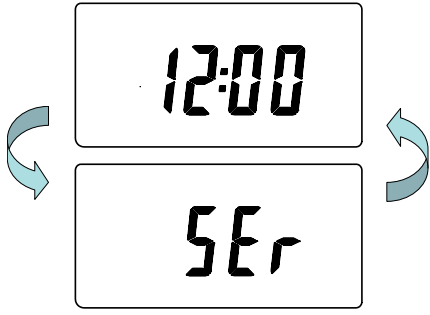
- If the property is owned by a landlord he may, for gas safety reasons, have instructed the installer to set the service interval timer.
- If set, 28 days prior to the boiler service due date, a momentary visual and audible warning will remind you to have the boiler serviced in the next 28 days. This will be repeated each day at noon.A diagram showing a digital display with two lines. The top line shows '12:00' and the bottom line shows '5Er'. Two curved arrows, one on the left and one on the right, point from the top line to the bottom line and from the bottom line to the top line, indicating a cycle or transition between the two states.
- If the boiler is not serviced within 28 days the daily audible warning will sound for 1 minute at the beginning of each hour and must be cancelled each day by pressing any button on the unit.
- In addition, all overrides and programming buttons will be disabled and the heating and hot water will operate for a set portion of each programmed hour.
- The installer will cancel or reset the service interval timer as part of the boiler service.
- This is a gas safety feature that can only be accessed by an installer.
- When the service interval timer is set the service due date can be viewed in RUN mode by pressing and holding the **COPY** button.

Making a Full Reset

If it is necessary to fully reset the unit, excluding the date and time, follow the instructions below.

1. Press and hold the **+1HR** and **MAN** buttons on the left hand side of the product.

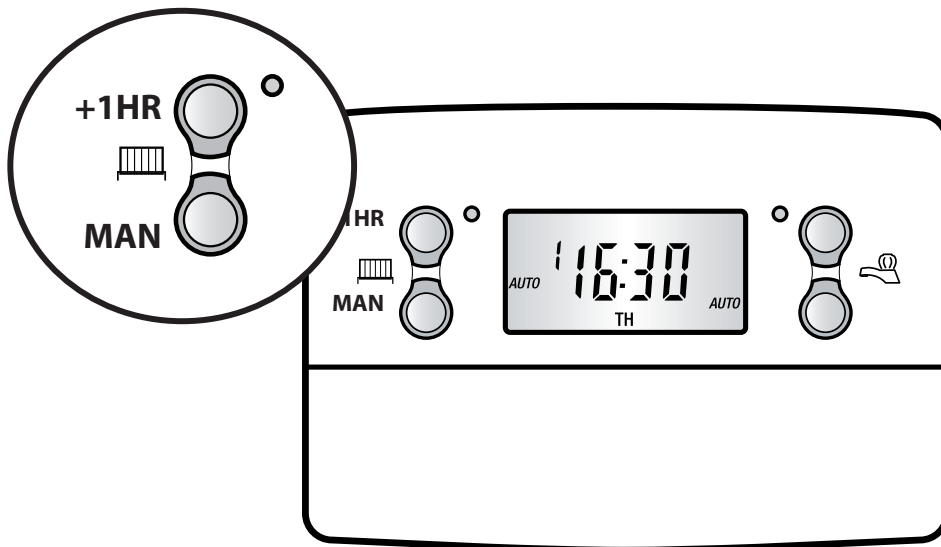

2. Press the **RESET** button and hold for 3 seconds.

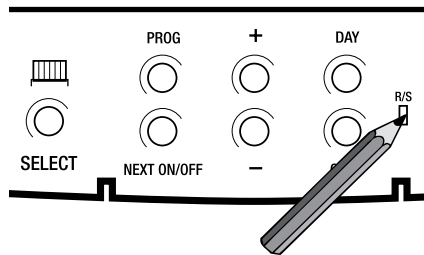

3. Release the **RESET** button. The display will change to show **the current time**.



Example

4. Finally, release both the **+1HR** and **MAN** buttons.

The unit is now fully reset and must be re-programmed, see pages 21-25.

Fault Check List

No Hot Water

Check FP715 programmer. Turn the heating selector to OFF and the water selector to ON.

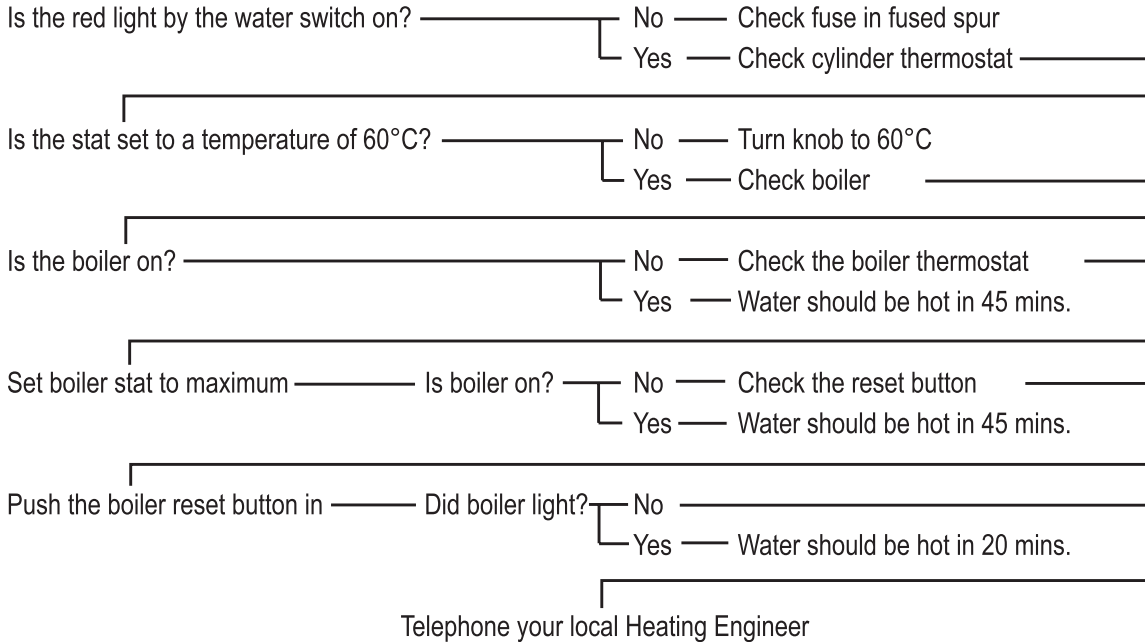

After the water has been heated, return the programmer and other controls to the required settings.

No Heating

Check FP715 programmer. Turn the water selector to OFF and the heating selector to ON.

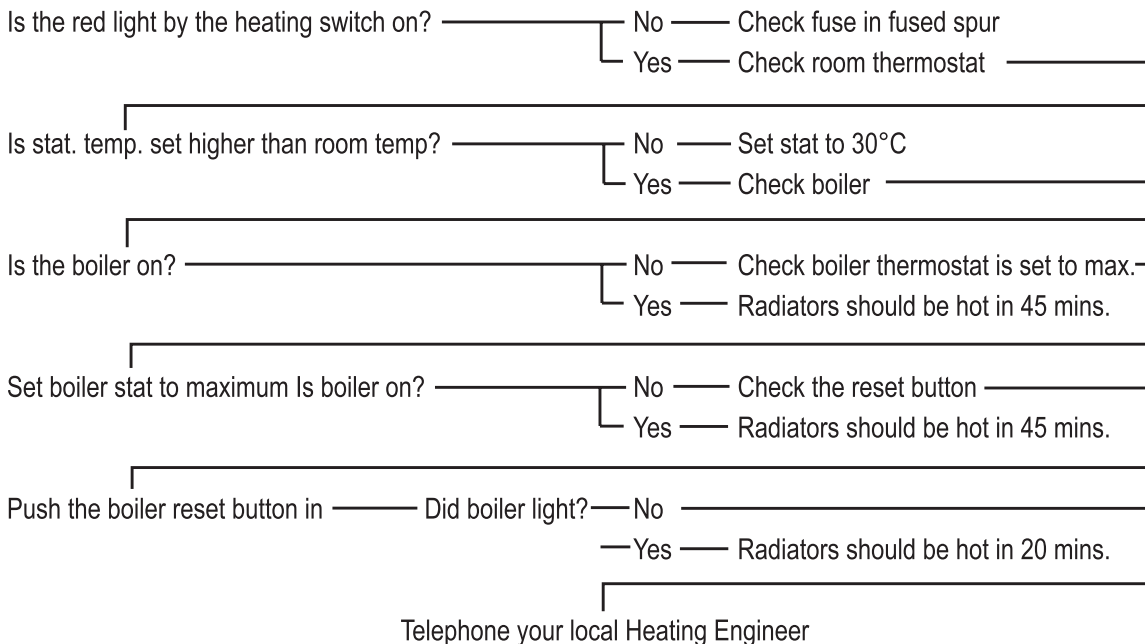

After the heating has come back on, return the programmer and other controls to the required settings.



GRANT ENGINEERING (UK) LTD

Hopton House, Hopton Industrial Estate, Devizes, Wiltshire. SN10 2EU

Telephone: 01380 736920 Fax: 01380 736991

Email: info@grantuk.com Website: www.grantuk.com