

Instructions for Use Installation and Servicing

To be left with the user

Xtrafast

96

G.C. No. 47-047-25

120

G.C. No. 47-047-26

Fanned Flue Combination Boiler



The mark of quality for domestic heating

This is a Cat II_{2H3+} Appliance

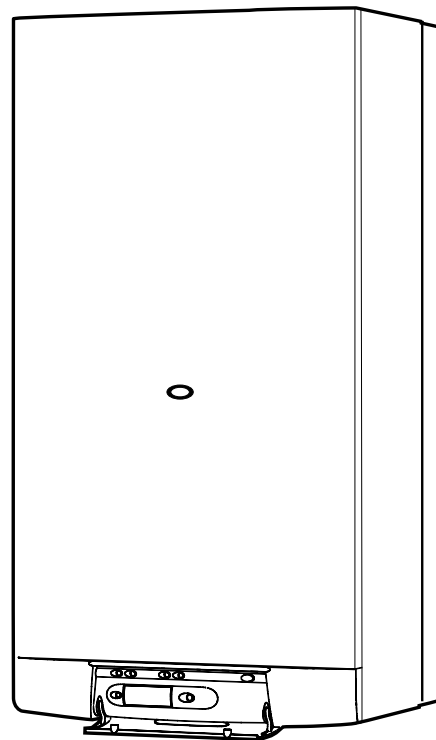

Hab 255a

The instructions consist of three parts, User, Installation and Servicing Instructions, which include the Guarantee Registration Card. The instructions are an integral part of the appliance and must, to comply with the current issue of the Gas Safety (Installation and Use) Regulations, be handed to the user on completion of the installation.

Guarantee Registration

Thank you for installing a new Glow-worm appliance in your home.

Glow-worm appliances' are manufactured to the very highest standard so we are pleased to offer our customers' a Comprehensive First Year Guarantee.

In the centre pages are to be found your Guarantee Registration Card, which we recommend you complete and return as soon as possible.

If this card is missing you can obtain a copy or record your registration by telephoning the Heatcall Customer Service number 01773 828100.

Our Guarantee gives you peace of mind plus valuable protection against breakdown by covering the cost of:

- All replacement parts**
- All labour charges**
- All call-out charges**

REGISTER YOUR GLOW-WORM APPLIANCE
FOR 1ST YEAR GUARANTEE PROTECTION

CALL 0208 247 9857

HEATCALL Customer Services:
Tel: (01773) 828100
One Contact Local Service Fax: (01773) 828070

Hepworth Heating Ltd.,
Nottingham Road, Belper, Derbyshire. DE56 1JT
General/Sales enquiries:
Tel: (01773) 824141 Fax: (01773) 820569

Important Information

Testing and Certification

This boiler is tested and certificated for safety and performance. It is therefore important that no alteration is made to the boiler, without permission, in writing, from Hepworth Heating Ltd.

Any alteration not approved by Hepworth Heating Ltd., could invalidate the certification, boiler warranty and may also infringe the current issue of the Statutory Requirements. The requirements are: The installation of this boiler must be carried out by a competent person in accordance with the current rules in force in the countries of destination at the time of installation. Manufacture's instructions supplied. Manufacture's instructions must not be taken as overriding statutory requirements.

Note: The boiler serial number is marked on the label attached to the inside of the drop down door. Refer to the 'Introduction' section for a description of the basic functions of the boiler. The 'Users' section describes how to safely operate the boiler.

Mandatory warning for CEE countries

Warning: This appliance is designed, approved and inspected to meet the requirements of the market. The identification plate located on the inside of the appliance **certifies the origin** where the product was manufactured and the **country** for which it is intended.

If you see any exception to this rule, please contact your nearest **Glow-worm** dealer.

Thank you in advance for your assistance.

CE Mark

This boiler meets the requirements of Statutory Instrument No. 3083 The boiler (Efficiency) Regulations, and therefore is deemed to meet the requirements of Directive 92/42/EEC on the efficiency requirements for new hot water boilers fired with liquid or gaseous fuels.

Type test for purposes of Regulation 5 certified by: Notified body ****.

Product/production certified by: Notified body ****.

The CE mark on this appliance shows compliance with:

1. Directive 90/396/EEC on the approximation of the laws of the Member States relating to appliances burning gaseous fuels.
2. Directive 73/23/EEC on the harmonization of the Laws of the Member States relating to the electrical equipment designed for use within certain voltage limits.
3. Directive 89/336/EEC on the approximation of the Laws of the Member States relating to electromagnetic compatibility.

Substances Hazardous to Health

The adhesives and sealants used in this appliance are cured and give no known hazard in this state.

INSULATION PADS/CERAMIC FIBRE, GLASSYARN, MINERAL WOOL

These can cause irritation to skin, eyes and the respiratory tract.

If you have a history of skin complaint you may be susceptible to irritation. High dust levels are usual only if the material is broken.

Normal handling should not cause discomfort, but follow normal good hygiene and wash your hands before eating, drinking or going to the lavatory.

If you do suffer irritation to the eyes or severe irritation to the skin seek medical attention.

The insulation is composed of non-combustible material.

Spare Parts

REMEMBER, When replacing a part on this appliance, use only spare parts that you can be assured conform to the safety and performance specification that we require. Do not use reconditioned or copy parts that have not been clearly authorised by Hepworth Heating Ltd.

Contents

CONTENTS	DESCRIPTION	SECTION	PAGE No.
INSTRUCTION FOR USE	Introduction		4
	Controls and Lighting		5
	Clock-timer instructions for use		6
	Draining		6
	Safety Devices		6
	Servicing and Maintenance		7
INSTALLATION INSTRUCTIONS	Technical Data	1	8
	Dimensions	2	9
	Heating System Design	3	9
	Domestic Hot Water System Design	4	10
	Boiler Schematic	5	10
	Boiler Location, Flue and Ventilation	6	11
	Fixing Jig Pack	7	12
	Piping System Installation	8	12
	Boiler Installation	9	14
	Flue Installation	10	14
	Electrical Connection	11	17
	Commissioning	12	18
	Safety Devices	13	22
	Changing Gas Type	14	22
	Settings	15	23
SERVICING INSTRUCTIONS	Routine Cleaning and Inspection	17	24
	Fault Finding	18	27
	Wiring Diagram	19	29
	Replacement of Parts	20	30
	Spare Parts	21	40

Introduction

The **XTRAFAST 96 and 120** boiler is a wall mounted modulating combination boiler with electronic ignition providing central heating and instantaneous hot water. The boiler is equipped with a 4 litre domestic hot water storage vessel that ensures maximum hot water temperature stability during domestic demand.

The boiler is of the **II_{2H3+}** category for use with Natural Gas (G20) as distributed in the United Kingdom.

The boiler has a fan assisted balanced flue which both discharges the products of combustion to and draws the combustion air from the outside of the room.

The boiler is suitable for top outlet flue connection only.

Both the central heating and domestic hot water temperature are user adjustable from the boiler control panel.

Domestic hot water demand always has priority over heating demand.

The boiler is designed for use as part of a sealed water central heating system with fully pumped circulation. The pump, expansion vessel and associated safety devices are all fitted within the boiler.

The boiler can be installed against either an external wall or on an adjacent inside wall, that is, the flue system will pass directly to the rear or to either side to the terminal fitted on the outside wall face.

The installation must be carried out by a competent person in accordance with the relevant requirements of The Building Regulations, The Water Byelaws, The Building Standards (Scotland) Regulations and any applicable local regulations.

These instructions should be carefully followed for the safe and economical use of your boiler.

Electrical Supply

WARNING: This boiler must be earthed.

All system components shall be of an approved type and shall be connected in accordance with the current issue of BS7671 and any applicable local regulations.

All external wiring between the appliance and the electrical supply and earthing requirements shall comply with the current IEE Regulations.

Connection of the boiler and system controls to the mains supply must be through a common isolator and must be fused 3A, maximum. This method of connection must be by a fused double pole isolating switch, with a minimum contact separation

of 3mm on both poles. The switch should be readily accessible and preferably adjacent to the appliance. It should supply the appliance only and be easily identifiable as so doing.

Alternatively, an unswitched shuttered socket outlet and 3A fused 3 pin plug, both to the current issue of BS1363 may be used provided that they are not used in a room containing a bath or shower.

Wiring to the boiler must be PVC 85°C insulated cable, not less than 0.75mm² (24/0.20mm).

Gas safety (Installation and use) Regulations

In your interests and that of gas safety, it is the law that ALL gas appliances are installed and serviced by a qualified registered person in accordance with the above regulations.

Gas leak or fault

If a gas leak or fault exists or is suspected, turn the boiler off and consult the local gas supply company or your installation/service company.

Air in the heating system

Persistent air in the heating system may indicate leaks in the system or corrosion taking place. Call your Installation/Service company.

Overheating safety

In the event of a problem, the overheating safety devices cause safety shutdown of the boiler. If this happens, call your Installation/Service company.

Boiler controls

The control panel, located at the lower front of the boiler casing, **see diagram 1**, allows the boiler to be started, shut down, controlled and monitored during use.

Flue

Do not obstruct the outside terminal of the boiler.

Ancillary equipment

A range of flue accessories are available including vertical flues, twin-pipe flues, bends etc.

For further information contact your supplier.

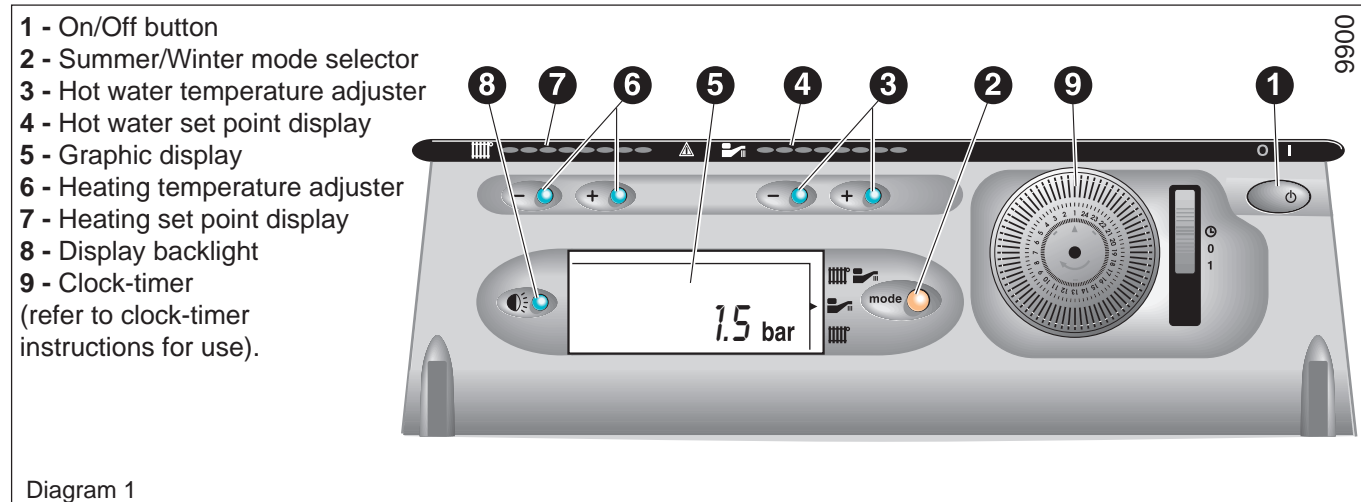

Controls and Lighting

Lighting the boiler :

Make sure that:

- The boiler is connected to the electrical supply.
- The gas service cock is open.

Then follow the instructions below :

A Press the On/Off button (1)

The pressure must be between 1 and 2 bar. If not, the system must be filled by a competent person.

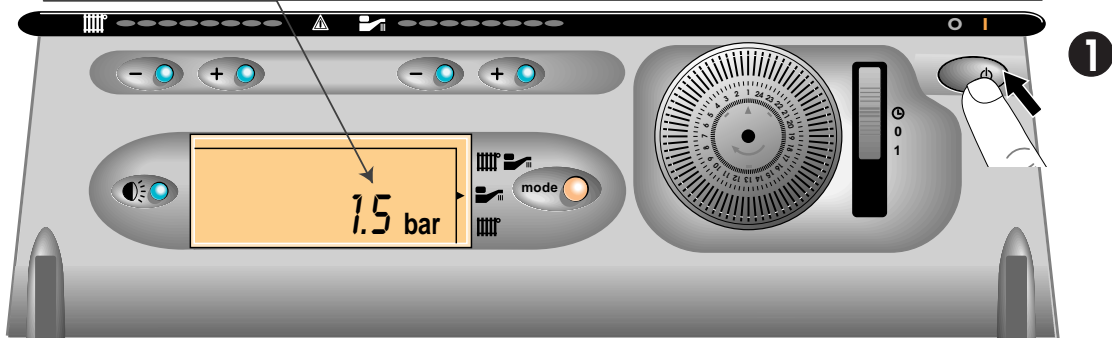

To stop the boiler : Press button (1)

Setting to the SUMMER position (Hot water only)

Press the **mode** button to select the **summer** symbol

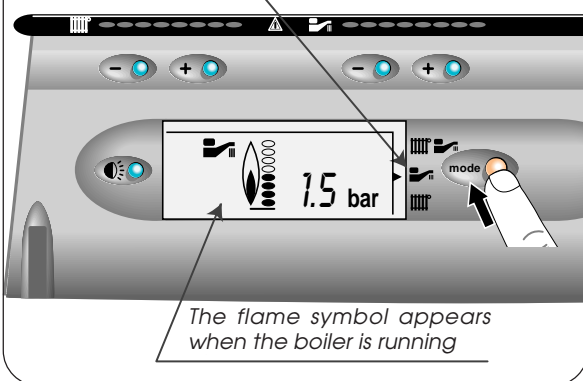

Setting to the WINTER position (Heating + hot water)

Press the **mode** button to select the **winter** symbol

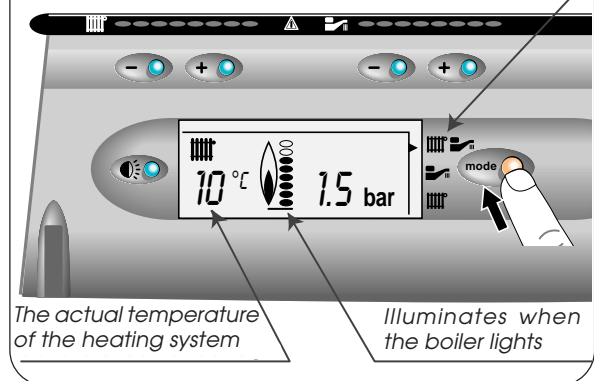

Adjusting the hot water temperature

Press + or - to adjust the maximum temperature of the hot water (38°C to 60°C)

Visual indication of set temperature

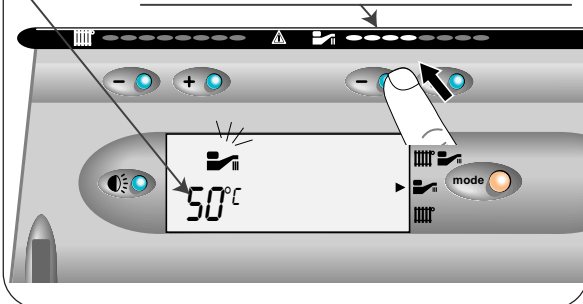

Adjusting the heating temperature

Press + or - to adjust the maximum temperature of the heating (38°C to 87°C)

Visual indication of set temperature

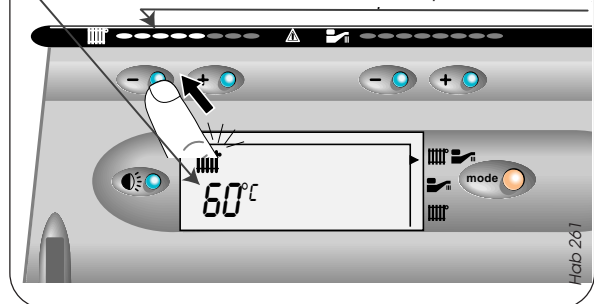

To obtain domestic hot water, open a hot water tap. Hot water always has priority over central heating.

Clock-timer instructions for use

The boiler must be connected to the electrical supply and switched on.

Setting the time

Rotate the clock actuator mechanism clockwise, by hand, until the current time is indicated by the arrow, **see diagram 2**.

Note: The time is set in 24 hour format, for example, 1300 for 1pm.

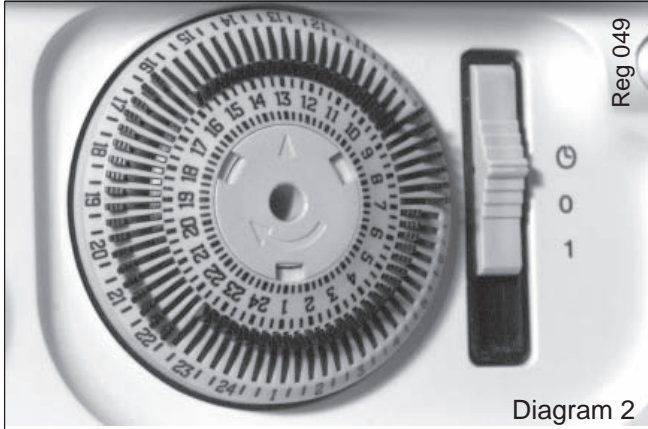

Setting the programme "On" and "Off" times

- Select the "On" times by pushing the white tappets to the outside, **see diagram 2**.
- Select the 'Off' times by pushing the white tappets to the inside, **see diagram 2**.

The clock shown in **diagram 2** is set as follows:

ON - 07.00am to 09.00am (7-9)

OFF - 09.00am to 4.00pm (9-16)

ON - 4.00pm to 10.00pm (16-22)

OFF - 10.00pm to 07.00am (22-7)

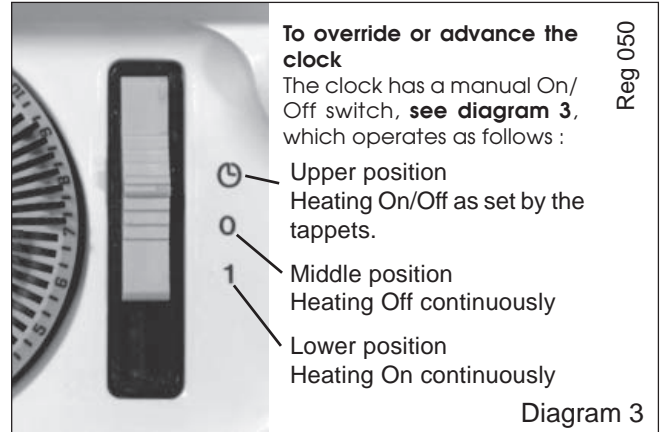

Draining

Protection against freezing

If the boiler is to be out of use for any long periods during severe weather conditions, it is recommended that the whole system, including the boiler, be drained to avoid the risk of freezing.

If in doubt, consult your servicing company.

Draining and filling

Caution: The boiler is installed as part of a sealed system which must only be drained and filled by a competent person.

Safety Devices

Air flow rate safety device

If an obstruction, even partial, of the flue occurs, for any reason, the built in safety system of the boiler will turn the boiler OFF and the fan will continue to run. The boiler will be ready to operate when the fault has been cleared.

Overheat safety

In case of boiler overheating, the overheat thermostat will turn the boiler off. The thermostat, located on the heat exchanger flow pipe, will need to be manually reset. To have this done call a qualified service engineer or Heatcall (Glow-worm's own service organisation) using the telephone number behind the controls cover door or on the front cover of this booklet.

In case of power supply failure

The boiler no longer operates. As soon as power supply is restored, the boiler will be automatically restarted.

Frost protection

The **XTRAFast** has a built in frost protection device that protects the boiler from freezing. If the boiler is to be left and there is a risk of frost, ensure that the gas and electrical supplies

are left connected. The frost protection device will light the boiler when the temperature of the boiler water falls below 6°C. When the temperature reaches 16°C, the boiler stops.

Note : This device works irrespective of any room thermostat setting and will protect the complete heating system.

Heating safety valve

CAUTION: A heating safety valve with a discharge pipe is fitted to this boiler.

The valve **MUST NOT BE TOUCHED** except by a qualified registered person. If the valve discharges at any time, switch the boiler off and isolate it from the electrical supply. Contact your installation/service company.

Pressure relief valve

CAUTION: A domestic hot water pressure relief valve, with a discharge pipe is fitted to this boiler.

The valve **MUST NOT BE TOUCHED** except by a qualified registered person. If the valve discharges at any time, switch the boiler off and isolate it from the electrical supply. Contact a qualified service engineer or Heatcall (Glow-worm's own service organisation) using the telephone number behind the controls cover door or on the front cover of this booklet.

Servicing and Maintenance

To ensure the continued efficient and safe operation of the appliance it is recommended that it is checked and serviced as necessary at regular intervals. The frequency of servicing will depend upon the particular installation conditions and usage, but in general once a year should be enough.

If this appliance is installed in a rented property there is a duty of care imposed on the owner of the property by the current issue of the Gas Safety (Installation and Use) Regulations, Section 35.

Servicing/maintenance should be carried out by a competent person in accordance with the rules in force in the countries of destination.

To obtain service, please call your installer or Heatcall (Glow-worm's own service organisation) using the telephone number behind the controls cover door.

Please be advised that the 'Benchmark' logbook should be completed by the installation engineer on completion of commissioning and servicing.

All CORGI Registered Installers carry a CORGI ID card, and have a registration number. Both should be recorded in your boiler Logbook. You can check your installer is CORGI registered by calling CORGI direct on: 01256 372300.

Cleaning

WARNING: This appliance contains metal parts (components) and care should be taken when handling and cleaning with particular regard to edges of sheet metal parts to avoid any possibility of personal injury.

The boiler casing can be cleaned using a mild liquid detergent with a damp cloth, followed by a dry cloth to polish.

Do not use any form of abrasive or solvent cleaner as you may damage the paint work.

Boiler casing

CAUTION. Do not remove or adjust the casing in any way, as incorrect fitting may result in faulty operation. If in doubt, consult your installation/service company.

1 Technical Data

	XTRAFast 96	XTRAFast 120
Heating		
Heating output adjustable from ... (kW)	10,4	11,7
to ... (kW)	27,6	34,6
from ... (BTU/H)	35,485	39,920
to ... (BTU/H)	94,170	118,053
Efficiency (%)	**	**
Maximum heating temperature (°C)	87	87
Expansion vessel effective capacity (l)	7	12
Expansion vessel charge pressure (bar)	0,5	0,5
Maximum system capacity at 75°C (l)	160	275
Safety valve,		
maximum service pressure (bar)	3	3
Products outlet diameter (mm)	60	60
Fresh air inlet diameter (mm)	100	100

Hot water

	XTRAFast 96	XTRAFast 120
Hot water output		
automatically variable from ... (kW)	10,4	11,7
to ... (kW)	27,6	34,6
from ... (BTU/H)	35,485	39,920
to ... (BTU/H)	94,170	118,053
Maximum hot water temperature (°C)	60	60
Specific flow rate (for 30°C temp rise)		
(l/min.)	13,2	16,5
Threshold flow rate (l/min.)	1	1
Nominal water flow rate (l/min.)	11,3	16,5
Maximum supply pressure (bar)	8	8
Minimum operating pressure (bar)	0,7	0,7

	XTRAFast 96	XTRAFast 120
Natural Gas (G20)		
Ø Burner injector (mm)	1,20	1,20
Inlet pressure (mbar)	20	20
Burner pressure (mbar)	13,8	14,1
Gas rate maximum (m³/h)	3,20	3,98
Gas rate minimum (m³/h)	1,32	1,48

	XTRAFast 96	XTRAFast 120
Electrical supply (V)	230	230
Maximum absorbed power (W)	220	220
Level of protection	IP44	IP44
Fuse rating	125mAT	125mAT

	Xtrafast 96	Xtrafast 120
Lift weight	51.2kg (112.9lb)	**.*kg (**.*lb)
Total weight (inclusive water)	**.*kg (**.*lb)	**.*kg (**.*lb)

The Seasonal Efficiency Domestic Boilers UK (SEDBUK) is **.*%.

The value is used in the UK Government's Standard Assessment Procedure (SAP) for energy rating of dwellings. The test data from which it has been calculated have been certified by B.S.I.

1 Technical Data

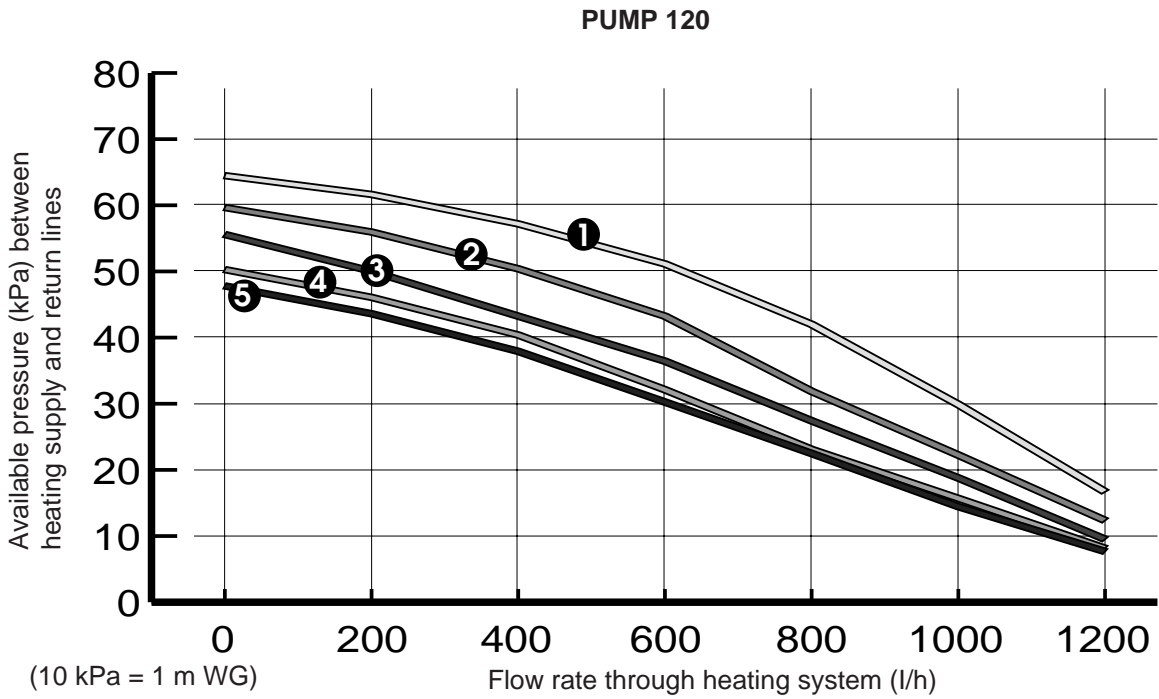
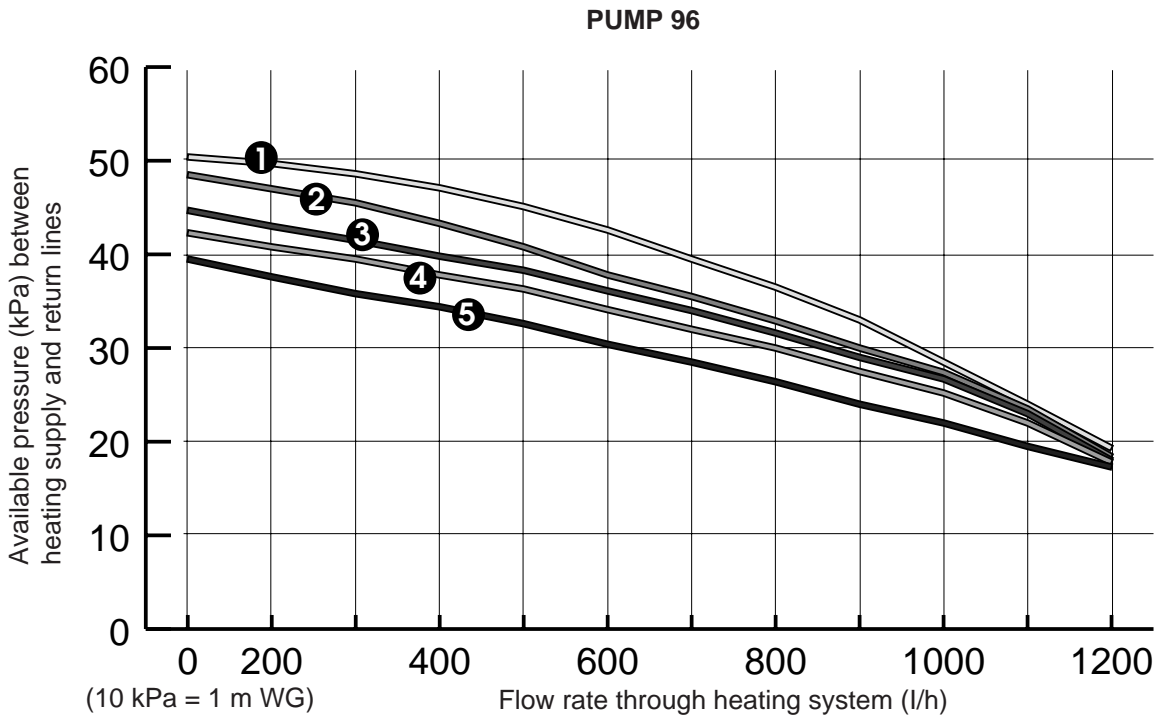

- 1** Bypass fully shut
- 2** Open 1/4 turn
- 3** Open 1/2 turn
- 4** Open 1 turn
- 5** Open 2 turns

Diagram 4

2 Dimensions

7422

The **XTRAFast** is delivered in three separate packages:

- the boiler
- the fixing jig
- the flue system

Lifting Weight:
51,2 kg

X = 470 (96)
552 (120)

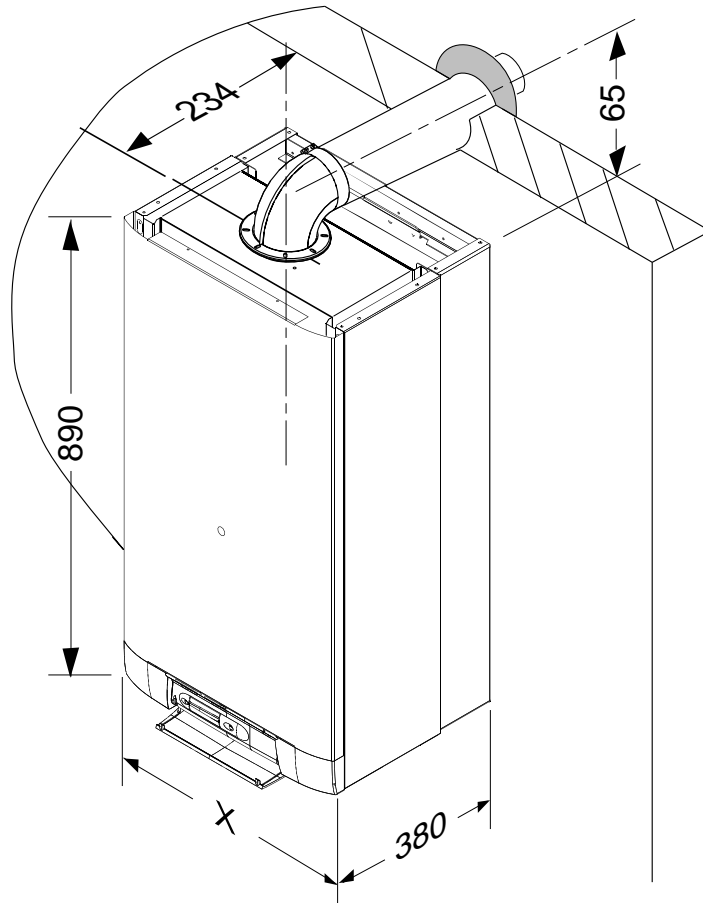

Diagram 5

3 Heating System Design

- The **XTRAFast** is compatible with any type of installation.
- Heating surfaces may consist of radiators, convectors or fan assisted convectors.
- The **XTRAFast** can be piped directly to an underfloor heating system without the need for a mixing bottle. The maximum central heating flow temperature can be set to 53°C on the boiler printed circuit board during commissioning.
- Pipe sectional areas shall be determined in accordance with normal practices, using the output/pressure curve (**diagram 4**). The distribution system shall be calculated in accordance with the output requirements of the actual system, not the maximum output of the boiler. However, provision shall be made to ensure sufficient flow so that the temperature difference between the flow and return pipes be less than or equal to 20°C. The minimum flow is 400 l/h.
- The piping system shall be routed so as to avoid any air pockets and facilitate permanent venting of the installation. Bleed fittings must be provided at every high point of the system and on all radiators.
- The total volume of water permitted for the heating system depends, amongst other things, on the static head in the cold condition. The expansion vessel on the boiler is pressurised at 0,5 bar (corresponding to a static head of 5 m w.g.) and allows a maximum system volume of 160 litres for an average temperature of 75°C and a maximum service pressure of 3 bar. This pressure setting can be modified at commissioning stage if the static head differs. An additional expansion vessel can be fitted to the system if required, **see diagram 8.2**.
- Provision shall be made for a drain valve at the lowest point of the system.
- Where thermostatic radiator valves are fitted, not all radiators must be fitted with this type of valve, and in particular, where the room thermostat is installed.
- In the case of an existing installation, it is **ESSENTIAL** that the system is thoroughly flushed prior to installing the new boiler.

Filling the system

A filling device must be provided to fill the system, **see diagram 8.2**.

4 Domestic Hot Water System Design

- Copper tubing or plastic hep₂o may be used for the domestic hot water system. Unnecessary pressure losses should be avoided.
- A flow restrictor limiting the flow through the boiler to a maximum of 12 l/min is fitted to the boiler.
- The boiler will operate with a minimum supply pressure of 0,7

bar, but under reduced flow rate. Best operating comfort will be obtained from a supply pressure of 1 bar.

'Hard Water Areas'

In areas where the water is 'hard', more than 200mg/litre, it is recommended that a proprietary scale reducer is fitted in the cold water supply to the boiler.

5 Boiler Schematic

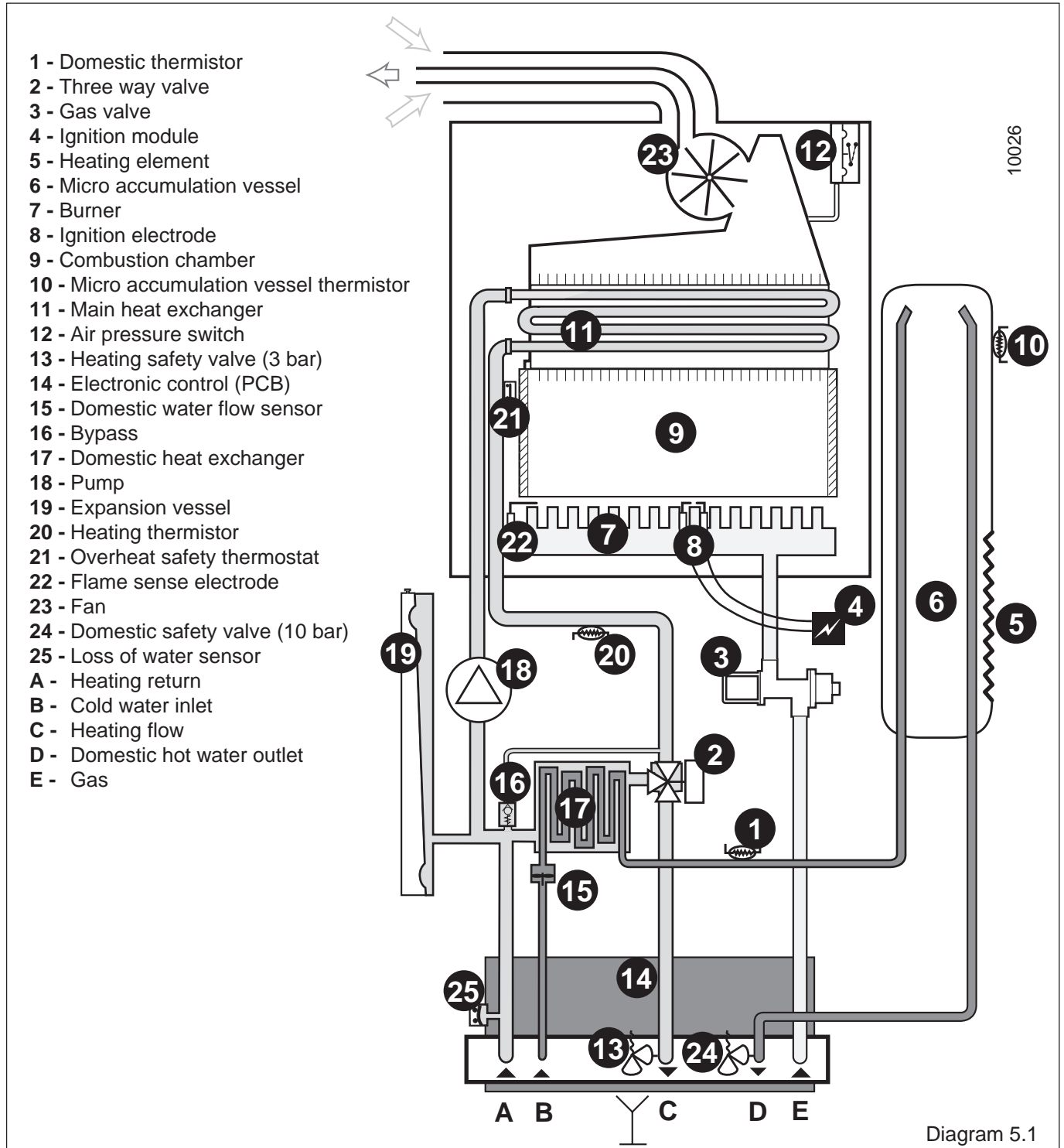

6 Boiler Location, Flue and Ventilation

If the appliance has to be stored for any length of time before installation it should be kept in a safe place where it will not be a hazard to persons or obstruct any access. Care should be taken when handling or moving the appliance taking note of the trucking points on the sides of the carton.

6.1 Clearances

The position of the boiler must be such that there is adequate space for servicing.

The recommended clearances are:

20 mm either side of the boiler.

600 mm at the front of the boiler.

300 mm below the boiler.

25 mm above the flue elbow.

Note: The boiler must be mounted on a flat wall which is sufficiently robust to take its weight when full, that is, ** kg. If in doubt, expert advice should be obtained. In the event of the wall being found not suitable.

Note: It is permissible to install the boiler with smaller clearances than those quoted above PROVIDING that adequate consideration is given for Servicing/Repairs at a later date. If any doubt exists, contact the **Glow-worm Technical Helpline 01773 828100**.

The minimum acceptable spacings from the terminal to obstructions and ventilation openings are shown in **diagram 6.1**.

The boiler must be installed so that the terminal is exposed to the external air.

Should any doubt exist as to the permissible position of the terminal, contact the **Glow-worm Technical Helpline 01773 828100**.

6.2 Terminal guard

A terminal guard is required if persons could come into contact with the terminal or the terminal could be subject to damage.

If a terminal guard is required, it must be positioned to provide a minimum of 50mm clearance from any part of the terminal and to be central over the terminal.

Terminal guard type K3 supplied by:

Tower flue components Ltd.
Morley road
Tonbridge
Kent
TN9 1RA

6.3 Flue options

There are various flue systems to choose from as follows:

Standard horizontal flue pack.

Standard horizontal extended flue pack.

Vertical flue pack.

Twin flue pack.

Extensions, 90° and 45° bends.

Flue options and accessories.

For detailed information refer to flue guide Part No. 223278.

6.4 Cupboard or compartment ventilation

The boiler can be fitted in a cupboard or compartment without the need for permanent ventilation.

MINIMUM SITING DIMENSIONS FOR THE POSITIONING OF FLUE TERMINALS MM

A	DIRECTLY BELOW, ABOVE OR HORIZONTALLY TO AN OPENING, AIR BRICK, OPENING WINDOWS, AIR VENT, OR ANY OTHER VENTILATION OPENING	300
B	BELOW GUTTER, DRAIN/SOIL PIPE	75
C	BELOW EAVES	200
D	BELOW A BALCONY OR CAR PORT	300
E	FROM VERTICAL DRAIN PIPES AND SOIL PIPES	300
F	FROM INTERNAL CORNERS AND EXTERNAL CORNERS	300
G	ABOVE ADJACENT GROUND OR BALCONY LEVEL	300
H	FROM SURFACE FACING THE TERMINAL	600
I	FACING TERMINALS	1200
J	FROM OPENING (DOOR/WINDOW) IN CAR PORT INTO DWELLING	1200
K	VERTICAL FROM A TERMINAL	1500
L	HORIZONTALLY FROM A TERMINAL	600

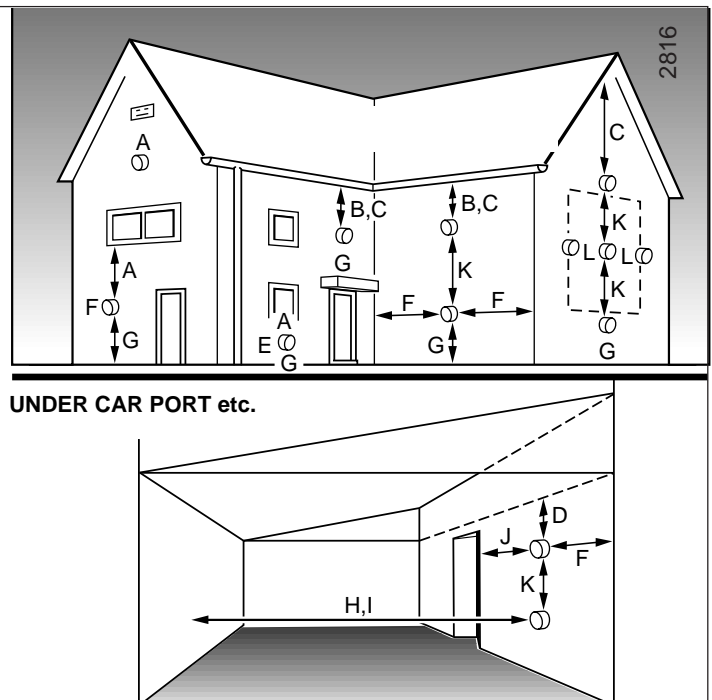

Diagram 6.1

7 Fixing Jig Pack

The fixing jig is made up, from left to right, as follows:

- A** - Heating return fitting with isolating valve(v) and drain knob (u).
- B** - Cold water inlet fitting with isolating valve (m) and factory fitted flow regulator and filter (not shown).
- C** - Heating flow fitting with isolating valve (q), drain knob (r) and safety valve (s1).
- D** - Domestic hot water outlet fitting with safety valve (s2).
- E** - Gas fitting.

Other components within the fixing jig pack.

- F** - Hanging bracket
- G** - wall template
- H** - copper connections
- J** - sealing washers
- K** - sealant (putty)

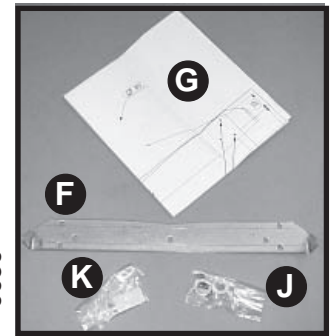

9959

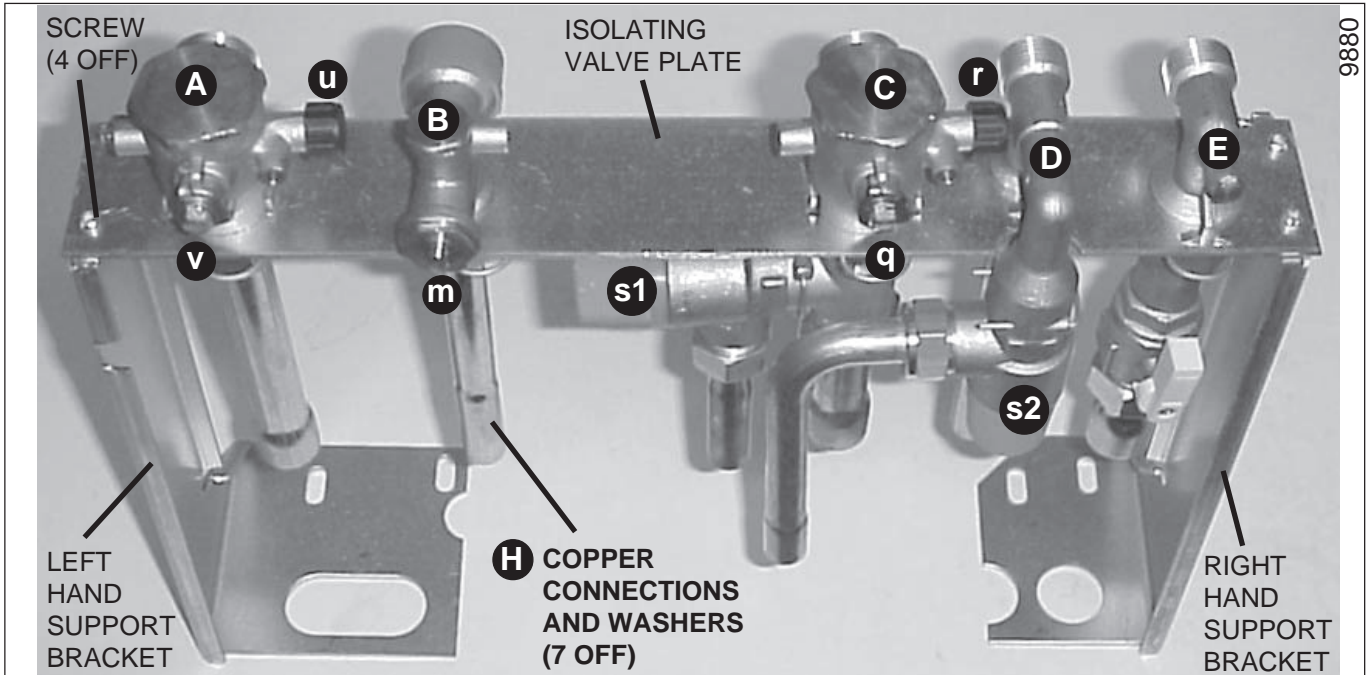

9880

THE FIXING JIG SHOWN ASSEMBLED

Diagram 7.1

8 Piping System Installation

8.1 Fixing jig

- Remove the contents of the fixing jig pack.
- Secure the left and right hand support brackets to the isolating valve plate with the securing screws (4 OFF) supplied, **see diagram 7.1**.
- Connect the six copper connections and sealing washers to the isolating valves, **see diagram 7.1**.
- Heating system connections - Pipe diam. 22mm
- Hot water system connections - Pipe diam. 15mm
- Gas connection - Pipe diam. 22mm
- Domestic safety valve connection - Pipe diam. 15mm
- Heating safety valve connection - Pipe diam. 15mm

8.2 Wall template

- Remove the wall template, follow the instructions given on the wall template.
- Note: It is important the hanging bracket and service cock

bracket are fitted to a flat and true wall area for correct alignment with the boiler. If this cannot be achieved it is acceptable to pack out the service cock bracket to obtain the correct alignment.

- Position the wall template, **see diagram 8.1**.
- Mark the position of the holes for the hanging bracket and jig.
- Drill, plug and fix the hanging bracket to the wall using suitable screws.
- Check that the hanging bracket is level.
- Drill plug and fix the fixing jig to the wall.
- For horizontal flue system, mark the position for the flue hole as follows:

8.3 Flue to rear of boiler

- Mark correct position of hole from template.

8.4 Flue to side of boiler

- Mark the horizontal centre line for the hole on the rear wall. Extend the horizontal centre line to the side wall and mark the vertical centre line of flue hole as shown in **diagram 8.1**.

8 Piping System Installation

8.5 Cutting the flue hole

- Making allowance for the slope of the flue, cut hole in external wall, preferably using a core drill. For installations with internal and external access use a 105 mm diameter core drill.

For installations with internal access only use a 125 mm diameter core drill.

8.6 Important

When cutting the flue hole and when extending the flue centre line to a side wall, remember that the flue system must have a fall of about 35 mm per metre of flue **DOWNWARD** towards the terminal. There must **NEVER** be a downward incline towards the boiler.

8.6 Terminal position

The minimum acceptable spacings from the terminal to obstructions and ventilation openings are shown in **diagram 6.1**.

The boiler must be installed so that the terminal is exposed to the external air.

Should any doubt exist as to the permissible position of the terminal, contact the **Glow-worm Technical Helpline 01773 828100**.

8.7 Water connection

Connect the system pipework to the copper connections on the fixing jig observing the correct flow and return format as shown in **diagram 8.2**. Do not subject the isolating valves to heat.

8.8 Heating safety valve and domestic safety valve discharge, refer to diagram 8.3.

Tee the domestic safety valve outlet pipe to the heating safety valve outlet pipe and extend horizontally to the outside wall.

WARNING. It must not discharge above an entrance or window or any type of public access area.

Connect the safety valve discharge pipe to the outlets of both the heating safety valve and the domestic water safety valve, the discharge must be extended using not less than 15mm. pipe, to discharge in a visible position outside the building, facing downward preferably over a drain.

The pipe must have a continuous fall and be routed to a position so that any discharge of water, possibly boiling or steam, cannot create any danger to persons, damage to property or external electrical components and wiring. Tighten all pipe connection joints.

8.9 Gas connection

- The supply from the governed gas meter must be of adequate size to provide a constant inlet working pressure of 20 mbar (8 in w.g.).

To avoid low gas pressure problems, it is recommended that the gas supply is connected using 22 mm pipe.

- On completion, the gas installation must be tested using the pressure drop method and purged in accordance with the current issue of BS6891.

8.10 Gas Safety (Installation and use) Regulations

In your interests and that of gas safety, it is the law that **ALL** gas appliances are installed and serviced by a competent person in accordance with the above regulations.

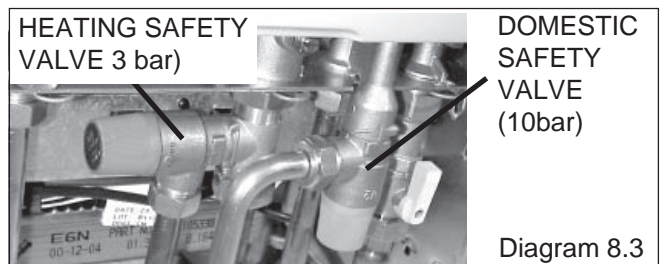
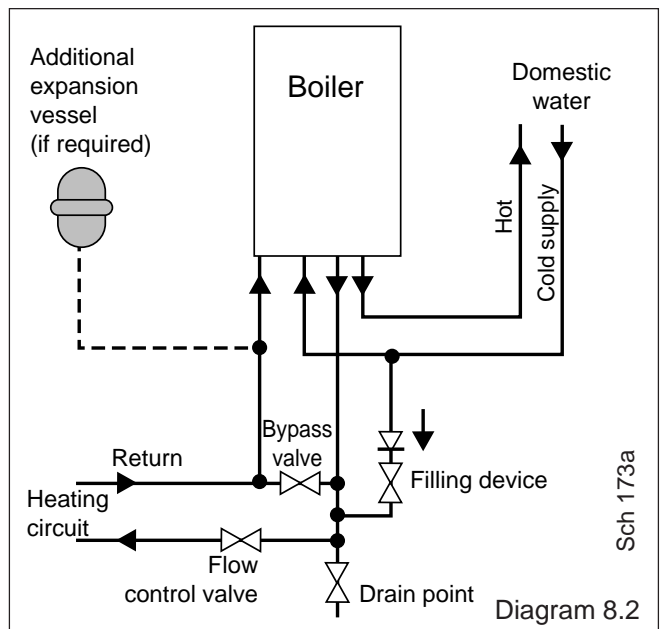
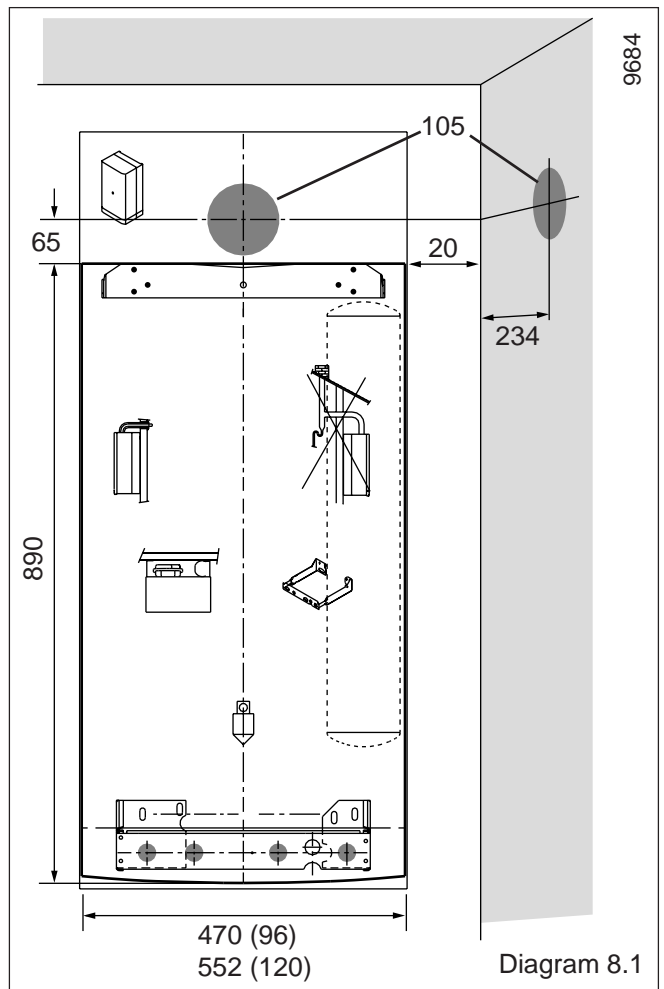

9 Boiler installation

9.1 Statutory requirements

The installation of this boiler must be carried out by a qualified registered person in accordance with the relevant requirements of the current issue of:

The Gas Safety (Installation and Use) Regulations

The Building Regulations

The local water company Byelaws

The Building Standards Regulations (Scotland)

The Health and Safety at Work Act

9.2 Sheet metal parts

WARNING. When installing or servicing this boiler, care should be taken when handling the edges of sheet metal parts to avoid the possibility of personal injury.

9.3 Installing the boiler

Prior to starting work, the system must be thoroughly flushed using a propriety cleanser such as **Sentinel X300** to eliminate any foreign matter and contamination e.g. metal filings, solder particles, oil, grease etc.

Note. Solvent products could cause damage to the system.

The boiler pack consists of the boiler, base panel, literature, sealing washers and securing screws.

- Lay boiler on its back.
- Remove all packaging from around the boiler.
- Remove front panel, put in a safe place to avoid damaging it.
- Ensure the plastic plugs are removed from water and gas pipes. **NOTE:** There will be some spillage of water.
- Remove transportation timber support bar from bottom rear of boiler.
- If required the boiler can be stood upright supported by extending the legs at the front bottom of the boiler.
- Engage boiler upper part onto the hanging bracket.
- Fit the washers between the boiler pipes and the inlet and outlet fittings on the fixing jig and connect the various couplings between the boiler and jig.
- Fit the base panel, hook in at the rear secure with the four self tapping securing screws at the front.

10 Flue Installation

10.1 Top outlet flue - kit 86285

The boiler is only suitable for top outlet flue connection.

10.2 Rear flue systems

(Refer to diagram 10.1). To calculate the length when flueing to the rear measure wall thickness **e** plus 160 mm for the outer air duct and **e** plus 244 mm for the inner flue duct measurement.

10.3 Flue systems Right or Left

(Refer to diagram 10.1). To calculate the length when flueing to the side measure wall thickness **e** plus inside of wall to side of boiler **a** add 145(mm) for the outer air duct and wall thickness **e** plus inside of wall to side of boiler **a** add 229(mm) for the inner flue duct measurement.

• Refer to diagram 10.2 (Table A) for cutting lengths of both flue duct and air duct pipes for each of the various flue options available.

Important: All flue cutting lengths must be measured from the terminal end of the flue pipes, see diagram 10.2 (D).

When the dimension **X** measured on site is greater than that given in diagram 10.2 (Table B), extensions will be required as necessary.

Calculation of flue cutting lengths for extended flue

•Using the correct number of extension kits as (Table B), measure dimensions **a** and **e**, see diagram 10.1. Cut both the flue duct and air duct pipes to the dimensions given in (Table C)

Important: All cutting lengths should be measured from the push fit joint end of the extension pipe. Do not leave any burrs or sharp edges on the cut ends of the pipes. **Note :** maximum horizontal flue length without bends is 3.5m.

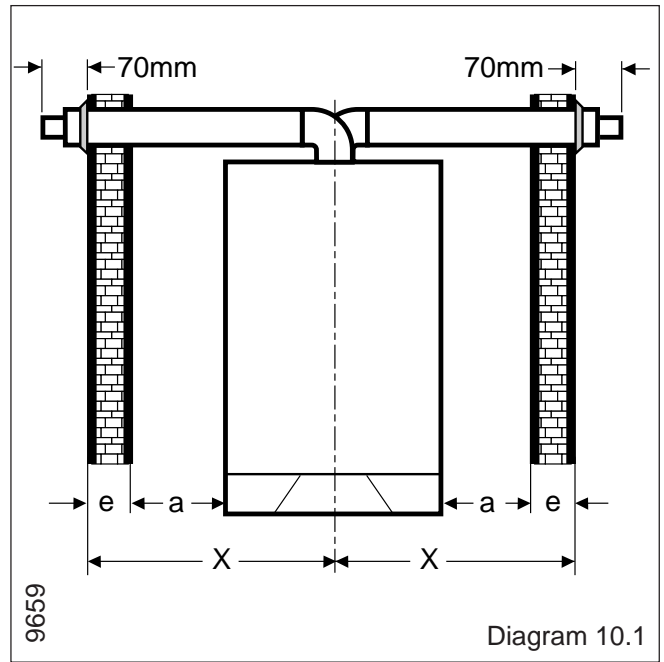

Diagram 10.1

Table A: Flue cutting lengths (mm)

Rear flue
 Air Duct pipe : $e + 160$, Flue duct pipe : $e + 244$
Note : maximum distance 'x' without extension 756 mm

Side flue (right or left)
 Air Duct pipe : $e + a + 145$, Flue duct pipe : $e + a + 229$
Note : maximum distance 'x' without extension 990 mm

Table B: Number of extension kits required

Flue option	Dimension 'X'	No. of extension kits
Side flue	991 to 1991 mm	1
(left or right)	1991 to 2991 mm	2

Note: Maximum flue length for 120 model is 2 metres

Table C: Flue extension cutting lengths (mm)

Rear flue option
 Air Duct pipe : $e + a - 755$, Flue duct pipe : $e + a - 755$
Note : maximum distance 'x' without extension 990 mm

(D)

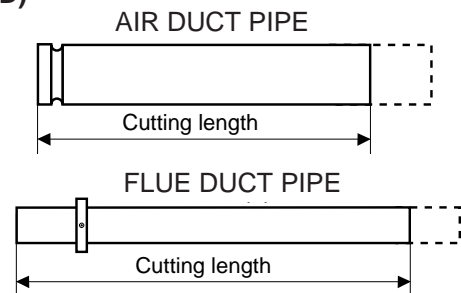

Diagram 10.2

10 Flue Installation

10.4 Installation of flue assembly

- Fit rubber sealing collar (F), see diagram 10.3, into groove at the outer end of pipe (A).
- Fit air duct pipe (A) into wall with groove to the outside.
- Pull pipe inwards to bring rubber sealing collar hard up against external wall, see diagram 10.4.
- Fit internal plastic flange (G) onto air duct pipe. Push along the pipe until engaged against internal wall.
- From inside, insert flue duct pipe (B) into air duct pipe.
- Fit both 'O' rings (J) into the flue elbow (C), one at the inlet, one at the outlet. By necessity, they are a loose fit, apply a small amount of silicone grease to each 'O' ring when fitting.
- Fixing collar (D) over air duct pipe (A) and elbow (C) ensuring it is the correct way round (Note: the fixing collar can only be fitted one way due to different diameters of the flue elbow and air duct).
- Take hold of the flue duct pipe and push gently onto the elbow taking care not to tear the 'O' ring.
- Open fixing collar (D) and locate between elbow and air duct pipe (A). Close fixing jig.
- Engage the two fixing clips (E) onto the collar (D) and press down to lock into position. Secure clips with screws provided.

Important: If the flue has been cut, ensure that there are no burrs that could damage the 'O' ring.

- For flue systems less than 1,5 m long, leave the restrictor (a) fitted in the fan outlet, see diagram 10.5.
- Remove the backing from the self adhesive gasket (H) and carefully fit gasket to base of flue elbow.
- Fit elbow onto boiler and secure with the four screws (I).

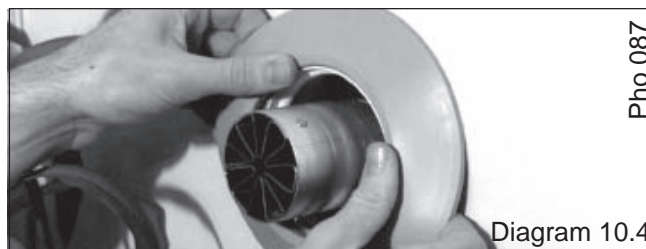
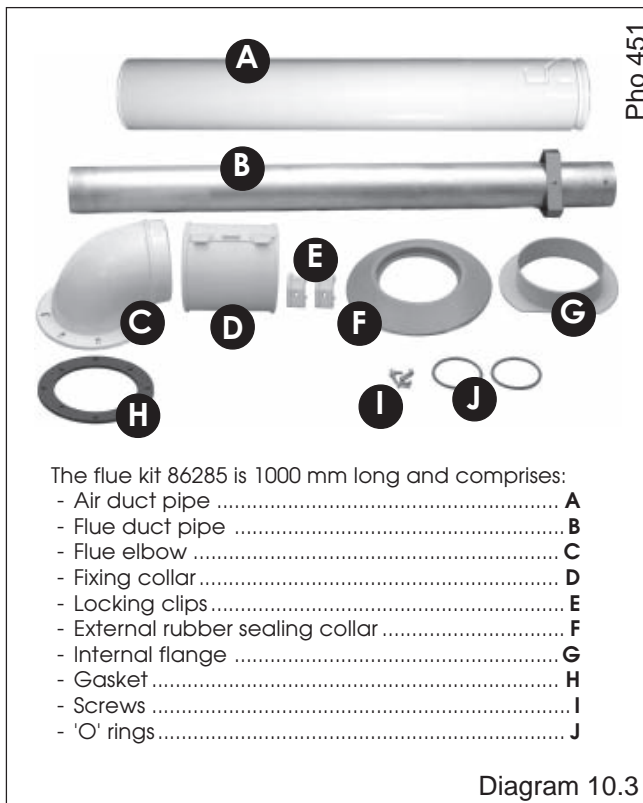

Concentric flue system

The maximum permissible length (L) for the concentric flue system is 3.5 m. For flue systems up to 1,5 m length, the restrictor (a) supplied fitted to the boiler, inside the fan outlet, must be left in place. For longer flue systems, the restrictor must be removed. For each 90° flue elbow used, (or two 45° elbows) the maximum permissible length (L) must be reduced by 1 metre.

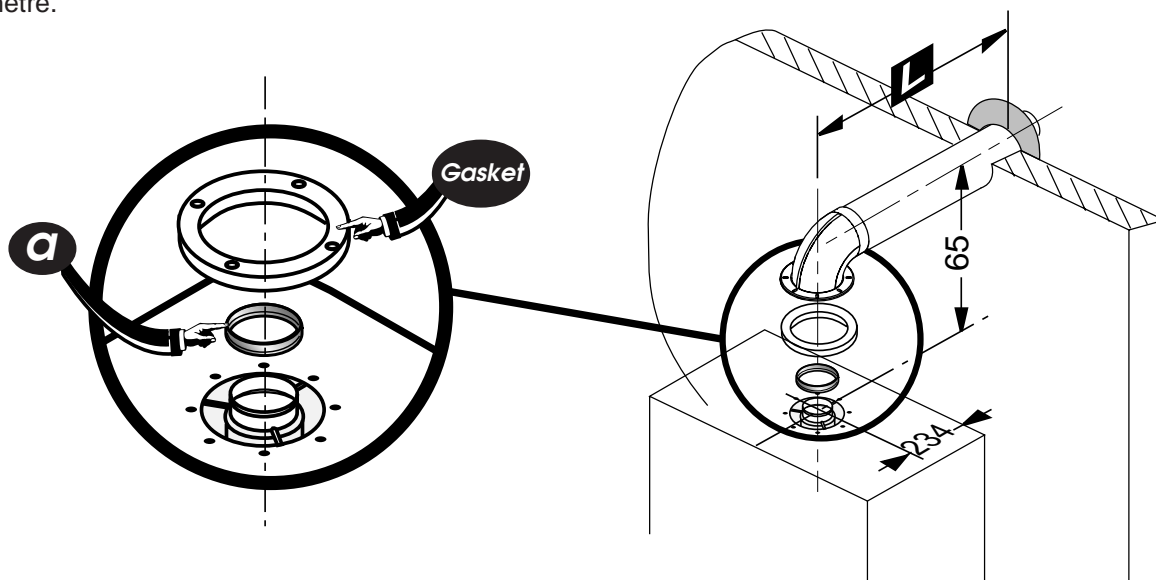

11 Electrical Connection

Warning. This boiler must be earthed

The boiler is supplied with a mains lead attached. Standard colours are Brown - Live, Blue - Neutral, Green and Yellow - Earth.

All system components must be of an approved type.

Electrical components have been tested to meet the equivalent requirements of the BEAB.

Connection of the whole electrical system and any heating system controls to the electrical supply must be through a common isolator.

Isolation should preferably be by a double pole switched fused spur box having a minimum contact separation of 3 mm on each pole. The fused spur box should be readily accessible and preferably adjacent to the boiler. It should be identified as to its use.

A fused three pin plug and shuttered socket outlet may be used instead of a fused spur box provided that:

- a) They are not used in a room containing a fixed bath or shower.
- b) Both the plug and socket comply with the current issue of BS1363.

The mains electrical supply must be maintained at all times in order to provide domestic hot water.

Do not interrupt the mains supply with a time switch or programmer.

WARNING: ON NO ACCOUNT MUST ANY EXTERNAL VOLTAGE BE APPLIED TO ANY OF THE TERMINALS ON THE HEATING CONTROLS CONNECTION PLUG.

Warning: This appliance must be wired in accordance with these instructions. Any fault arising from incorrect wiring cannot be put right under the terms of the **Glow-worm** guarantee.

11.1 External controls

The **XTRAFast** boiler is designed to operate at maximum efficiency at all times, but will be most efficient and economical when connected to a room thermostat.

To gain access to the external control connections, unclip side clips and hinge up control panel cover, see **diagram 11.2**.

The boiler will work for heating without a room thermostat being connected provided that the wire link fitted between the two terminals of the connector (**E**) is left in place, see **diagram 11.3**.

Alternatively, a 230V room thermostat can be used but do not make any connection to the compensating resistor, see **diagram 11.3**.

ON NO ACCOUNT must any electrical voltage be applied to any of the terminals of the external controls plug.

Remote Control

A remote control is available for the Xtrafast. Part no. xxxxxx. If the remote control is fitted the wire link must be in place on connector (**E**), and the Switch **SW3** must be adjusted, see **diagram 11.4**.

11.2 Electrical test

Carry out preliminary electrical system checks as below:

1. Test insulation resistance to earth of mains cables.
2. Test earth continuity and short circuit of all cables.
3. Test the polarity of the mains.

Note: For further information, see the building regulations 1991 - Conservation of Fuel and Power - 1995 edition - appendix G, Table 4b.

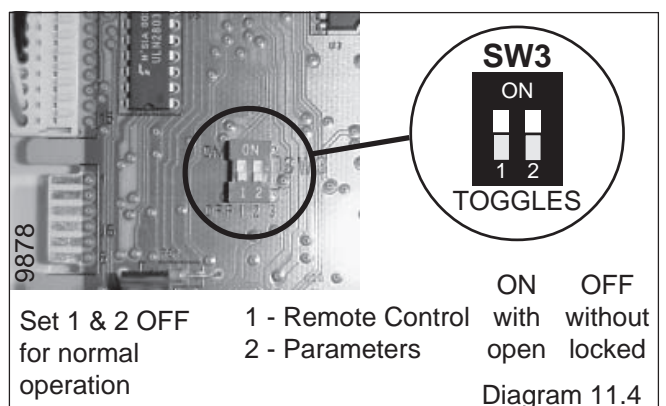
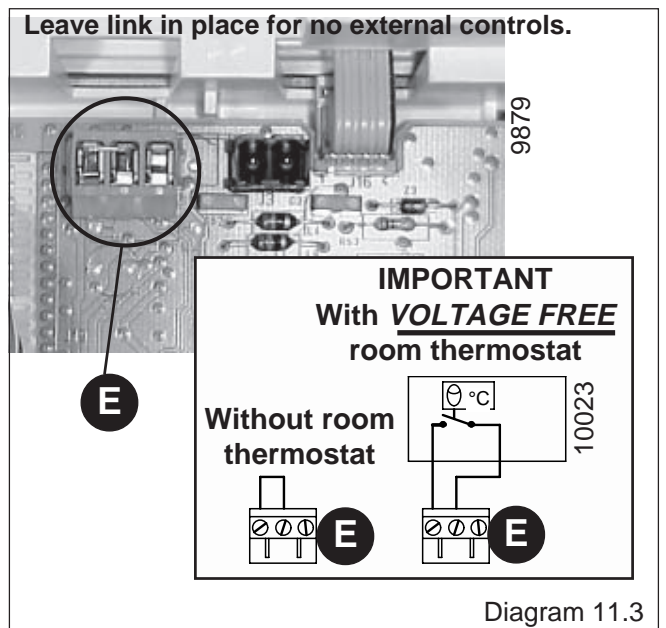
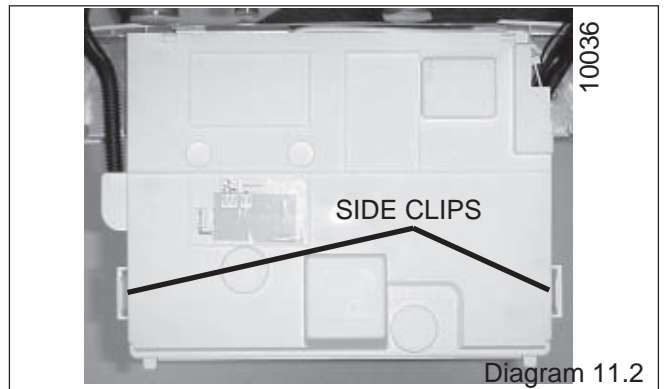
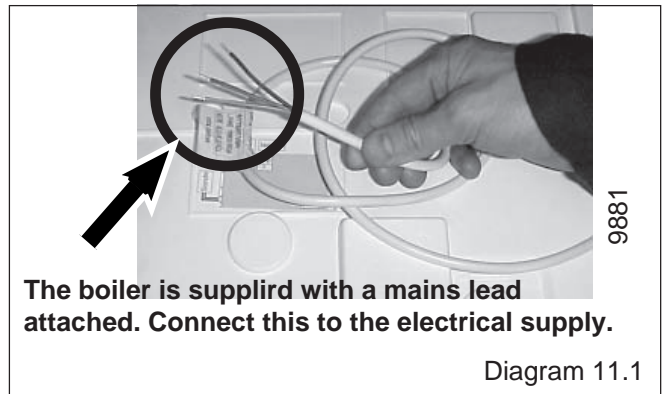

12 Commissioning

Please ensure the "Benchmark" logbook is completed and left with the user.

The commissioning and first firing of the boiler must only be done by a qualified registered person.

Gas valve settings. Refer to Section 15 "Settings".

Gas installation

It is recommended that any air is purged from the supply at the gas inlet test point on the gas valve, see **diagram 12.1**.

Filling the system 1 to 8

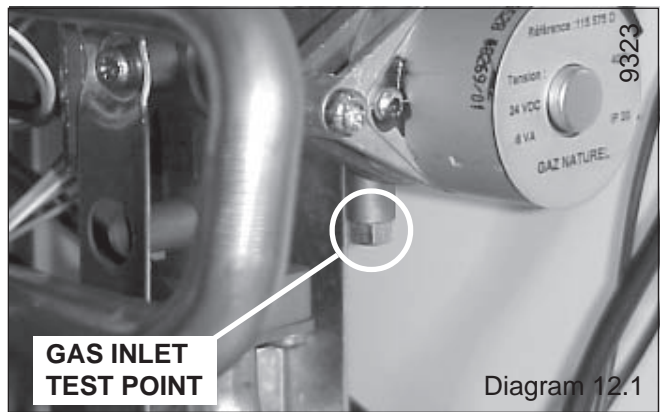
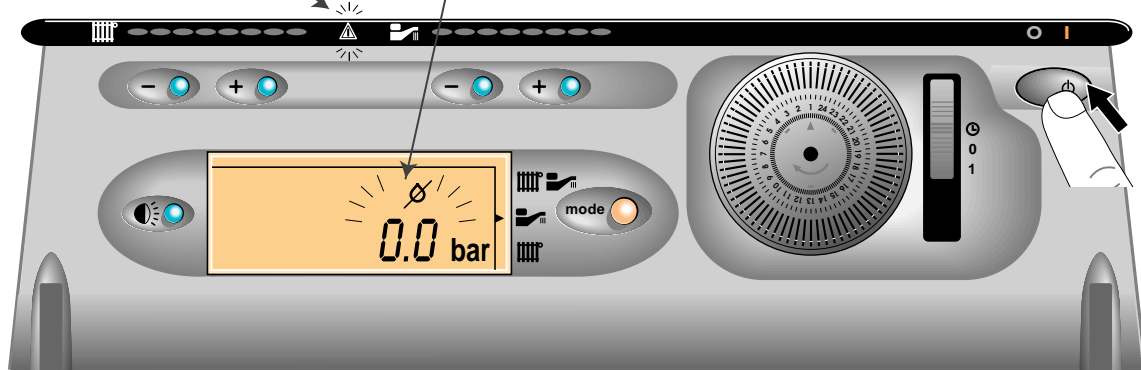

Diagram 12.1

1 Press the mains 'On/Off' button

The warning light will illuminate

The display will indicate 0 bar pressure in the system



Hab 265

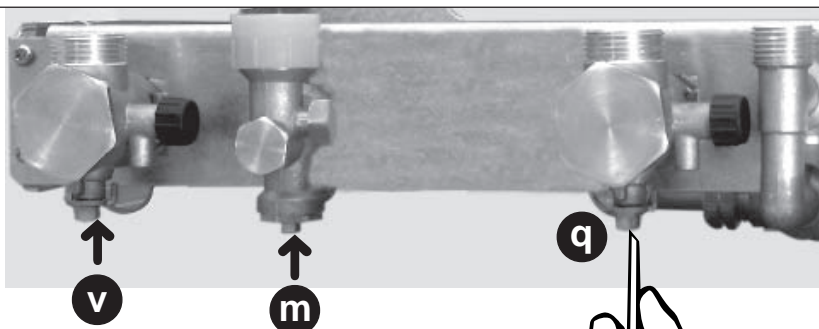

- 2** Open the boiler isolating valves (v and q), the slot of the screw corresponds to flow direction. Fully open valve m by turning anti-clockwise.

3

Undo cap on automatic air vent on top of pump and leave undone.

Reg 008

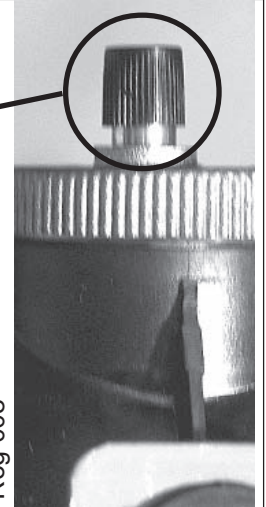

- 4** Open the system filling loop and fill the system until the pressure indicated on the display is between 1 and 2 bar.

The pressure must be between 1 and 2 bar

Hab 265

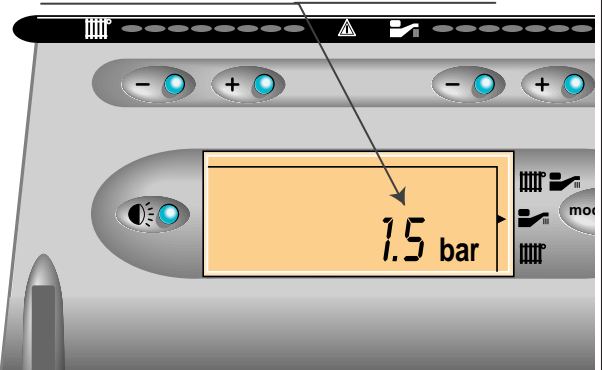

12 Commissioning

- 5** Bleed each radiator to remove the air, re-tighten bleed screws.

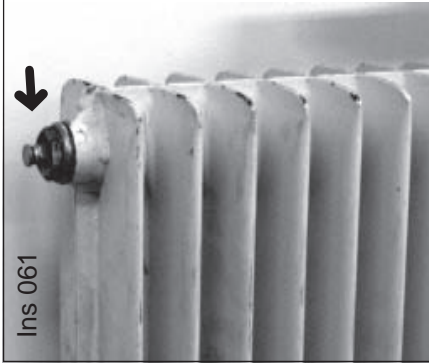

- 6** Leave the cap on the pump auto air vent open.

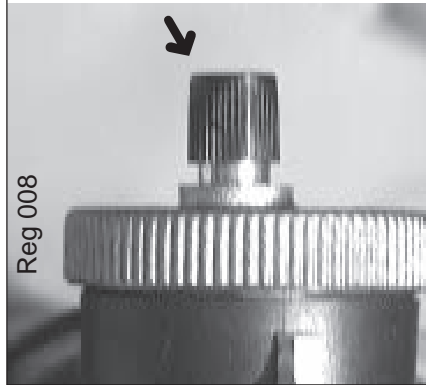

- 7** Open various hot water taps to bleed system.

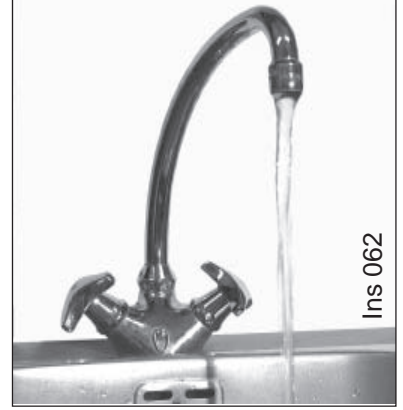

- 8** Make sure the display indicates a system pressure of between 1 and 2 bar. Re-fill system as necessary. (The warning light will extinguish at 1 bar).

The pressure must be between 1 and 2 bar

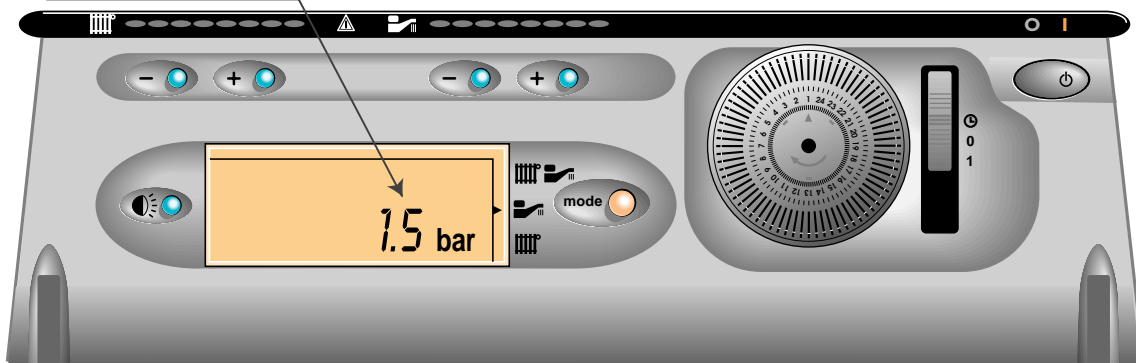

12 Commissioning

Lighting the boiler:

Make sure that:

- The boiler is connected to the electrical supply.
- The gas service cock is open.

Then follow the instructions below :

A Press the On/Off button (1)

The pressure must be between 1 and 2 bar. If not, the system must be filled by a competent person.

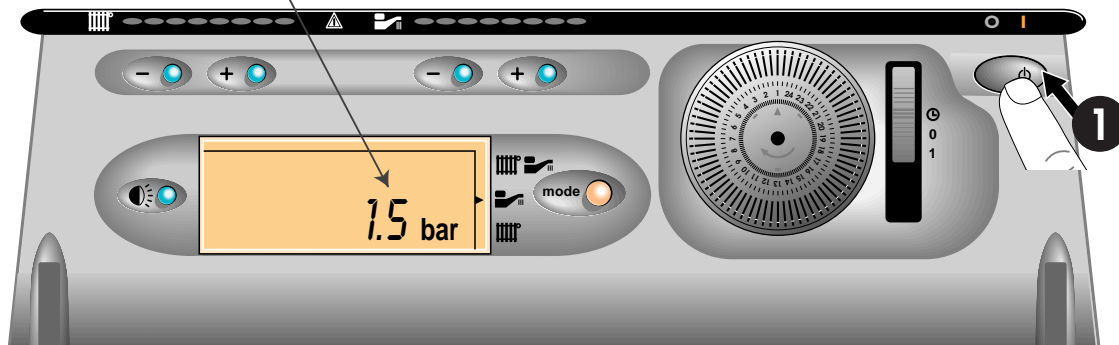

Hab 264

To stop the boiler: Press button 1.

Setting to the WINTER position (Heating + hot water)

B Press the **mode** button to select the **winter** symbol

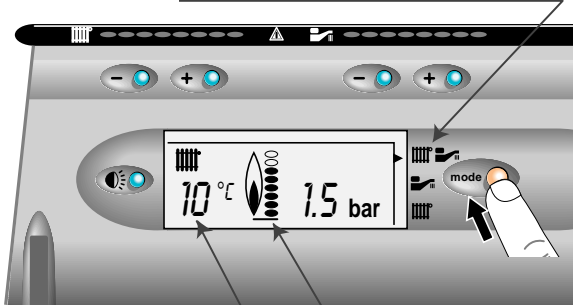

The actual temperature of the heating system

Illuminates when the boiler lights

- Adjust heating temperature to maximum 87°C.
- Check that any external controls, if fitted, are calling for heat (set room thermostat to maximum).
- Allow the temperature to rise to the maximum value, with all radiator valves open. The temperature rise will cause release of the gases contained in the water of the central heating system.
- Gases driven towards the boiler will be automatically released through the automatic air vent.
- The gases trapped at the highest point of the system must be released by bleeding the radiators. Check the burner gas rate required, ten minutes from lighting. Refer to Data Label on electrical controls box. Should there be any doubt about the gas rate it should be checked at the meter.

On reaching maximum temperature, the boiler should be turned off and the system drained as rapidly as possible whilst still hot.

Adjusting the heating temperature

C Press + or - to adjust the maximum temperature of the heating (38°C to 87°C)

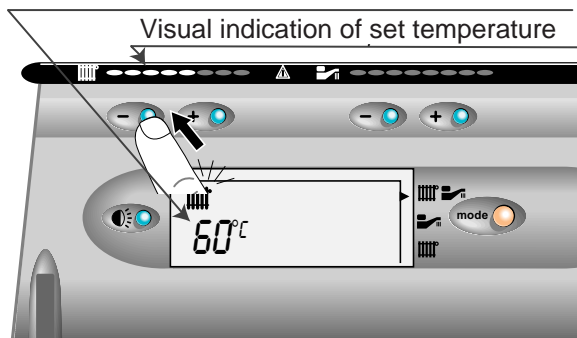

Hab 261

- Refill system to a pressure of between 1 and 2 bar and vent as before.

- Restart boiler and operate until a maximum temperature is reached. Shut down boiler and vent heating system. If necessary, top up heating system and make sure that a pressure of at least 1 bar is indicated when system is COLD.

13 Safety Devices

The **XTRAFAST** incorporates a visual display that indicates fault conditions, should they occur.

In the event of a fault, the display will indicate, by means of pictograms and/or letters and numbers, exactly in which area the fault lies.

Should the boiler fail to operate during Commissioning, the most likely fault is that the gas supply to the boiler has not been turned on or purged sufficiently or that there is no pressure in the heating system. These are indicated as follows :

13.1 No gas supply

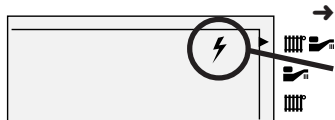

This will be indicated on the display as a pictogram of a spark. To rectify this, proceed as follows:

- Switch off the boiler at the On/Off push button.
- Rectify the gas supply problem.
- Restart the boiler by pressing the On/Off button.

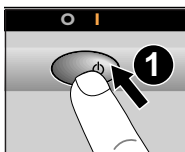

13.2 Insufficient system pressure

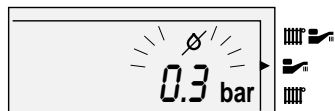

This will be indicated on the display as a flashing warning indicating the system pressure is low. To rectify this the system must be re-filled, refer to '**Section 12 Commissioning**'.

13.3 Other faults

These are indicated on the display by a fault code and a telephone symbol. Further information on the fault codes can be found in the '**Section 17 Fault Finding**'.

General safety devices

13.4 Air flow rate safety device

If an obstruction, even partial, of the flue occurs, for any reason whatsoever, the built in safety system of the boiler will turn the boiler OFF and the fan will continue to run.

The boiler will be ready to operate when the fault has been cleared.

13.5 Overheat safety

In case of boiler overheating, the overheat thermostat will turn the boiler off. The thermostat will need to be manually reset. To do this remove the front panel and sealed chamber cover, locate the reset button on the heat exchanger flow pipe, refer to **Sections 16.3, 16.4, 16.5 and diagram 19.15**.

13.6 In case of power supply failure

The boiler no longer operates.

As soon as power supply is restored, the boiler will be automatically restarted.

13.7 Frost protection

The **XTRAFAST** has a built in frost protection device that protects the boiler from freezing. If the boiler is to be left and there is a risk of frost, ensure that the gas and electrical supplies are left connected. The frost protection device will light the boiler when the temperature of the boiler water falls below 6°C. When the temperature reaches 16°C, the boiler stops.

Note : This device works irrespective of any room thermostat setting and will protect the complete heating system.

14 Changing Gas Type

Should it become necessary to change the gas type, a modification kit will be required.

This modification must only be carried out by a suitably qualified engineer.

Conversion natural Gas (G20) to G30/G31 Part No. 86216.

15 Settings

Bypass

The *XTRAFast* boiler has a built-in bypass. This must be adjusted according to the requirements of the system, refer to the flow rate pressure curve (**diagram 4**). The boiler is supplied with the built-in bypass open a half a turn. It is adjusted by turning the bypass screw (**a**), **see diagram 15.1**. Turn the screw clockwise to close the bypass. When using thermostatic radiator valves (TRV's) on all of the radiators, it is essential that a separate, adjustable bypass of 15 mm minimum diameter is fitted between the flow and return of the heating circuit, **see diagram 8.2**. Any bypass must be fitted before system controls.

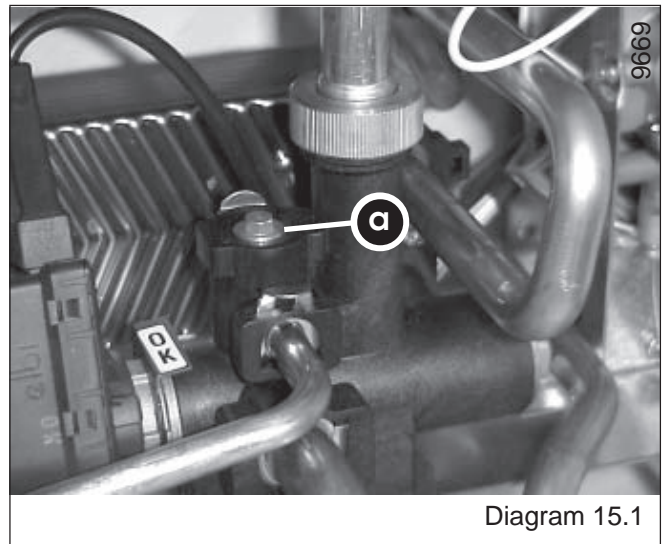

Diagram 15.1

16 Routine Cleaning and Inspection

To ensure the continued efficient and safe operation of the boiler it is recommended that it is checked and serviced at regular intervals. The frequency of servicing will depend upon the particular installation conditions and usage, but in general once a year should be enough.

It is the law that any servicing is carried out by a competent person.

All parts are replaced in reverse order to removal.

16.1 Products of combustion check, refer to diagram 16.1

Note: To obtain a products of combustion reading, unscrew the left hand sampling point cap on the flue elbow, located on top of boiler.

Connect the analyser tube onto sampling point.

Switch on the electrical supply and gas supply, then operate the boiler.

On completion of the test switch off the electrical supply and the gas supply, remove analyser tube and replace sampling point cap.

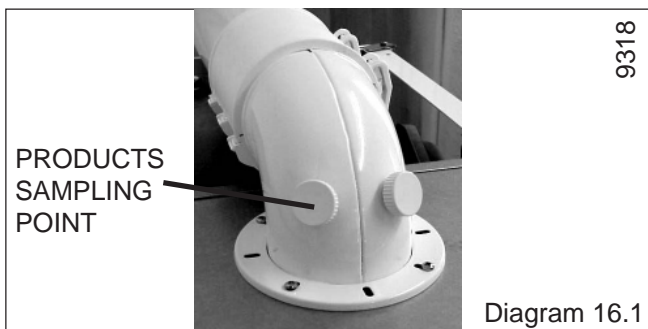

16.2 Service Check and Preparation.

- Operate boiler and check for any faults that need to be put right.
- Isolate boiler from the gas and electrical supplies.
- On completion check all gas-carrying parts for soundness with leak detection fluid.
- Remove boiler casing as follows:

16.3 Front panel

- Unscrew and remove the two front panel retaining brackets from the top of the boiler.
- Remove panel by lifting up and forward.

16.4 Control panel

- Lift control panel up and lower forwards to gain access to lower part of boiler.

16.5 Sealed chamber cover

- Unclip the two toggle clips holding the sealed chamber cover, see diagram 16.2.
- Lift cover up and off boiler.

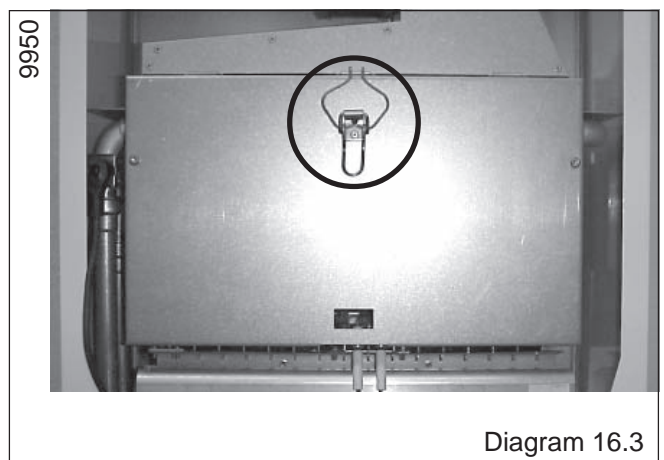

16.6 Side panels (For ease of access if required)

- Unscrew and remove the four screws securing lower grille onto boiler. Unhook grille from rear of boiler and remove.
- Remove three screws from front of each side panel.
- Unclip the toggle clip at the top of each side panel.
- Lift each panel up and then forward to remove.

16.7 Combustion chamber cover

- Unscrew the two screws securing combustion chamber cover to combustion chamber then unclip the two toggle clips, see diagram 16.3.
- Remove combustion chamber cover from boiler.

16 Routine Cleaning and Inspection

16.8 Burner, refer to diagram 16.4.

- Undo main gas supply nut from under the sealed chamber.
- Note: The washer between main burner and main burner gas supply must be kept for use on reassembly.
- Pull off ignition leads from gas control valve.
 - Slacken but do not remove, two burner support screws at rear of burner chamber using a long blade screw driver.
 - Ease burner from boiler by lifting up from key hole slots, threading the gas supply and ignition leads through the grommets and pulling forwards, (taking care not to damage the insulation). Before you completely remove the burner pull off flame sense lead from flame sense electrode.
 - Clean burner by washing in soapy water. Dry thoroughly before refitting.
 - When refitting burner ensure that the burner locates and seals correctly through the grommets.

Note: To gain access to injectors for removal, refer to **Section, 19.24 in Replacement of Parts.**

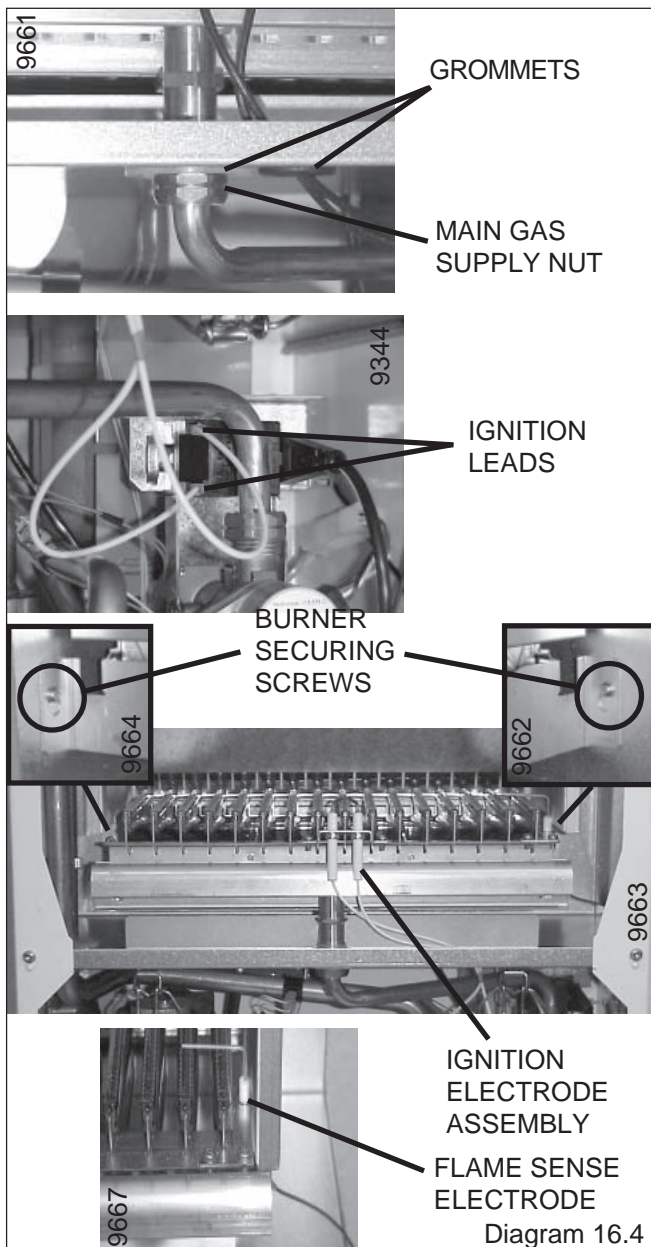

16.9 Heat exchanger, refer to diagram 16.5.

- Disconnect electrical leads from fan.
- Unscrew and remove two fan retaining screws from the right hand side edge of fan mounting plate.
- Remove fan with mounting plate attached by pulling forward and out of boiler.
- Remove air pressure switch sensing tube from sensing probe on flue hood.
- Remove screws securing flue hood to rear panel
- Lift flue hood clear of heat exchanger and examine for debris.
- Using a soft brush or vacuum clean as required.

DO NOT USE ANY TOOL LIKELY TO DAMAGE PAINTED FINISH OF HEAT EXCHANGER.

Note: When re-fitting fan, make sure that the two lugs on the fan mounting plate engage in the flue hood

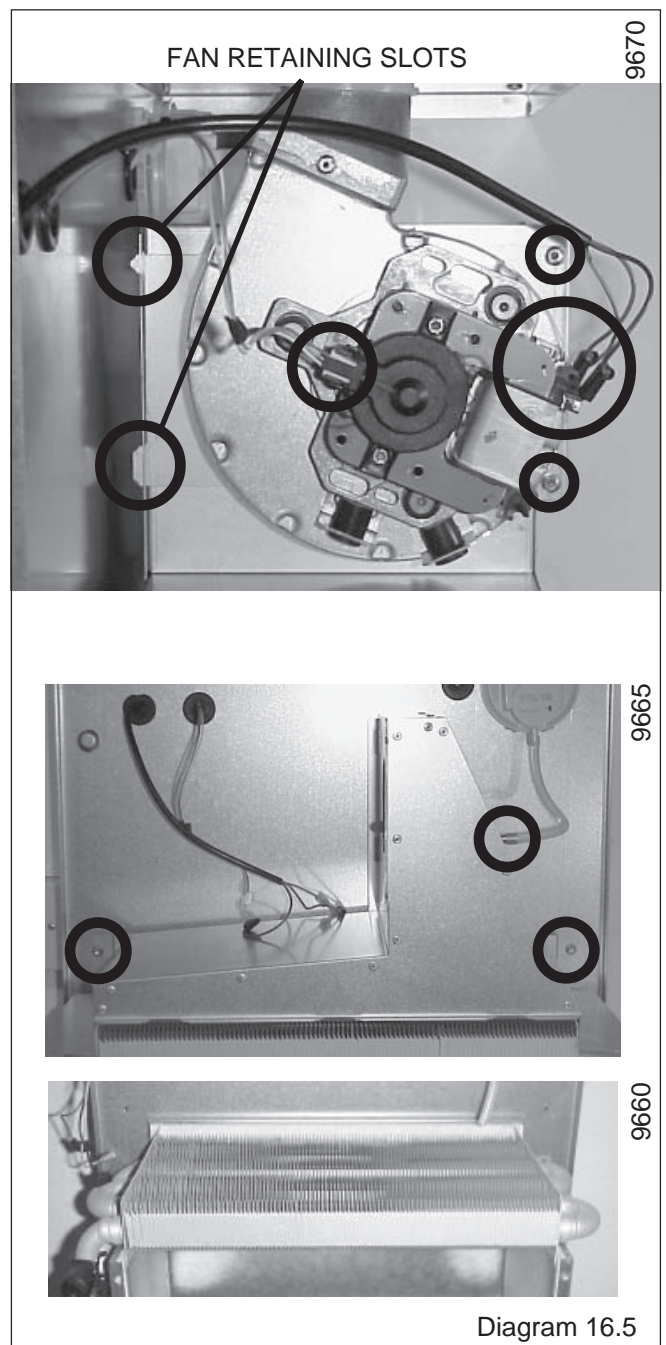

16 Routine Cleaning and Inspection

16.10 Spark and Sense Gaps

- Check that the spark and sense gaps as shown in **diagram 16.6**.

16.11 Flue system

- Check externally to make sure that flue is not blocked
- Inspect flue system to make sure that all fittings are secure.

16.12 Operation of fan

- Switch on electrical supply and turn on gas.
- Light burner by opening a hot water tap.
- Check that fan operates when burner lights and stops when it goes out.

16.13 Cold water inlet filter

Drain down domestic hot water circuit of boiler only, as follows:

- Close isolating valve/throttle (**m**) on cold water isolating cock, **see diagram 7.1**.

Note: This valve is closed when screwed fully clockwise.

- Undo connecting nut from boiler cold water inlet connection.
- Clean and inspect filter, replace if necessary, **see diagram 16.7**.
- With both filter and restrictor in place, reconnect connecting pipe to inlet connection and tighten.
- Fully open isolating valve/throttle on cold water inlet and check for leaks.

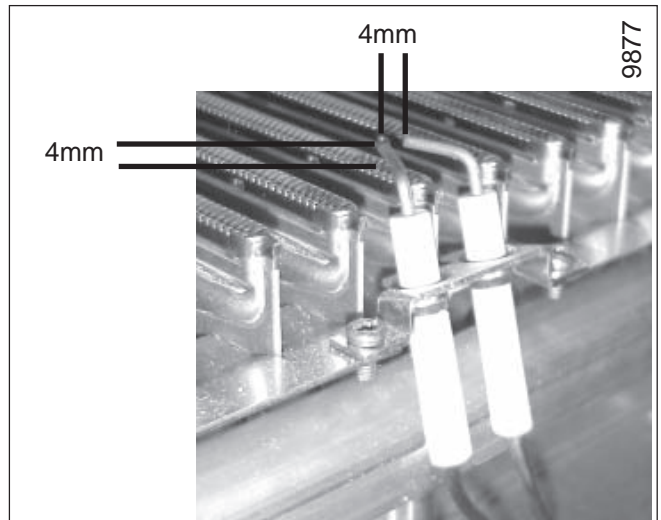

SPARK GAP

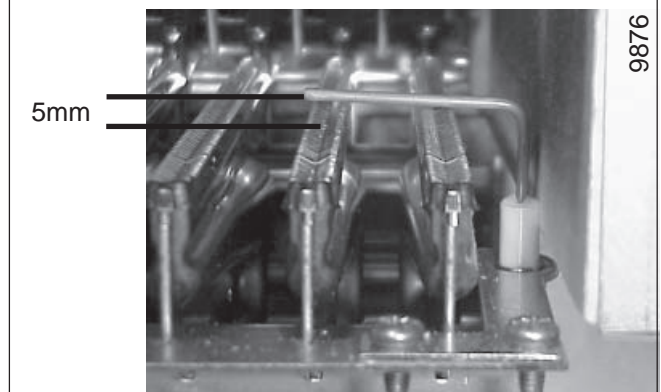

SENSE GAP

Diagram 16.6

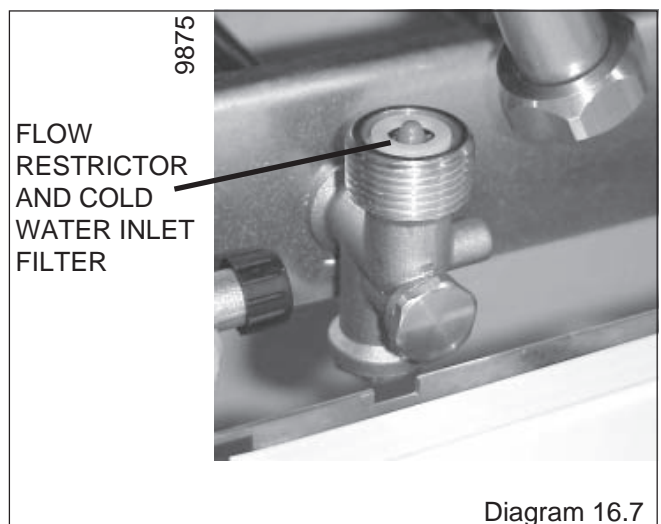

Diagram 16.7

17 Fault Finding

Fault finding must be carried out by a competent person.

WARNING. Always isolate the boiler from the electrical supply before carrying out any electrical replacement work.

On completion of a fault finding task that has required the disconnection and making of electrical connections then check for earth continuity, polarity and resistance to earth must be carried out.

If any gas-carrying components are disturbed, removed or replaced it will be necessary on completion to check for gas soundness with leak detection fluid.

Before trying to operate the boiler make sure that :

- All gas supply cocks are open and that the gas supply has been purged of air.

- There is a permanent mains supply to the boiler.
- The heating system pressure is at least 1 bar.
- The fuse on the PCB is intact.

Preliminary electrical system checks, as outlined in a multimeter instruction book, are the first checks to be carried out during a fault finding procedure.

Should there be any doubt about the voltage supply to any of the components, it is possible to carry out a simple electrical test to ensure all is operational in that area.

To carry out the electrical test, gain access to the main Printed Circuit Board (PCB) , and measure the voltages according to table 2.

Table 2

Voltage	Measured value	Measuring point
230 Volt	230 V AC	Between terminals H8.1 and H8.2
24 Volt	maximum 33V DC minimum 20V DC	Between terminals B2.4 and B2.7
15 Volt	15V \pm 0.5V	Between terminals B2.4 and B2.2
Display	5V \pm 0.5V	Between terminals B2.4 and B4.2

The In-board fault diagnostic system. Should a fault occur on the boiler, the warning LED at the top of the user display will illuminate and the LCD display will indicate the precise area where the fault has occurred.

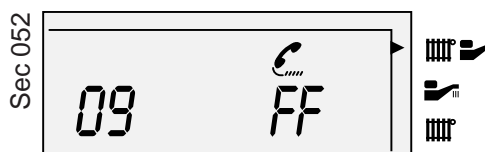

A fault code is displayed on the left hand side of the LCD display, whilst at the same time, the letters appear with a telephone symbol.

Thermistor values

The following table applies to the central heating, domestic hot water and storage vessel thermistors:

Temperature (°C)	Resistance (Ω)
0	32565
5	25345
10	19875
15	15700
20	12500
25	10000
30	8060
35	6535
40	5330
45	4370
50	3605
55	2989
60	2490
65	2085
70	1755
75	1480
80	1260
85	1070
90	920
95	785
100	680











System pressure sensor

The resistance of the sensor at various pressures is as follows :









0 bar	between 280 Ω and 320 Ω
1 bar	between 195 Ω and 220 Ω
3 bar	between 93 Ω and 143 Ω

17 Fault Finding

TO AID FAULT FINDING REFER TO DIAGRAMS 5.1 AND 18.1.

CODE	TYPE OF FAULT	DISPLAY SYMBOL	CHECK
00	NO FAULT		NO FAULT
02	AIR FLOW SAFETY		<p>THIS SYMBOL IS NOT INSTANTANEOUS BUT IF IT APPEARS AFTER 40 SECONDS, CHECK</p> <ul style="list-style-type: none"> • THE FLUE SYSTEM FOR A BLOCKAGE, EXCESS LENGTH. • CHECK THE AIR PRESSURE SWITCH. • CHECK THE ELECTRICAL CONNECTIONS.
04	NO IGNITION Note: MAX. IGNITION TIME = 7 SECONDS		<p>IF THE BURNER LIGHTS WITH A TRAIN OF SPARKS AND GOES OUT AFTER 7 SECONDS.</p> <ul style="list-style-type: none"> • REVERSE LIVE AND NEUTRAL TO THE ELECTRICAL PLUG. • CHECK THE ELECTRODE AND ITS CORRECT CONNECTION. • CHECK IGNITION BOX. • CHECK THERE IS MORE THAN 40V BETWEEN LIVE AND EARTH. <p>IF THE TRAIN OF SPARKS DOES NOT LIGHT THE BURNER, CHECK .</p> <ul style="list-style-type: none"> • THE GAS TAP ON THE INSTALLATION IS OPEN. • THE GAS CONTROL VALVE. • CHECK THE IGNITION BOX.
05	OVERHEATING		<ul style="list-style-type: none"> • PUMP BLOCKED OR ITS CONDENSER OUT OF SERVICE. • ISOLATING COCKS CLOSED ON JIG. • DEFECTIVE OVERHEAT THERMOSTAT. • BLEED OUT AIR. • CHECK THE ELECTRICAL CONNECTIONS.
06 or 07 or 08	HEATING THERMISTOR ON FLOW PIPE DOMESTIC THERMISTOR ON DHW PIPE TEMPERATURE ON STORAGE VESSEL		<ul style="list-style-type: none"> • CIRCUITS OPEN OR SHORT CIRCUIT. • CHECK RESISTANCE OF THE THERMISTOR. (12500 ohms AT 20°C. 1750 ohms AT 70°C). • UNCLIP THE THERMISTOR FROM THE PIPE, IF THE BOILER RE-LIGHTS WHEN THE THERMISTOR IS OPEN CIRCUIT. REPLACE THE THERMISTOR.
09	LOSS OF WATER PRESSURE SENSOR.		<ul style="list-style-type: none"> • SENSOR IN SHORT CIRCUIT OR HAS ISOLATION FAULT. • CHECK THE ELECTRICAL CONNECTIONS.
12	USER INTERFACE		<ul style="list-style-type: none"> • INTERFACE MAY BE DAMP. DRY IT OUT OR REPLACE.
13	MAIN CONTROL BOARD (PCB)		<p>THIS FAULT MAY BE INTERMITTENT.</p> <ul style="list-style-type: none"> • SWITCH (OFF), WAIT APPROXIMATELY 5 SECONDS, SWITCH (ON). • IF FAULT PERSISTS. REPLACE MAIN CONTROL BOARD (PCB).
14	TEMPERATURE LIMITER. CONTROLLED BY THE HEATING THERMISTOR ON FLOW PIPE.		<ul style="list-style-type: none"> • CHECK HEATING THERMISTOR (MAY BE UNCLIPPED) OR THREE WAY VALVE FAULTY. • FAULTY PUMP. • LOW HEATING FLOW RATE.
20	COMMUNICATION FAULT		<p>THIS FAULT MAY BE OCCASIONAL AND CAUSED BY ELECTROMAGNETIC INTERFERENCE. OTHERWISE</p> <ul style="list-style-type: none"> • CHECK THE MAIN CONTROL BOARD (PCB).

OTHER FAULTS NOT DISPLAYED BY FAULT CODE

NO HEATING		<p>THERE IS DEMAND BY THE ROOM TEMPERATURE THERMOSTAT.</p> <ul style="list-style-type: none"> • CHECK THE CONNECTIONS. IF FAULT PERSISTS, REPLACE MAIN CONTROL BOARD (PCB).
NO HEATING. NO DISPLAY OF RADIATOR SYMBOL. 		<ul style="list-style-type: none"> • CHECK THAT CONTACT 1 IS ON 1. OR MEASURE A RESISTANCE < 10 ohms BETWEEN B5.1 AND B5.2. • CHECK ROOM THERMOSTAT CONNECTIONS OR MEASURE A RESISTANCE < 50 ohms BETWEEN B3.1 AND B3.2.
WATER NOT HOT ENOUGH, OR UNEVEN FLOW FROM TAP. THERE IS A HOT WATER DEMAND.		<ul style="list-style-type: none"> • CHECK THREE WAY VALVE. • CHECK THREE WAY VALVE MOTOR (SWITCHING). • CHECK THE DIRECTION OF • CLIP ON THREE WAY VALVE (READABILITY OF SYMBOL ). • MEASURE THE MICROFAST RESISTANCE [®] = 1000 ohms BETWEEN H4.1 AND H4.3.
WATER NOT HOT ENOUGH, OR UNEVEN FLOW FROM TAP. NO DISPLAY OF TAP SYMBOL. 		<ul style="list-style-type: none"> • READ THE VALUE OF FLOW RATE DETECTOR ON CODE 07 OF INFO MENU. IT WILL READ HOT WATER OUTPUT (L/MIN.)(x10) VALID RANGE 00,,,199 NOTE: DIVIDE THE VALUE BY 10. IF = 0 THE DETECTOR IS BLOCKED OR FAILED. IF = 0 THE DETECTOR IS BLOCKED OR THE MAIN CONTROL BOARD (PCB) HAS FAILED.
THE BURNER COMES ON WHEN COLD WATER IS DRAWN OFF.		<ul style="list-style-type: none"> • CHECK THAT THE HOT WATER CIRCUIT HAS BEEN BLED PROPERLY (ANY AIR BUFFER MAY ACTIVATE THE FLOW RATE DETECTOR WHEN THE TAPS ARE TURNED ON).

18 Wiring Diagram

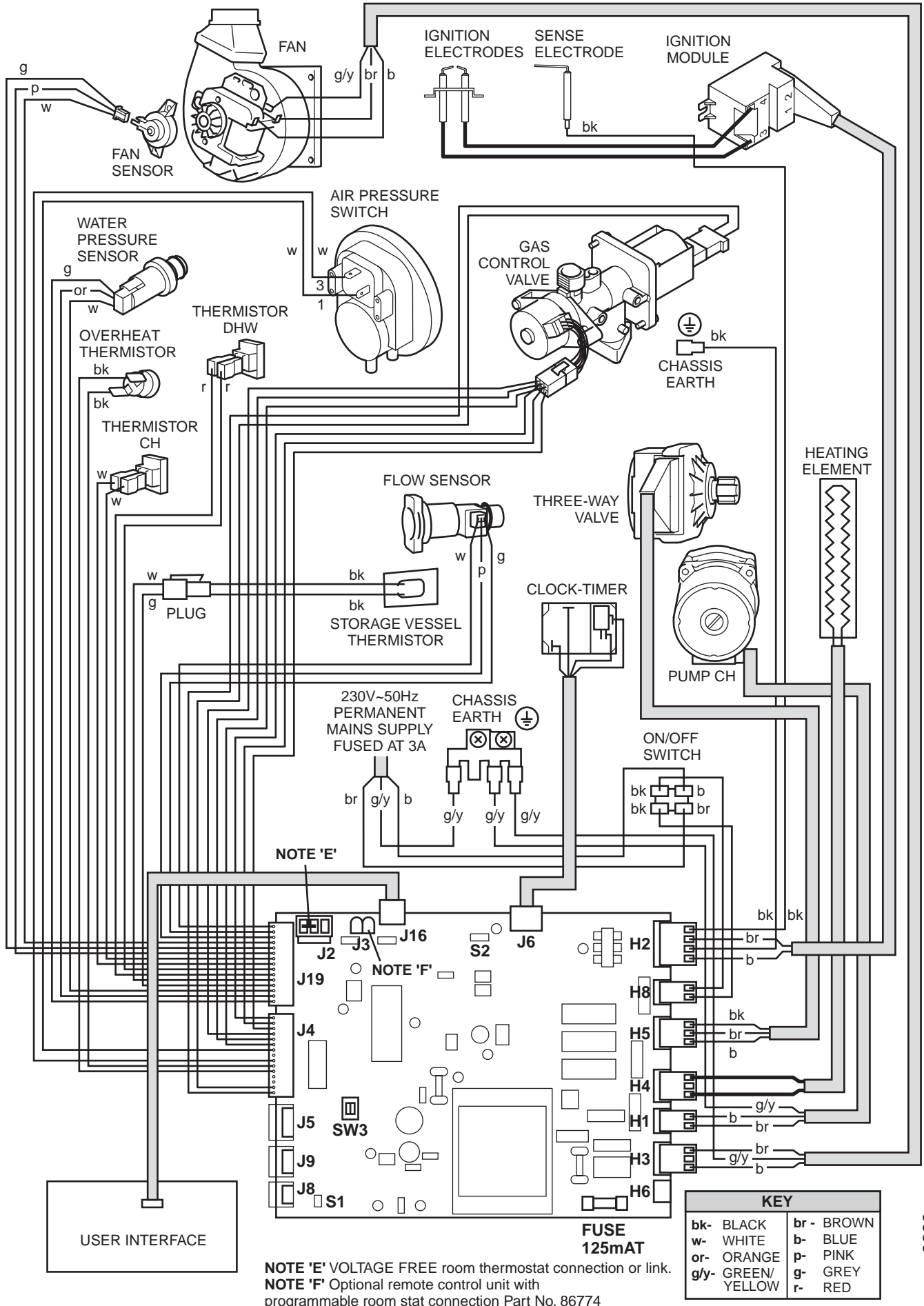

9683

Diagram 18.1

19 Replacement of Parts

IMPORTANT INFORMATION

WARNING: Before commencing the replacement of any component, isolate appliance from electrical supply and turn off gas at service cock.

Replacement of parts must be carried out by a competent person.

When replacing components it may be necessary to renew sealing washers, gaskets and 'O' rings. If new ones are supplied with replacement components they must be used.

All parts are replaced in reverse order to removal.

If any gas-carrying components are disturbed, removed or replaced it will be necessary on completion to check for gas soundness with leak detection fluid.

19.1 Domestic hot water thermistor, refer to diagram 19.1

Before starting refer to the front of **Section 19 Important information**.

- Remove the front panel, refer to **Section 16.3**.
- Lower the control panel, refer to **Section 16.4**.
- Locate domestic hot water thermistor on hot water flow pipe on right hand side of boiler adjacent to gas control valve.
- Unclip thermistor from pipe.
- Disconnect leads from thermistor.
- Fit leads to replacement thermistor and fit thermistor to pipe. The polarity is not important.

19.2 Central heating thermistor, refer to diagram 19.2

Before starting refer to the front of **Section 19 Important information**.

- Remove the front panel, refer to **Section 16.3**.
- Lower the control panel, refer to **Section 16.4**.
- Locate central heating thermistor on heating flow pipe on centre of boiler.
- Unclip thermistor from pipe.
- Disconnect leads from thermistor.
- Fit leads to replacement thermistor and fit thermistor to pipe. The polarity is not important.

19.3 Fan, refer to diagram 19.3

Before starting refer to the front of **Section 19 Important information**.

- Remove the front panel, refer to **Section 16.3**.
- Lower the control panel, refer to **Section 16.4**.
- Remove the sealed chamber cover, refer to **Section 16.5**.
- Disconnect power supply leads and earth lead from fan.
- Unscrew and remove two fan retaining screws at front edge of mounting plate.
- Remove fan with mounting plate attached by pulling forwards out of the boiler.
- Remove fan from mounting plate.

Note: When re-fitting, make sure that the two lugs on the fan mounting plate engage in the flue hood.

- Reconnect electrical leads.

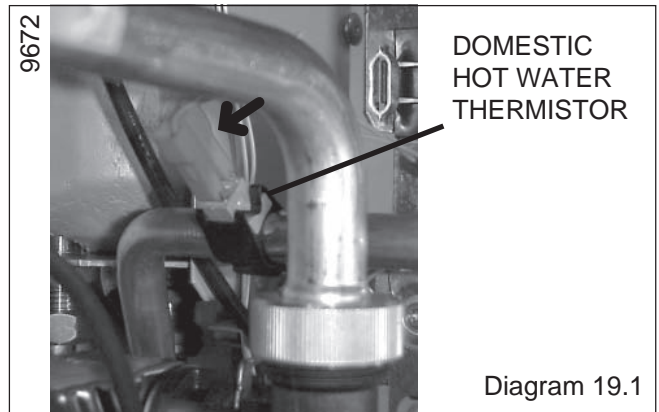

Diagram 19.1

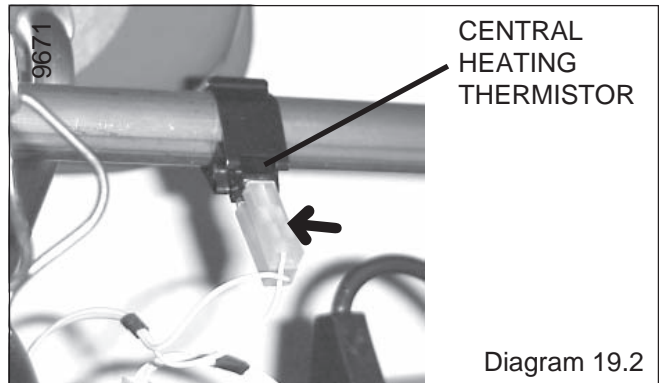

Diagram 19.2

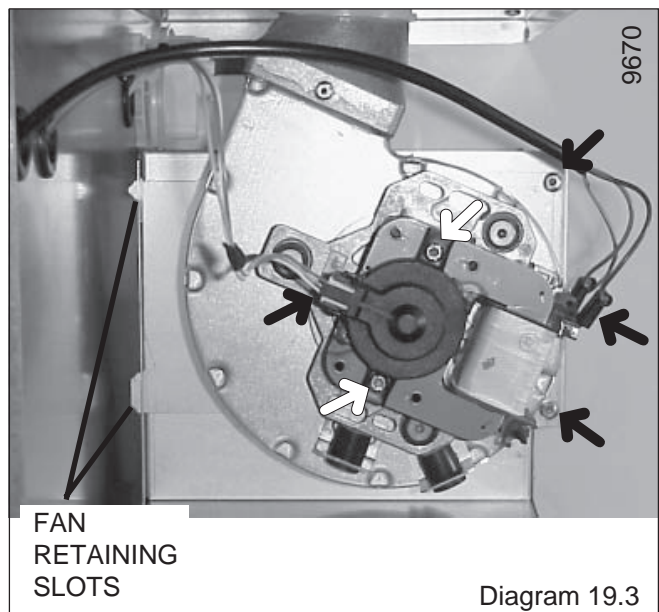

Diagram 19.3

19.4 Fan sensor, refer to diagram 19.3

Before starting refer to the front of **Section 19 Important information**.

- Remove the front panel, refer to **Section 16.3**.
- Lower the control panel, refer to **Section 16.4**.
- Remove the sealed chamber cover, refer to **Section 16.5**.
- Remove the 2 fan sensor retaining screws.
- Remove the fan sensor and disconnect the electrical connection, avoid straining the cables.

19 Replacement of Parts

19.5 Air pressure switch, refer to diagram 19.4

Before starting refer to the front of **Section 19 Important information**.

- Remove the front panel, refer to **Section 16.3**.
- Lower the control panel, refer to **Section 16.4**.
- Remove the sealed chamber cover, refer to **Section 16.5**.
- Locate air pressure switch situated inside combustion chamber on top right hand side.
- Remove air pressure switch tube.
- Disconnect air pressure switch electrical connections.
- Undo screws on top of boiler securing air pressure switch to boiler and remove switch.

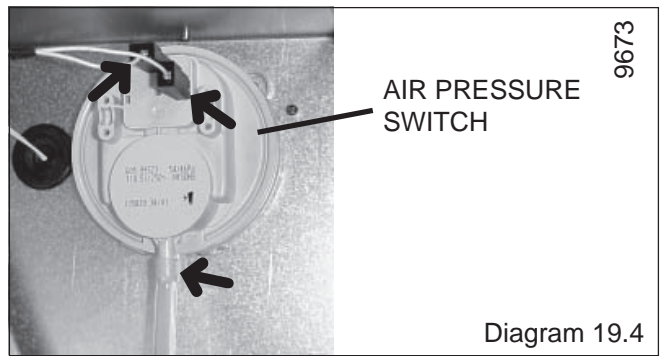

Diagram 19.4

19.6 Domestic water flow sensor, refer to diagram 19.5.

Before starting refer to the front of **Section 19 Important information**.

- Remove the front panel, refer to **Section 16.3**.
- Lower the control panel, refer to **Section 16.4**.
- Drain down domestic hot water circuit of boiler only, refer to **relevant part of Section 16.13**.
- Locate flow sensor on cold water inlet pipe to boiler inside controls area.
- Carefully pull off electrical connector from flow sensor.
- Pull out slotted metal clip securing cold water inlet pipe to flow sensor disconnect union nut securing cold water inlet pipe to isolating valve and remove.
- Pull out slotted metal clip securing flow sensor to pump mounting, remove sensor.

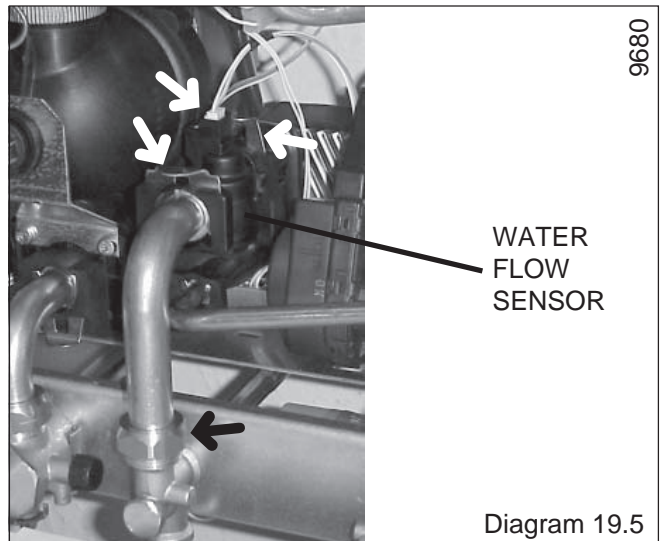

Diagram 19.5

19.7 Printed circuit board (PCB), refer to diagram 19.6

Before starting refer to the front of **Section 19 Important information**.

- Remove the front panel, refer to **Section 16.3**.
- Lower the control panel, refer to **Section 16.4**.
- Gain access to rear of control panel.
- Unclip side clips and hinge up control panel cover to gain access to PCB, see **diagram 11.2**.
- Carefully pull off electrical connections to PCB.
- Unclip and lift out PCB.

Note: Make sure that PCB connections are fully pushed onto replacement PCB.

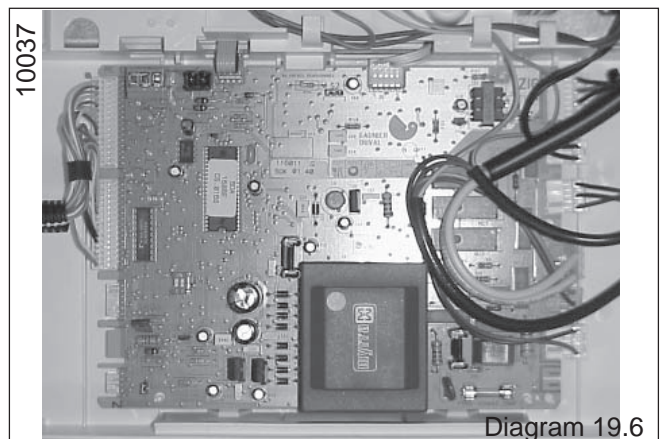

Diagram 19.6

19.8 Central heating pump, refer to diagram 19.7.

Before starting refer to the front of **Section 19 Important information**.

- Remove the front panel, refer to **Section 16.3**.
- Lower the control panel, refer to **Section 16.4**.
- Drain down central heating water circuit of the boiler only, as follows:
 - Close isolating valves (q) and (v) on central heating isolating cocks (A) and (C), see **diagram 7.1**.

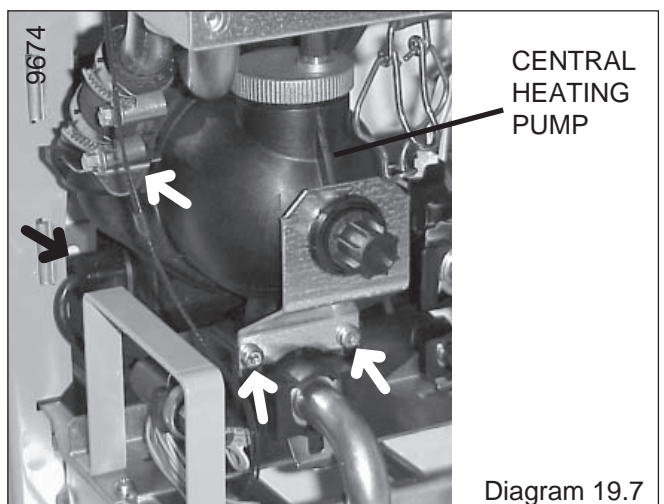

Diagram 19.7

19 Replacement of Parts

Note: These valves are closed when slots are at right angles to direction of flow.

- Drain boiler by opening drain valves (r) and (u), **see diagram 7.1.**

Note: it is not necessary to drain down the entire heating system to carry out this work.

- For ease of access if required remove the left hand side panel, refer to **Section 16.6.**
- Undo two fixing screws and remove pump retaining bracket from front of pump.
- Pull out slotted metal clip securing pump outlet hose connection to pump.
- Remove pump from pump block by lifting up at front and pulling forward.
- Gain access to the pump electrical connection box and remove cover.
- Disconnect pump cable from pump (avoid straining cables).
- Transfer automatic air vent to replacement pump.
- Re-connect electrical connection.
- Open isolating valves on flow and return connections, refill, and pressurise boiler.
- Check for leaks.

19.9 Hot water plate to plate heat exchanger, refer to diagram 19.8.

Before starting refer to the front of **Section 19 Important information.**

- Remove the front panel, refer to **Section 16.3.**
 - Lower the control panel, refer to **Section 16.4.**
 - Drain down central heating and domestic hot water circuits of boiler only, refer to relevant parts of **Sections 16.13 and 19.8.**
 - To gain access to the left hand securing screw. Disconnect the domestic water flow sensor at the plate to plate heat exchanger and cold water inlet. Remove the domestic hot water flow sensor, refer to **Section 19.6.**
 - Supporting domestic heat exchanger, unscrew and remove two screws securing it onto pump mounting and 3-way valve/bypass housing.
 - Remove plate to plate heat exchanger from boiler.
 - Fit replacement plate to plate heat exchanger using new seals, supplied.
- Note:** Plate to plate heat exchanger mounting screws are offset to ensure correct fitting of replacement.

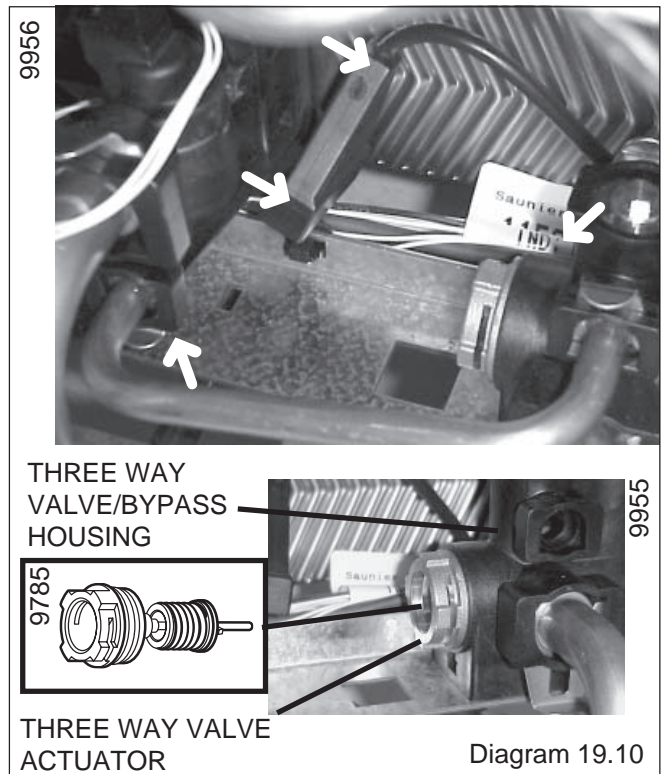
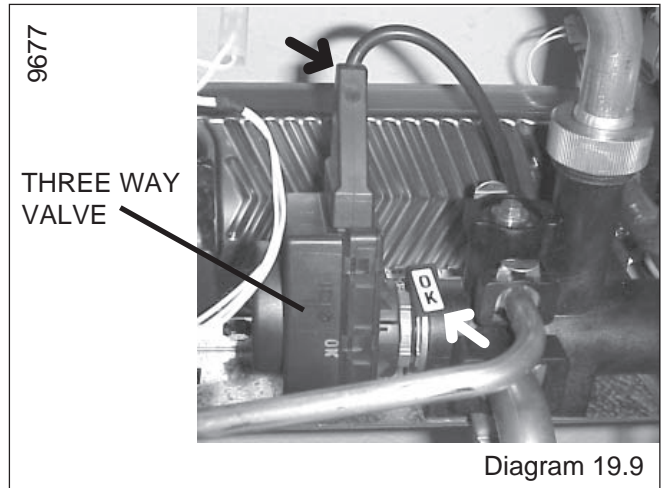
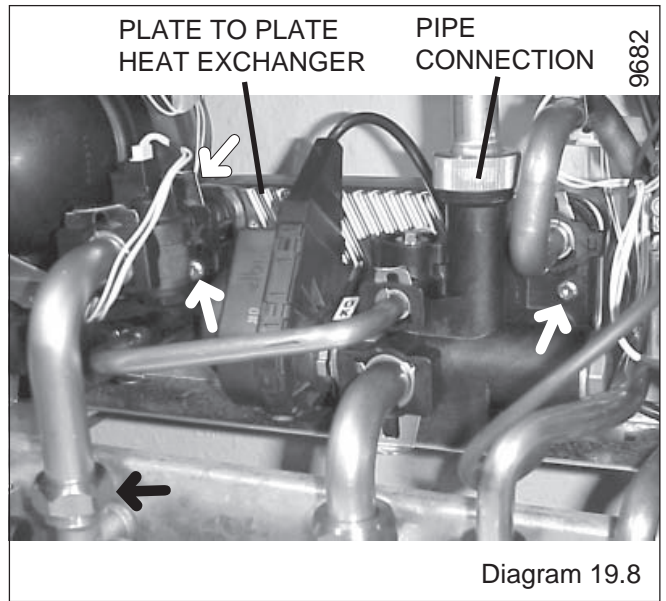

19 Replacement of Parts

19.10 Three-way valve head, refer to diagram 19.9.

Before starting refer to the front of **Section 19 Important information**.

- Remove the front panel, refer to **Section 16.3**.
- Lower the control panel, refer to **Section 16.4**.
- Locate 3- way valve in centre of lower controls area.
- Remove electrical plug from valve head.
- Pull out slotted metal clip from valve body and remove valve head from body.
- Fit replacement valve head.

Note :

- 1) When refitting clip, ensure that letters OK are as shown.
- 2) It is not necessary to drain boiler to carry out this work.

19.11 Three-way valve actuator, refer to diagram 19.10.

Before starting refer to the front of **Section 19 Important information**.

- Remove the front panel, refer to **Section 16.3**.
- Lower the control panel, refer to **Section 16.4**.
- Drain down central heating and domestic hot water circuit of boiler only, refer to relevant parts of **Sections 16.13 and 19.8**.
- Note:** It is not necessary to drain down entire heating system to carry out this work.
- Remove three-way valve head, refer to **Section 19.10**.
- Pull out slotted metal clips and remove bypass pipe.
- Remove three-way valve actuator from three-way bypass valve housing.
- Fit replacement three-way valve actuator into three-way bypass valve housing.

19.12 Bypass, refer to diagram 19.11.

Before starting refer to the front of **Section 19 Important information**.

- Remove the front panel, refer to **Section 16.3**.
- Lower the control panel, refer to **Section 16.4**.

Drain down central heating water circuit and drain the boiler, refer to relevant part of **Section 19.8**.

Note: it is not necessary to drain down the entire heating system to carry out this work.

Pull out slotted metal clips and remove bypass pipe.

Pull out slotted metal clip securing bypass into bypass housing, ease up and out bypass valve using a screw driver.

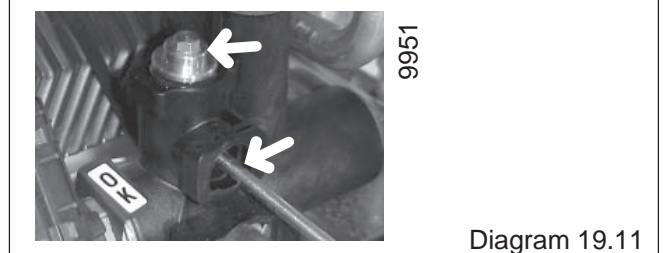
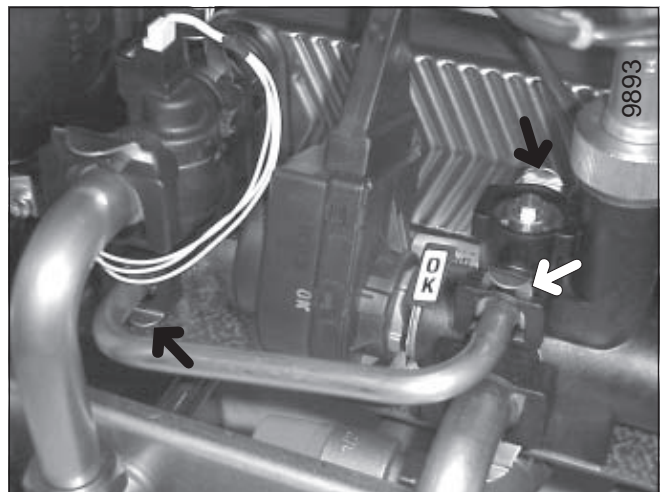
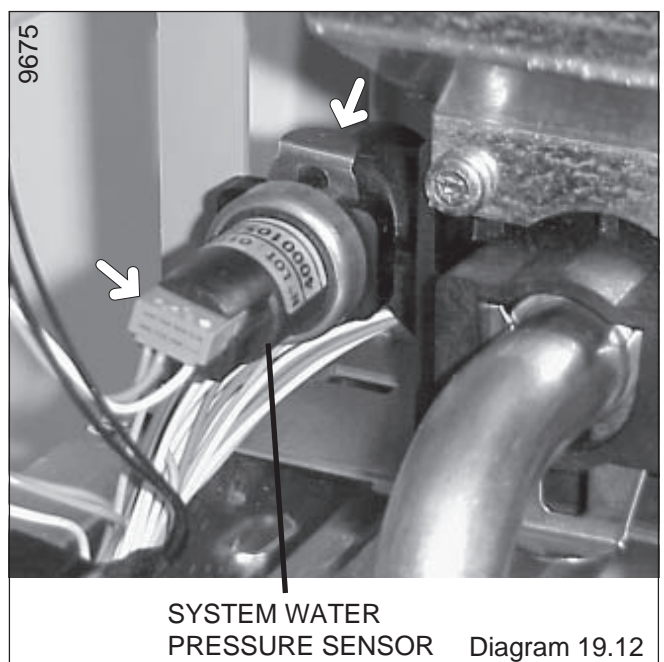

Diagram 19.11



19.13 System water pressure sensor, refer to diagram 19.12.

Before starting refer to the front of **Section 19 Important information**.

- Remove the front panel, refer to **Section 16.3**.
- Lower the control panel, refer to **Section 16.4**.

.Drain down central heating water circuit and drain the boiler, refer to relevant part of **Section 19.8**.

- Locate system water pressure sensor at front left hand side of boiler.
- Pull off slotted metal clip and remove sensor from boiler, take care not to strain cables.
- Remove electrical connection from sensor.

19 Replacement of Parts

19.14 Gas control valve stepper motor, refer to diagram 19.13.

Before starting refer to the front of **Section 19 Important information**.

- Remove the front panel, refer to **Section 16.3**.
- Lower the control panel, refer to **Section 16.4**.
- Locate gas control valve stepper motor attached to front of gas valve.
- Disconnect multi-plug from stepper motor.
- Remove screws securing stepper motor onto gas valve body.
- Withdraw stepper motor from gas valve body.
- Fit replacement stepper motor in reverse order to removal taking care not to damage the 'O' ring.

19.15 Gas Control valve assembly, refer to diagram 19.13.

Before starting refer to the front of **Section 19 Important information**.

- Remove the front panel, refer to **Section 16.3**.
- Lower the control panel, refer to **Section 16.4**.
- Disconnect multi-plug from stepper motor.
- Disconnect electrical connections from spark ignition unit above gas control valve assembly.
- Disconnect electrical connection from R/H side of gas control valve assembly mounting bracket.
- Undo main gas supply nut from main burner, see **diagram 16.4**.

Note: The washer must be kept for use on reassembly.

- Undo main gas union nut between gas control valve supply pipe and gas inlet valve.

Note: The washer must be kept for use on reassembly.

- Unscrew and remove screw securing gas control valve mounting bracket to boiler frame.
- Withdraw gas control valve assembly, pipes and bracket, taking care not to strain the electrical connection at the rear of the gas control valve.
- While supporting the gas control valve assembly disconnect the electrical connection at the rear of the gas control valve, see **diagram 19.13**.
- Using old gas control valve as a guide, transfer gas pipes and bracket from old gas control valve to replacement gas control valve.
- Refit electrical connector to the rear of the gas control valve assembly.
- Fit replacement gas control valve assembly into boiler.
- Reconnect gas pipes.
- Refit electrical connections in reverse order to removal.

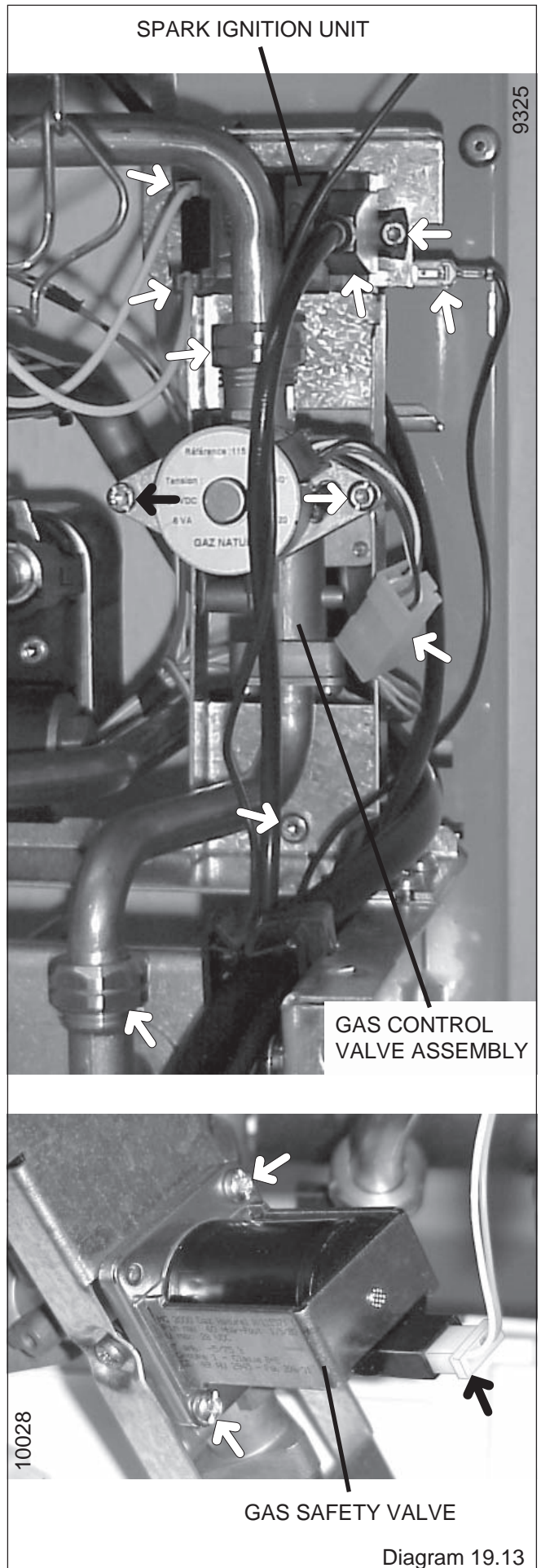

19.16 Gas safety valve, refer to diagram 19.13.

Before starting refer to the front of **Section 19 Important information.**

- Remove the front panel, refer to **Section 16.3.**
- Lower the control panel, refer to **Section 16.4.**
- Remove gas control valve assembly, refer to **Section 19.15.**
- Locate gas safety valve on the rear of the gas valve.
- Unscrew and remove the 2 screws securing the gas safety valve to the gas control valve.
- Fit replacement gas safety valve in reverse order to removal taking care not to damage the 'O' ring.
- Refit electrical connections, the polarity of the wires to the modulating coil is not important.
- Refit electrical connector to the gas safety valve.
- Fit replacement gas control valve assembly into boiler.
- Reconnect gas pipes.
- Refit electrical connections in reverse order to removal.

19.17 Spark ignition unit, refer to diagram 19.13.

Before starting refer to the front of **Section 19 Important information.**

- Remove the front panel, refer to **Section 16.3.**
- Lower the control panel, refer to **Section 16.4.**
- Disconnect electrical connections from spark ignition unit.
- Remove screw securing spark ignition unit to gas valve mounting bracket.
- Replace spark ignition unit.

19.18 Heating safety valve (3 bar), refer to diagram 19.14.

Before starting refer to the front of **Section 19 Important information.**

- Remove the front panel, refer to **Section 16.3.**
- Lower the control panel, refer to **Section 16.4.**

If safety valve seating is damaged, it will be necessary to replace safety valve as a complete unit, repair is not possible.

Drain down central heating water circuit and drain the boiler, refer to relevant part of **Section 19.8.**

- Remove the base panel, secured with four screws and hooked in at the rear.
- If it is not possible to remove the safety valve securing pin (without straining the pipe work), to remove the safety valve. Continue following the removal instructions below.
- Remove the heating flow isolating valve by disconnecting the two union nuts and removing the securing clip.
- Disconnect the heating flow union nut at the safety valve housing.
- Disconnect safety valve discharge pipe from safety valve.
- Remove the safety valve and housing.
- Remove safety valve securing pin.
- Remove safety valve.
- Fit replacement safety valve.

Note: Apply a small quantity of silicon grease to the safety valve 'O' ring prior to fitting.

- Open isolating valves on flow and return connections, refill, vent and pressurise boiler.
- Check for leaks.

19.19 Domestic safety valve (10 bar), refer to diagram 19.14.

Before starting refer to the front of **Section 19 Important information.**

If safety valve seating is damaged, it will be necessary to replace safety valve as a complete unit, repair is not possible.

- Remove the base panel, secured with four screws and hooked in at the rear, see **diagram 19.14.**

Drain down the boiler, refer to relevant part of **Section 19.8.**

- Disconnect safety valve discharge pipe from safety valve.
- Remove wire clip securing safety valve to domestic hot water outlet fitting and remove safety valve.
- Fit replacement safety valve.

Note: Apply a small quantity of silicon grease to the safety valve 'O' ring prior to fitting.

- Open isolating valves on flow and return connections, refill, vent and pressurise boiler.
- Check for leaks.

19.20 Main heat exchanger, refer to diagram 16.5 and 19.15.

Before starting refer to the front of **Section 19 Important information.**

- Remove the front panel, refer to **Section 16.3.**
- Lower the control panel, refer to **Section 16.4.**
- Remove the sealed chamber cover, refer to **Section 16.5.**
- Remove the combustion chamber cover, refer to **Section 16.7.**

Drain down central heating water circuit and drain the boiler, refer to relevant part of **Section 19.8.**

- Disconnect power supply leads and earth lead from fan.
- Unscrew and remove two fan retaining screws from the right hand side edge of fan mounting plate.
- Remove fan with mounting plate attached by pulling forward and out of boiler.
- Remove air pressure switch sensing tube from sensing probe on flue hood.
- Remove screws securing flue hood to rear panel
- Lift flue hood clear of heat exchanger.
- Unclip overheat thermostat from heating flow pipe.
- Pull out slotted metal clips securing pipes from heat exchanger.
- Lift heat exchanger up and forwards to remove from boiler taking care not to damage insulation.

DO NOT DAMAGE PAINTED FINISH OF HEAT EXCHANGER.

- Fit replacement heat exchanger.

Note: When re-fitting fan, make sure that the two lugs on the fan mounting plate engage in the flue hood.

19 Replacement of Parts

- Open isolating valves on flow and return connections, refill, vent and pressurise boiler.
- Check for leaks.

19.21 Overheat thermostat, refer to diagram 19.15.

Before starting refer to the front of **Section 19 Important information**.

- Remove the front panel, refer to **Section 16.3**.
- Lower the control panel, refer to **Section 16.4**.
- Remove the sealed chamber cover, refer to **Section 16.5**.
- Locate high limit thermostat on heating flow pipe on left hand side of boiler
- Disconnect electrical connection from thermostat
- Unclip thermostat from heating flow pipe.
- Fit replacement thermostat in reverse order to removal. (Use heat sink compound supplied).
- Refit connection to thermostat.

19.22 Combustion chamber insulation

Before starting refer to the front of **Section 19 Important information**.

- Remove the front panel, refer to **Section 16.3**.
- Lower the control panel, refer to **Section 16.4**.
- Remove the sealed chamber cover, refer to **Section 16.5**.
- Remove the combustion chamber cover, refer to **Section 16.7**.
- Remove main heat exchanger, refer to **Section 19.20**.
- Remove fan and loosen flue hood, refer to relevant parts of **Sections 19.3 and 16.9**.

Front panel insulation

- Lift front insulation panel free from retaining lugs on combustion chamber cover.

Rear panel insulation

- Pull rear insulation panel free from retaining lug at rear of combustion chamber by tilting forward.
- Fit replacement insulation panels in reverse order to removal
- Refit combustion chamber cover.

Side Panels

Note: Rear panel must be removed first.

- Pull out side panels free from retaining lugs at side of combustion chamber by tilting sideways.
- Fit replacement insulation panels in reverse order to removal.
- Refit combustion chamber cover.

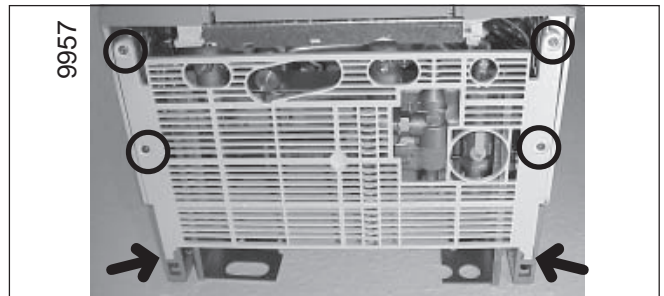

DOMESTIC SAFETY VALVE (10 bar)

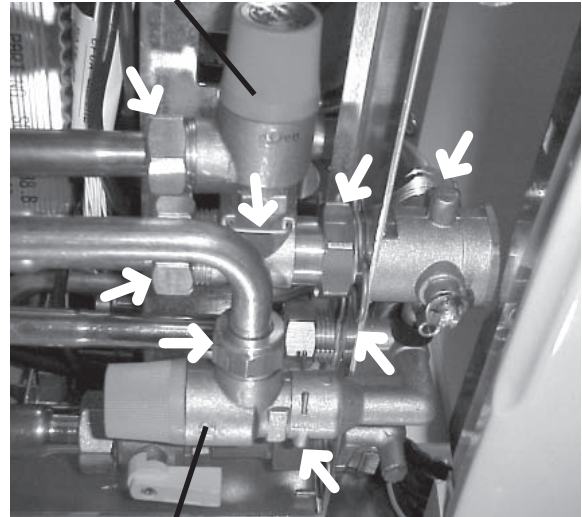

HEATING SAFETY VALVE (3 bar) Diagram 19.14

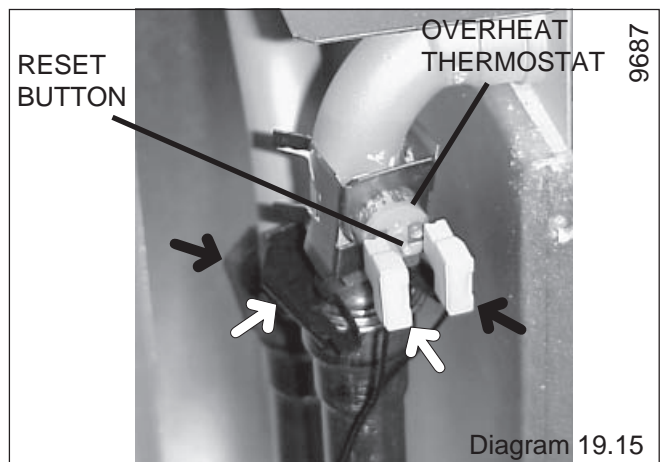

Diagram 19.15

19 Replacement of Parts

19.23 Burner

Before starting refer to the front of **Section 19 Important information**.

- Remove the front panel, refer to **Section 16.3**.
- Lower the control panel, refer to **Section 16.4**.
- Remove the sealed chamber cover, refer to **Section 16.5**.
- Remove the combustion chamber cover, refer to **Section 16.7**.
- Remove burner, refer to **Section 16.8**.

Assemble replacement burner, supplied in parts, as follows:

- Fit burner injectors to burner injector bar and tighten.

Note: Make sure that injector size, marked on each injector, is the same as that given in '**Section 1 Technical Data**' for the type of gas being used.

- Fit injector bar into burner, secure with retaining rods.
- Fit replacement burner.

19.24 Burner injectors, refer to diagram 19.16.

Before starting refer to the front of **Section 19 Important information**.

- Remove the front panel, refer to **Section 16.3**.
- Lower the control panel, refer to **Section 16.4**.
- Remove the sealed chamber cover, refer to **Section 16.5**.
- Remove the combustion chamber cover, refer to **Section 16.7**.
- Remove burner, refer to **Section 16.8**.
- Remove injector bar retaining nuts and separate the injector bar from the burner.
- Remove and renew injectors as required from injector bar.

Note: Make sure that injector size, marked on each injector, is the same as that given in '**Section 1 Technical Data**' for the type of gas being used.

- Assemble the burner in reverse order to removal taking care to engage all parts correctly.

19.25 Ignition electrode assembly, refer to diagram 16.4

Before starting refer to the front of **Section 19 Important information**.

- Remove the front panel, refer to **Section 16.3**.
- Lower the control panel, refer to **Section 16.4**.
- Remove the sealed chamber cover, refer to **Section 16.5**.
- Remove the combustion chamber cover, refer to **Section 16.7**.
- Pull off ignition leads from gas control valve.
- Ease ignition leads through the grommet.
- Undo and remove screws securing electrode assembly onto burner.
- Fit replacement electrode assembly onto burner in reverse order to removal.
- When refitting ensure that the grommet locates and seals correctly.

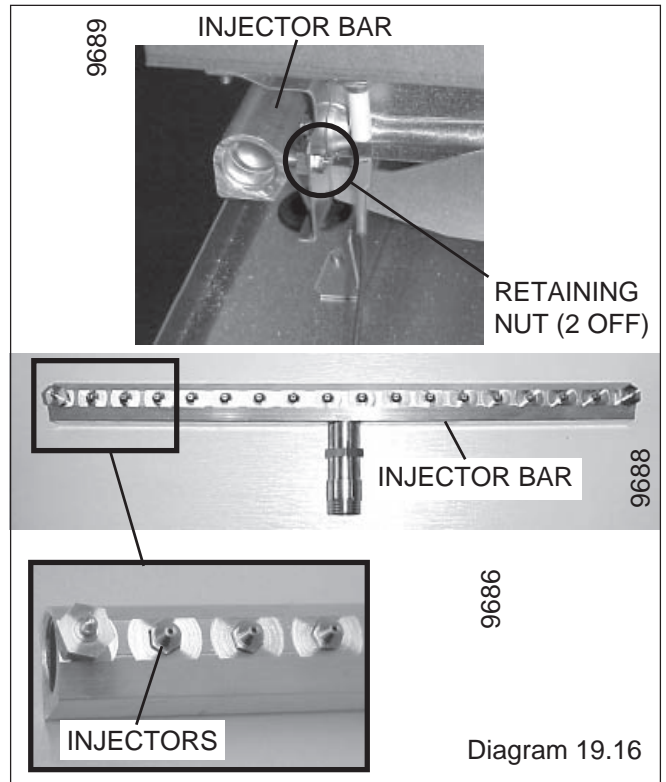

19.26 Flame sense electrode, refer to diagram 16.4

Before starting refer to the front of **Section 19 Important information**.

- Remove the front panel, refer to **Section 16.3**.
- Lower the control panel, refer to **Section 16.4**.
- Remove the sealed chamber cover, refer to **Section 16.5**.
- Remove the combustion chamber cover, refer to **Section 16.7**.
- Pull off flame sense lead from flame sense electrode.
- Undo and remove screws securing flame sense electrode onto burner.
- Fit replacement flame sense electrode onto burner.

19 Replacement of Parts

19.27 User interface board assembly, refer to diagram 19.17.

Before starting refer to the front of **Section 19 Important information**.

- Remove the front panel, refer to **Section 16.3**.
- Lower the control panel, refer to **Section 16.4**.
- Gain access to rear of control panel.
- Unclip side clips and hinge up control panel cover, see **diagram 11.2**.
- Carefully pull off electrical connection from the user interface board to PCB at (B4).
- Remove the two securing screws to release the control panel fascia.
- Remove the two user interface board assembly securing screws to remove the user interface board assembly.
- Fit replacement user interface board.

19.28 Clock-timer, refer to diagrams 19.17 and 19.18.

Before starting refer to the front of **Section 19 Important information**.

- Remove the front panel, refer to **Section 16.3**.
- Lower the control panel, refer to **Section 16.4**.
- Gain access to rear of control panel.
- Unclip side clips and hinge up control panel cover, see **diagram 11.2**.
- Carefully pull off electrical connection from the clock-timer to PCB at (B5).
- Remove the two securing screws to release the control panel fascia.
- Remove the two clock-timer securing screws to remove clock-timer.
- Fit replacement clock-timer.

19.29 Mains power switch, refer to diagram 19.17.

Before starting refer to the front of **Section 19 Important information**.

- Remove the front panel, refer to **Section 16.3**.
- Lower the control panel, refer to **Section 16.4**.
- Gain access to rear of control panel.
- Unclip side clips and hinge up control panel cover, see **diagram 11.2**.
- Slide back and up to remove the mains power switch.
- Carefully pull off electrical connections from the mains power switch.
- Fit replacement mains power switch.

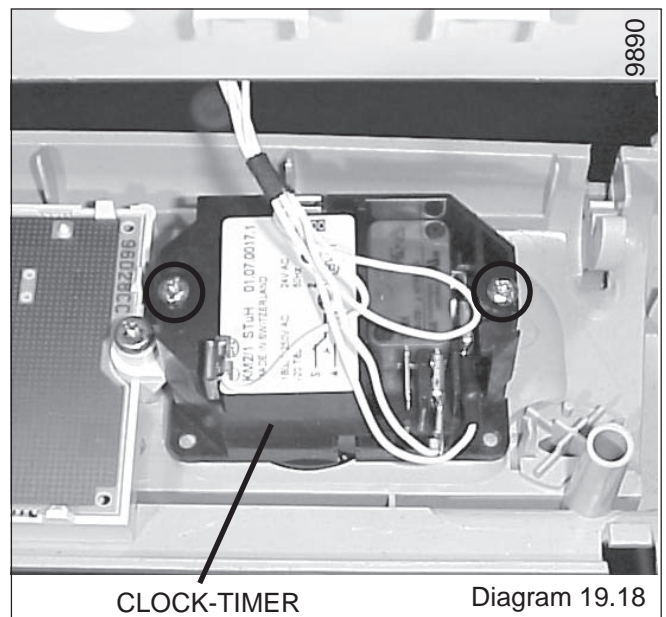
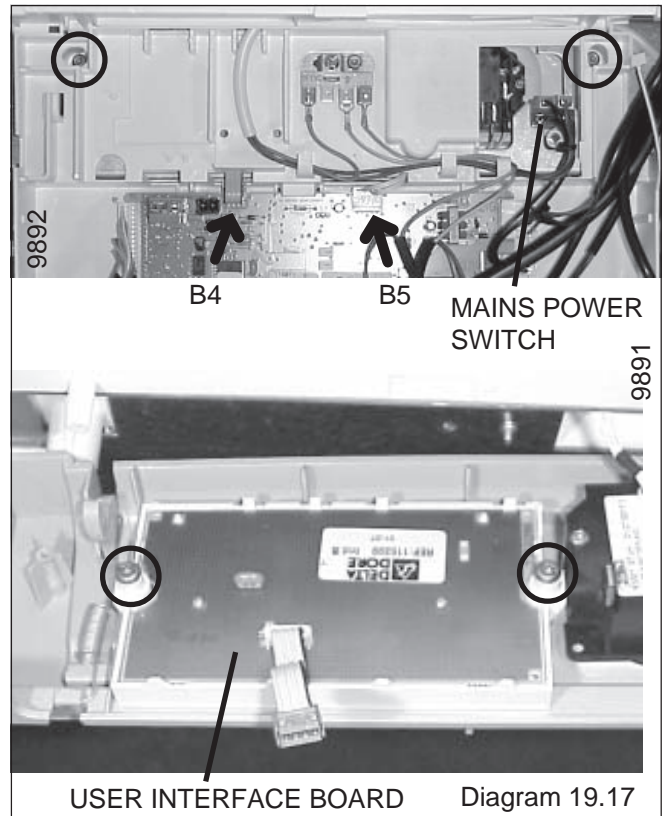

19 Replacement of Parts

19.30 Domestic Hot water storage vessel, refer to diagram 19.19.

For this operation the boiler must be removed from the wall.

Before starting refer to the front of **Section 19 Important information**.

- Drain down central heating and domestic hot water circuit of boiler only, **refer to relevant parts of Sections 16.13 and 19.8**.

Note: It is not necessary to drain down entire heating system to carry out this work.

- Disconnect flue system.
- Remove the base panel, secured with four screws and hooked in at the rear.
- Disconnect boiler pipes onto fixing jig.
- Remove the front panel, **refer to Section 16.3**.
- Lower the control panel, **refer to Section 16.4**.
- Gain access to rear of control panel.
- Unclip side clips and hinge up control panel cover, **see diagram 11.2**.
- Disconnect mains cable and any external controls cables.
- Carefully pull off electrical connection at (H4) from the PCB. Unclip to release the cable back to the storage vessel.
- Remove the sealed chamber cover, **refer to Section 16.4**. Remove the two side panels, **refer to Section 16.6**. Using the two lifting handles positioned bottom left of the controls and to the center right of the combustion chamber lift the boiler off the hanging bracket and away from the wall.
- From rear of boiler, disconnect domestic pipes from the bottom of the storage vessel.
- Disconnect electrical connections from vessel.
- Unclip vessel from boiler frame and remove from boiler.

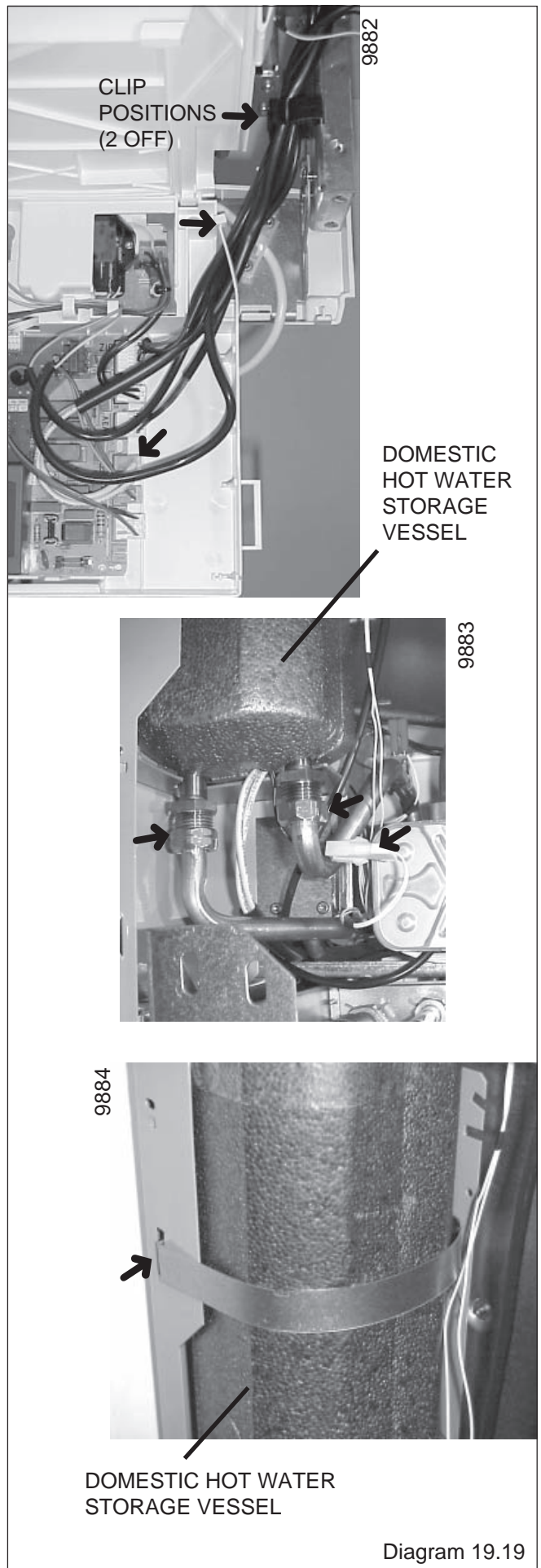

19 Replacement of Parts

19.31 Storage vessel thermistor, refer to diagram 19.20.

For this operation the boiler must be removed from the wall.

Before starting refer to the front of **Section 19 Important information**.

• Drain down central heating and domestic hot water circuit of boiler only, **refer to relevant parts of Sections 16.13 and 19.8**.

Note: It is not necessary to drain down entire heating system to carry out this work.

- Disconnect flue system.
- Remove the base panel, secured with four screws and hooked in at the rear.
- Disconnect boiler pipes onto fixing jig.
- Remove the front panel, **refer to Section 16.3**.
- Lower the control panel, **refer to Section 16.4**.
- Gain access to rear of control panel.
- Unclip side clips and hinge up control panel cover, **see diagram 11.2**.
- Disconnect mains cable and any external controls cables.
- Remove the sealed chamber cover, **refer to Section 16.4**. Remove the two side panels, **refer to Section 16.6**. Using the two lifting handles positioned bottom left of the controls and to the center right of the combustion chamber lift the boiler off the hanging bracket and away from the wall.
- Remove the insulation from around the storage vessel
- Locate thermistor.
- Disconnect the electrical connection to the thermistor.
- Peel off the self adhesive thermistor.
- Clean the surface prior to fitting the replacement thermistor in same position as old thermistor.
- Refit vessel.
- Refit boiler onto fixing jig, tighten all connections ensuring that all sealing washers are fitted before tightening.
- Reconnect flue making sure that all joints are properly connected.

19.32 Storage vessel heating element, refer to diagram 19.21.

For this operation the boiler must be removed from the wall and the storage vessel removed, **refer to Section 19.30**.

- Remove the insulation from around the storage vessel
- Locate heating element.
- Peel off the heating element, secured with self adhesive tape.
- Clean the surface prior to fitting the replacement heating element in same position as old heating element.
- Refit vessel in reverse order to removal.
- Refit boiler onto fixing jig, tighten all connections ensuring that all sealing washers are fitted before tightening.
- Reconnect flue making sure that all joints are properly connected.

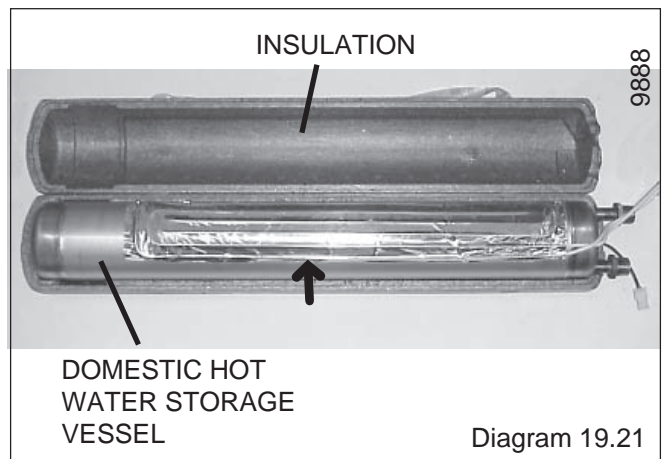
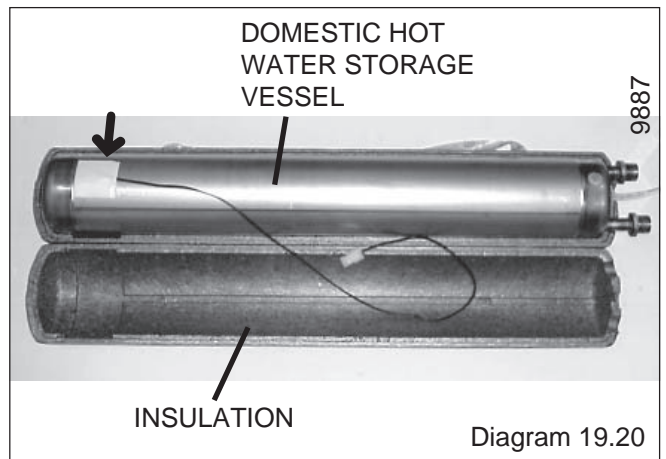

19 Replacement of Parts

19.33 Expansion vessel, refer to diagram

19.22.

For this operation the boiler must be removed from the wall.

Before starting refer to the front of **Section 19 Important information**.

- Drain down central heating and domestic hot water circuit of boiler only, refer to relevant parts of Sections 16.13 and 19.8.

Note: It is not necessary to drain down entire heating system to carry out this work.

- Disconnect flue system.
- Remove the base panel, secured with four screws and hooked in at the rear.
- Disconnect boiler pipes onto fixing jig.
- Remove the front panel, refer to Section 16.3.
- Lower the control panel, refer to Section 16.4.
- Gain access to rear of control panel.
- Unclip side clips and hinge up control panel cover, see diagram 11.2.
- Disconnect mains cable and any external controls cables.
- Remove the sealed chamber cover, refer to Section 16.4. Remove the two side panels, refer to Section 16.6. Using the two lifting handles positioned bottom left of the controls and to the center right of the combustion chamber lift the boiler off the hanging bracket and away from the wall.
- Supporting expansion vessel unscrew and remove expansion vessel retaining nut and screw.
- Remove expansion vessel.
- Fit replacement expansion vessel.

Note: Check that expansion vessel pressure is correct, see 'Section 1 Technical Data'.

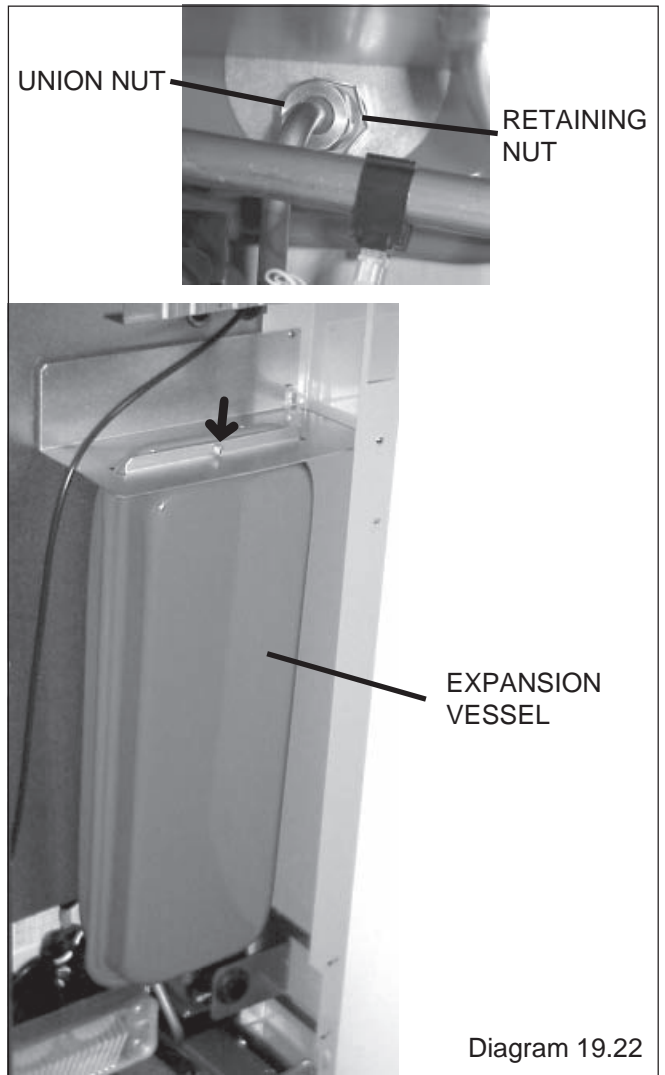

20 Spare Parts

When ordering spare parts, quote the part number and description, stating the appliance model number and serial number from the data label.

Short parts list

No.	Description	Part No.	G. C. No.
1	Domestic hot water thermistor	57213	*****
2	Central heating thermistor	57215	*****
3	Storage vessel thermistor	57250	
4	Fan	57238	
5	Air pressure switch	57237	
6	Domestic water flow sensor	57202	
7	Printed circuit board	57248	
8	Pump	57207	
9	3-way valve head	57206	
10	System pressure sensor	57205	
11	Gas valve module	57079	
12	Central heating safety valve	57228	
13	Domestic safety valve	57229	
14	Overheat thermostat	57212	
15	Ignition electrode	57194	
16	Flame sense electrode	57195	
16	Clock-timer	57245	

Because of our constant endeavour for improvement details may vary slightly from those in the instructions.