



# Windsor & Caress Slimline

**DECORATIVE FUEL EFFECT GAS FIRE**

**Installation, Maintenance & User Instructions**

**Hand these instructions to the user**

**Model No's FSRC\*\*MN, FSRP\*\*MN & FSRD\*\*MN are for use on  
Natural Gas (G20) at a supply pressure of 20 mbar in G.B. / I.E.**

**\*\* denotes trim and fret variant fitted to product**

# CONTENTS

<b>Section 1</b>	<b>Information and Requirements</b>	<b>PAGE</b>
1.0	Appliance Information	3
1.1	Conditions of Installation	4
1.2	Flue and chimney suitability	4
1.3	Fireplace / surround suitability	5
1.4	Shelf position	5
1.5	Chimney inspection	5
1.6	Fire place opening / catchment space	6-7
1.7	Fitting to Chair bricks	8
1.8	Precast Flues	8
1.9	Metal Flue boxes	8
1.10	Hearths	9
1.11	Spillage Monitoring System	9
<b>Section 2</b>	<b>Installation of Fire</b>	
2.1	Unpacking the fire	10
2.2	Installing the fire box	10-16
2.3	Gas tightness and burner pressure	16-17
<b>Section 3</b>	<b>Assembling Fuel Bed and Commissioning</b>	
3.1	Assembling the ceramics and fuel bed (Coal models)	17-19
3.2	Assembling the ceramics and fuelbed (Pebble models)	19-20
3.3	Assembling the ceramics and fuelbed (Driftwood models)	21-26
3.4	Fitting the trim	27
3.5	Fitting the cast trim - Caress Slimline models only	28
3.6	Fitting the fret	29
3.7	Lighting the appliance	29
3.8	Checking for clearance of combustion products	30
<b>Section 4</b>	<b>Maintenance</b>	
4.1	Removal of the Burner Assembly	31
4.2	Removal of the Piezo Igniter	31
4.3	Removal of the Control Tap	32
4.4	Removal of the Thermocouple	32
<b>Section 5</b>	<b>User Instructions Section</b>	
5.1	Conditions of Installation / About Your New Gas Fire	33-34
5.2	Operating the Fire	35
5.3	Assembling the Coal Fuelbed	36-37
5.4	Assembling the Pebble Fuelbed	38-39
5.5	Assembling the Driftwood Fuelbed	40-45
5.6	Cleaning the Fire	46

This appliance is manufactured by :-

BFM Europe Ltd.  
Trentham Lakes,  
Stoke-on-Trent,  
ST4 4TJ

## SECTION 1 INFORMATION AND REQUIREMENTS

### 1.0 APPLIANCE INFORMATION

Model	FSRC**MN, FSRP**MN & FSRD**MN ** denotes trim & fret variant of product
Gas Type	G20
Main injector (1 off)	Size 440
Burner Type	Aeromatic Self Vitiating Tubular Burner
Max. Gross Heat Input :	6.5 kW
Min. Gross Heat Input & Ignition Rate :	2.2 kW
Cold Pressure :	20.0 +/-1.0 mbar
Ignition :	Push-button Piezo
Electrode Spark Gap	4.0mm
Packed Weight (All models with fret)	12.5 kg
Packed Weight (All models with Contemporary Trim)	10.5 kg
Packed Weight (All models with Caress Trim)	17.5 kg

#### **Fire box Dimensions (with trim fitted)**

Width :	(with trim fitted)	510mm
Height :	(with trim fitted)	625mm
Depth :	(from mounting face to rear panel)	120mm

Gas Connection : 8mm Compression (Supplied with fire)

#### **Appliance Efficiency Declaration**

**The efficiency of this appliance has been measured as specified in BS 7977-1 : 2002 and the result is 51%.**

**The gross calorific value of the fuel has been used for this efficiency calculation.**

**The test data from which it has been calculated has been certified by Advantica. The efficiency value may be used in the UK Government's Standard Assessment Procedure (SAP) for energy rating of dwellings.**

# INSTALLATION REQUIREMENTS

## 1.1 CONDITIONS OF INSTALLATION

It is the law that all gas appliances are installed only by a CORGI Registered Installer, in accordance with these installation instructions and the Gas Safety (Installation and Use) Regulations 1998 as amended. Failure to install appliances correctly could lead to prosecution. It is in your own interest and that of safety to comply with the law.

The installation must also be in accordance with all relevant parts of the Local and National Building Regulations where appropriate, the Building Regulations (Scotland Consolidation) issued by the Scottish Development Department, and all applicable requirements of the following British Standard Code of Practice.

1. B.S. 5871 Part 2 Installation of Inset Fuel Effect Gas Fires
2. B.S. 6891 Installation of Gas Pipework
3. B.S. 5440 Parts 1 & 2 Installation of Flues and Ventilation
4. B.S. 1251 Open fire place components
5. B.S. 715 Metal flue pipes for gas appliances
6. B.S. 6461 Part 1 Installation of Chimneys and flues
7. B.S. E.N. 1858 Chimneys Components & Concrete Flue Blocks
8. I.S. 813 : 1996 Domestic Gas Installation (Republic of Ireland)

**No purpose made additional ventilation is normally required for this appliance, when installed in G.B. When installing in I.E. please consult document I.S. 813 : 1996 Domestic Gas Installation, which is issued by the National Standards Authority of Ireland. If installing in Northern Ireland, please consult local building regulations. Any purpose made ventilation must be checked periodically to ensure that it is free from obstruction.**

## 1.2 FLUE AND CHIMNEY SUITABILITY

This appliance is designed for use with conventional brick built or lined chimneys and fabricated flues. It is also suitable for use with pre-cast flue blocks conforming to B.S. E.N. 1858 and metal flue boxes conforming to BS 715. All flues must conform to the following minimum dimensions.

<b>Minimum diameter of circular flues</b>	<b>125 mm (Without Flue Restrictor Fitted)</b>
<b>Minimum effective height of all flue types</b>	<b>3 metres</b>

**When fitting to conventional chimneys or 175mm flues it may be desirable to leave the flue restrictor baffle (supplied) in place to reduce the flue flow and increase the efficiency of the fire. Safe clearance of products must always be checked by carrying out a smoke match test as described.**

### 1.3 FIREPLACE / SURROUND SUITABILITY

The fire must only be installed on a hearth it **must not be installed directly onto carpet or other combustible floor materials.**

The fire is suitable for fitting to non-combustible fire place surrounds and proprietary fire place surrounds with a temperature rating of at least 150°C.

**If a heating appliance is fitted directly against a wall without the use of a fire surround or fire place all combustible material must be removed from behind the trim. Soft wall coverings such as blown vinyl, wall paper etc. could be affected by the rising hot air and scorching and/or discoloration may result. Due consideration should be made to this when installing or decorating.**

### 1.4 SHELF POSITION

The fire may be fitted below a combustible shelf providing there is a minimum distance of 200mm above the top of the fire and the shelf does not project more than 150mm. If the shelf overhangs more than 150mm the distance between the fire and the shelf must be increased by 15mm for every 25mm of additional overhang over 150mm.

### 1.5 FLUE / CHIMNEY INSPECTION

Before commencing installation, a flue or chimney should be inspected to ensure that all the following conditions are satisfied.

1. Check that the chimney / flue only serves one fire place and is clear of any obstruction. Any dampers or register plates must be removed or locked in the open position.
2. Brick/stone built chimneys or any chimney or flue which has been used for an appliance burning fuel other than gas must be thoroughly swept. The base of the chimney / flue must also be thoroughly cleared of debris etc.
3. Any under-floor air supply to the fire place must be completely sealed off.
4. Ensure that the inside of the chimney / flue is in good condition along its length and check that there is no leakage of smoke through the structure of the chimney during and after the smoke pellet test. **With pre-cast flues it is especially important to check the inside of the flue for extruded cement / sealant protruding from the joints between the flue blocks. If present, these should be removed by rodding the flue before proceeding with the installation.**
5. **Using a smoke pellet, check that there is an up-draught in the chimney / flue and that the smoke can be seen issuing from the terminal / chimney pot outside.**

**There must be no leakage of smoke through the structure of the chimney during or after the smoke pellet test and it is important to check inside upstairs rooms adjacent to the chimney / flue.** Check the chimney pot / terminal and general condition of the brickwork or masonry. If the chimney or flue is in poor condition or if there is no up-draught do not proceed with the installation. If there is a history of down-draught conditions with the chimney / flue, a tested and certificated flue terminal or cowl suitable for the relevant flue type should be considered.

6. **A spillage test must always be carried out during commissioning of the appliance.**

### 1.6 FIRE PLACE OPENING AND CHIMNEY CATCHMENT SPACE

The front opening of the fire place must be between 330 and 440 mm wide, and between 550 and 575mm high. If the opening exceeds these dimensions then a surround must be constructed from suitable non-combustible material to produce a correct size opening. Any surround must be suitably sealed to the fire place to prevent leakage. See below in fig.1

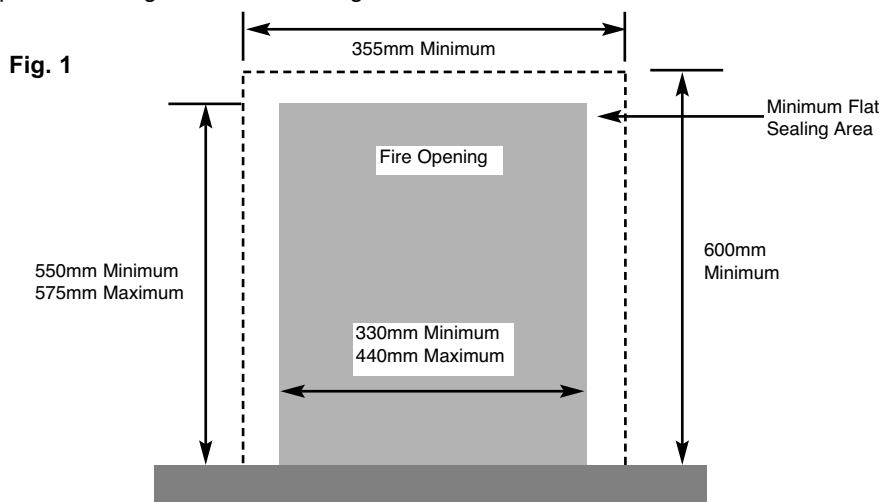

When installing into a brick built chimney, you must ensure that there is sufficient depth to accommodate any debris which may fall from the chimney. This depth must be sufficient to accommodate 12 litres of volumetric space.

**Table A - Installation Depth Requirements for a Flavel Windsor / Caress Slimline being installed into a brick built chimney, requiring 12.0 litres of debris collection volume (fig. 2).**

Opening Width (mm)	Minimum Depth Required (mm)
330 (minimum opening width)	152
340	149
350	146
360	144
370	142
380	139
390	137
400	135
410	132
420	130
430	127
440 (maximum opening width)	125

For example, if the appliance was to be fitted into a 400mm wide opening, the depth required would be 135mm. See fig. 2 below for explanatory diagram.

**Fig. 2**

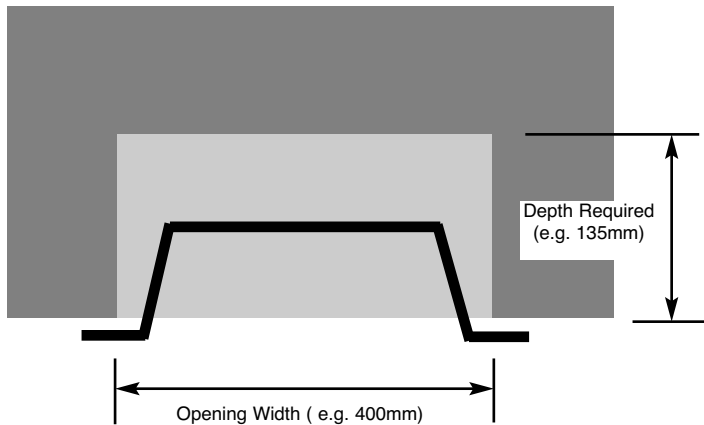

## **1.7 FITTING TO FIREPLACES WITH EXISTING CHAIRBRICKS AND CONVENTIONAL BRICKBUILT CHIMNEYS**

This appliance is suitable for use in fireplaces fitted with an existing chairbrick without the need for removal of the chairbrick, providing the minimum depth of the fireplace exceeds 175mm. If the depth is less than 175mm then the chairbrick must be removed. The fireplace must be checked to ensure that no part of the chairbrick is within 50mm of the flue outlet of the fire when installed.

## **1.8 FITTING TO PRE-CAST FLUE INSTALLATIONS**

**When installing this appliance into pre-cast flues, always ensure that the spigot restrictor baffle has been removed. This is held in place on the spigot by 2 screws**

**To install the fire box in to pre-cast flue starter blocks, there must be at least 125mm from the mounting face of the fire to the rear of the pre-cast flue starter block** to allow sufficient space for debris collection. If this dimension is less than 125mm then a fire surround with a deeper rebate to increase the depth to at least 125mm from the mounting face of the fire. It is important to consider this depth when choosing a fire surround as the thickness of the fire surround must be sufficient to give a total depth of **at least 125 mm to the rear of the starter block**, otherwise there will be insufficient depth. To increase this depth the fire surround may be packed away from the wall using suitable non-combustible board, providing the installation is correctly sealed. If in doubt about the suitability of the fire contact BFM Europe Ltd. for advice before proceeding.

It is important to ensure that the pre-cast flue is in good condition and is free from extruded mortar or sealant from between the flue blocks.

**This appliance has been tested for use in a pre-cast flue block complying with BS EN 1858. In accordance with BS EN 1858, pre-cast flues built with directly plastered faces (front or rear) are not correctly installed as to ensure proper operation with any type of gas fire. In some instances of this flue construction, temperature cracking of surface plaster may occur through no fault of the appliance. An air gap or some form of insulation material should be installed to prevent normal flue temperatures from damaging wall surfaces.**

## **1.9 FITTING TO PRE-FABRICATED TWIN WALL METAL FLUE BOXES**

The appliance may be fitted to twin wall metal flue boxes conforming to the constructional requirements of BS 715, (for example the Selkirk LFE 125 box). The box must have a minimum flue diameter of 125mm internal and minimum internal dimensions of 160mm deep by 580mm high by 350mm wide. There are no maximum dimensional requirements for the box. The top face of the box must be insulated with a minimum thickness of 50mm of non-combustible mineral wool insulation or similar material. The flue box must stand on a non-combustible base of minimum thickness 12mm.



## 1.10 HEARTHES

This appliance must only be installed on to a concrete or non-combustible hearth. The hearth material must be a minimum thickness of 12mm with the top surface at least 50mm above the floor. The hearth must be fitted symmetrically about the fire opening and have a minimum width of 760mm and a minimum projection of 300mm forwards from the fire opening.

## 1.11 SPILLAGE MONITORING SYSTEM

This appliance is fitted with an atmosphere sensing spillage monitoring system in the form of an oxygen sensing burner. This is designed to shut the fire off in the event of a partial or complete blockage of the flue causing a build up of combustion products in the room in which the fire is operated. **The following are important warnings relating to this spillage monitoring system :-**

- 1) The spillage monitoring system must not be adjusted by the installer.
- 2) The spillage monitoring system must not be put out of operation.
- 3) When the spillage monitoring system is exchanged only a complete original manufacturers part may be fitted.

## SECTION 2 INSTALLATION OF FIRE

### 2.1 UNPACKING THE FIRE

Carefully lift the fire out of the carton. Remove the loose item packaging carefully from the front of the appliance. Check the contents as listed :-

#### Packing Check List - Coal Fuelbed Models

- 1off Fire box / burner assembly
- 1off Boxed ceramic base and 7 synthetic coals
- 1off Loose items bag.
- 1off Trim (3 piece or 1 piece dependent upon model chosen)
- 1off Boxed Fret & Ashpan cover (dependent upon model chosen)
- 1off each Installation / User book (Combined)
- 4 off Cast trim mounting brackets and screws - in loose items pack
- 1 off Cast Trim (Caress Slimline models only)

#### Packing Check List - Pebble & Driftwood Fuelbed Models

- 1off Fire box / burner assembly
- 1off Boxed ceramic base and 7 synthetic pebbles (4 large, 3 small) or driftwood pieces
- 1off Loose items bag.
- 1off Chrome Effect Trim / Ashpan
  
- 1off each Installation / User book (Combined)

### 2.2 INSTALLING THE FIRE BOX

Establish which type of flue you are intending to install the fire in to :-

**225 x 225mm (9 inch x 9 inch) brick built chimneys**

**175mm (7 inch) diameter lined brick or stone flue, or insulated pre-fabricated metal flue box to B.S. 715.**

**When installing into 125mm (5 inch) diameter lined brick or stone flue, or insulated pre-fabricated metal flue box to B.S. 715 and pre-cast flues the restrictor baffle must not be fitted.**

**A spillage test must always be carried out to check satisfactory clearance of flue products, regardless of the type of flue the appliance is being fitted to.**

**Proceed as follows :-**

- a) Remove the two screws at the bottom of the control panel. See fig. 3 below

**Fig. 3**

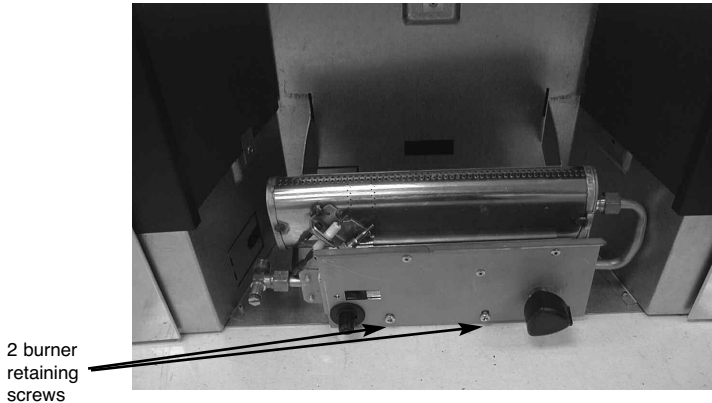

- b) The base of the burner unit can now be lifted, lift the two retaining tabs on the burner brackets from the back of the firebox, allowing the burner to be removed. See fig. 4 below

**Fig. 4**

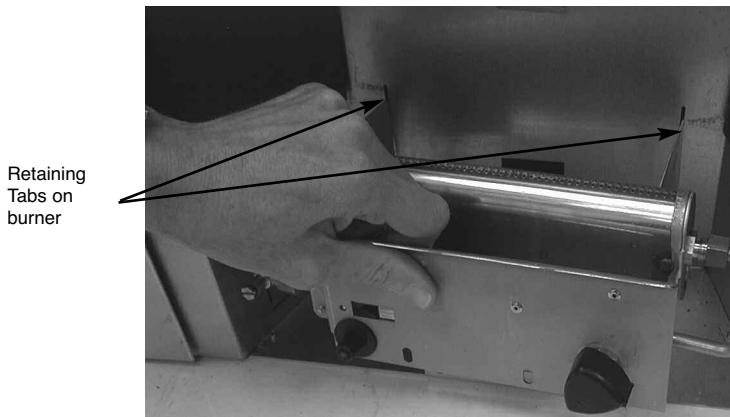

- c) Ensure that the hearth is protected from damage and carefully lift the fire box into the fire opening, then slide it back into position. Check that the fire box flange fits flush to the sealing face of the fire surround or wall with no gaps present.



## **IMPORTANT : Sealing of the Gas Inlet Apertures**

In line with current CORGI regulations, **it is imperative that the gas supply inlet aperture that is utilised during the installation is sealed with the grommet as supplied in the loose items pack.** The product is manufactured with 3 knock out gas inlets in the firebox wrap to allow a left hand, right hand or rear gas inlet supply to the inlet elbow. Using a hammer and a blunt chisel, remove the inlet aperture selected and then seal with the grommet supplied. To provide access for the gas supply pipe, cut the grommet with a sharp knife. Failure to seal the inlet apertures could lead to flame reversal, which in turn will damage the burner and control systems of the product.

Fig. 6 below shows a correctly sealed installation.

**Fig. 6**

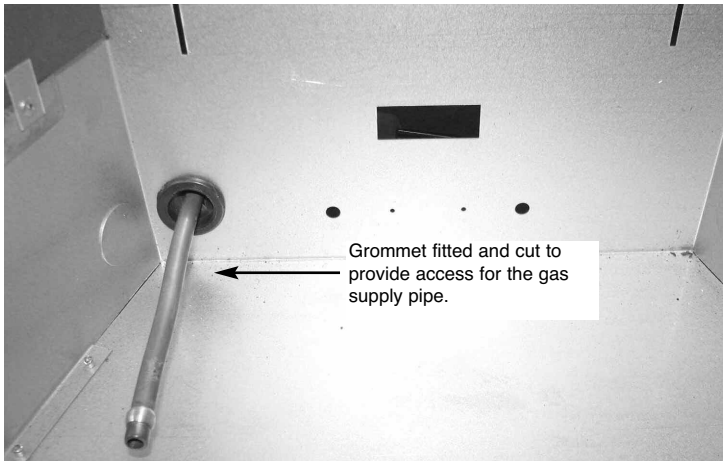

## ***PLEASE NOTE :-***

**BFM EUROPE LTD. WILL NOT BE LIABLE FOR GUARANTEE CLAIMS THAT ARE AS A DIRECT RESULT OF THE GAS INLET APERTURE NOT BEING CORRECTLY SEALED WITH THE GROMMET PROVIDED.**

There is a choice of methods of fixing the firebox which are provided to enable the installer to deal with any type of installation.

**The preferred method of fixing which is suitable for almost all situations is the cable fixing method which is described in the following section in detail.**

The fire may be secured using the cable method as described below, or alternatively, in installations where the cable method is not suitable (eg. loose masonry in rear of fire opening) the fire box can be directly secured to the fire surround using the screws and rawlplugs provided.

To fit using the **preferred** cable method proceed as follows-

- e) Mark out and drill 4 off No 14 (7mm) holes in the back face of the fire opening in the positions shown below in fig. 7

**Fig. 7**

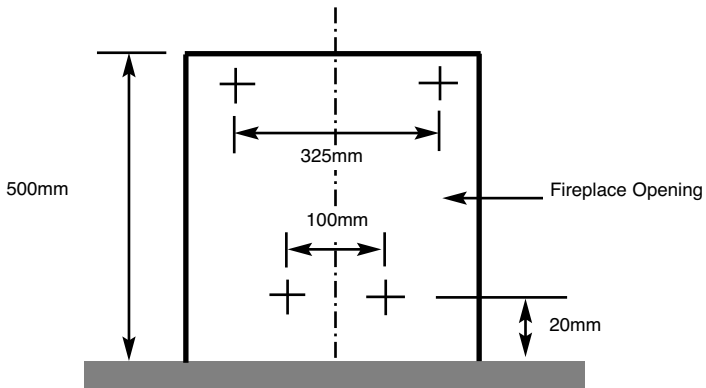

Fit the wallplugs provided and screw the fixing eyes securely into the rear of the fire opening. If the clearance at the rear of the fire is at the minimum specified for a precast flue application, it may be necessary to bend over the lower fixing eyes after screwing them fully in to the rear of a pre-cast starter block.

- f) Uncoil the two fire fixing cables and thread one end of each of the cables through one of the two holes on each side of the flue outlet shroud.

- g) Position the fire carefully on the (protected) surface of the hearth and reach into the fire opening. Thread each of the cables vertically downwards through the pair of fixing eyes on the same side of the fire. Thread the free end of the cables through the corresponding circular hole on each side of the lower rear of the fire. Carefully slide the fire box back into the fire opening and pull both cables tight.
- h) Thread a tensioning screw over each of the cables and ensure that the tensioning nut is screwed fully up against the hexagon shoulder of the tensioning screw (this provides maximum travel for the tensioning nut).
- i) Fit a screwed nipple on to each of the cables and pull hand tight up against the tensioning screw, then secure each nipple with a flat bladed screwdriver. See fig. 8 below

**Fig. 8**

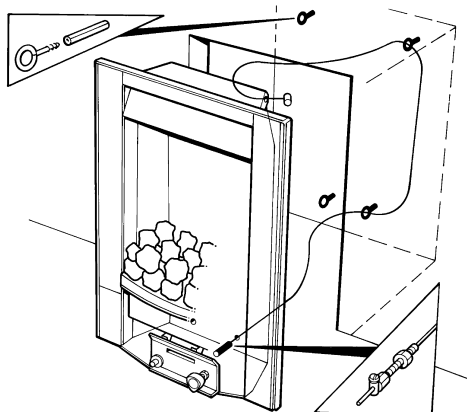

- j) Evenly tighten the tensioning nuts to tension both cables and pull the fire snugly against the wall. Do not overtighten, it is only necessary to pull the seal up against the sealing face of the wall, it does not need to be compressed. Check that there are no gaps behind the seal.
- k) With the fire securely in place, if a concealed gas connection has been made through either of the access holes in the sides or rear of the fire, the holes should be closed around the pipe to prevent leakage of air through the gap around the pipe.
- l) Refit the burner. Fit the two retaining screws and check that the burner is correctly locked into position.

- m) **Before making the final gas connection, thoroughly purge the gas supply pipework to remove all foreign matter, otherwise serious damage may be caused to the gas control valve on the fire.**

The other firebox fixing method is as follows :-

In installations where the cable method is not suitable (e.g. loose masonry in rear of fire opening) the firebox can be secured to the fire surround using four screws and wall plugs provided. Below (fig.9) is a diagram to indicate the hole centre positions available on the firebox to facilitate the screw fixing to the fireplace / surround.

**Fig. 9**

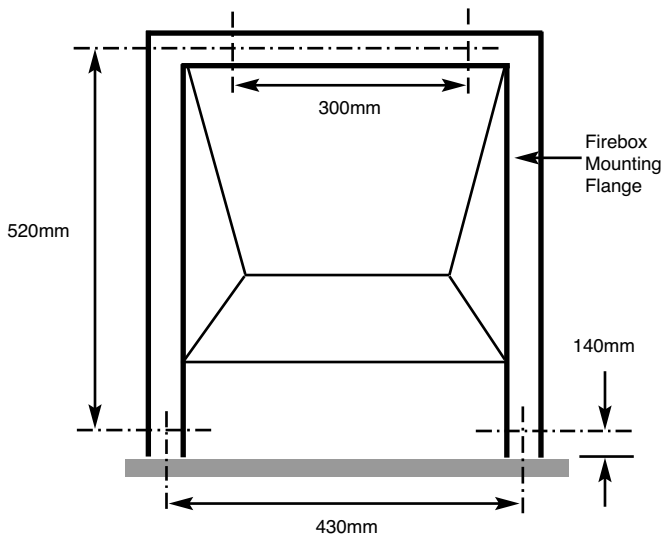

### **2.3 GAS TIGHTNESS AND INLET PRESSURE**

- Remove the pressure test point screw from the inlet elbow and fit a manometer.
- Turn on the main gas supply and carry out a gas tightness test.
- Depress the control knob and turn anti-clockwise to the position marked ignition / low. Hold in the control knob for a few seconds to purge the pipe work then press the igniter button. The burner should light,



continue to hold the control knob for a few seconds then turn to the full-on position.

- d) Check that the gas pressure is **20.0 mbar (+/- 1.0mbar) 8.0 in w.g.(+/- 0.4 in w.g.)**
- e) Turn off the fire, remove the manometer and refit the pressure test point screw. Check the pressure test point screw for gas tightness with the appliance turned on using a suitable leak detection fluid or detector.

### SECTION 3 ASSEMBLING FUEL-BED AND COMMISSIONING

#### 3.1 ASSEMBLING THE FUEL-BED - Coal Fuelbed Model

- a) Place the fuelbed base centrally on to the fuelbed support and push fully backwards to the rear face of the fibre boards **Make sure that the fuelbed base is located centrally in the fire box.** See Fig. 10 below.

**Fig. 10**



- b) Position the front row of four loose coals along behind the first row of coals, ensuring that the flame paths as indicated are not interrupted. See Fig. 11 below

**Fig. 11**



- c) Fit the remaining three coals onto the ribs in the fuelbed as shown below, ensuring that the rear flame paths as indicated are not interrupted. See Fig. 12 below.

**Fig. 12**

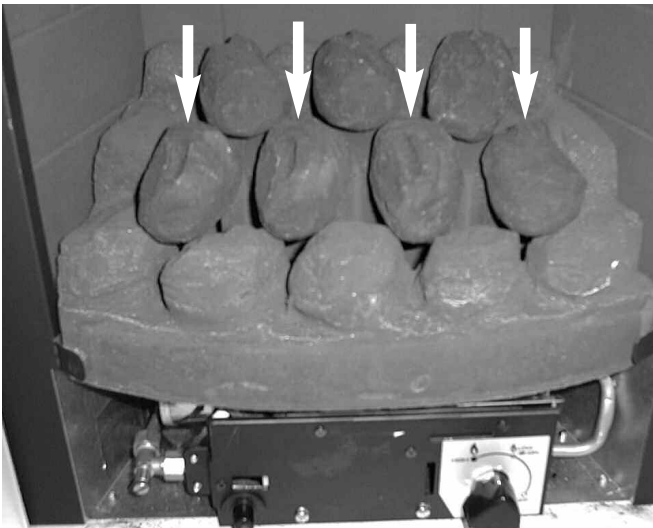

The exact position and fit of the coals may be finely adjusted to give the best appearance.

**Warning :** Use only the coal set supplied with the fire. When replacing the coals remove the old coals and discard them. Fit a complete set of coals of the correct type. Do not fit additional coals or any coals other than a genuine replacement set.

### 3.2 ASSEMBLING THE FUEL-BED - Pebble Fuelbed Model

- a) Place the fuelbed base centrally on to the fuelbed support and push fully backwards to the rear face of the fibre boards **Make sure that the fuelbed base is located centrally in the fire box.** See Fig. 13 below

**Fig. 13**



- b) Position the front row of four large loose pebbles along behind the first row of pebbles, ensuring that the flame paths as indicated are not interrupted. See Fig. 14 below

**Fig. 14**

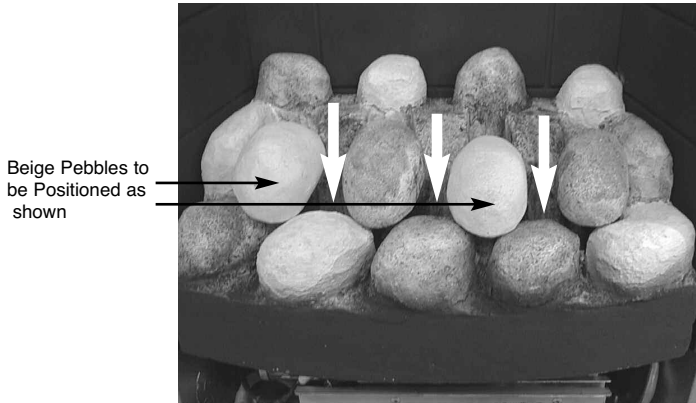

- c) Fit the three small pebbles onto the ribs in the fuelbed as shown below, ensuring that the rear flame paths as indicated are not interrupted. See Fig. 15 below.

**Fig. 15**

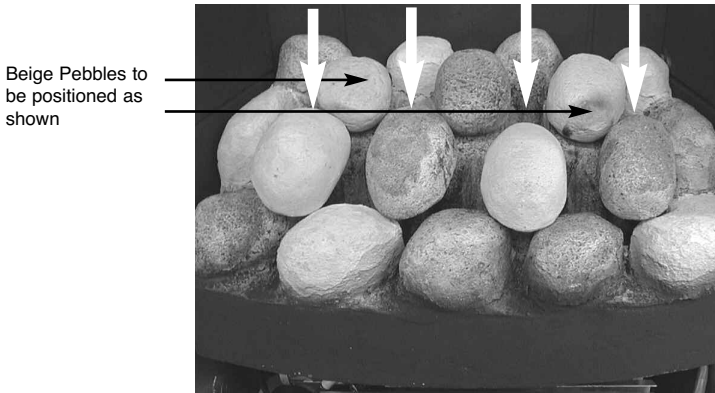

### 3.3 ASSEMBLING THE FUEL-BED - Driftwood Fuelbed Model

- a) Place the fuelbed base centrally on to the fuelbed support and push fully backwards to the rear face of the fibre boards **Make sure that the fuelbed base is located centrally in the fire box.** See Fig. 16 below

Fig. 16



- b) Position the piece of driftwood with the letter “A” stamped onto the bottom face of it in the position at the left-hand side of the fuelbed matrix. Ensure the positioning grooves as shown are on the top face of the piece of driftwood. See Fig. 17 below.

Fig. 17

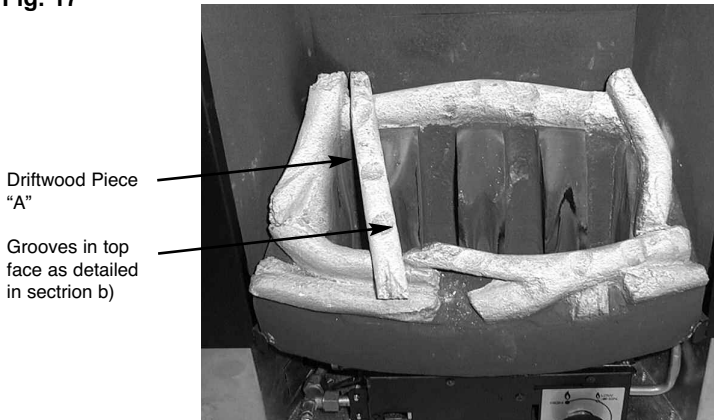

- c) Position the piece of driftwood with the letter “B” stamped onto the bottom face of it in the position at the centre of the fuelbed matrix. Ensure the positioning grooves as shown are on the top face of the piece of driftwood. See Fig. 18 below.

**Fig. 18**

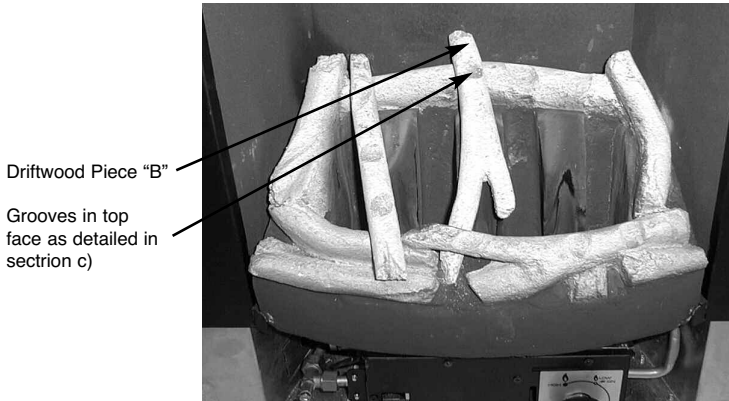

- d) Position the piece of driftwood with the letter “C” stamped onto the bottom face of it in the position at the right-hand side of the fuelbed matrix. Ensure the positioning grooves as shown are on the top face of the piece of driftwood. See Fig. 19 below.

**Fig. 19**

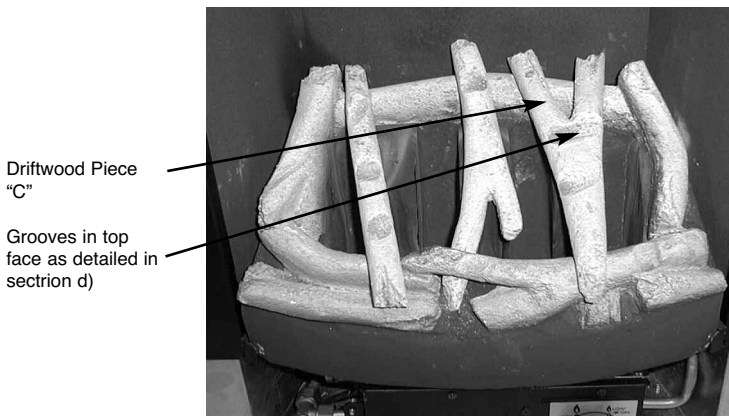

- e) Position the piece of driftwood with the letter “D” stamped onto the bottom face of it in the position at the right-hand side of the fuelbed matrix. Ensure this piece of driftwood is located into the groove in the front right hand side of the fuelbed matrix . See Fig. 20 below.

**Fig. 20**

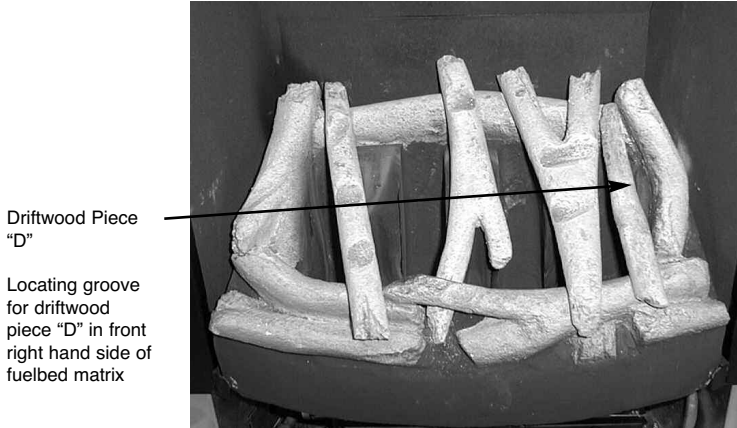

- f) Position the piece of driftwood with the letter “E” stamped onto the bottom face of it in the position at the front centre of the fuelbed matrix. Ensure this piece of driftwood is located into the groove on driftwood piece “C” . See Fig. 21 below.

**Fig. 21**



- g) Position the piece of driftwood with the letter “F” stamped onto the bottom face of it in the across the centre of the driftwood pieces “A”, “B” & “C”. Ensure this piece of driftwood is located into the groove’s on the top face of driftwood pieces A, B & C . See Fig. 22 below.

**Fig. 22**

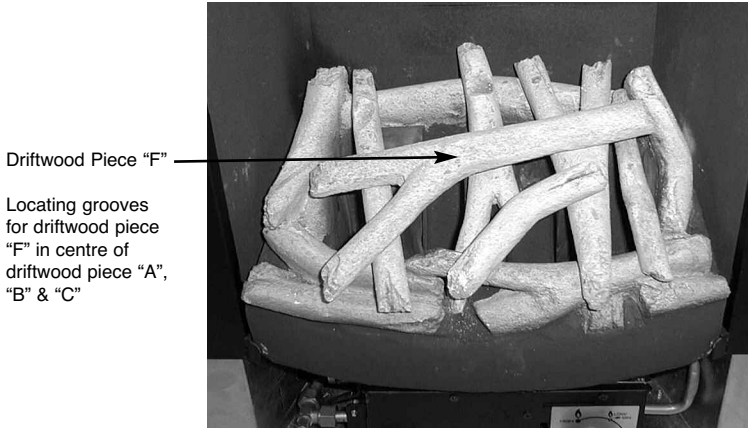

- h) Position the piece of driftwood with the letter “G” stamped onto the bottom face of it in the across the left hand side of the fuelbed matrix, locating into the grooves on driftwood pieces “A” & “B”. See Fig. 23 below.

**Fig. 23**

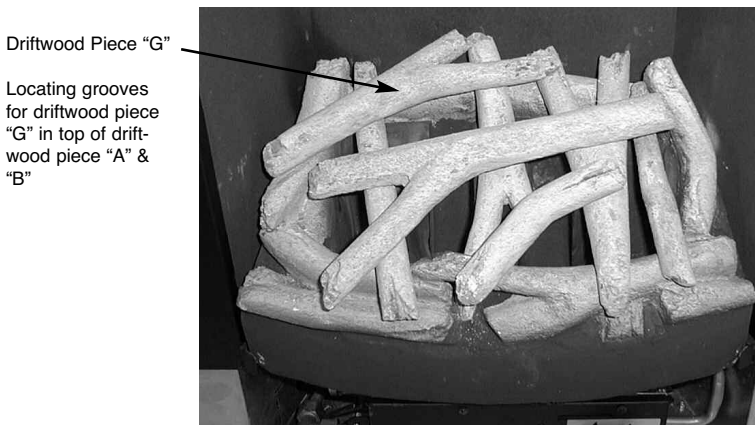



**Warning : Use only the driftwood set supplied with the fire. When replacing the driftwood remove the old driftwood pieces and discard them. Fit a complete set of driftwood pieces of the correct type. Do not fit additional driftwood or any driftwood pieces other than a genuine replacement set.**

**THE FOLLOWING STATEMENT IS APPLICABLE TO ALL FUEL-BED TYPES**

**This appliance uses fuel effect pieces containing Refractory Ceramic Fibres (R.C.F.), which are man-made vitreous silicate fibres. Excessive exposure to these materials may cause temporary irritation to eyes, skin and respiratory tract. Consequently, it makes sense to take care when handling these articles to ensure that the release of dust is kept to a minimum. To ensure that the release of fibres from these R.C.F. articles is kept to a minimum, during installation & servicing we recommend that you use a HEPA filtered vacuum to remove any dust and soot accumulated in and around the fire, before and after working on the fire. When replacing these articles we recommend that the replaced items are not broken up, but are sealed within a heavy duty polythene bag, clearly labelled as “RCF waste”. This is not classified as “hazardous waste” and may be disposed of at a tipping site licensed for the disposal of industrial waste. Protective clothing is not required when handling these articles, but we do recommend you follow the normal hygiene rules of not smoking, eating or drinking in the work area, and always wash your hands before eating or drinking.**

**This appliance does not contain any component manufactured from asbestos or asbestos related products.**

**IMPORTANT INFORMATION REGARDING FUELBED POSITION ON COAL, PEBBLE & DRIFTWOOD MODELS.**

- d) Before continuing with the installation, ensure that the fuelbed is located behind the locating tabs as shown below in Fig. 24, not on top of the locating tabs as shown in Fig. 25

Fig. 24 - Shows correct location of fuelbed

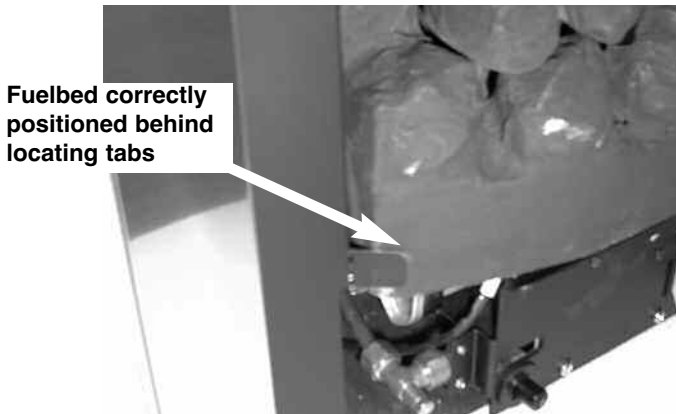
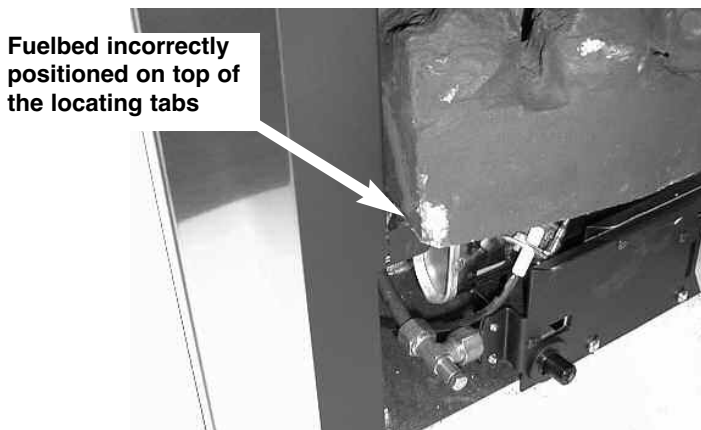

Fig. 25 - Shows incorrect location of fuelbed



**The exact position and fit of the pebbles may be finely adjusted to give the best appearance.**

**Warning : Use only the pebble set supplied with the fire. When replacing the pebbles remove the old pebbles and discard them. Fit a complete set of pebbles of the correct type. Do not fit additional pebbles or any pebbles other than a genuine replacement set.**

### **3.4 FITTING THE TRIM**

#### **Models supplied with three piece trim**

- a) Fit the 2 side pieces of the trim by overlapping the lips of the trim over the side lips of the firebox, and securing with the magnets provided
- b) Fit the top piece of the trim by overlapping the lips of the trim over the lips of the firebox and over the 2 side trims.

#### **Models supplied with one piece trim**

- a) Fit the outer trim assembly to the firebox with the magnets provided.

#### **PEBBLE & DRIFTWOOD MODELS**

- a) Fit the outer trim assembly to the firebox with the magnets provided. NB. The fret is a loose item and located beneath the trim assembly.

### 3.5 FITTING THE TRIM - CARESS MODELS ONLY

- a) Fit the 4 off mounting brackets supplied with the fire in the loose items pack to the rear face of the Cast-Iron Trim as shown below in Fig. 26

Fig. 26

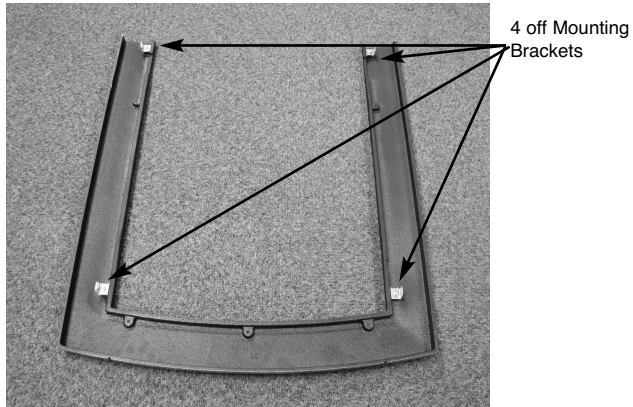

- b) Fit the fascia to the firebox by hooking the mounting brackets into the slots on the firebox as indicated in Fig. 27

Fig. 27

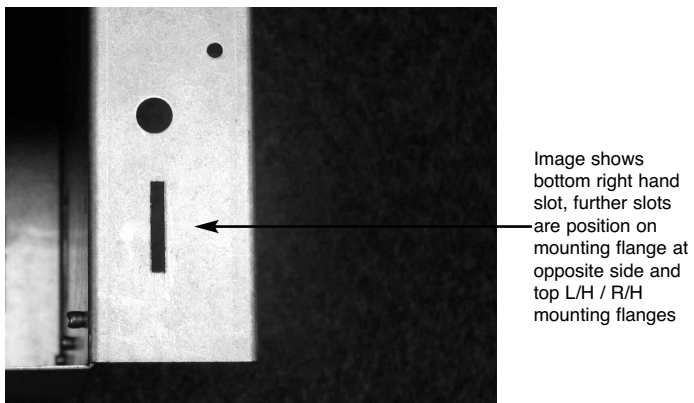

### **3.6 FITTING THE FRET (COAL MODELS ONLY)**

- a) Remove the fret & ashpan cover from the packaging.
- b) Place fret up to the front radiused section of the fuelbed, taking care not to move coal positions.
- c) Place ashpan cover under fret assembly and centralise.

**NOTE :** Some models in this range are not supplied with a fret from the factory, therefore please consult your local retailer for fitting advice on the type of fret supplied with these models.

### **3.7 LIGHTING THE APPLIANCE (All models)**

- a) Turn on the gas isolation tap.
- b) Depress the control knob and turn anti-clockwise to the position marked ignition / low rate. Hold in the control knob for a few seconds to purge the pipe work.
- c) Continue to hold-in the control knob and press the igniter button. If the burner does not light, continue to press the igniter button until ignition occurs. Continue to hold the control knob for a minimum of 20 seconds to allow the thermocouple to heat up, if the burner goes out when the control knob is released, repeat the lighting sequence.
- d) Turn the control knob in the anti-clockwise direction to the high position and the gas rate will increase to high rate (6.5 kW)
- e) Turn the control knob clockwise to the low position and the gas input will be reduced to the minimum setting (2.2 kW)
- f) Slightly depress the control knob and turn to the off position, the burner will now be extinguished.

**WARNING :** If the fire goes out for any reason or is turned off and it is necessary to re-light the fire it is important to allow the fire to cool for 3 minutes before attempting to re-light it.

### 3.8 CHECKING FOR CLEARANCE OF COMBUSTION PRODUCTS

- a) Close all doors and windows in the room.
- b) Light the fire and allow to run for approximately 5 minutes on high position.
- c) After approximately 5 minutes hold a smoke match just inside and below the centre of the lower front edge of the top of the fire. (It is recommended that a suitable smoke match holder is used when checking for clearance of combustion products). All smoke generated should be drawn back into the flue. If slight spillage occurs or if in doubt, repeat the test after a further 5-10 minutes. **If the test indicates that spillage is occurring and the flue restrictor baffle has been fitted, it should be removed and the test repeated after the fire has cooled.**
- d) If spillage persists, the flue is not functioning correctly and a fault exists. If, after investigation the fault cannot be traced and rectified, the fire must be disconnected from the gas supply and expert advice obtained.
- e) If there is an extractor fan fitted anywhere in the vicinity of the appliance, or in adjacent rooms the spillage test should be repeated with the fan running on maximum and all interconnecting doors open.
- f) After ensuring that the fire is safe to use it should be left on high position to fully warm up. During this time a slight odour may be noticed, this is due to the "newness" of the fire and will soon disappear. At this stage any minor adjustments to the pebbles should be made using suitable long handled tongs and taking care not to damage the pebbles.  
Finally, hand the Installation and Maintenance Instructions and the Users Instructions over to the customer and explain the operation of the fire.

## SECTION 4 MAINTENANCE

### **Servicing Notes**

Servicing should be carried out annually by a competent person such as a CORGI registered engineer. **This is a condition of the Flavel guarantee schemes.**

The service should include visually checking the chimney and fire opening for accumulations of debris and a smoke test to check for a positive up-draught in the chimney.

The condition of the coals should be checked and **if necessary the whole set should be replaced with a genuine replacement set.**

The burner assembly is designed to be removed as a complete unit for ease of access. **After any servicing work a gas tightness check must always be carried out. All sections apply for both coal, pebble & driftwood fuelbed model variants.**

### **For Diagrams refer to Section 2**

#### **4.1 Removing the burner assembly from the fire.**

4.1.1 Prepare work area (lay down dust sheets etc.)

4.1.2 Remove the magnetic or cast trim. Remove the fret / ash pan cover or contemporary trim out of the way and put them in a safe location. Remove the loose coals, pebbles or driftwood from the fuel bed. Remove the fuelbed matrix.

4.1.3 Isolate the gas supply and remove the inlet pipe from the appliance inlet elbow. Unscrew and remove the two screws which retain the burner at the base. Lift the burner retaining tabs from the rear of the firebox & remove the burner assembly from the fire.

4.1.4 To refit the burner assembly. Push the retaining tabs into the rear panel of the firebox and secure the burner at the base of the control panel with two screws. Refit the gas supply pipe and carry out a gas tightness test. Refit the burner heat shield then refit the coals, driftwood or pebbles referring to section 3 for the correct layout. The trim and ash pan cover or contemporary trim can now be re-positioned.

#### **4.2 Removing the Piezo Igniter**

4.2.1 Remove the burner assembly as in section 4.1

4.2.2 Disconnect the ignition lead from the piezo and unscrew the retaining nut on the rear of the control panel. Withdraw the piezo from the front of the control panel. Re-assemble in reverse order and carry out a gas tightness test.

### **4.3 Removing the Control Tap from the fire.**

- 4.3.1 Remove the burner assembly as in section 4.1.
- 4.3.2 Pull the control knob off the control tap spindle.
- 4.3.3 Loosen and remove the two gas pipe retaining nuts from the control tap and release the ends of the gas pipes from the control tap body. Remove the push in thermocouple from the end of the control tap.
- 4.3.4 Unscrew the control tap locknut from the front of the control panel and remove the control tap.
- 4.3.5 To refit a control tap, reassemble in reverse order noting that the control tap locates with a flat in the control panel. Carry out a gas tightness test after re-assembly.

### **4.4 Removing the Thermocouple**

- 4.4.1 Remove the burner assembly as in section 4.1
- 4.4.2 Remove the push in thermocouple from the end of the control tap and and remove the thermocouple retaining nut from the mounting bracket on the burner assembly.
- 4.4.3 Re-assemble in reverse order and carry out a gas tightness test.

## **PARTS SHORTLIST**

Replacement of any other parts must be carried out by a competent person such as a CORGI registered gas installer. The part numbers of the main replaceable parts are as follows, these are available from your local Flavel Stockist, whose details can be found on the BFM Europe website, in the “stockist” section.

Coal Pack	B-67050	Coal Fuelbed Matrix	B-67040
Pebble Pack	B-68240	Pebble Fuelbed Matrix	B-68230
L/H Fibre Board (Plain)	B-67550	L/H Fibre Board (Brick Back)	B-68170
R/H Fibre Board (Plain)	B-67560	R/H Fibre Board (Brick Back)	B-68160
Lower Fibre Board (Plain)	B-67540	Lower Rear Fibre Board	B-68150
Upp. Rear Fibre Board (Plain)	B-67530	Upper Rear Fibre Board	B-68140
Gas Valve	B-67090	Driftwood Fuelbed Matrix	B-81160
Burner Engine	B-67890	Driftwood Pack	B-81170
Ignition Wire	B-67910		



## SECTION FIVE - USER INSTRUCTIONS

### 5.1 Installation Information

#### Conditions of Installation

It is the law that all gas appliances are installed only by a competent (e.g. CORGI Registered) Installer, in accordance with the installation instructions and the Gas Safety (Installation and Use) Regulations 1998. Failure to install appliances correctly could lead to prosecution. It is in your own interest and that of safety to comply with the law.

The fire may be fitted below a combustible shelf provided that the shelf is at least 200mm above the top of the appliance and the depth of the shelf does not exceed 150mm.

The fire may be installed below combustible shelves which exceed 150mm deep providing that the clearance above the fire is increased by 15mm for each 25mm of additional overhang in excess of 150mm.

**No purpose made additional ventilation is normally required for this appliance when installed in G.B. When installed I.E. please consult document I.S. 813 : 1996 Domestic Gas Installation which is issued by the National Standards Authority of Ireland. Any purpose made ventilation should be checked periodically to ensure that it is free from obstruction.**

If the chimney or flue has been previously used by appliances burning fuels other than gas they must be swept prior to the installation of this fire.

If this appliance is fitted directly on to a wall without the use of a fireplace or surround, soft wall coverings such as wallpaper, blown vinyl etc. could be affected by the heat and hot air and may discolour or scorch. This should be considered when installing or decorating.

The Model number of this appliance is as stated on the rating plate affixed to the control panel of the fire and the appliance is manufactured by:-

BFM Europe Ltd.  
Trentham Lakes  
Stoke on Trent  
ST4 4TJ

## About your Flavel Windsor

The Flavel Windsor range of coal, pebble & driftwood fuel-bed gas fires incorporates a unique and highly developed fuel bed which gives the realism of a loose coal or pebble layout combined with realistic flames and glow. The use of durable ceramic material in the construction of the fuel-bed components ensures long and trouble free operation.

When first using the new fire a slight smell may be noticed. This is due to starch used in the manufacture of the soft ceramic coals or pebbles, it is non-toxic and will soon disappear.

Please take the time to fully read these instructions as you will then be able to obtain the most effective and safe operation of your fire.

## IMPORTANT SAFETY INFORMATION

### WARNING

**This appliance has a naked flame and as with all heating appliances a fire-guard should be used for the protection of children, the elderly and infirm. Fireguards should conform to B.S. 8423 : 2002 (Fireguards for use with gas heating appliances).**

It is important that this appliance is serviced at least once a year by a CORGI registered gas installer and that during the service the fire is removed from the fire opening and the chimney or flue visually checked for fallen debris or blockages which must be removed. The chimney should also be checked to ensure clearance of flue products. **These are conditions of the manufacturers guarantee. After installation or during servicing a spillage test must always be carried out.**

Rubbish of any type must NEVER be thrown onto the fuel-bed, this could affect safe operation and damage the fire.

Any debris or deposits should be removed from the fuel-bed from time to time. This may be carried out by referring to the cleaning section as described later in this book.

Only the correct number and type of pebbles or coals must be used and only complete and genuine replacement sets must be sourced from BFM Europe Ltd. The appliance must only be used with the coal or pebble set supplied and must not be used with other coals or pebbles.

Always keep furniture and combustible materials well clear of the fire and never dry clothing or items either on or near to the fire. Never use aerosols or flammable cleaning products near to the fire when it is in use.

**The ceramic fuel-bed remains hot for a considerable period after use and sufficient time should be allowed for the fire to cool before cleaning etc. The fire must only be operated with the trim and fret supplied with the fire.**

## **5.2 Operating the Fire**

The controls are located behind the ashpan cover which is situated below the fret or contemporary ashpan cover. The controls, comprise a control valve to adjust the gas flow and a push button piezo igniter. To light the fire proceed as follows:-

- 1) Depress the control knob and turn anti-clockwise to the position marked ignition rate. Hold in the control knob for a few seconds to allow the gas to reach the burner.
- 2) Continue to hold-in the control knob and press the igniter button. If the burner does not light, continue to press the igniter button until ignition occurs. When the pilot has lit, continue to hold the control knob in for a minimum of 20 seconds to allow the thermocouple to heat up, if the burner goes out when the control knob is released, repeat the lighting sequence.

In the unlikely event of a failure of the igniter, the fire can be lit as follows :- Depress the control knob and turn anti-clockwise to the position marked ignition rate. Hold in the control knob for a few seconds to allow the gas to reach the burner. Insert the tip of a lit taper in below the fuelbed ceramic matrix above the thermocouple tip. This will light the main burner at low rate.

- 3) After lighting, turn the control knob in the anti-clockwise direction to the high position. It is recommended that for most efficient performance the fire is allowed to warm up for a few minutes with the gas control on maximum.
- 4) The gas control can be turned clockwise from the maximum position to give the desired heat output.

### **WARNING**

**If the fire goes out for any reason or is turned off and it is necessary to re-light the fire it is important to allow the fire to cool for 3 minutes before attempting to re-light it.**

### **SPILLAGE MONITORING SYSTEM**

This appliance is fitted with a spillage monitoring system which shuts down the fire if the evacuation of combustion products from the fire is affected by a partially or fully blocked flue. If this system operates the fire will go out. If this occurs, leave the fire for at least three minutes then follow the lighting procedure as described in the previous section. **In the event of repeated operation a CORGI registered gas installer must be called to investigate and rectify the cause.**

### 5.3 ASSEMBLING THE FUEL-BED - Coal Fuelbed Model

- a) Place the fuelbed base centrally on to the fuelbed support and push fully backwards to the rear face of the fibre boards **Make sure that the fuelbed base is located centrally in the fire box.** See Fig. 26 below.

Fig. 26



- b) Position the front row of four loose coals along behind the first row of coals, ensuring that the flame paths as indicated are not interrupted. See Fig. 27 below

Fig. 27

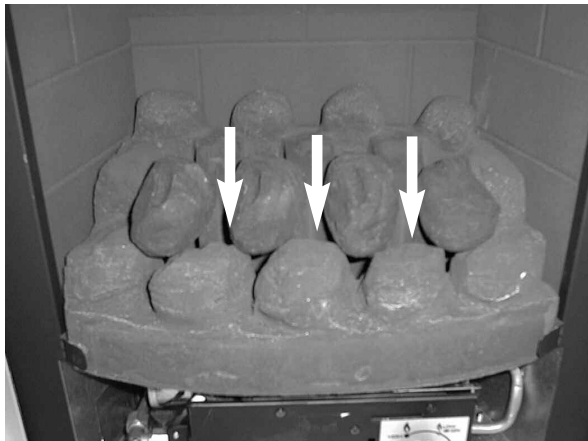

- c) Fit the remaining three coals onto the ribs in the fuelbed as shown below, ensuring that the rear flame paths as indicated are not interrupted. See Fig. 28 below.

**Fig. 28**

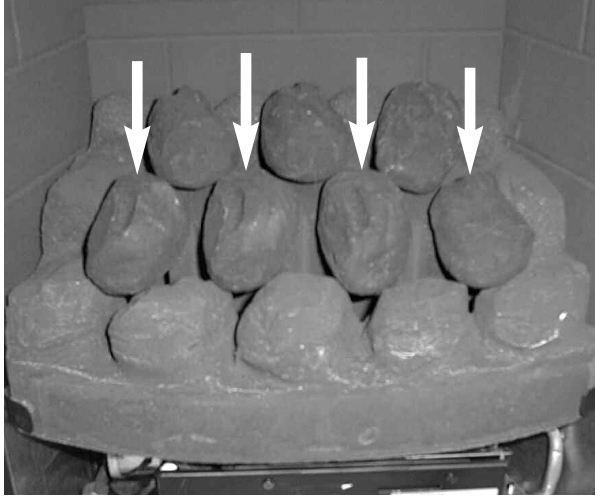

The exact position and fit of the coals may be finely adjusted to give the best appearance.

**Warning :** Use only the coal set supplied with the fire. When replacing the coals remove the old coals and discard them. Fit a complete set of coals of the correct type. Do not fit additional coals or any coals other than a genuine replacement set.

#### 5.4 ASSEMBLING THE FUEL-BED - Pebble Fuelbed Model

- a) Place the fuelbed base centrally on to the fuelbed support and push fully backwards to the rear face of the fibre boards **Make sure that the fuelbed base is located centrally in the fire box.** See Fig. 29 below

Fig. 29



- b) Position the front row of four large loose pebbles along behind the first row of pebbles, ensuring that the flame paths as indicated are not interrupted. See Fig. 30 below

Fig. 30

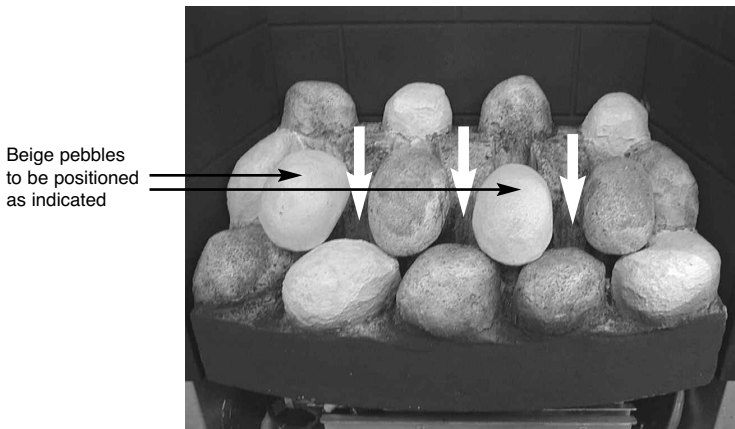

- c) Fit the three small pebbles onto the ribs in the fuelbed as shown below, ensuring that the rear flame paths as indicated are not interrupted. See Fig. 31 below.

**Fig. 31**

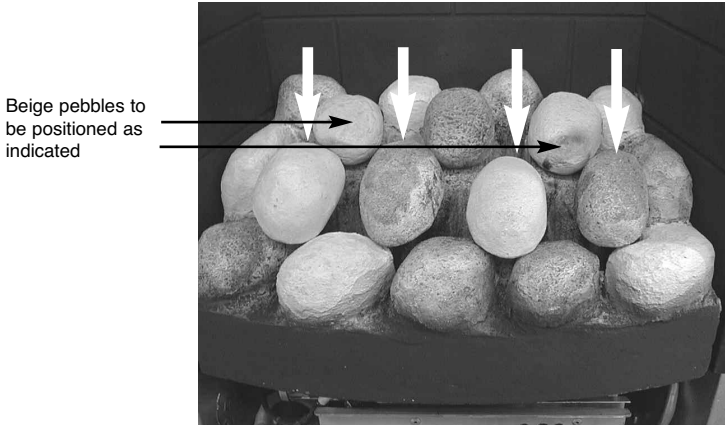

**The exact position and fit of the pebbles may be finely adjusted to give the best appearance.**

**Warning : Use only the pebble set supplied with the fire. When replacing the pebbles remove the old pebbles and discard them. Fit a complete set of pebbles of the correct type. Do not fit additional pebbles or any pebbles other than a genuine replacement set.**

## 5.5 ASSEMBLING THE FUEL-BED - Driftwood Fuelbed Model

- a) Place the fuelbed base centrally on to the fuelbed support and push fully backwards to the rear face of the fibre boards **Make sure that the fuelbed base is located centrally in the fire box.** See Fig. 32 below

**Fig. 32**



- b) Position the piece of driftwood with the letter “A” stamped onto the bottom face of it in the position at the left-hand side of the fuelbed matrix. Ensure the positioning grooves as shown are on the top face of the piece of driftwood. See Fig. 33 below.

**Fig. 33**

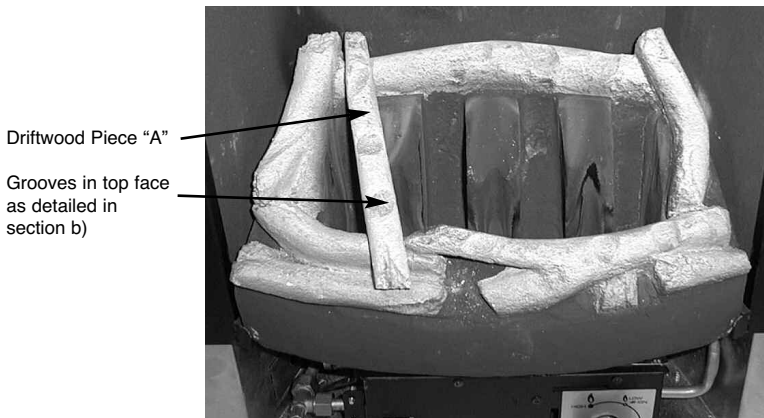



- c) Position the piece of driftwood with the letter “B” stamped onto the bottom face of it in the position at the centre of the fuelbed matrix. Ensure the positioning grooves as shown are on the top face of the piece of driftwood. See Fig. 34 below.

**Fig. 34**

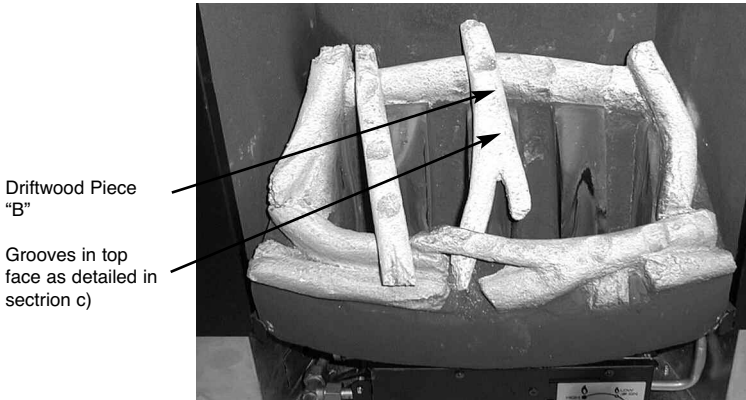

- d) Position the piece of driftwood with the letter “C” stamped onto the bottom face of it in the position at the right-hand side of the fuelbed matrix. Ensure the positioning grooves as shown are on the top face of the piece of driftwood. See Fig. 35 below.

**Fig. 35**

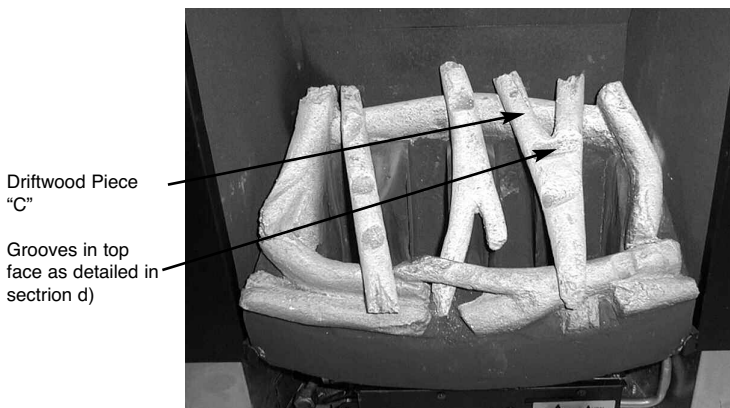

- e) Position the piece of driftwood with the letter “D” stamped onto the bottom face of it in the position at the right-hand side of the fuelbed matrix. Ensure this piece of driftwood is located into the groove in the front right hand side of the fuelbed matrix . See Fig. 36 below.

**Fig. 36**

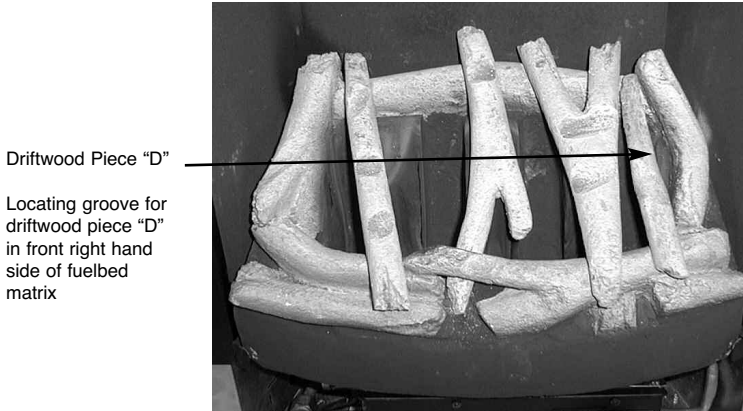

- f) Position the piece of driftwood with the letter “E” stamped onto the bottom face of it in the position at the front centre of the fuelbed matrix. Ensure this piece of driftwood is located into the groove on driftwood piece “C” . See Fig. 37 below.

**Fig. 37**

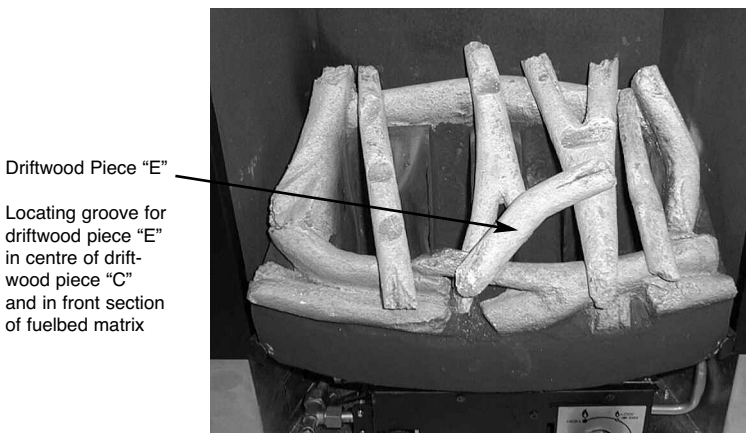

- g) Position the piece of driftwood with the letter “F” stamped onto the bottom face of it in the across the centre of the driftwood pieces “A”, “B” & “C”. Ensure this piece of driftwood is located into the groove’s on the top face of driftwood pieces A, B & C . See Fig. 38 below.

**Fig. 38**

Driftwood Piece “F”  
Locating grooves for driftwood piece “F” in centre of driftwood piece “A”, “B” & “C”



- h) Position the piece of driftwood with the letter “G” stamped onto the bottom face of it in the across the left hand side of the fuelbed matrix, locating into the grooves on driftwood pieces “A” & “B”. See Fig. 39 below.

**Fig. 39**

Driftwood Piece “G”  
Locating grooves for driftwood piece “G” in top of driftwood piece “A” & “B”



**Warning : Use only the driftwood set supplied with the fire. When replacing the driftwood remove the old driftwood pieces and discard them. Fit a complete set of driftwood pieces of the correct type. Do not fit additional driftwood or any driftwood pieces other than a genuine replacement set.**

**THE FOLLOWING STATEMENT IS APPLICABLE TO ALL FUEL-BED TYPES**

**This appliance uses fuel effect pieces containing Refractory Ceramic Fibres (R.C.F.), which are man-made vitreous silicate fibres. Excessive exposure to these materials may cause temporary irritation to eyes, skin and respiratory tract. Consequently, it makes sense to take care when handling these articles to ensure that the release of dust is kept to a minimum. To ensure that the release of fibres from these R.C.F. articles is kept to a minimum, during installation & servicing we recommend that you use a HEPA filtered vacuum to remove any dust and soot accumulated in and around the fire, before and after working on the fire. When replacing these articles we recommend that the replaced items are not broken up, but are sealed within a heavy duty polythene bag, clearly labelled as “RCF waste”. This is not classified as “hazardous waste” and may be disposed of at a tipping site licensed for the disposal of industrial waste. Protective clothing is not required when handling these articles, but we do recommend you follow the normal hygiene rules of not smoking, eating or drinking in the work area, and always wash your hands before eating or drinking.**

**This appliance does not contain any component manufactured from asbestos or asbestos related products.**

**IMPORTANT INFORMATION REGARDING FUELBED POSITION ON BOTH COAL, PEBBLE & DRIFTWOOD MODELS.**

- d) Before continuing with the installation, ensure that the fuelbed is located behind the locating tabs as shown below in Fig. 40, not on top of the locating tabs as shown in Fig. 41

Fig. 40 - Shows correct location of fuelbed

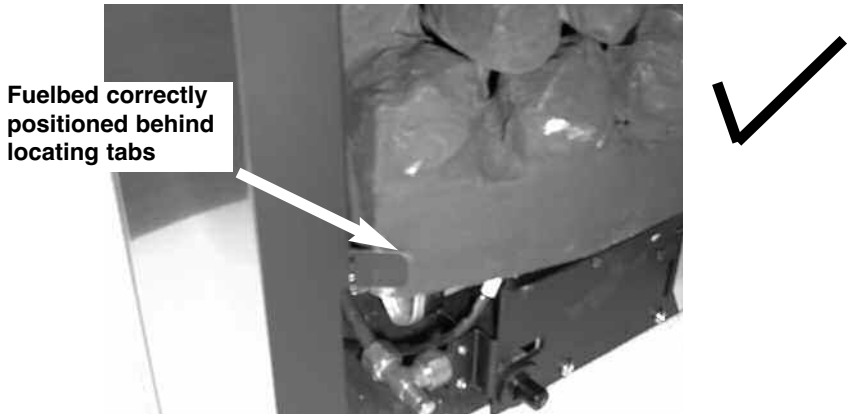
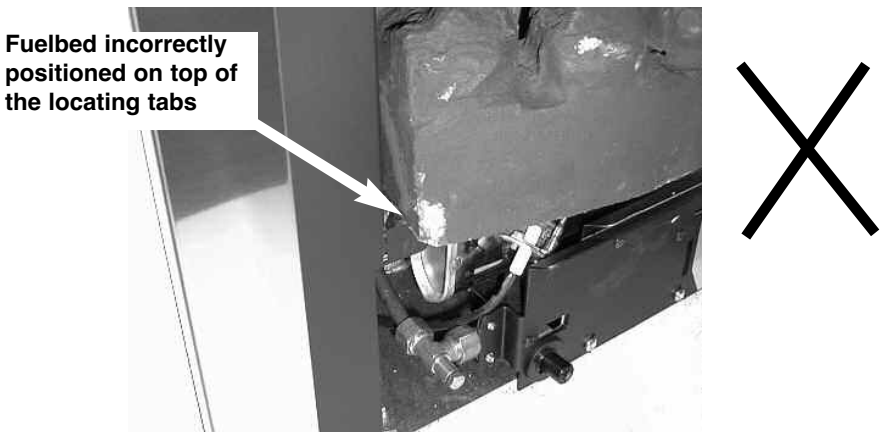

Fig. 41 - Shows incorrect location of fuelbed



## 5.6 Cleaning - WARNING

Before attempting any cleaning operation ensure that the fire has been allowed to fully cool. The Brass fret that was supplied with the fire (dependent upon model chosen) is real brass and therefore will discolour with use and should be cleaned with a proprietary metal polish. The chrome & brass effect trims and chrome effect fret that was supplied with the fire (dependent upon model chosen) should only be cleaned with a clean, damp cloth.

The trim is best cleaned in position on the fire when the appliance is not running and is cool. Black painted metal parts should be gently cleaned with a damp cloth.

### Cleaning the Fuelbed

We do not recommend cleaning of the coals or fuelbed components as these are fragile and damage may result. **None of these parts must be washed or exposed to any cleaning agents or water.** Any damaged parts must be replaced by contacting your dealer or telephoning BFM Europe Ltd. on the number stated on the rear cover of this book. The coals or pebbles must only be replaced with a complete and genuine replacement set and the fire must never be run with the wrong number or damaged coals / pebbles. The fuel-bed must be carefully re-assembled as stated in section 5.3, 5.4 & 5.5 (dependent upon model chosen), pages 36-45.

### Removal / Re-Fitting the Trim

Refer to pages 27 & 28 for details on removal and re-fitting the trims

### PEBBLE & DRIFTWOOD MODELS

- a) Fit the outer trim assembly to the firebox with the magnets provided. NB. The fret is a loose item and located beneath the trim assembly.

### Removal / Re-fitting of the Fret & Ashpan Cover

- a) Remove the fret & ashpan cover from the packaging.
- b) Place fret up to the front radiused section of the fuelbed, taking care not to move coal positions.
- c) Place ashpan cover under fret assembly and centralise.

**NOTE :** Some models in this range are not supplied with a fret from the factory, therefore please consult your local retailer for fitting advice on the type of fret supplied with these models.



## USER REPLACEABLE PARTS

The only user replaceable parts on this fire are the fuelbed components and coals or pebbles which may be replaced as described in the above section. Replacement of any other parts must be carried out by a competent person such as a CORGI registered gas installer. The part numbers of the user replaceable parts are as follows, these are available from BFM Europe Ltd. who may be contacted at the number on the rear cover of this book.

Coal Pack	B-67050	Coal Fuelbed Matrix	B-67040
Pebble Pack	B-68240	Pebble Fuelbed Matrix	B-68230
Driftwood Fuelbed Matrix	B-81160	Driftwood Pack	B-81170

**Due to our policy of continual improvement and development the exact accuracy of descriptions and illustrations cannot be guaranteed.**

Part no. B-67170  
Issue 10



BFM Europe Ltd.  
Trentham Lakes  
Stoke-on-Trent  
Staffordshire  
ST4 4TJ

[www.bfm-europe.com](http://www.bfm-europe.com)

**Telephone - General Enquiries :**  
**Telephone - Service :**

**(01782) 339000**  
**(0844) 7700169**