

## Installation instructions

MAKE SURE MAINS INPUT HAS A 3 AMP FUSE FITTED.

Installation should be carried out by a qualified electrician or heating engineer.

Position the wallplate with 70 mm clearance to its right, 25 mm above and 150 mm below. Ensure that the supporting surface will fully cover the back of the timeswitch.

Fix the wallplate, terminals at the top, either direct to a flat wall using wall plugs and 1" x No.6 woodscrews or on a flush mounting single conduit box type UA1 (BS4662) using M3.5 x 14 mm screws. DO NOT use a surface mounting box.

Make wiring connections as shown in the wiring diagram.

Tempus 2 has volt-free switching so a link from L to 1 is required for 230V output. For surface wiring, snap out the cable entry strip on the bottom edge of the wallplate. Tempus 2 is double insulated and needs no earth connection but an earth continuity terminal is provided if required.

Select 5/2 day or 7 day mode referring to the jumper position diagram.

There are two positions marked C/D. The jumper should be removed if necessary and placed across the pins which correspond to the desired option. A/B are not used.

Fit the Tempus 2 onto the wallplate and tighten the securing screws. Check that the fuse is rated correctly (3A) and switch on the mains supply.

## Factory pre-set programme

	Mon-Fri	Sat & Sun
1st ON	6.30am	7.00am
1st OFF	8.30am	9.00am
2nd ON	12.00 noon	12.00 noon
2nd OFF	12.00 noon	12.00 noon
3rd ON	4.30pm	4.00pm
3rd OFF	10.30pm	11.00pm

## Never fit the programmer to a live wallplate

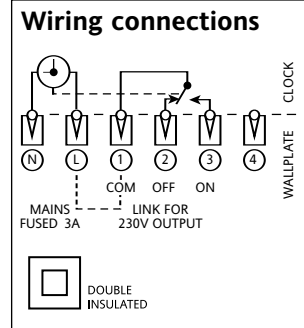

## Jumper position

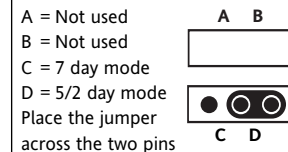

## Technical data

Voltage	230V AC +15% -10% 50 Hz
Rating	2 (1) A 230V AC
Wiring	Designed for Fixed Wiring only to comply with current I.E.E. regulations
Battery Backup	Display: Typically 1 hour Timekeeping: 7 to 8 hours Programme: Minimum 1½ years
Programme Resolution	10 minutes
Ambient Temperature	Operating: 0°C to 50°C Storage: -20°C to 50°C
Maintenance	No user maintenance should be attempted.

## Invensys Controls Europe

Customer Service Tel: 0845 130 5522  
Customer Service Facsimile: 0845 130 0622  
Technical Helpline Tel: 0845 130 7722  
Website: www.draytoncontrols.co.uk  
Email: customer.care@invensyscontrols.com

Conforms to the essential requirements of the following directives:  
89/336/EEC – Electromagnetic compatibility  
73/23/EEC – Low voltage directive



Invensys continuously seek to improve products and reserve the right to make changes without notice

090-686 Issue C

# Drayton

## Tempus 2 electronic timeswitch User instructions



The Tempus 2 electronic timeswitch will automatically switch ON and OFF up to three times a day. You can select one set of times for weekdays and different times for weekends (5/2 day), or programme different times for each day of the week (7 day).

The BOOST feature gives an extra one or two hours ON time when selected. The display will show the next switching time as well as the actual time of day. In the event of a power failure, the battery back-up will hold the programme times in memory.

All changes to clock and programme times are made

using the slider switch, together with the TIME and DAY buttons. Follow the step-by-step instructions overleaf to set your desired programme.

**Important note: If you are replacing an old style Tempus, move the wire connected to terminal 2 on the wall-plate to terminal 3 (ON).**

**Please read the following notes before programming your Tempus**

You cannot set the first ON before midnight (i.e. the previous day).

If you try to set an ON time after it's matching OFF time,

both will 'lock' and the ON and OFF symbols in the display will flash alternately.

To omit one day from your programme whilst in 7 day mode, set each pair of ON and OFF times together. Times must be different for each pair to avoid disrupting the logic of the Tempus.

Press SELECT and TIME + at the same time to return all settings to factory pre-sets.

The slider switch must be in the RUN position before the cover will close.

**To select 5/2 day or 7 day modes see installation instructions on back page.**

## Setting the clock

Move slider switch to the  position.

Press DAY button to move  symbol to today's day.

Press TIME button to set time. (*Morning times do not have AM symbol*).

Return slider switch to RUN position if you want to use the pre-set programme times or see below to make changes.

**During installation, your Tempus 2 will have been set for either 5/2day or 7 day programming. Refer to the appropriate section below.**

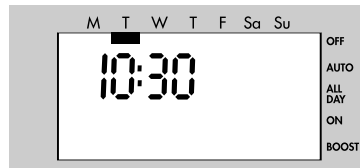

## Setting the programme in 5/2 day mode

Move the slider switch to the first ON position. The display will now show the first ON time and the  symbol will be below the days M-F.

If the setting is suitable, do nothing more. Press the TIME button if you wish to alter settings.

Move the slider switch to all the ON and OFF markers, making changes as required.

Move slider switch back to the first ON.

Press the DAY button once to move the  symbol to Sa and Su.

The display will now show the first ON for the weekend.

Change times as required and do the same with all ON's and OFF's. Return slider switch to the RUN position.

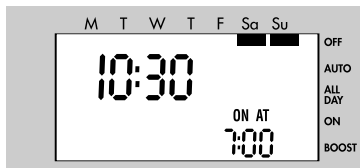
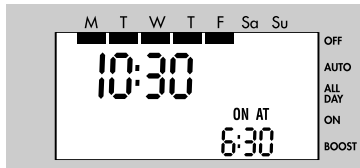

## Setting the programme in 7 day mode

Move the slider switch to the first ON position. To programme in 5/2 day mode, follow instructions above. If you wish to set each day at different times press the DAY button twice. The display will now show the first ON time and the  symbol will be below the M. If the setting is suitable, do nothing more. Press the TIME button if you wish to alter settings.

Move the slider switch to all the ON and OFF markers making changes as required.

Press DAY button to move  to all other days and change programme to suit.

Return slider switch to RUN position.

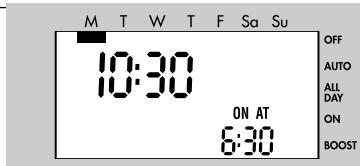

## Operating mode

Press SELECT button to choose either:

OFF = Continuously OFF

AUTO = Switching ON and OFF as programmed

ALL DAY = On once from first ON to last OFF

ON = Continuously ON

The  symbol on the display will indicate which mode you have selected. ON, OFF and the next switching times are also shown.

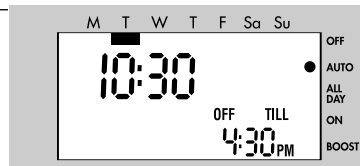

**Your Tempus is now programmed to your requirements and ready to operate. The following features are used to make temporary changes without affecting the programme.**

## Advance

Press the ADVANCE button to temporarily override the programmed times, or go forward to the next period. If your Tempus is OFF, it will switch ON, and vice versa. Note that the displayed switching time will change. Pressing ADVANCE again will cancel the override and return to the original programme. ADVANCE will only operate in AUTO or ALL DAY modes.

## Boost

Press the BOOST button once for one extra hour ON, or twice for two hours.

The  symbol will appear in the display with a new next switching time.

Press again to cancel BOOST and return to programme.

Pressing ADVANCE will also cancel BOOST.

Pressing BOOST during an ON period will extend the ON time by one or two hours.

Whilst the programme is OFF, pressing BOOST within one hour of the next ON will move the programme into that period.



## Holiday

Move the slider switch to the position marked . Press TIME button to set number of days (midnight to midnight) the system is required OFF.

Return the slider switch to RUN position.

The system will now shut down for the number of days set. Pressing any key will cancel holiday settings.

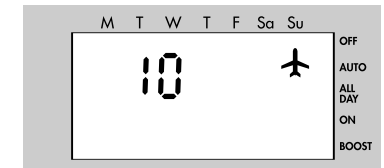

## BST/GMT time changes

Use this feature to change the clock by one hour in the spring and autumn.

Do not move the slider switch. Simply press TIME + once to go forward one hour, or TIME - to go back.