



FP975

7-Day Electronic Programmer

**For a large print version of these instructions
please call Marketing on 0845 121 7400.**



Certification Mark

This product complies with the following EC Directives:
Electro-Magnetic Compatibility Directive.
(EMC) (2004/108/EC)
Low Voltage Directive.
(LVD) (2006/95/EC)



Danfoss can accept no responsibility for possible errors in catalogues, brochures, and other printed material. All trademarks in this material are property of the respective companies. Danfoss and the Danfoss logotype are trademarks of Danfoss A/S. All rights reserved.

Installation Instructions

FP975

7 Day Electronic Programmer

GB

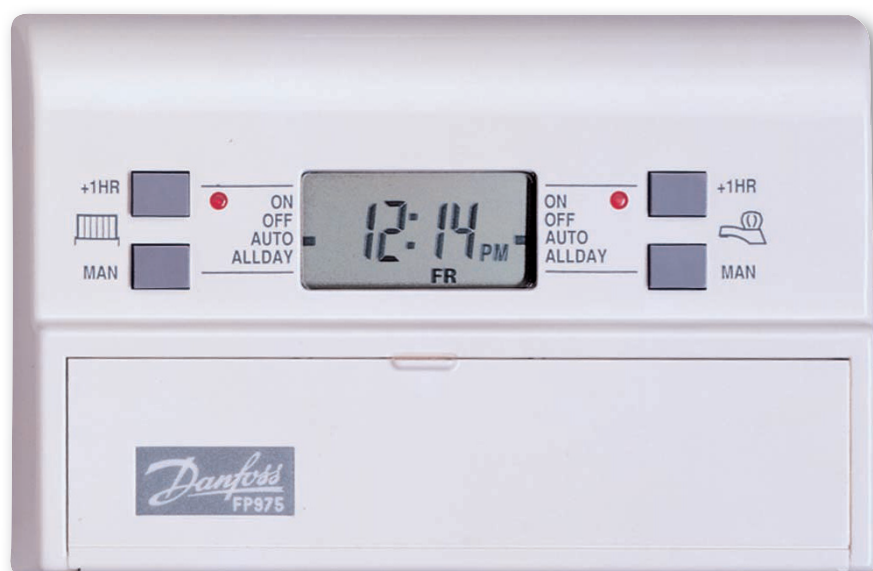

Index

1.0 Installation Guide	4
2.0 System Overview	4
3.0 Installation	4
3.1 DIL Switch Settings	4
3.2 New Installations.....	5
3.3 Existing Installations.....	8
3.4 Wiring.....	9
3.5 230 Vac Fully Pumped System - Zone Valves	9
3.6 230 Vac Controlled Gravity Hot Water	10
3.7 230 Vac Fully Pumped System - Mid-Position Valves	10
3.8 Wiring Conversions	11

1.0 Installation Guide

Please Note:

This product should only be installed by a qualified electrician or competent heating installer and should be in accordance with the current edition of the IEEE wiring regulations.

GB

2.0 System Overview

Specification	
Power supply	230 Vac \pm 15%, 50/60 Hz
Switching action	2 x SPDT voltage free, Type 1BS
Switch rating	10-230 Vac, 3(1)A
Battery back-up	24 hours minimum
Timing Accuracy	\pm 1 min/month
Setting/Running Accuracy	\pm 1 minute
Max. Ambient Temperature	45°C
Dimensions, mm (W, H, D)	148 x 96 x 42
Design standard	EN 60730-2-7
Control Pollution Situation	Degree 2
Rated Impulse Voltage	2.5kV
Ball Pressure Test	75°C

3.0 Installation

3.1 DIL Switch Settings

Before mounting the unit, ensure the 4 DIL switches on the rear of the unit have been moved to the required settings.

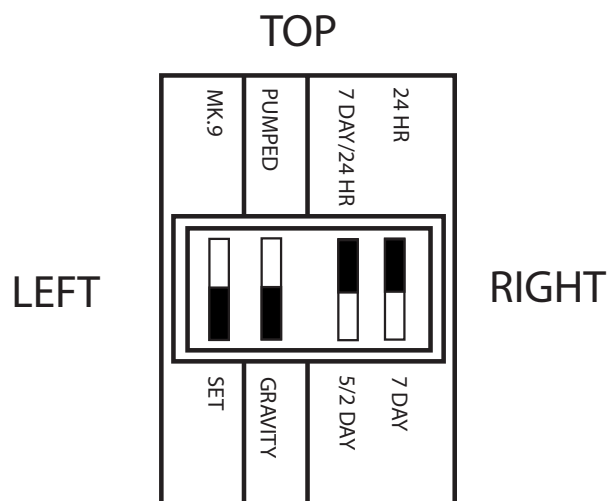

MK.9 or SET

The FP975 is supplied fitted with a Danfoss Randall SET wallplate. However the FP975 will also mount directly onto a Danfoss Randall MK.9 wallplate without the need for wiring changes. However when used with existing MK.9 wallplates the left hand switch must be set in the MK.9 position to re-configure the time control to match MK.9 wiring connections.

PUMPED or GRAVITY

When this switch is in the **PUMPED** position the Heating and Water outputs are **UNLINKED**. When in the **GRAVITY** position the Water output is **LINKED** to the Heating output so that whenever the Heating is **ON** the Water will also be **ON** regardless of the Water programme.

Place the switch in the **PUMPED** position if the system being controlled is a) fully pumped with a mid-position valve, b) fully pumped with a two port zone valve in each circuit, c) **GRAVITY** Hot Water, **PUMPED** Heating with a two port zone valve with SPDT auxiliary switch in the gravity primary circuit (and wired in accordance with diagrams on pages 9-10).

Place the switch in the **GRAVITY** position if the system being controlled is a) fully pumped, but with only a single two port zone valve in the Heating circuit, b) **GRAVITY** Hot Water, **PUMPED** Heating with no zone valves.

7 Day, 5/2 Day or 24 Hour

When both switches are in the **7 DAY** position each day of the week may be programmed with different **ON/OFF** times. When the switch is in the **5 DAY/2 DAY** position, weekdays (Mon-Fri) can be programmed with one set of **ON/OFF** times, and weekends (Sat-Sun) can be programmed with a different set. When both switches are in the **24 hour** position the same set of times will be repeated in every 24 hour period.

3.2 New Installation

1. Fix the wallplate to the wall or plaster box as required.
When fixing the wallplate note that the terminals are at the top, and the vertical centre line of the unit lies between terminals N and L.
2. Surface cables can only enter from below the unit. If mounted on a plaster box, cables can enter from the rear through the aperture in the wallplate.

GB

Direct Plug-In Upgrade for Existing Programmers

3. The FP975 offers direct plug-in replacement to the following models (see below):

Manufacturer	Model	Fully Pumped Systems Pumped/ Gravity Selector Position	Gravity H.W. Systems Pumped/ Gravity Selector Position	Wallplate Type	Mode Sw Position
Danfoss Randall	FP975	Pumped	Gravity	SET	SET
	922	Unlinked	Linked	MK.9	MK.9
	972	Unlinked	Linked	MK.9	MK.9
	SET 2*	Unlinked	Linked	SET	SET
	SET 5	Unlinked	Linked	SET	SET
	Diadem 425	Pumped	Gravity	SET	SET
Horstmann	Tiara 425	Pumped	Gravity	SET	SET
	Tiara 525	Pumped	Gravity	SET	SET
	Tiara 527	Pumped	Gravity	SET	SET



IMPORTANT NOTE

If the timeswitch to be replaced is listed below it may be worth considering a FP715 Si as an alternative to the FP975. The FP715 Si offers wallplate compatibility for those models listed below, although some re-wiring may be required.

MAKE	MODELS
ACL	LS2411, LS522, LS722, LP241, LP522, LP722
Drayton	Tempus 3, Tempus 4, Tempus 7
Landis & Gyr	RWB 2, RWB 2-9, RWB 200, RWB 252, RWB 20, RWB 40
Glowworm	Mastermind
Potterton	Mini-Minder

GB

If the new unit is replacing an existing time control having an incompatible wiring configuration, then the wiring conversions (tables A and B, pages 12-15) will be of assistance.

4. For wiring connections please refer to diagrams on pages 9-10. Please note, the FP975 does not require an earth connection, although a terminal is provided for earth continuity purposes.
5. Ensure that the two retaining screws on the top of the timeswitch are fully unscrewed. Locate the retaining lugs on the bottom inside surface of the plug-in module under the wallplate base and hinge the unit upwards until the module is pressed fully against the top of the wallplate. Tighten the two screws on the top of the module to secure the module to the wallplate.
6. A small blanking plug is supplied to blank the unused recessed bottom fixing screw.
7. Before setting the programmes the unit should be **RESET** by pressing the recessed button marked **R/S**. Ensure the mains power to the control circuit is switched on, and check the circuits as follows.
8. Use the  (Hot Water) **SELECT** button to get to the **ON** mode to switch the hot water output **ON**. Adjust the cylinder thermostat and check the service operates correctly. Use the **SELECT** button to get to **OFF** mode and check that the service does not operate.
9. Use the  (Heating) **SELECT** button to get to the **ON** mode to switch the heating output **ON**. Adjust any remote thermostat(s) and check that the service operates correctly. Use the **SELECT** button to get to **OFF** mode and check that the service does not operate.

3.3 Existing Installation

Ensure that the power to the existing unit is switched off prior to removal.

SYSTEMS RE-USING EXISTING WALLPLATE

Use the table on page 6 to confirm wallplate compatibility.

GB

- If the existing wallplate is of the SET pattern, follow instruction 5-9 from the “New Installations” section.
- Should the existing product be a Danfoss Randall MK.9 time control the instructions below should be followed:
 1. Remove and discard the white test point cover fitted to the top of the MK.9 wallplate.
 2. Slide the small switches on the rear of the module marked MK.9 - SET to the MK.9 position.
 3. Ensure that the two retaining screws on the top of the timeswitch are fully unscrewed. Firmly press the module onto the wallplate and tighten the two screws on the top of the module. An additional fixing screw to hold the bottom of the unit onto the wallplate is packed separately and must be fitted. The screw should be placed into the recessed hole, beneath the programming flap, adjacent to the **COPY** button, screwed through the plastic retaining ring and securely tightened.
 4. Follow steps 5-9 from the “New Installations” section.

SYSTEMS HAVING INCOMPATIBLE BACKPLATES

Follow the “New Installations” instructions paying particular attention to item 3).

3.4 Wiring

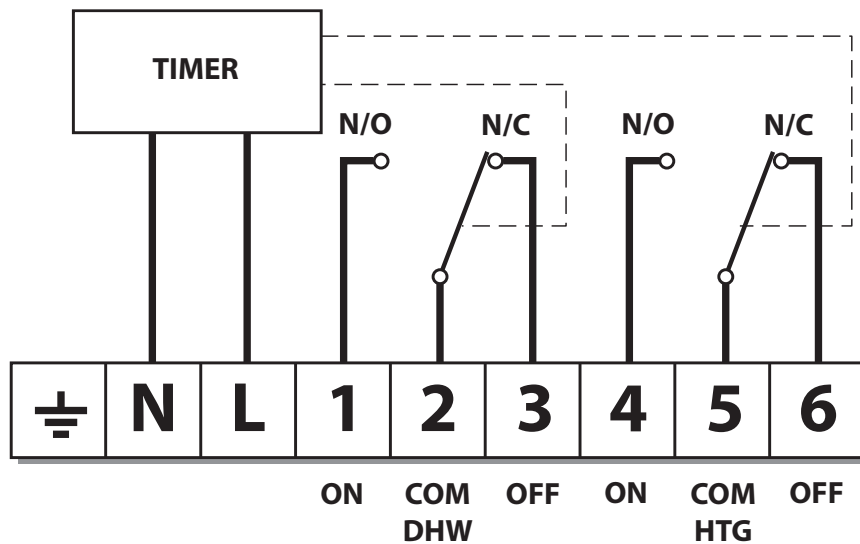

GB

For 230 Vac systems link L, 2 & 5.

For Wiring Conversion tables see pages 12-15.

Always switch off mains first and never fit programmer to a live wallplate.

3.5 230 Vac Fully Pumped System

2 x 2-port Zone Valves with Aux. Sw. PUMPED switch selection

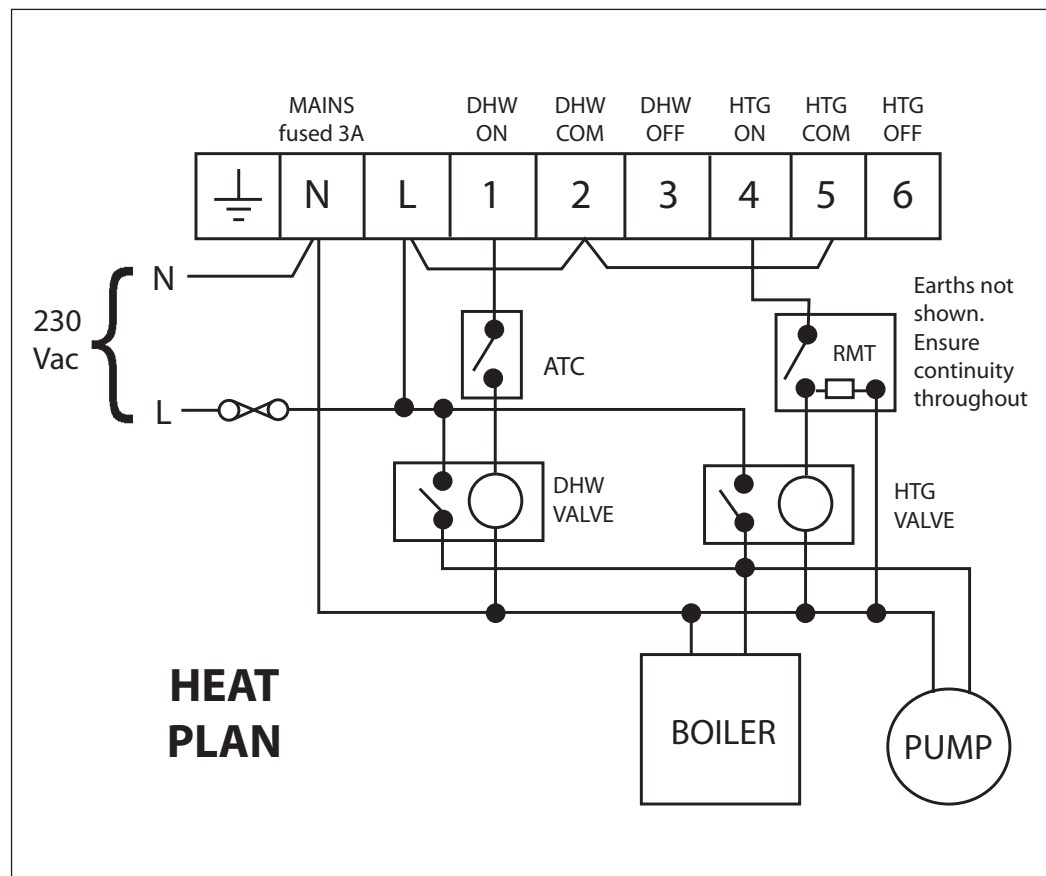

3.6 230 Vac Controlled Gravity Hot Water Pumped Heating System *PUMPED Switch Selection*

GB

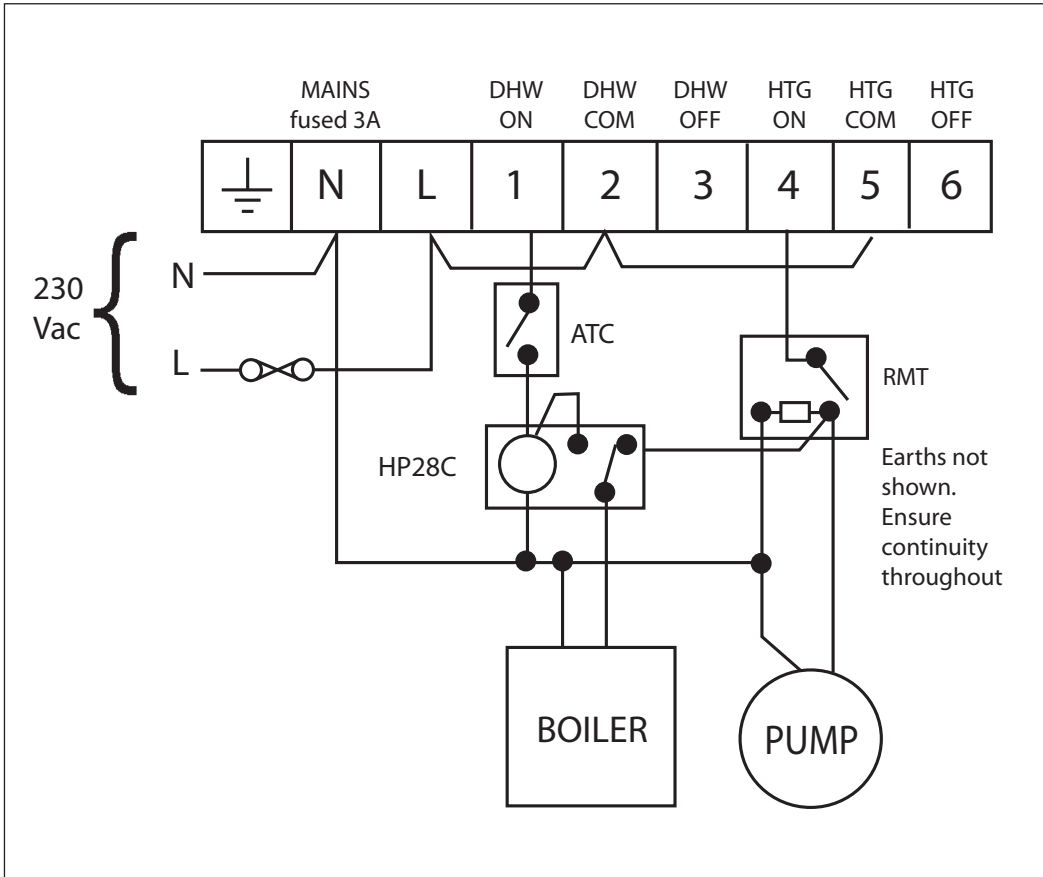

3.7 230 Vac Fully Pumped System *3-Port Mid-Position Valve PUMPED Switch Selection*

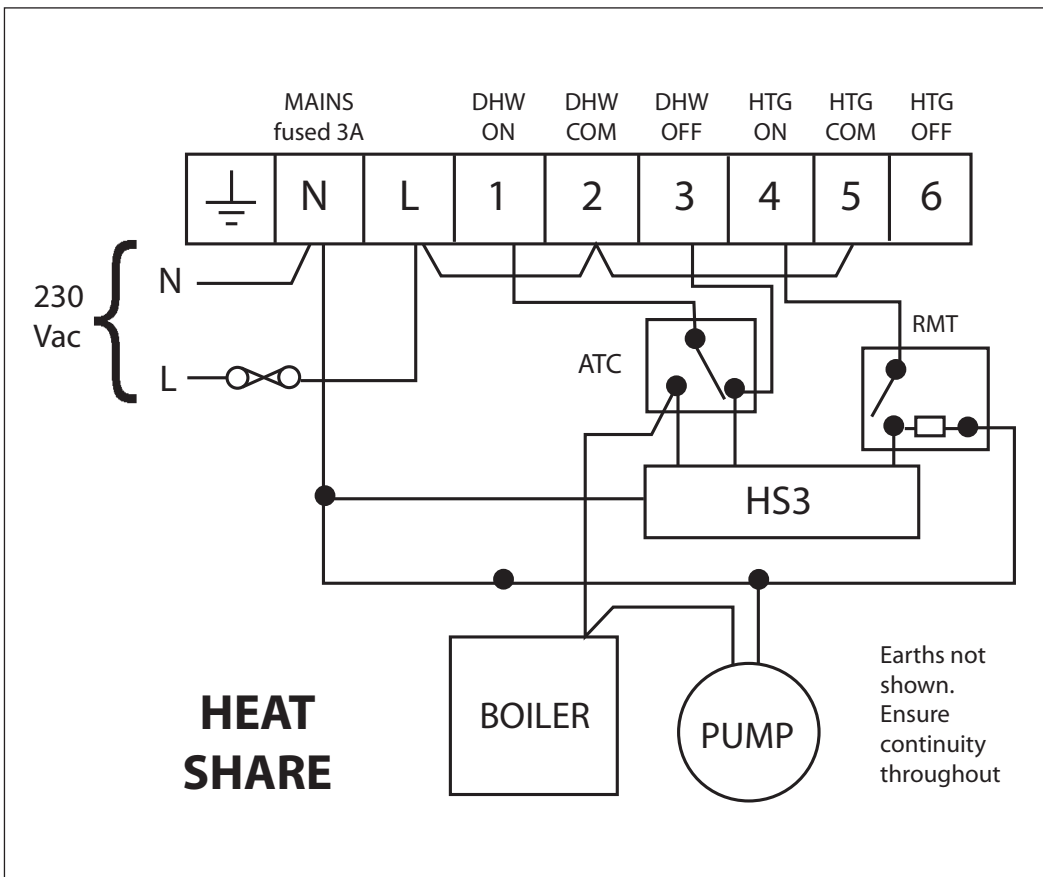

3.8 Wiring Conversions

See pages 12-15

WIRING CONVERSIONS to be used when replacing the following programmers with the FP975. Some time controls are connected differently depending on the type of system they are controlling. Consult the column headed "NOTE This conversion .." to determine whether Table A (pages 12-13) or Table B (pages 14-15) should be used. If in any doubt, contact our Technical Services Department before proceeding with the replacement.

















GB

Table A DANFOSS RANDALL FP975 (SET MODE) Fully Pumped Systems - ensure Pumped/Gravity switch is in 'Pumped' position	MAINS			WATER			HEATING			NOTE This conversion applies only if....	An additional terminal block may be required where these disconnected leads (or pairs) should be terminated			
	⏚	N	L	ON	COM	OFF	ON	COM	OFF		A	B	C	D
		7	6	4	1	2	3	4	5					
DANFOSS RANDALL 4033	⏚	7	6	4	1	5	2	-	3					
HORSTMANN 423, AMETHYST 7 & 10	⏚	2,3	1	5	-	4	7	-	6	8				
HORSTMANN 424 GEM	⏚	2,3	1,10	4	5	6	7	8	9					
HORSTMANN LEUCITE 423 & 424	⏚	2	1	3	5	4	6	7	8	Terminals 5,8 & 10 are LINKED				
HONEYWELL ST669	⏚	N	L	6	8	7	3	5	4	Terminals 5 & 7 are LINKED				
POTTERTON EP2000, EP3000	⏚	N	L	3	-	1	4	5	2	Programme selectors UNLINKED	A	B	C	D
RANDALL 3033	⏚	1,7	6	4	-	5	2	-	3					
RANDALL 702	⏚	N	L	3	6	4	1	5	2					
SANGAMO FORM 1 410 & 414	⏚	4,5	6	1	3	2	8	-	7					
SANGAMO S409/1	⏚	N,1,3	L	2	-	-	5	-	-	6,4				
SANGAMO S409/3	⏚	3,6	7	5	-	4	1	-	2					

Table A continued DANFOSS RANDALL FP975 (SET MODE)	MAINS			WATER			HEATING			NOTE This conversion applies only if....	An additional terminal block may be required where these discon- nected leads (or pairs) should be terminated			
	⏚	N	L	ON	COM	OFF	ON	COM	OFF		A	B	C	D
SATCHWELL LIBRA & DHP 2201	⏚	N	L	1	2	3	4	5	6	LINK L - 2 - 5				
SATCHWELL ET 1401 & 1451	⏚	1	2	6	7	8	3	4	5					
SMITHS IND. CENTROLLER 90	⏚	1	2	7	6	8	4	3	5					
SMITHS IND. CENTROLLER 1000	⏚	1	2	5	-	-	4	-	-		3	6		
SWITCHMASTER 800 & 805	⏚	N	L	3	-	1	4	-	2	Programme selectors UNLINKED				
SWITCHMASTER 900 & 9000	⏚	N	L	3	-	4	1	-	2					
VENNER CHC/W2 (WITH STAT)	⏚	N	L	3	-	4	1	-	2	Programme selectors UNLINKED	A	B	C	
VENNER CHC/W2 (AIR STAT LINKED)	⏚	N,2,4	L	1	-	-	A/S	-	-	Used in a system having independent control of water and heating	A/S3			
VENNER VENOTROL 80M & 80PM (WITH AIR STAT)	⏚	N,2,4	L	1	-	-	3	-	-					
VENNER VENOTROL 80M & 80PM (WITH AIR STAT)	⏚	N,3	L	2	-	1	A/S	-	4		A/S5			
VENNER VENOTROL 80M & 80PM (AIR STAT LINKED)	⏚	N,3	L	2	-	1	5	-	4					



Table B DANFOSS RANDALL FP975 (SET MODE) Gravity DHW, Pumped Heating Systems - ensure Pumped/Gravity switch is in 'Gravity' position	MAINS			WATER			HEATING			NOTE This conversion applies only if....	An additional terminal block may be required where these discon- nected leads (or pairs) should be terminated			
	⏚	N	L	ON	COM	OFF	ON	COM	OFF		A	B	C	D
DANFOSS RANDALL 102/102E/102E5/102E7	⏚	N	L	1	2	3	4	5	6	LINK L - 2 - 5				
HORSTMANN 423 DIAMOND POTTERTON 423	⏚	5	3,6	1	-	-	2	-	-					
HORSTMANN 424 DIAMOND	⏚	N	L,1,3	2	-	-	4	-	-		5	6		
HORSTMANN CORAL 423 & 424	⏚	2,3	1	BOILER (8)	-	-	AIR STAT (8)	-	-		4,7	5	6	
POTTERTON EP2000, EP3000	⏚	N	L	3	-	1	4	5	2	Programme selectors LINKED	A	B	C	D
DANFOSS RANDALL 3060 & 3020P	⏚	1,7	6	4	-	-	2	-	-		3	5		
RANDALL 701	⏚	N	L	3	6	4	1	5	2					
SANGAMO M5 410 FORM 4	⏚	4,5	3	1,6	-	2	8	-	7					
SANGAMO S409 FORMS 1 & 4	⏚	N,1,3	L	2	-	-	5	-	-		6,4			
SANGAMO (EARLY MODEL) S410 FORM 4	⏚	N,2	L	1,3	-	-	4	-	-	1 & 3 are LINKED				
SATCHWELL LIBRA	⏚	1	2	6	7	8	3	4	5					

SMITHS IND. CENTROLLER 100		N	L	3	-	-	2	-	-	-	1	4	
SMITHS IND. CENTROLLER 60		1	2	5	-	-	4	-	-	-	3		
SMITHS IND. CENTROLLER 10		N	L	3	-	-	2	-	-	-	1,4		
SMITHS IND. CENTROLLER 70		1	2	5	-	-	4	-	-	-	3	6	
SMITHS IND. CENTROLLER 1000		N	L	3	-	1	4	-	2	Programme selectors LINKED			
SWITCHMASTER 320 & 350		N	4,L	3	-	-	1	-	-		2		
SWITCHMASTER 400		N	L	3	-	-	1	-	4		2		
SWITCHMASTER 600		N	L	3	-	-	1	-	-		2	4	
SWITCHMASTER 900 & 9000		N	L	3	-	4	1	-	2	Programme selectors LINKED	A	B	C
VENNER VENOTROL		N,A,M	L, L1	V	-	-	S,F	-	-		T,P	O	
VENNER VENOTROL 80 (AIR STAT)		N,1,3,4	L	2	-	-	A/S	-	-		A/S, 5		
VENNER VENOTROL 80 (AIR STAT LINKED)		N,1,3,4	L	2	-	-	5	-	-				
VENNER CHC/W2 (WITH STAT)		N,2,4	L	1	-	-	A/S	-	-	Used in a system having control of water only or water and heating together	A/S, 3		
VENNER CHC/W2 (AIR STAT LINKED)		N,2,4	L	1	-	-	3	-	-				
VENNER VENOTROL 80P (WITH AIR STAT)		N,1,3	L	2	-	-	A/S	-	4		A/S, 5		
VENNER VENOTROL 80P (AIR STAT LINKED)		N,1,3	L	2	-	-	5	-	4				





Danfoss Randall Ltd.

Amphill Road
Bedford MK42 9ER

Tel: 0845 1217 400

Fax: 0845 1217 515

Email: danfosrandall@danfoss.com

Website: www.danfoss-randall.co.uk