



TS715Si
*Electronic Single Channel Timeswitch
with Service Interval Timer*

**For a large print version of these instructions
please call Marketing on 0845 121 7400.**



Certification Mark

This product complies with the following EC Directives:
Electro-Magnetic Compatibility Directive.
(EMC) (2004/108/EC)
Low Voltage Directive.
(LVD) (2006/95/EC)

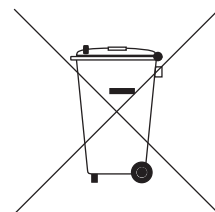

Danfoss can accept no responsibility for possible errors in catalogues, brochures, and other printed material. All trademarks in this material are property of the respective companies. Danfoss and the Danfoss logotype are trademarks of Danfoss A/S. All rights reserved.

TS715Si

Electronic Single Channel Timeswitch with Service Interval Timer

GB



Index

1.0 Installation Overview	4
2.0 Product Specification	4
3.0 Installation	
3.1 Wiring.....	5
3.2 DIL Switch Settings	6
4.0 Advanced Programming Options	6
5.0 Copy Functions Explained	7
6.0 Service Interval Timer	9
7.0 Wiring Conversions	10-13

1.0 Installation Overview

Please Note:

This product should only be installed by a qualified electrician or competent heating installer and should be in accordance with the current edition of the IEEE wiring regulations.

GB

2.0 Product Specification

Specification	230V model	24V model
Power supply	230 Vac, ±15%, 50/60 Hz	24 Vac, ±15%, 50/60 Hz
Switching action	1 x SPDT voltage free, Type 1B	
Switch rating	24-230 Vac, 3(1)A	
Battery back-up	24 hours minimum	
Setting/Running Accuracy	± 1 minute	
Dimensions, mm (W, H, D)	135 x 88 x 32	
Design standard	EN 60730-2-7	
Control Pollution Situation	Degree 2	
Rated Impulse Voltage	2.5 kV	
Ball Pressure Test	75°C	

3.0 Installation

- Remove wallplate from unit by unscrewing the two screws on the bottom edge of the unit.
- From the top left hand corner of the wallplate, there must be clearances of at least 140 mm to the right, 15mm to the left, 30mm above and 100mm below in order to mount the plug-on module.

- The wallplate must be securely mounted either directly to the wall using suitable wood screws or to a flush mounted 1-gang electrical accessory box using M3.5 screws.

- Cable access can either be from behind for concealed cabling, or from below for surface cabling. If surface cable is used, cut out cable access slot on plug-on module prior to mounting.

- For wiring connections refer to diagram below.

TS715 Si models are double insulated and do not require an earth connection, however a parking terminal is provided on the wallplate. This is clearly marked with an Earth symbol.

- Prior to mounting the plug-on module, DIL switches on the rear of the plug-on module must be set. See diagram on page 6 for available options.

- Mount plug-on module to wallplate by locating tabs on top of wallplate in apertures on rear of module, hinge down and press firmly to wallplate before tightening securing screws on bottom of wallplate.

3.1 Wiring

For wiring conversion tables please see pages 10-13).

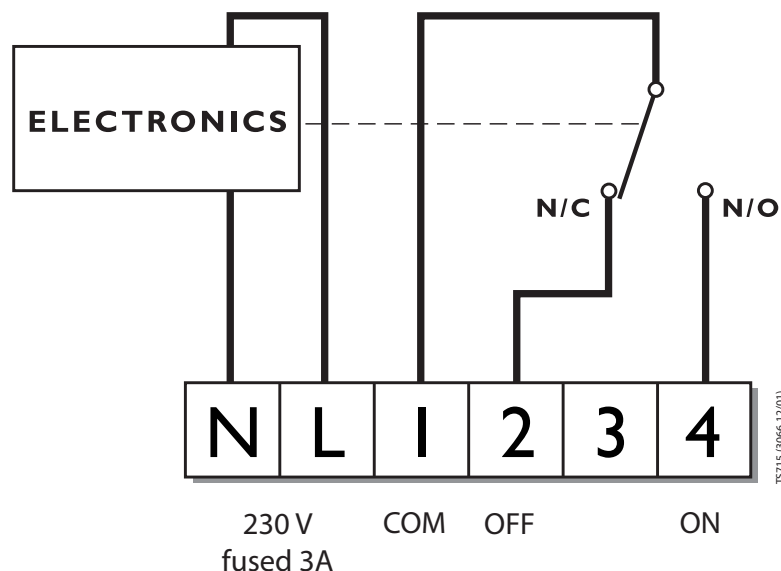

Please Note:

Link terminals L and 1 for standard mains voltage operated systems.
On 24 volt models power supply must be wired to A & B on wallplate.

Please Note:

Always switch off mains first and never fit programmer to a live wallplate.

3.2 DIL Switch Settings

Before mounting the unit, ensure the 4 DIL switches on the rear have been moved to the required settings.

GB

Sw.1	Not Used		Not Used
Sw.2	Not Used		Not Used
Sw.3	5/2 Day		7 Day or 24 Hour
Sw.4	7 Day		24 Hour

Tick the INSTALLER SETTING box on the inside flap label to notify user in which mode their unit is set (24hr, 5/2 day or 7 day).

INSTALLER SETTING	
24 Hour	
5+2 Day	
7 Day	

4.0 Advanced Programming Options

To enter advanced programming press **PROG**, **+** and **DAY/HOL** together and hold for 5 seconds.

Option 1 - (3 or 2 On/Offs per day)

Use **+** or **-** to change between 3 or 2 on/off each day.

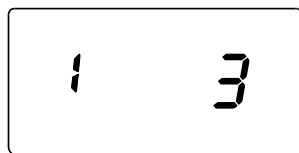

3 on/off each day (Factory setting)

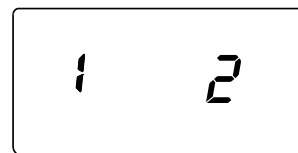

2 on/off each day

Option 2 - (Disable or enable auto time change)

Press **NEXT**, then use **+** or **-** to change between auto time change enabled to auto time change disabled.

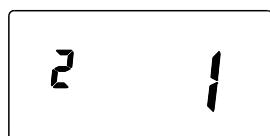

Auto time change enabled (Factory setting)



Auto time change disabled

Option 8 - (Advanced Copy Functions)

Press **NEXT**, then + or - to change between the following copy options:

- (0) Standard copy in 7 day and 5+2 day.
- (1) Enhanced copy in 7 day, standard copy in 5+2 day.
- (2) Enhanced copy in 7 day and AB copy in 5+2 day.

For an explanation of the copy features and how to use them please see below.

Press **PROG** to return to **RUN**.

5.0 Copy Functions Explained

There are 3 possible copy functions available. These are; **Standard Copy**, **Enhanced Copy**, and **AB copy**. Copy functions are enabled/disabled in the Advanced Programming Options (page 6).

Standard Copy: Pressing copy will copy the previous days events into the displayed day. The unit will then display the 1st event for the new day. This copy function is present only if the unit is set to run in **5+2 or 7 day mode**.

Enhanced Copy: The enhanced copy function is available in **7 day mode only**. This allows any day to be copied to any other day, or days. To use the enhanced copy function go into the event programming using the **PROG** button, then:

1. Use the **DAY** button to find the day to be copied from.
2. Press the **COPY** button to select the day to be copied from. When selected, the day should begin to flash.
3. Use the **DAY** button to find the day to be copied to.
4. Press **COPY** button to copy the selected day.
5. Repeat steps 3 and 4 to select and copy other days.
6. To stop copying, use the **DAY** button to go back to the flashing day and press the **COPY** button. The previously flashing day will stop flashing to indicate it has been de-selected.

NOTE: When a day has been copied to, it will remain visible and not flashing when the **DAY** button is used to select other days.

AB Copy: The AB copy function is available in **5+2 mode only** and only if activated in the Advanced Programming setting.

A and B days, when selected, can be any group of days e.g. 5+2, 4+3 etc. The days do not have to run in sequence. For example, to operate in a 5+2 day mode the days can be set as follows:

GB

A Days	B Days
Mon Tues Thurs Fri Sat	Wed Sun

To use the AB copy function – press the **PROG** button:

1. This will show the “A” days, with all the days selected.
2. Use the **DAY** button to highlight a day.
3. Subsequent presses of the **DAY** button will increment through the days.
4. Press the + button to select a specific day as an “A” day, or press the – button to specify a day as a “B” day.
5. Once the day has been selected as an “A” or “B” day the programme will automatically jump to the next day.
6. When the last day of the week is active, pressing +, -, or **DAY** will move back to the “A” days displayed with no selected (flashing) days (see image below).
7. Repeat 2 to 6 until all selections have been made.
8. When selections are completed, press the **PROG** button to move to event programming.

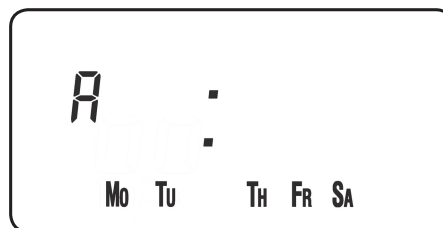

Event Programming in AB mode

1. Programme “A” day events using the + (time advance), - (time decrease), and **NEXT** (next period) buttons.
2. Press the **DAY** button to change to programme the “B” days.
3. Programme “B” day events using the + (time advance), - (time decrease), and **NEXT** (next period) buttons.

6.0 Service Interval Timer

The TS715 Si is fitted with an installer setback service interval timer. If this feature is required please contact our technical department. Setting instructions for this gas safety feature are only available to bona fide heating installers.



















GB

7.0 Wiring Conversions

(Applies only to 230 volt models)

Wiring conversions for other timeswitches which can be replaced with the Danfoss TS715-Si, refer to the second part of the table. If in any doubt, please contact our Technical Services Department before proceeding with the replacement.

GB

DANFOSS RANDALL TS715-Si	MAINS		
		N	L
		N	L
The existing wallplate may be used when replacing the following, but the wiring m link between L & COM terminals of wallplate.			
ACL LS111, LS711, LP111 & LP711		N	L
DRAYTON TEMPUS ONE & TEMPUS TWO		N	L
LANDIS & GYR RWB3		N	L
LANDIS & GYR RWB30		N	L
The TS75/TS15 wallplate must be used to replace the existing wallplate when repla mains voltage systems, fit wire link between terminal 1 & L of wallplate.			
GRASSLIN 45, 45A, 45E		2	1
HONEYWELL ST6100		N	L
HORSTMANN 423 PEARL, EMERALD & TOPAZ		N	L
HORSTMANN KMK2A YMK2		3	4
HORSTMANN 425 CORONET		N	L
DANFOSS RANDALL 911		N	L
DANFOSS RANDALL 103, 103E, 103E5 & 103E7		5	6
RANDALL 3020		1,7	6
DANFOSS RANDALL SET1		N	L
RANDALL TSR2		3	2
PEGLER SUNVIC SP20 & SP25/30		N	L
POTTERTON MYSON EP4001		N	L



















LOAD				An additional terminal block may be required where these disconnected leads (or pairs of leads) should be terminated			
COM	OFF	SPARE	ON				
1	2	3	4				

must be reconnected as shown below. In addition, in mains voltage systems, fit wire

1	2	4	3				
1	3	4	2				
-	3	1	4	2			
2	3	1	4				

using the following timeswitches. Wiring details are shown below. In addition, in

3	-		4				
1	2	3	4	-	-		
3	-	1	4	2	5	6	
1	-		2				
5	6	1	4	2	3		
5	4	2	6				
3	-	2	1				
-	-	2	4	3	5		
5	6	2	4				
1	-	4	5	6	7		
3	4	S	5				
5	2		4	A	B	C	D

DANFOSS RANDALL TS715-Si	MAINS		
		N	L
		N	L
The TS75/TS15 wallplate must be used to replace the existing wallplate when replacing mains voltage systems, fit wire link between terminal 1 & L of wallplate.			
SANGAMO M6		4,5	6
SANGAMO 410 FORM 8		4,5	3
SANGAMO S254 FORM 2, S408 FORM 5, S251 FORM 2		N	L
SANGAMO S610 FORM 2, S611 FORM 2, S612 FORM 2, S408 FORM 4, S408 FORM 6, S253 FORM 2, S255 FORM 2		N	MOTOR LIVE
SANGAMO S409 FORM 8		3,N	3,L
SANGAMO S263 FORM 2 SANGAMO S264 FORM 2		N	L
SMITHS IND. MKI, MKII		N	L
SMITHS IND. CENTROLLER 30		1	2
SMITHS IND. CENTROLLER 40		1	2
SWITCHMASTER		N	L
TOWERCHRON TC		2	1
VENNER VENNERETTE MKIIA		N	L
VENNER VENNERETTE MKIVA		2	3
VENNER VENOTIME (WITH NEON INDICATING CIRCUIT ON)		N	L
VENNER VENOTIME (WITH NEON INDICATING POWER ON)		N	L
VENNER VENNERON, VENNERON P		3	2

LOAD				An additional terminal block may be required where these disconnected leads (or pairs of leads) should be terminated			
COM	OFF	SPARE	ON				
1	2	3	4	A	B	C	D

Using the following timeswitches. Wiring details are shown below. In addition, in

3	2	7	1	8			
-	2	6	1	7	8		
-	-		LOAD				
SWITCH LIVE	-		LOAD				
6	-	1	2				
-	OFF		ON				
P2	-	P1	P3				
-	-	3	4,5	6			
-	-	3	4,5				
4	-	2	1	3			
4	-	3	7	8	9	10	11
LINE	-		LOAD				
4	-		1				
-	1	2	3				
2	1		3				
1	-		4				

GB



Danfoss Randall Ltd.

Ampthill Road
Bedford MK42 9ER

Tel: 0845 1217 400

Fax: 0845 1217 515

Email: danfosrandall@danfoss.com

Website: www.danfoss-randall.co.uk