

103E7

*7-day electronic timeswitch
for controlling hot water
and heating*

Installation & User Instructions

including Factory Replacement Units (FRU)



Certification Mark

This product complies with the following EC Directives:
Electro-Magnetic Compatibility Directive.
(EMC) (2004/108/EC)
Low Voltage Directive.
(LVD) (2006/95/EC)

CE

Danfoss

Index

Installation

Product specification	3
Installation	4-6
Wiring	6-9
Replacement	10-11

User

What is a timeswitch?	12
Your timeswitch	13
Resetting the unit	13
24hr or AM/PM display	14
Setting the Time and Day	14
Factory preset programmes	15
Changing the preset programmes	16
Setting the programme - 7 day	17-18
Setting the programme - 5/2 day	19-20
Running your programme	21
Temporary user overrides	22
Battery backup	23
Contact details	24

Installation Instructions

Please Note:

This product should only be installed by a qualified electrician or competent heating installer, and should be in accordance with the current edition of the IEEE wiring regulations.

Product specification

Specification	
Power supply	230Vac \pm 15%, 50 Hz
Switching action	1 x SPST, Type 1B
Switch rating	264Vac, 50/60Hz, 3(1)A
Setting/Running Accuracy	\pm 1 min./month
Power Reserve	Minimum 24 hours
Max. Ambient Temperature	45°C
Dimensions, mm (W, H, D)	102 x 136 x 47
Design standard	EN 60730-2-7
Control Pollution Situation	Degree 2
Rated Impulse Voltage	2.5kV
Ball Pressure Test	75°C

Specification

Installation

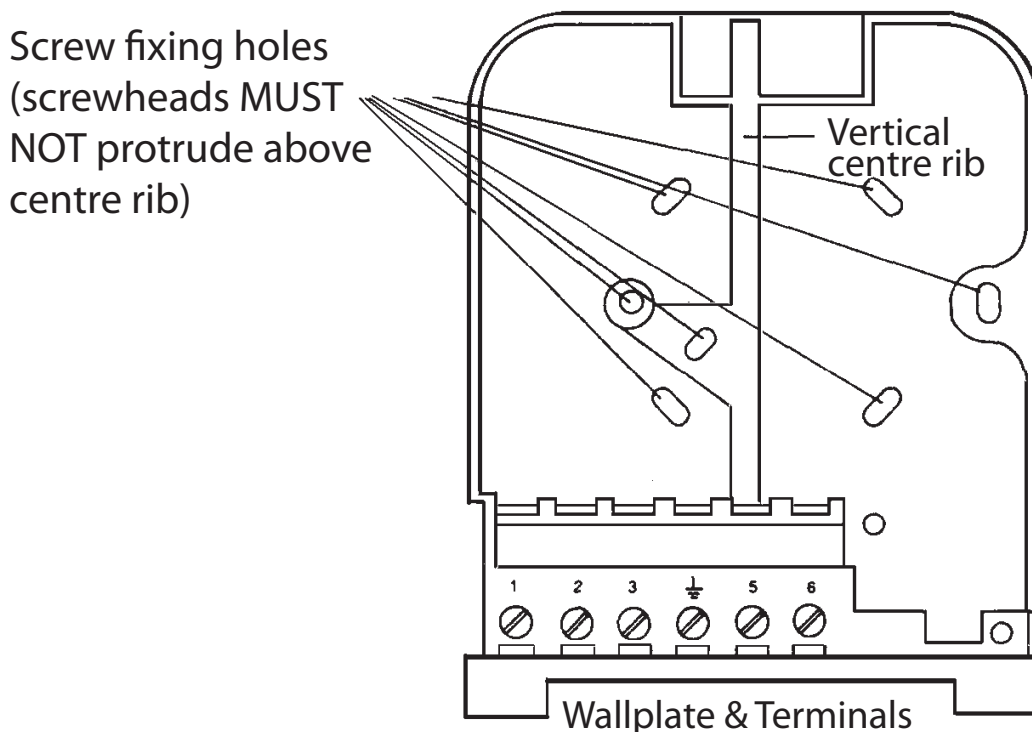

NB. For FRU units - go straight to point 6.

1. Loosen the fixing screw in the base of the unit to release the Wiring Cover.
2. Holding the unit face downwards, press firmly in the centre of the wallplate and slide it apart and lift it from the module.
3. Fix the wallplate and terminal block to the wall, or plaster box, as required. Ensure that the screw heads do not protrude beyond the vertical centre rib of the wallplate, or this will prevent the module correctly locating onto the wallplate.



4. Surface cables can only enter from below the unit. Cut an appropriate cable aperture in the wiring cover. If the wallplate is mounted on a plaster box, cables can enter from the rear below the terminal block.

- Electrical connections are simplified by using a Wiring Centre. However, if this is not used, the wallplate terminal identification is as shown.

Load			Mains Supply (via 3 amp fuse)		
ON	SPARE	COM		N	L
1	2	3		5	6

If the system being controlled is 230 Vac, then terminals 3 and L must be linked with insulated cable capable of carrying full load current. Whilst the unit does not require an earth connection, a terminal is provided on the wallplate for earth continuity purposes.

- Refer to the wiring diagrams on page 6-9, connect the unit as shown.
- Find out from the user whether the unit is required to operate in **7-day mode (factory preset)** or **weekday/weekend mode (5/2 day)**. To convert to 5/2 day mode remove the small two-way connector from the pins towards the left of the recess on the rear of the module, then press the button marked **R/S** under the flap to RESET the unit.
- Ensure all dust and debris are cleared from the area. Plug the module into the wallplate by locating it onto the wallplate and, when flush with it, sliding it down, ensure the hook at the top of the wallplate engages with the slot at the back of the module.
- Before setting the programme, check the unit and circuit. Press the **SELECT** button until the bar in the display lines up with the word **ON**. Adjust the remote thermostats to check the system operates correctly.

10. Then press the **SELECT** button until the bar lines up with the word **OFF** and check the system does not operate.
11. When the circuit check has been completed, replace the wiring cover and tighten the fixing screw. Cut any cable aperture in the wiring cover which may be necessary to accommodate surface mounted cables.
12. Finally set time of day and programmes required, noting that the unit is supplied with a pre-set programme, as stated on Page 15.

Wiring

Wiring

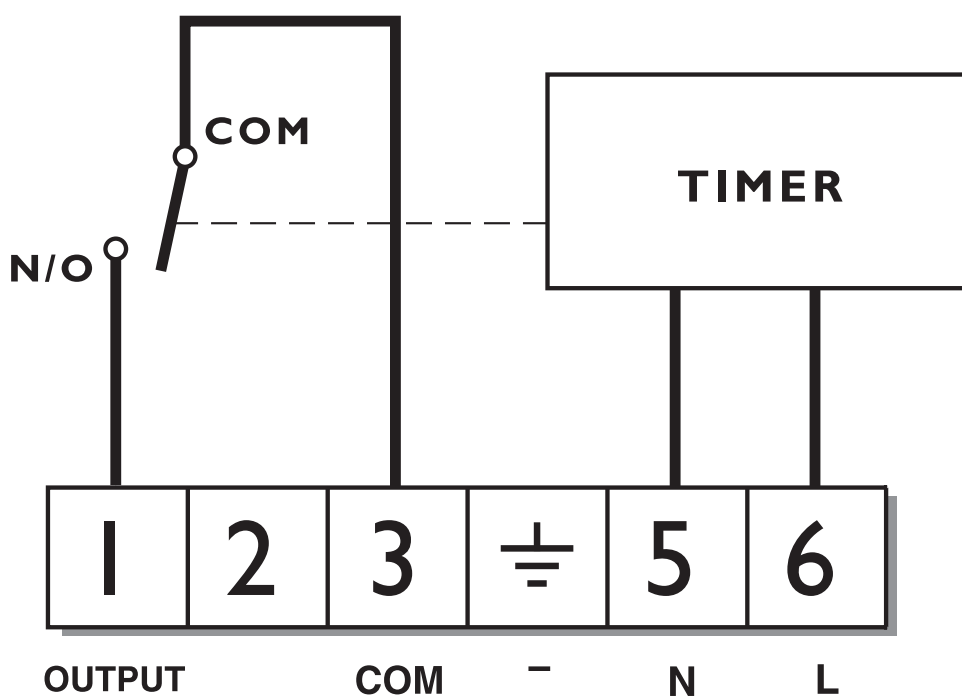

103, 103E5

Typical Gravity DHW with pumped heating

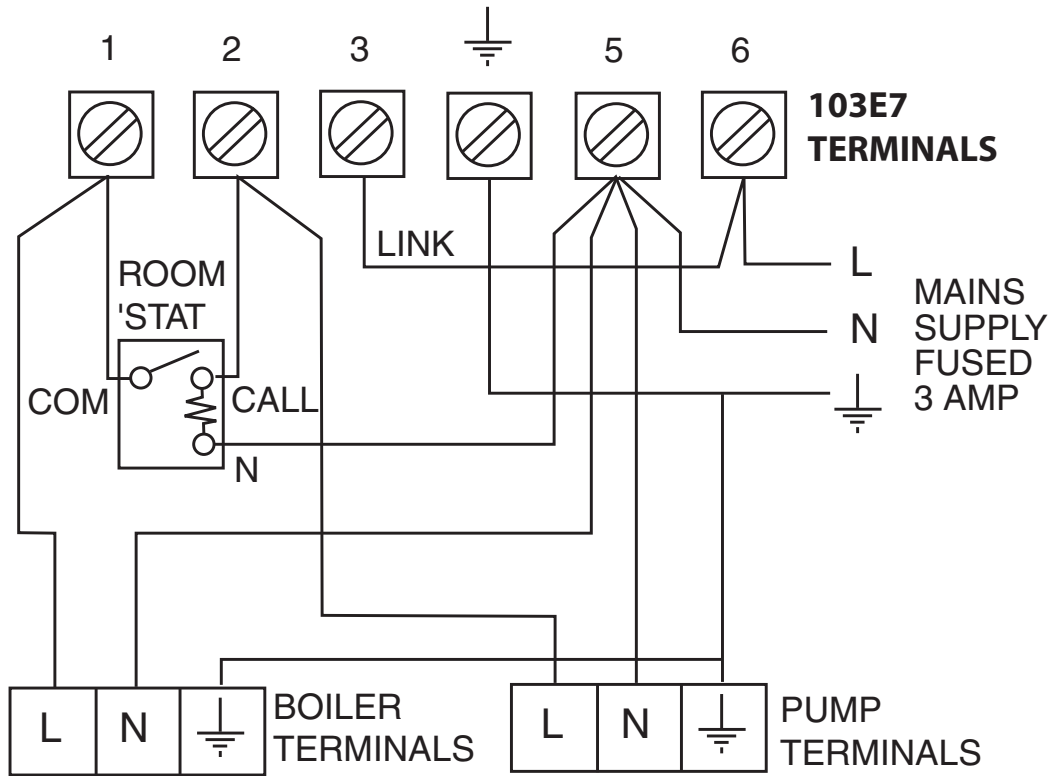

Typical control of Pump for Central Heating on a Solid Fuel System

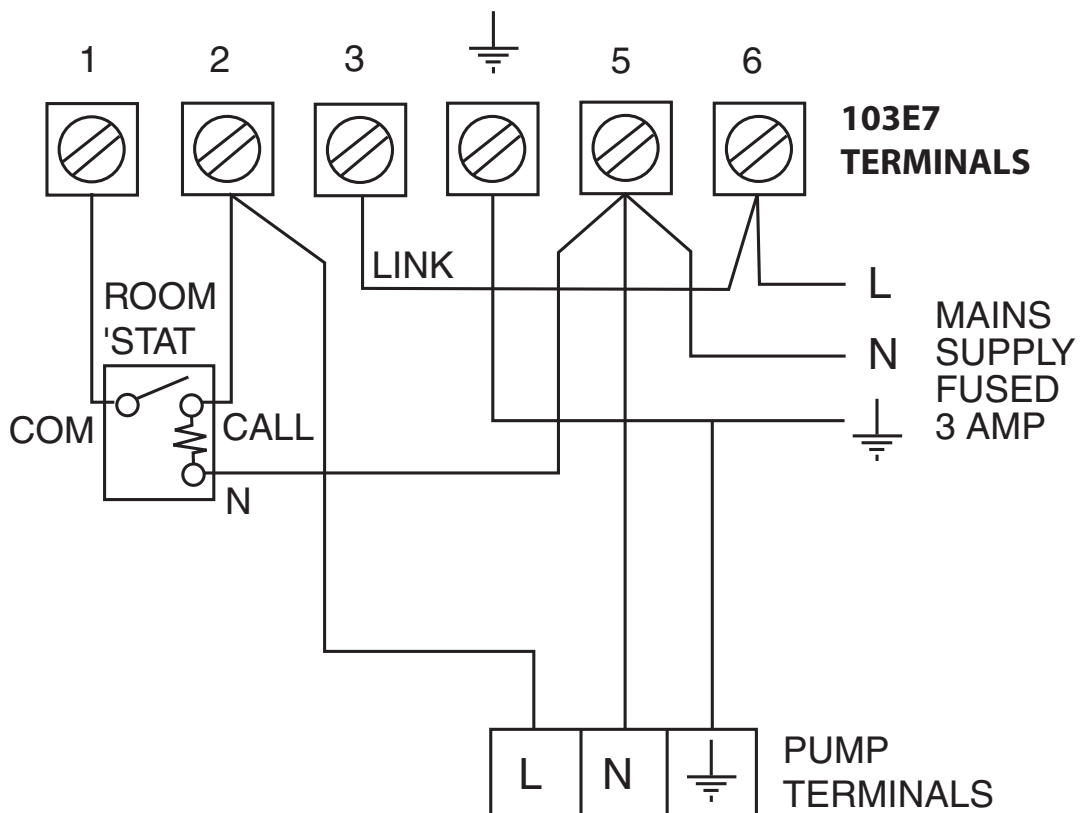

Typical Heating Only system, Boiler and Pump control

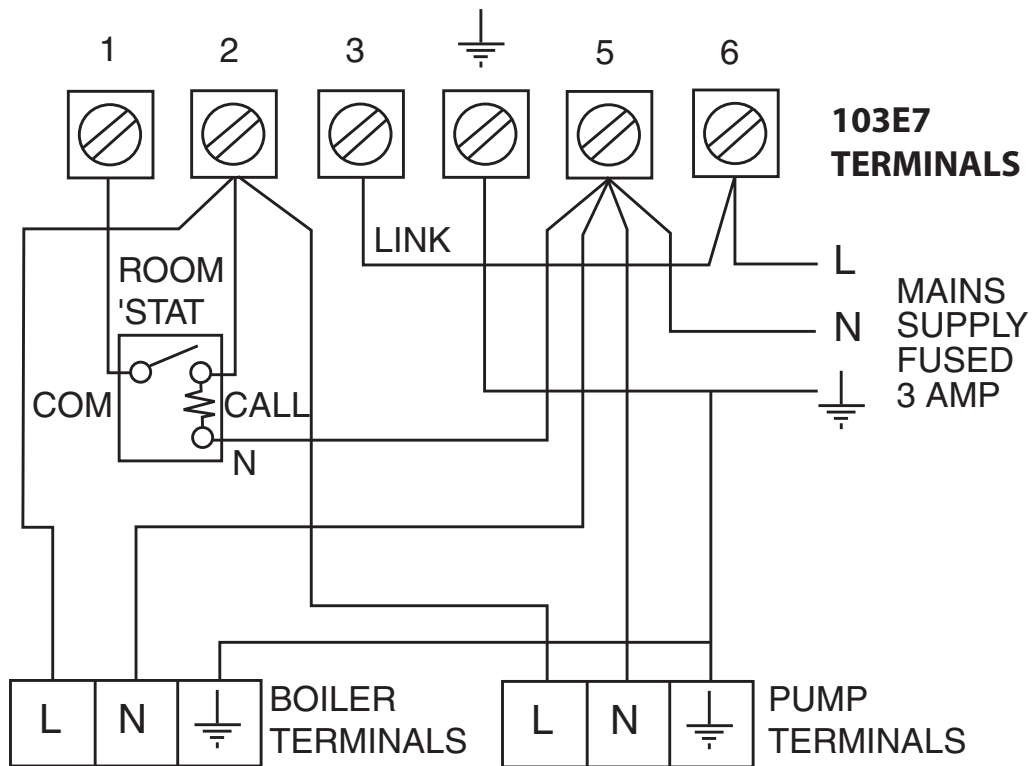

Typical control of Low Voltage System requiring voltage free contacts

Wiring

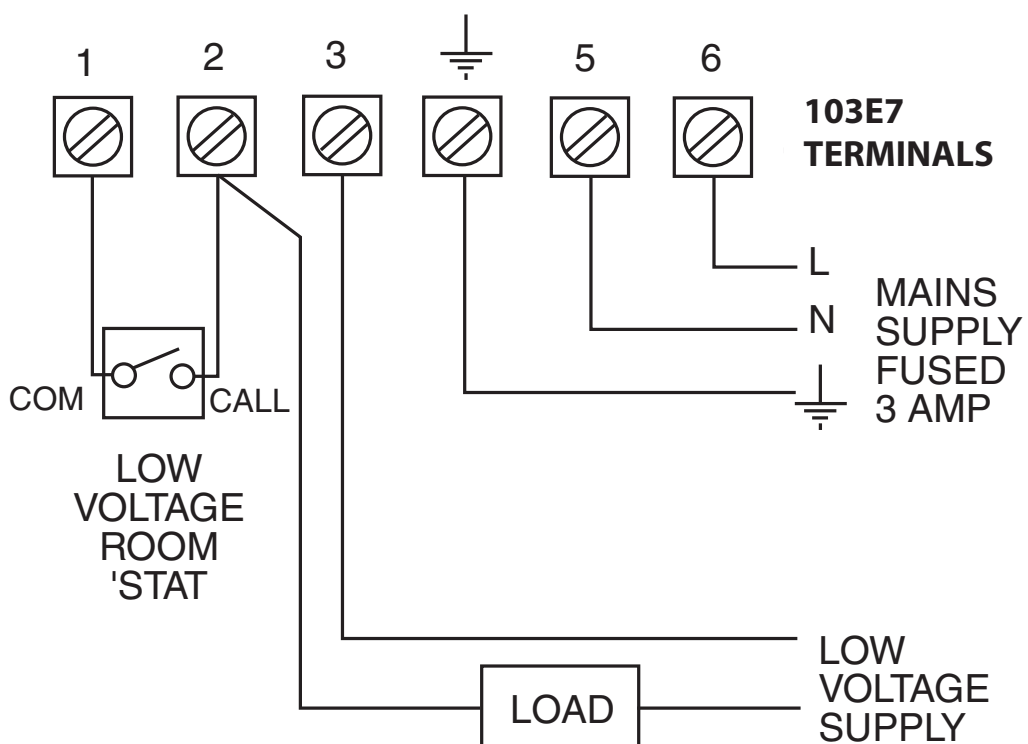

Typical control of Heating when provided by Combination type Boiler (see note below)

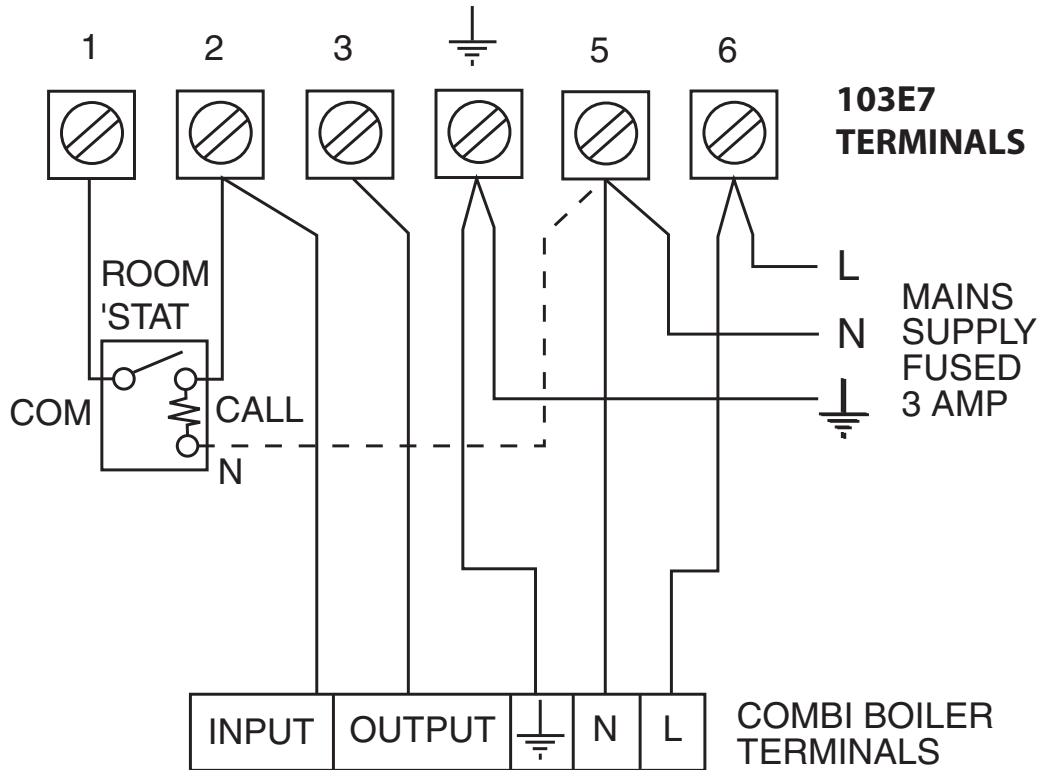





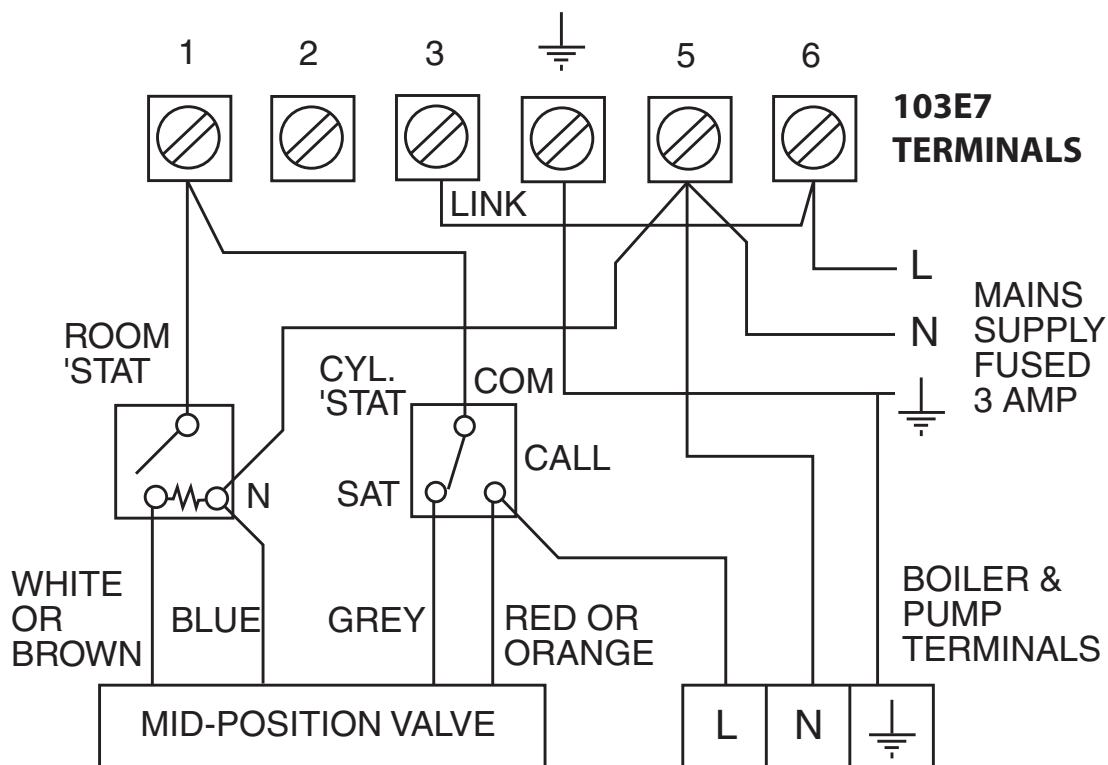



Note: Connection - - - - - must only be made if input/output of boiler are 230V signals

Typical Heating & Hot Water control system using 3 port mid-position valve



Replacement

DANFOSS RANDALL 103E7	LOAD			MAINS SUPPLY (via 3 amp fuse)	An additional terminal block is required where these disconnected leads (or pairs of leads) should be terminated			
	ON	SPARE	COM		A	B	C	D
	1	2	3	 5 (N)	6 (L)			
RANDALL 103, 103E, 103E7	1	2	3	 5	6			
RANDALL 3020	4	2	-	 1,7	6	5		
RANDALL TSR2	5	4	1	 3	2	7		
GRASSLIN 45, 45A, 45E	4	-	3	 2	1			
HORSTMANN 424 EMERALD & PEARL AUTO RANGE	4	2	3	 N	L,1	5		
HORSTMANN 423 PEARL, EMERALD & TOPAZ	4	1	3	 N	L	2	5	6
SANGAMO S254 Form 2, S408 Form 5, S251 Form 2	LOAD	-	-	 N	L			
SANGAMO S610 F2, S611 F2, S612 F2, S408 F4, S408 F6, S253 F2, S255 F2	LOAD	-	SWITCH LIVE	 N	MOTOR LIVE			

SANGAMO S409 Form 8	2	1	6	⎓	3,N	5,L	9	10	11
SANGAMO/RANDALL SET 1	4	2	5	⎓	N	L			
SMITHS IND. MKI, MKII	P3	P1	P2	⎓	N	L			
SMITHS IND. CENTROLLER 30	4,5	3	-	⎓	1	2	6		
SMITHS IND. CENTROLLER 40	4,5	3	-	⎓	1	2			
SWITCHMASTER 300	1	2	4	⎓	N	L	3		
TOWERCHRON TC	7	3	4	⎓	2	1	8	9	10
VENNER VENNERETTE MKIIA	LOAD	-	LINE	⎓	N	L			
VENNER VENNERETTE MKIVA	1	-	4	⎓	2	3			
VENNER VENNERON P	4	-	1	⎓	3	2			

TACMA

THE ASSOCIATION
OF CONTROLS
MANUFACTURERS



The text below has been edited and approved by the Plain English Campaign, who has issued a Crystal Mark to be displayed with it.

What is a programmer?

... an explanation for householders.

Programmers allow you to set 'On' and 'Off' time periods. Some models switch the central heating and domestic hot water on and off at the same time, while others allow the domestic hot water and heating to come on and go off at different times.

Set the 'On' and 'Off' time periods to suit your own lifestyle. On some programmers you must also set whether you want the heating and hot water to run continuously, run under the chosen 'On' and 'Off' heating periods, or be permanently off.

The time on the programmer must be correct. Some types have to be adjusted in spring and autumn at the changes between Greenwich Mean Time and British Summer Time.

You may be able to temporarily adjust the heating programme, for example, 'Override', 'Advance' or 'Boost'. These are explained in the manufacturer's instructions.

The heating will not work if the room thermostat has switched the heating off. And, if you have a hot-water cylinder, the water heating will not work if the cylinder thermostat detects that the hot water has reached the correct temperature.

Please note: A timeswitch is a single channel programmer. It will allow you to set your system's On and Off periods.

User Instructions

Your timeswitch

Your 103E7 timeswitch allows you to switch your heating and hot water on and off at times that suit you.

The 103E7 can provide 3 ON periods and 3 OFF periods each day and can offer either 7-day control (a different programme for each day of the week) or 5/2 day control (one set of programmes for weekdays and a different set for weekends).

Before you start/Making a Full Reset

- ❑ Open the flap on the front of the unit.
- ❑ Press and hold **+1HR** and **MAN** buttons.
- ❑ Press and release the **R/S** button using a small, non-metallic object (e.g. matchstick, biro tip)
- ❑ Release **+1HR** and **MAN** buttons.

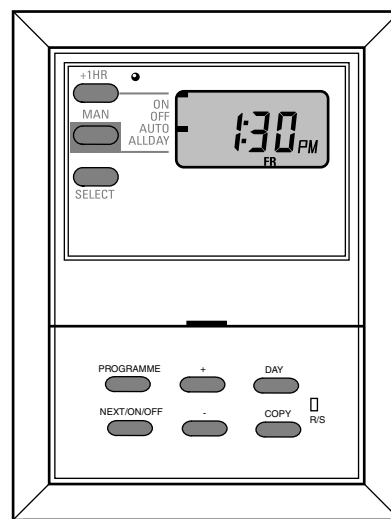

This will reset the unit and reinstate the preset programmes.

Choice of 24hr or AM/PM display

Press and hold **DAY** and **NEXT ON/OFF** buttons for 1.5 seconds to toggle between 24hr clock and AM/PM display, as required.

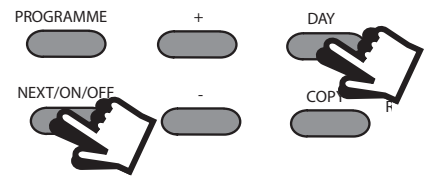

Setting the Date and Time

Setting the Date

Press and hold **PROG** for 5 seconds to display year.

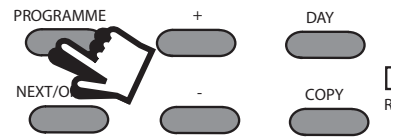

Use the + or - buttons to set the correct year.

Press **DAY** to display day and month. Use the + or - buttons to set the correct month (Jan=1, Feb=2 etc.).

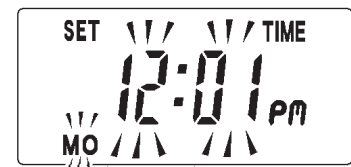

Press **DAY** to display day and month. Use the + or - buttons to set day of month.

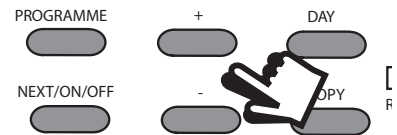

Press **PROG** to display the time.



The words **SET TIME** will appear at the top of the display and the time will flash on and off.



Use the + or - buttons to set the correct time (press and hold to change in 10 minute increments).

Setting the Day

The day of the week is set automatically. Press **PROG** to exit into **RUN** mode

Factory Presets

The unit is supplied with the following preset programme which will be active after the unit has been reset.

	Mon-Fri	Sat-Sun
1st ON	6.30am	7.30am
1st OFF	8.30am	10.00am
2nd ON	12.00pm	12.00pm
2nd OFF	12.00pm	12.00pm
3rd ON	5.00pm	5.00pm
3rd OFF	10.30pm	10.30pm

NB. 2nd ON and 2nd OFF are set to the same time. These 2 times are ignored by the programme therefore the heating will just come on once in the morning and once in the evening. If you want the heating to come on in the middle of the day set the 2nd ON and 2nd OFF to the times you require.

Accepting the preset times

If you are happy to use the settings above, you don't need to do anything else.



To accept the presets press the **PROGRAMME** button until the colon in the display begins to flash.

Your unit is now in **RUN** mode.

Changing the preset programmes

Your installer will have set your unit to operate in one of the following modes:

- ❑ **7 day** - different settings for each day of the week
(page 16-17) - **default setting.**
- ❑ **5/2 day** - one set of programmes for weekdays and another for weekends (page 18-19) .

! Please follow the correct instructions to programme your unit.

Please Note

The unit must be programmed in sequence and ON/OFF times cannot be set out of sequence.

If you want to leave a preset time as it is, simply press **NEXT ON/OFF** to move on to the next setting.

Your clock will allow you to programme 3 ON/OFF settings per day. If you do not wish to use one of the ON/OFF settings, simply programme the ON time to be the same as the OFF time and the setting will not operate.

! If at any time you get confused and need to reset your timings to the standard preset programme, press the **R/S** button to return to the preset programmes.

Programming the heating & hot water in 7-day mode

1. Press **PROGRAMME** until **SET ON TIME** appears at the top of the display and press **DAY** until **MO** appears at the bottom of the display.

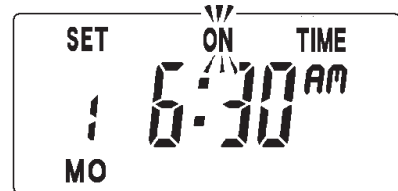
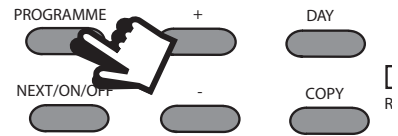

Use the + and - buttons to set the time you want your heating to first come on in the morning (Event 1).

2. Press **NEXT ON/OFF** to move to Event 2.

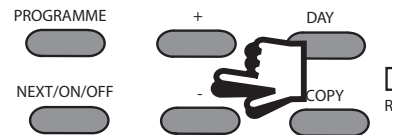

Either press **COPY** to use the same settings as the day before or continue to programme the central heating ON and OFF times, using the + and - buttons to set the time you want and pressing the **NEXT ON/OFF** button to move to the next setting.

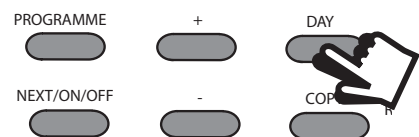
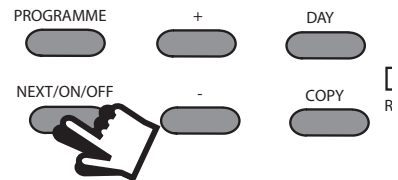

3. Press **DAY** button once only. **TU** will appear at the bottom of the display.

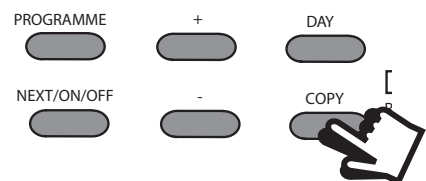

Continue programming the rest of the week by pressing:

a) **NEXT ON/OFF** button to move to the next setting,

b) **+** and **-** buttons to amend the time,

c) **DAY** to advance to the next day.

Alternatively press **COPY** to keep the same settings as the day before.

4. Press the **PROGRAMME** button to return the unit to **RUN** mode.
5. **Proceed to page 21.**

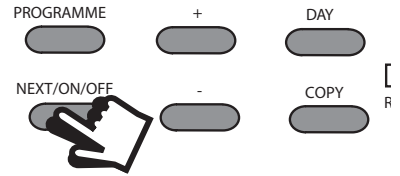

To advance to next time setting

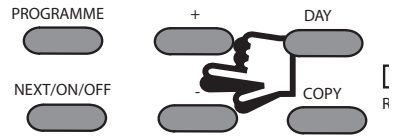

To amend **TIME**

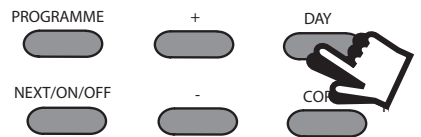

To move to next **DAY**

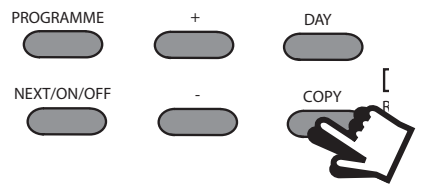

COPY previous event times

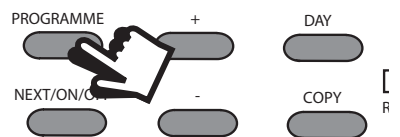

Return to **RUN** mode

Programming the heating & hot water in 5/2 day mode

1. Press **PROG** until **SET ON TIME** appears at the top of the display and press **DAY** until **MOTUWETHFR** appears at the bottom of the display.

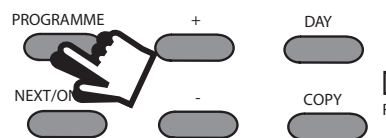

Use the **+** and **-** buttons to set the time you would like your heating/hot water to first come on in the morning (Event 1).

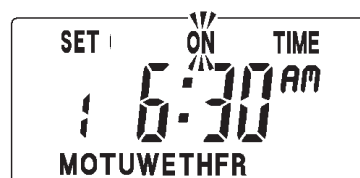

2. Press **NEXT ON/OFF** once only.

Use the **+** and **-** buttons to set the time you want your heating/hot water to go off (Event 2).

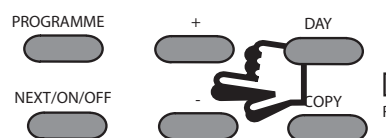

To move to the next setting, i.e. when you would like your heating/hot water to come on again (Event 3) press the **NEXT ON/OFF** button again.

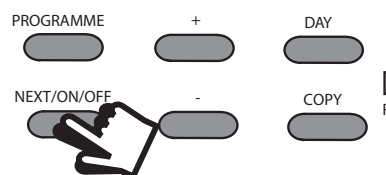

3. Continue programming the heating/hot water ON and OFF times for weekday Events 4, 5 & 6 as in Step 2.

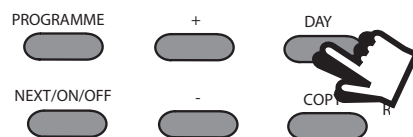

4. Press the **DAY** button once and **SASU** will appear at the bottom of the display.

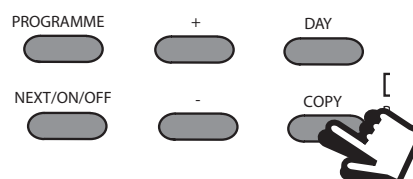

Either press **COPY** to keep the same settings for Saturday and Sunday as you have programmed for Monday to Friday.

Alternatively, programme new ON/OFF times by pressing the **NEXT ON/OFF** button to move to the next setting and using the **+** and **-** buttons to set the time you want.

5. Press the **PROG** button to return the unit to RUN mode.
6. **Proceed to page 21.**

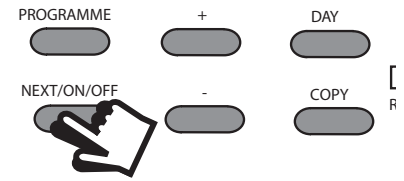

To advance to next time setting

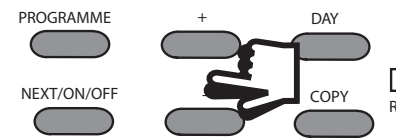

To amend **TIME**

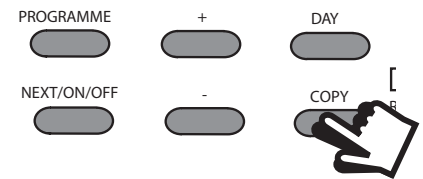

COPY previous event times

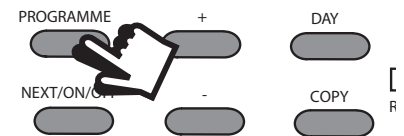

Return to **RUN** mode

Running your programme

The 103E7 controls your hot water and heating together, turning them on and off at the same times.

To run the central heating and hot water programme press the **SELECT** button.

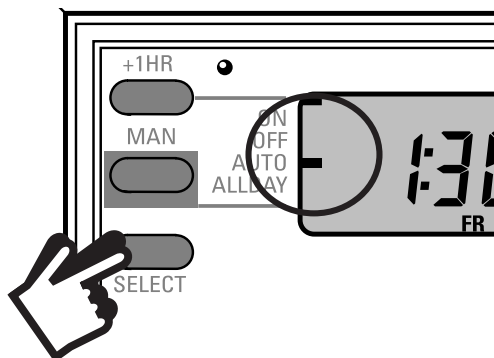

As you press **SELECT** a bar on the display will move between **ON**, **OFF**, **ALLDAY** and **AUTO**.

- **ON** = the hot water/heating will remain on constantly.
- **OFF** = the hot water/heating will not come on.
- **AUTO** = the hot water/heating will come on and go off according to the programmed times.
- **ALLDAY** = the unit will come on at the first programmed ON and will remain on until the last programmed OFF.

RUN mode

Select the option you require, depending on your circumstances, time of year, etc.

Temporary User Overrides

Sometimes you may need to change the way you use your heating temporarily, i.e due to unusually cold weather. The 103E7 has two convenient overrides which can be selected without affecting the set programme.

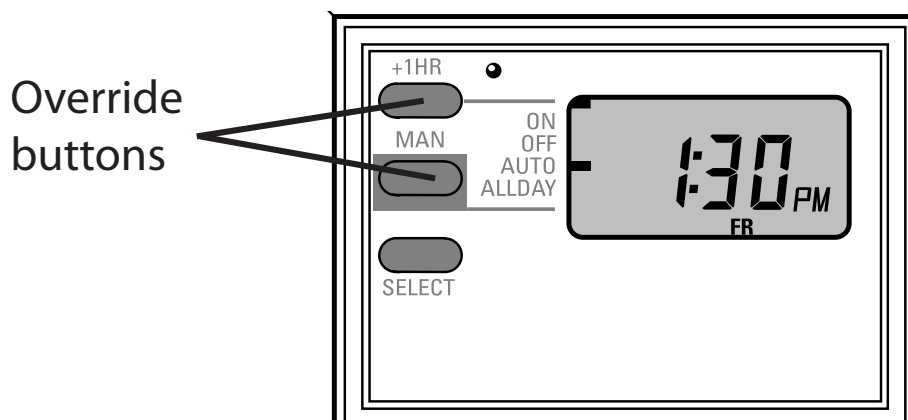

+1HOUR

- ❑ Press **+1HOUR** once if you need **an extra hour of operation**

If the system is off it will come on for an hour. If it is already on it will add an extra hour so the system stays on for an extra hour.

To cancel the override press **+1HOUR** again. Otherwise the override will self-cancel at the next programmed event.

MAN

- ❑ Press **MAN** button once to manually override the programme (only whilst unit is set to **AUTO** or **ALLDAY**)

*If the system is on it will go off. If it is off it will come on. The set programme will resume at the next programmed **ON/OFF** time.*

To cancel the override press **MAN** again.

Battery backup

In the event of a power cut, the built-in battery will keep your time and programme settings for up to 2 days.

After 2 days without mains power the date and time will be lost.

When mains power is restored, the unit should be **RESET**, by pressing the **R/S** button beneath the flap, using a small non-metallic object, i.e. matchstick, biro tip (see page 13).

Then reprogramme the date and time.

Still having problems?

Call your local heating engineer:

Name:

Tel:

For problems relating to your heating controls ...

Visit our website:

www.danfoss-randall.co.uk

Email our technical department:

drl_technical@danfoss.com

Call our technical department

0845 121 7505
(8.45-5.15 Mon-Thurs, 8.45-4.45 Fri)

**For a large print version of these instructions
please contact the Marketing Services
Department on 0845 121 7400.**



Danfoss Randall Ltd
Amphill Road
Bedford
MK42 9ER
Tel: 01234 364621
Fax: 01234 219705

