

**H-piece valves type RLV-K  
for valve radiators**



- with adjustable radiator share for one-pipe and two-pipe systems
- blockable and drainable



**Application**

By means of the H-piece valve type RLV-K, every valve radiator with a centre distance between the connections of 50 mm can be blocked individually, e.g. in order to carry out trouble-free maintenance without affecting other parts of the system.

H-piece valve type RLV-K is nickel plated and is available in straight and angle versions. Special adapters ensure that the H-piece valve can be used both for radiators with an internal thread of G 1/2 and with an external thread of G 3/4 A. All adapters are self-sealing.

RLV-K can be shifted from two-pipe to one-pipe operation. The factory setting is for two-pipe operation.

In one-pipe operation, the water flow to the radiator can be set infinitely variably. The shift to one-pipe operation is simply done by turning the bypass spindle.

A fill and drain tap is available as an accessory to RLV-K. The fill and drain tap is only available without nickel plating.

Connection to copper, soft steel, PEX and Alupex pipes is made with Danfoss compression fittings. See separate datasheet.

In order to avoid deposition and corrosion, the composition of the hot water should be in accordance with the VDI 2035 guideline (Verein Deutscher Ingenieure).

**System**

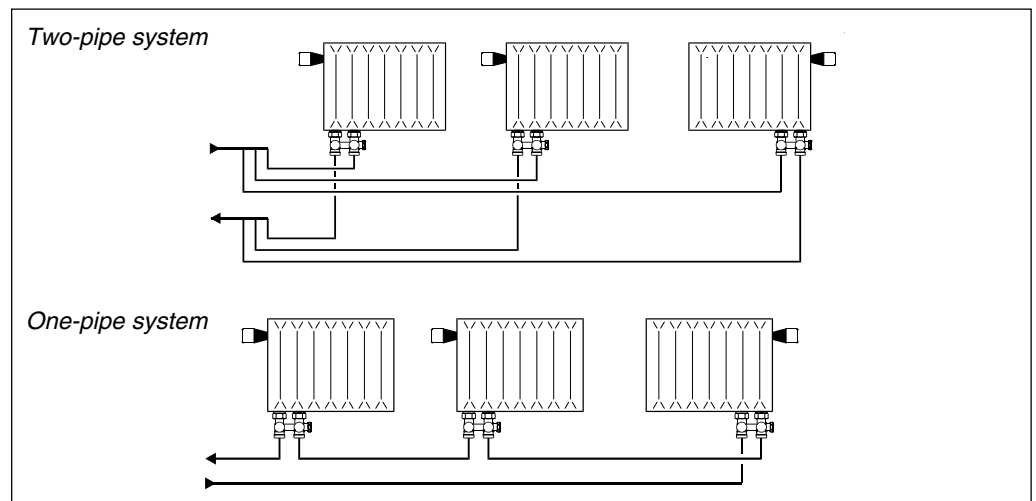

**Ordering and data**

Type	Version	Connection		Max. operation pressure	Test pressure	Max. water temperature	Code no.
		Radiator	System				
RLV-K	Angle	G 1/2 A	G 3/4 A	10 bar	16 bar	120 °C	003L0282
	Straight						003L0280
	Angle	G 3/4	G 3/4 A				003L0283
	Straight						003L0281

Accessories

Product		Code no.
Fill and drain tap without nickel plating, with 3/4" external thread and hose nozzle		003L0152
Adapter <sup>1)</sup> incl. seal for valve radiator with G 3/4 A external thread		003L0294
Self-sealing connection nipple <sup>1)</sup> for valve radiator with G 1/2 internal thread		003L0295
Convection brake <sup>1)</sup> for one-pipe systems		003L0296

RLV-K is suitable for connecting copper, soft steel or plastic pipes. Use Danfoss compression fittings.

<sup>1)</sup> Packing size = 20 pcs.

Capacity

RLV-K	Radiator share	k <sub>v</sub> -value (m <sup>3</sup> /h)					
		100% <sup>2)</sup>	50%	35%	30%	25%	20%
RLV-K	k <sub>vs</sub> -value	1.4	1.8	2.0			
RLV-K with RA-N integrated valve <sup>1)</sup>	k <sub>v</sub> -value <sup>3)</sup>	0.7	1.2	1.5			
RLV-K set to 35% with RA-N integrated valve <sup>1)</sup>	k <sub>v</sub> -value				1.4	1.3	1.2
	Presetting value	N	N	N	6	5	4

<sup>1)</sup> Radiator flow in accordance with the setting of the bypass regulation with radiator and Danfoss integrated valve, type RA-N.

<sup>2)</sup> Factory setting = two-pipe operation.

<sup>3)</sup> The k<sub>v</sub>-values give the flow volume (Q) in m<sup>3</sup>/h through the RLV-K union in combination with a Danfoss built-in valve with k<sub>v</sub> = 0.87 m<sup>3</sup>/h at X<sub>p</sub> = 2 K.

Setting of bypass regulation in one-pipe operation

The factory setting RLV-K is for two-pipe operation. This means that the integral bypass regulation is turned off.

Shifting to one-pipe operation is made by opening the bypass spindle. The radiator share (flow) can be adjusted infinitely variably.

The connection between flow and number of turns can be seen from the diagram next to this text (at setting "N" of the Danfoss integrated valve and at X<sub>p</sub> = 2 K).

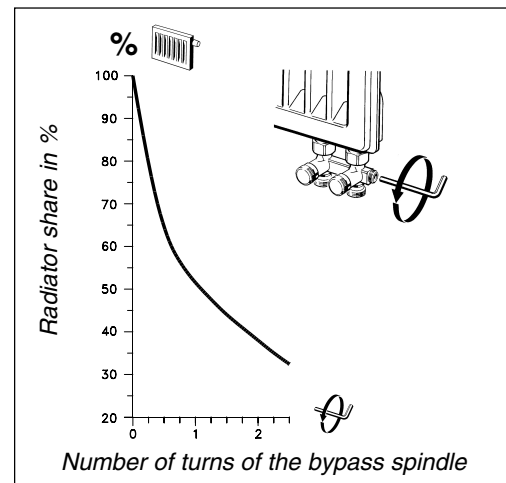

Draining of the radiator

To drain the radiator, first unscrew the cover caps. Then shut-off the inlet and return flow. When the drain tap has been mounted, open it by turning the square (see ill.).

The accompanying hose nozzle can revolve in any direction.

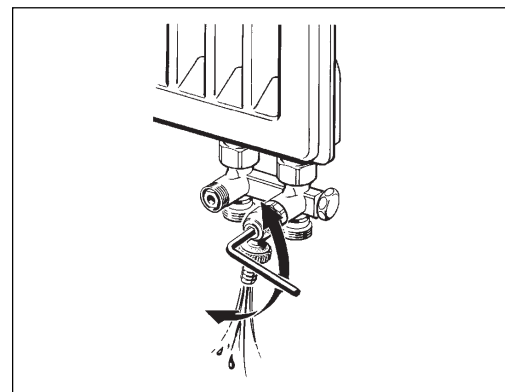

Design

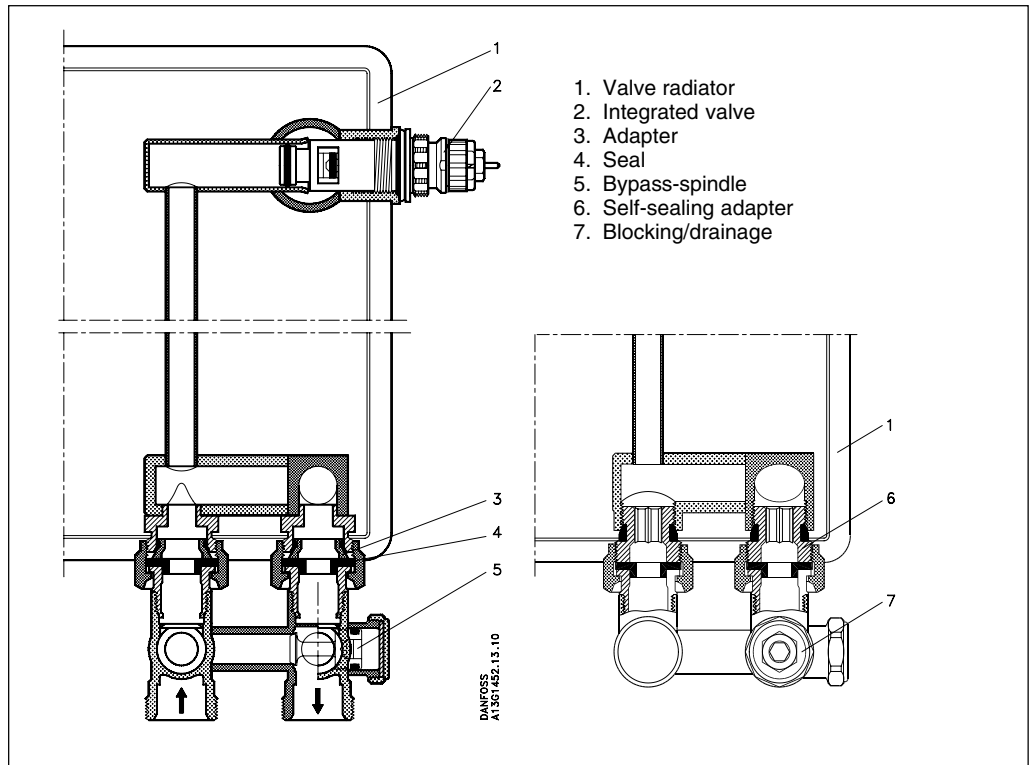

Materials in contact with water

Valve body and other metal parts	Ms 58
O-rings	EPDM

Dimensions

RLV-K straight, G 1/2 radiator connections

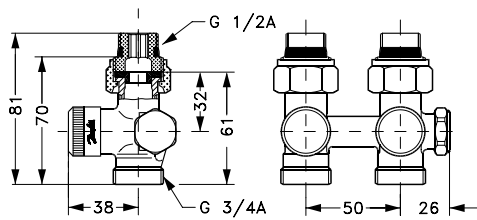

RLV-K angle, G 1/2 radiator connections

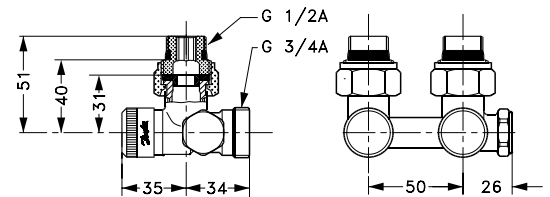

RLV-K straight, G 3/4 radiator connections

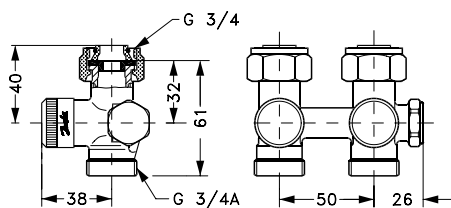

RLV-K angle, G 3/4 radiator connections

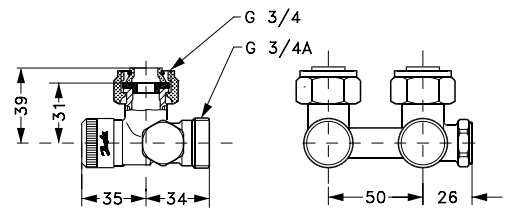

---

Danfoss can accept no responsibility for possible errors in catalogues, brochures and other printed material. Danfoss reserves the right to alter its products without notice. This also applies to products already on order provided that such alterations can be made without subsequential changes being necessary in specifications already agreed. All trademarks in this material are property of the respective companies. Danfoss and the Danfoss logotype are trademarks of Danfoss A/S. All rights reserved.

---

