

CELTIC 2.24 RSc

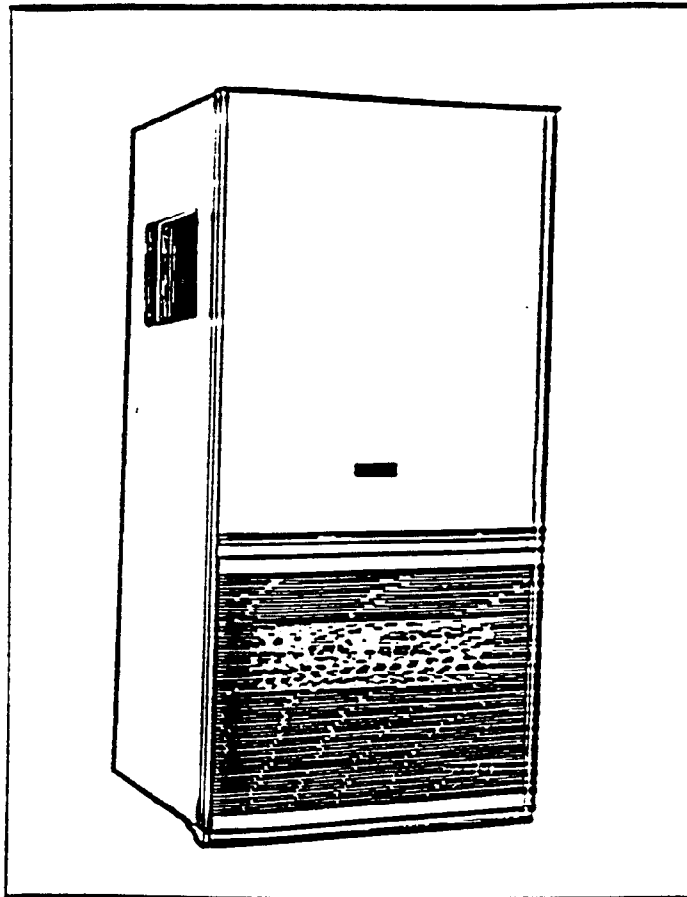

MANUFACTURER NO.

MODEL TYPE

GAS COUNCIL NO.

9226931.02
9226931.03

CELTIC 2.24 RSc NAT
CELTIC 2.24 RSc NAT

47 980 03

9226921.02
9226921.03

CELTIC 2.24 RSc LPG
CELTIC 2.24 RSc LPG

Installation and Servicing Instructions

(leave these instructions with the user)

The model and serial number are on the data badge located on front combustion chamber panel below expansion vessel. These numbers should be used when ordering replacement parts.

**Chaffoteaux
et Maury**



Looking Good. Heating Better

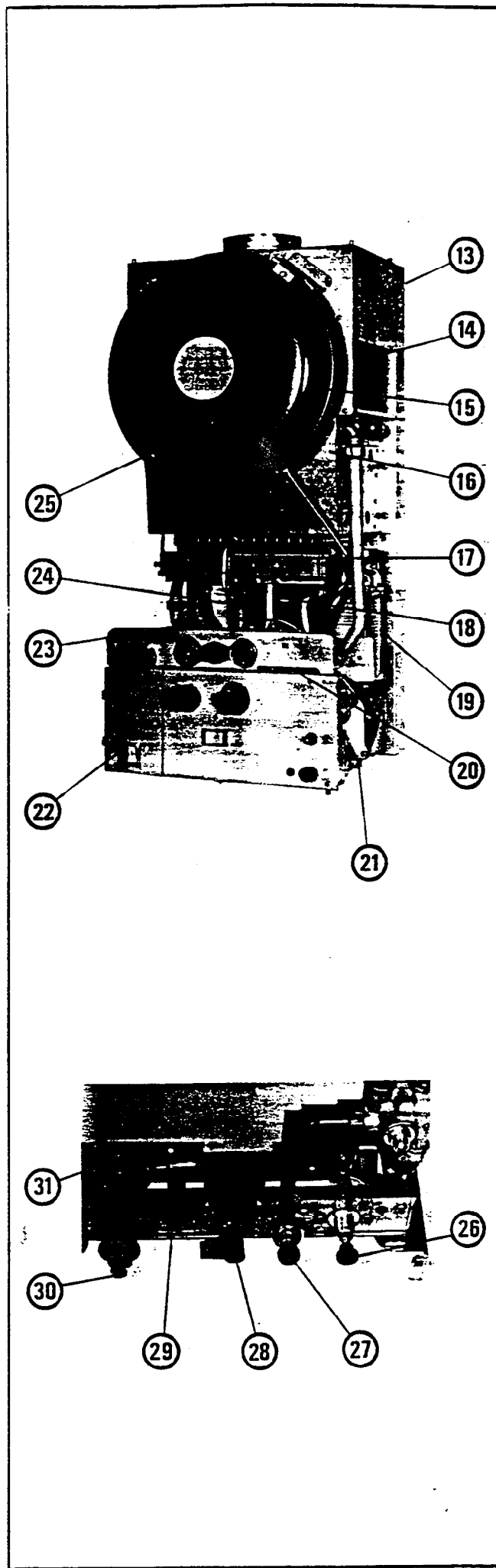
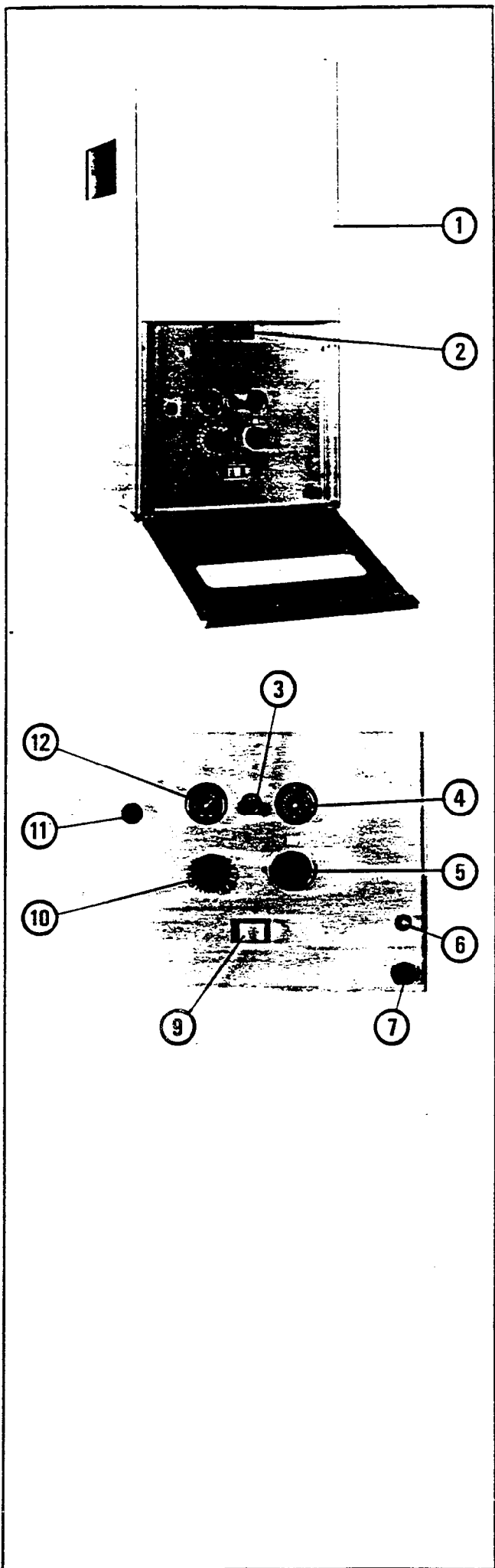

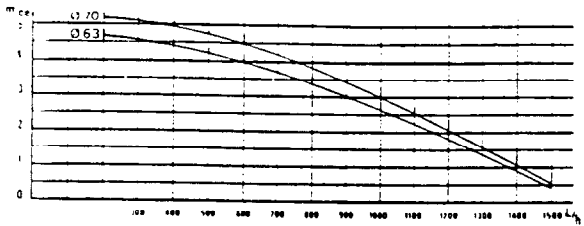

Fig. 5

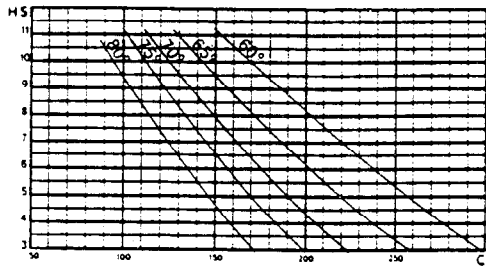

Fig. 6

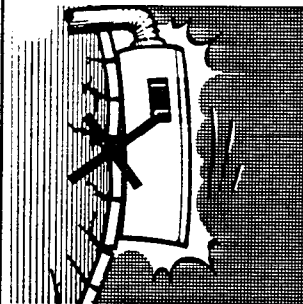

Fig. 7

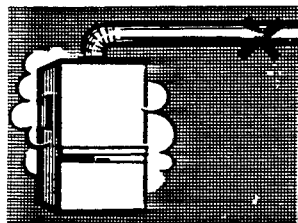

Fig. 8

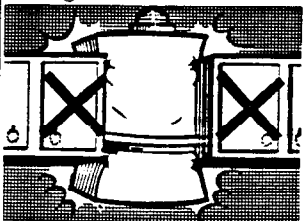

Fig. 9

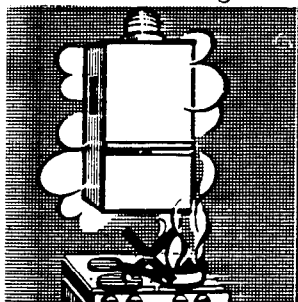

Fig. 10

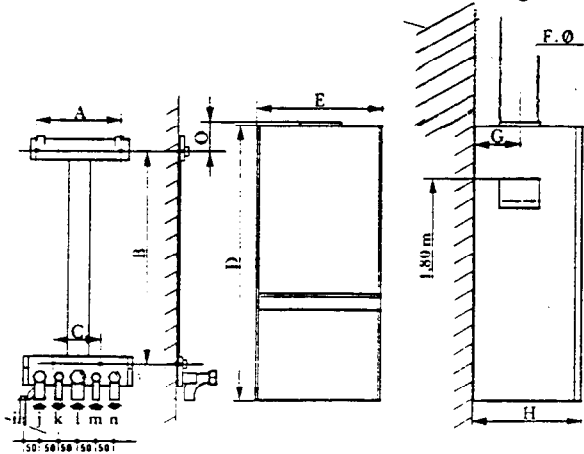

Fig. 11

	2.24		2.24		2.24
A	260	D	820.5	G	151
B	650	E	481	H	365.5
C	150	F	139	O	118

A) Screws to be found in accessories pocket-case.

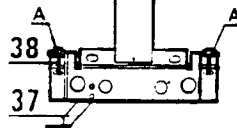
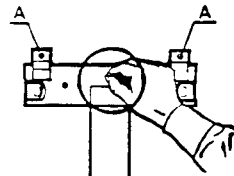

Fig. 12

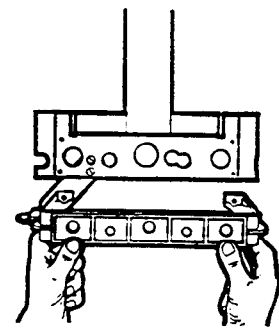

Fig. 13

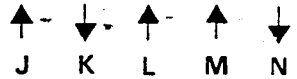
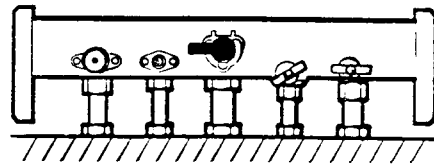
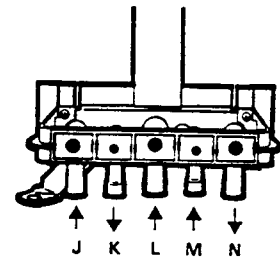

Fig. 14

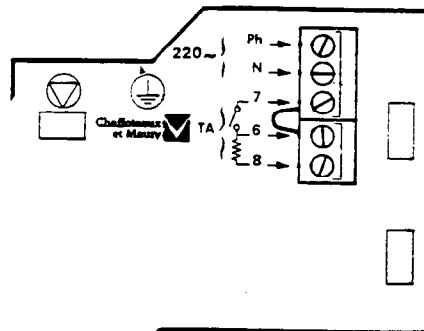

Fig. 15

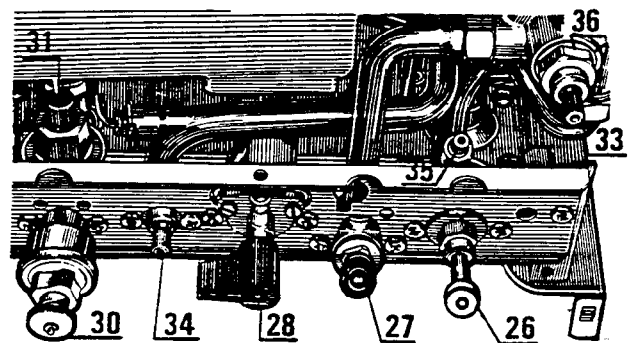

Fig. 16

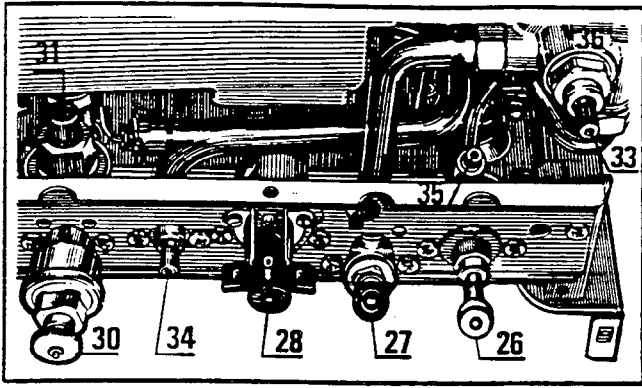

Fig. 17

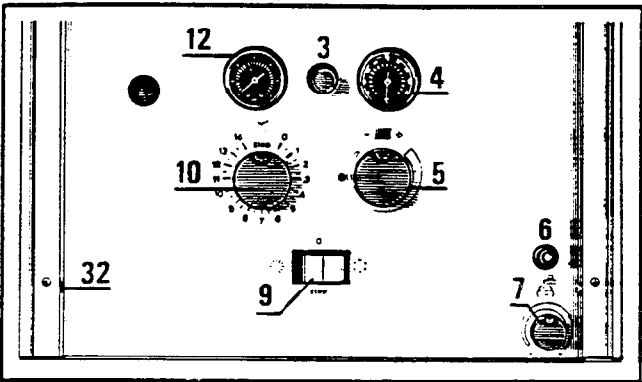

Fig. 18

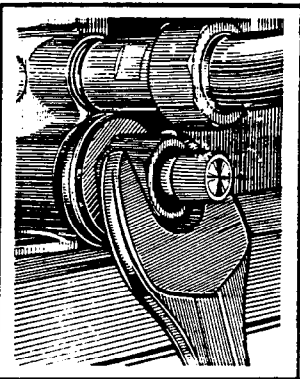

Fig. 19

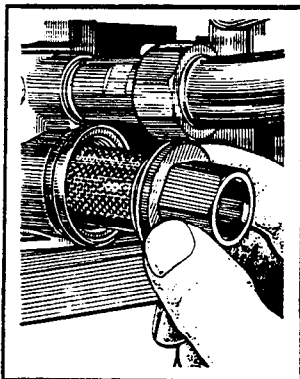

Fig. 20

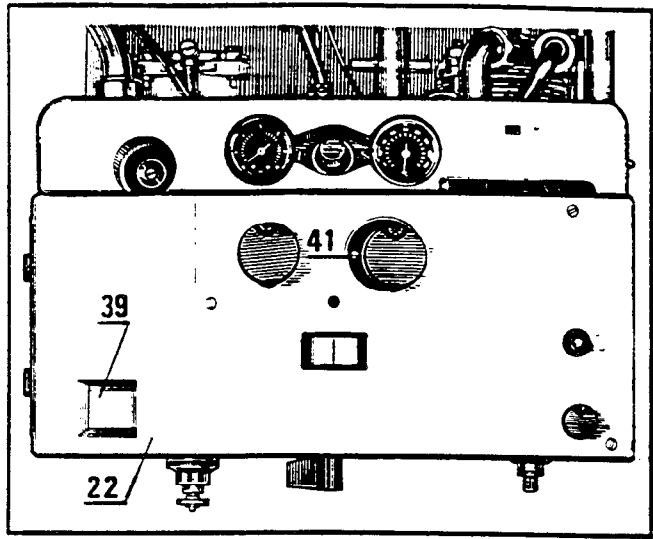

Fig. 24

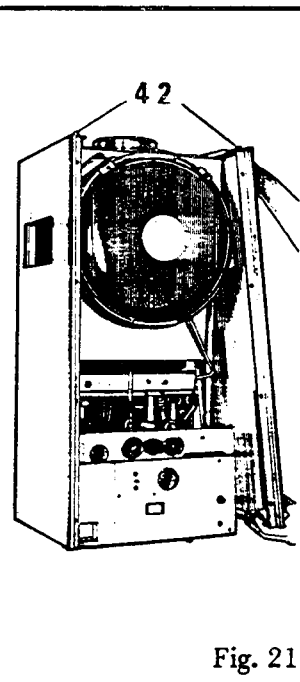

Fig. 21

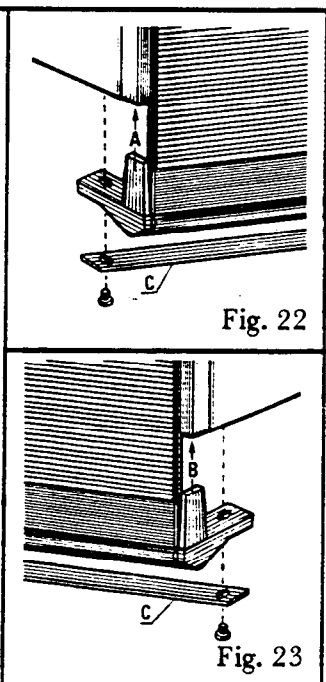

Fig. 22

Fig. 23

PUTTING INTO SERVICE

lighting

- Turn gas service tap to left to sign (♠).
- With the left hand push in the pilot button (3) (fig. 18). With the other hand push the ignitor button (6) (fig. 18). When the pilot light is established hold the pilot button pushed in for 30 seconds.
- (If lighting for the first time it may take a short time to clear the air from the gas pipe before gas is available at the pilot).
- Gently release the pilot button. If the pilot does not hold repeat this procedure again until the pilot is maintained.
- Check that the heating isolating valve (26) (fig. 17) is open.
- Switch the main electric switch (9) (fig. 18) to start the pump. The firing of the main burner is initiated by the starting of the pump.
- SUMMER (hot water only) place the switch in the ☉ position and open a tap.
- WINTER (heating and hot water) put the switch into position ☾. Set the room thermostat to the required temperature and the timer on the boiler to STOP.

How your boiler works

1) Production of hot water

Your boiler is designed to give hot water at a temperature of 60° C. with the temperature selector on +, (7) (fig. 18), when a tap is turned on. The maximum flow rate will be : 6 l/min (1.32 gpm) for the 2.20 RSc unit and 8 l/min (1.75 gpm) for the 2.24 RSc unit. It is possible to obtain higher water volumes at lower temperature - to fill a bath for example, turn the temperature selector to the sign - and open the bath tap fully.

Remarks : It is possible to leave the temperature selector on + and to reduce the temperature at the outlets by mixing cold water through a mixing valve, particularly for showering and washing. In this case the boiler will operate on its thermostat and may not come onto full gas rate, the boiler will also cycle on/off.

Note : When in hot water only mode the temperature on the temperature gauge on the boiler will be about 90° C.

2) Heating

Your boiler automatically adjusts the boiler output to the heating. The boiler thermostat acts directly on the gas control, it is normal for the burner to stay alight for long periods but the flame will modulate.

controls

1) Installation without a room thermostat (not recommended)

Set the boiler thermostat 5 (fig. 18) on the boiler as a function of the external temperature and the required internal temperature.

To increase the temperature turn the control to +, to reduce the temperature turn to -.

2) Installation with a room thermostat

- Set the control on the room thermostat to the desired temperature.
- The room thermostat automatically controls the firing of the boiler to achieve the chosen temperature.
- In cold weather the boiler thermostat (5) (fig. 18) can be left in the position +.
- In warm weather it is recommended that the thermostat is set to an intermediate position.
- The room thermostat will ensure that a uniform internal temperature is obtained.

To turn off the heating

- Put the control switch (9) (fig. 18) to the summer position « ☉ ». The boiler will now operate only on hot water demand.

To turn off the boiler

- Put the control switch to STOP.
- Turn off the gas by turning lever (28) (fig. 16).

To isolate heating during summer only

In some installations where the boiler is the lowest part of the system and the pipes rise vertically it is possible after the boiler has been operating continuously for a period to provide hot water to get a thermosyphon circulation in the heating pipes. One will first observe that the pipes are getting hot and eventually the first radiator will heat. This phenomenon can be annoying in summer.

- The heating flow is fitted with an isolating valve (26) (fig. 16) giving, in the above circumstances the ability to prevent the thermosyphon action in summer.
- When one switches to ☉ also close the isolating valve on the heating flow. **Do not forget to open the valve again at the start of the heating season when the control switch will be set on ☾.**

cleaning and servicing

The boiler should be cleaned and serviced annually. It is recommended that you enter into a service agreement with a competent, qualified installer. Chaffoteaux Ltd can assist with names and addresses of approved installers/service engineers.

Recommendations

- Your installation will not function correctly unless it is absolutely free of air and full of water.
- It is normal that the pressure shown on the pressure gauge will be lower when the water is cold than when it is hot.
- If the pressure on the pressure gauge (12) (fig. 18), falls below 1 bar when cold re-pressurise the installation as follows.
- Put the switch to STOP.
- Open the fill valve
- When pressure is about 1.5 bar (12) (fig. 18) close the fill valve.
- Return the switch to its original position.

Note : it is possible after filling for a small amount of water to be expelled from the safety valve when the water temperature rises. This is normal.

To remove the cover (fig. 18)

- Remove the thermostat knob (5), the timer knob (10), selector knob (7), by pulling towards you.
- Remove the six screws (32).
- Remove the cover.

Access to air purger

Remove the top front panel to give better sight of the purger and pass a screwdriver through the hole made for this purpose in the front cover.

Precautions in case of frost

1) Drain the hot water system

- Turn off the mains stop cock, open a hot water tap, and a cold water tap.
- Remove the drain screw (33) and (34) (fig. 16 and 17).
- To re-fill the system proceed in reverse order.

2) Draining the heating system

- Turn off the boiler by putting main switch to STOP.
- Leave the system to cool down.
- Open the valve on the safety valve (30) (fig. 16 and 17).
- Drain the system at all low points of the installation.
- Open the drain plug (35) (fig. 16 or 17).

To fill the system after draining. Close all the drain off points

- Close the drain plug (35) (fig. 16 or 17).
- Close the valve on the safety valve (30) (fig. 16 or 17).
- Open the fill valve and re-fill slowly, close the air vents on the circuits.
- When the pressure gauge shows a pressure of 1.5 bar close the fill valve.
- Check carefully all the air vents and or air purgers at high points on the installation.

Cleaning the domestic hot water filter, to be found in the control tap.

- Stop the boiler by switching the switch to STOP.
- Close the mains stopcock (27) (fig. 16 or 17).
- Unscrew the water regulator (36) (fig. 16 or 17), remove and clean the filter.
- Replace in reverse order.

Cleaning the heating system filter

A filter is incorporated in the return isolating valve on the left of the boiler. The obscuring of the filter will be evident by poor circulation in the radiators or a large temperature difference between the flow and return pipes. To clean the filter.

- Stop the boiler by putting switch to STOP.
- Close the isolating valves on the flow and return to the heating system (26) and (31) (fig. 16 or 17) by pushing in and turning.
- Open the valve of the safety valve (30) (fig. 16 or 17).
- Unscrew the head of the valve with a spanner (fig. 19).
- Take out the head of the valve with the filter (fig. 20).
- Clean the filter by brushing under running water.
- Replace in reverse order.
- Refill your boiler (see recommendation).

INSTALLATION INSTRUCTIONS

installation requirements

The system should be installed by a qualified competent installer. Our guarantee is dependent upon this condition.

The installation of the boiler must be in accordance with the Safety Regulations, relevant Building Regulations, I.E.E. Regulations and the Byelaws of the Local Water Undertaking. It should be installed in accordance also with the BS Rules of Practice and the British Gas Publication « Material Installation Specification for Domestic Central Heating Hot Water », and any relevant requirements of the local Region, Local Authority and Water Undertaking.

Particular:

The boiler must be installed in a room/compartment of not less than 8 m³. It must be connected to a proper flue.

The room must have proper provision for combustion and ventilation air in order to maintain the proper functioning of the boiler.

description

The casing is galvanised steel painted with a white synthetic resin baked on.

The permanent pilot and thermocouple flame failure will turn off the boiler if the pilot goes out.

Push button for pilot light.

Thermometer showing temperature of the water in the heating system.

Control valve and thermostat to control the temperature of the water in the heating system.

Push button on the piezo ignitor.

Hot water control valve.

Main switch SUMMER (☀) - STOP - WINTER (❄).

Delay timer 0-14 hours.

Opening to give access to pump head.

Pressure gauge to indicate the pressure in the heating system.

Chassis in steel. The various parts of the boiler are assembled on the chassis.

Draught diverter in steel coated.

15) In front of the draught diverter the expansion vessel is mounted. The expansion acceptance of the vessel varies according to the boiler output.

16) Heating body comprising a copper heat exchanger and a combustion chamber in coated steel and lined with a combustion ceramic.

17) Multigas burner comprising :
- burner in stainless steel
- manifold with injectors
- thermocouple flame failure

18) Gas valve assembly comprising :
- Thermoelectric valve
- A two stage gas valve giving full modulation and low flame/off.

19) Heat exchanger for domestic hot water.

20) Thermostatic valve comprising :
- A diaphragm valve
- A thermostatic element which allows the user to control the room temperature as a function of water temperature.
- Screw to adjust output on heating.

21) Change over valve controlled by a demand for domestic hot water. The heated water from the boiler is diverted from the heating system to the DHW heat exchanger.

22) Electrical control box which includes the printed circuit and fuses connections for a supply cable (twin and earth). The room thermostat can also be connected in the box.

23) Pump

24) Air purger and automatic air vent situated on the pump outlet.

25) Overheat thermostat

26) Valve on heating flow to prevent gravity circulation in summer.

27) Water service cock.

28) Inlet gas service cock.

29) Outlet connection for domestic hot water.

30) Safety valve with drain cock.

31) Heating return valve with filter.

An electric control thermostat set to 60° C controlling the outlet temperature of the domestic hot water. The thermostat acts directly on the pump which controls the boiler.

These features are patented.

hydraulic characteristics

(Fig. 5) shows the graph of the pump head available for the system.

The boiler is delivered with a pump fitted with a 63 mm impeller (for the 2.20 RSc) and a 70 mm impeller (for the 2.24 RSc model).

Characteristics of the expansion vessel

The expansion vessel, when fitted in front of the draught diverter, is for a sealed system. It maintains a pressure in the system and accepts the expansion of the water.

The expansion volume of the vessel is 5.4 litres.

Water volume in an installation (fig. 6)

Water content of a sealed system varies as a function of:

- the design flow temperature
- the static head of the system (this is the difference in height between the highest point on the system and the centre of the expansion vessel).

hs : static head of system in meters

c : water content of system in litres.

system requirements for boiler

The following are precautions to take:

- the boiler must be fitted on a fire resistant wall - light partitions should be avoided (fig. 7).
- it is necessary to fit a flue.
- a space of 6 in. (150 mm) shall be left free around the boiler to allow for the removal of the casing, to give access to components, for servicing and for the efficient operation of the draught diverter (fig. 9).
- do not fit the boiler above a cooker. The grease present in the atmosphere over the cooker will cause poor performance of the boiler.
- as this is an open flue appliance it cannot be fitted in a shower or bath room.

Recommendations to obtain the best performance from the installation

- The hot water installation should be in copper tube. The diameters should be calculated to avoid high resistances. It is recommended that taps of low resistance are used to permit an adequate flow rate. The pressure required at the inlet to the boiler must be minimum 1 bar in addition to the system resistance.

The water supply pipework should not have loose jumper washer on any stop tap or non return valves fitted.

The boiler must only be used in indirect systems with pipes in copper or black iron and where the heat emitters are copper (convectors), steel or cast iron. On no account should it be used with galvanised pipes or heating components.

If the system water is being treated it must not be aggressive or capable of promoting corrosion in the installation. Chaffoteaux Limited recommend Fernox CP3 inhibitor.

When replacing an old boiler it is strongly recommended that a strainer is fitted in the system return, the filter in the return valve is not sufficient.

Radiators with thermostatic radiator valves

When the boiler is fitted on a system where there are thermostatic radiator valves the following recommendations should be followed:

- leave at least one third of the load without thermostatic control.
- use a three port thermostatic valve to maintain the circulation in the system and in the boiler if possible.
- Avoid long runs to radiators in 8 mm or 10 mm tube.

fitting the boiler

Preparation

- use the mounting bracket as a template. The template will be found in the carton under the side panels.
- place in the position chosen for fixing the boiler. It is possible to make a provisional fixing using a nail (fig. 12). The mounting plate can then be levelled.
- mark the four fixing holes.
- remove the mounting plate.
- drill the fixing holes.
- using a rawplug or similar fit the mounting bracket using 6 mm x 50 mm wood screws.
- secure plastic templates (fig. 13) on the assembly jig by means of the 4 screws.
- place the various elbow sockets on the plastic templates (fig. 13). **This operation has to be done without the gaskets.** Take the best possible advantage of the rotating sockets: upward diffusion behind boiler, for instance, or downwards diffusion for distribution at baseboard level.

Gas and water connections	Diameter of pipes	Threaded connection size
J - Heating return	22,3 mm	3/4" BSP
K - Outlet hot water	15,1 mm	1/2" BSP
L - Gas inlet NG	/	3/4" BSP
- Gas inlet LPG	15,1 mm	/
M - Inlet domestic hot water	15,1 mm	1/2" BSP
N - Heating flow	22,3 mm	3/4" BSP

Pipe connections

Once the support is in place pipe joints can be made easily. Their position is fixed by the rigid securing of the outlet bends to the mounting bracket.

The various pipe connections can be made without removing the boiler or casing from the packing case, damage is thus avoided.

Important: the safety valve mounted under the return isolating valve protects the system against over pressurisation. It must be connected to a drain pipe in 22 mm tube. For this purpose a connection is supplied and a positioning bracket (37) (fig. 12). This pipe must not be soldered and the relief pipe must vent to atmosphere.

Do not forget to fit the plastic tube from the air purger on the braised connection nipple on this pipe.

Important: Before fitting the boiler in position on the support bracket it is strongly recommended that the systems is cleaned and flushed. Use a product to eliminate the grease and flux residues present after soldering the pipes. Filings and pieces of solder if entrained into the boiler will adversely affect its functioning.

Fitting the boiler

Lift the boiler and fix on the mounting bracket fixing points.

Check the position of the boiler

Check the boiler for level, adjustment can be made using the two levelling bolts (38) (fig. 12) situated on the lower support bracket so that the connections centre on the pipe connections.

The connections are now in place, tighten the nuts.

To simplify this special tools are available from Chaffoteaux Ltd (Consult our Sales Department).

Connecting the flue

2.20 RSc : 125 mm diameter - 2.24 RSc : 139 mm diameter.

When the appliance is set lower than maximum output for heating the flue size must still be calculated on the maximum boiler output.

electrical connections

The electrical control box requires :

a mains cable twin and earth supply.

Terminals are provided for the connection of a room thermostat.

The box has fuses fitted.

Connecting the boiler

- Take out the fuses (39) (fig. 24).
- Open the door on the box (22) (fig. 24).
- Cut the end of the cable entry to the size of the cable to be used.
- Connect the supply and earth cable.
- close the door (22) and put back in place the fuse holder (39) (fig. 24).

Function without room thermostat

In this case no modifications to the electrical box are necessary. The boiler will function on its own thermostat.

Connection of a room thermostat

Normal room thermostat : 2 wire.

- remove the link in the electrical box between terminals 6 and 7 and connect the room thermostat in their place (fig. 15).

Room thermostat with accelerator : 3 wire.

- Proceed as in 1 and connect the accelerator heater wire to terminal 8 (fig. 15).

Attention : take care in connecting the accelerator heater. It should not be live when the thermostat « breaks » on temperature rise. It may be necessary to reverse the connections 6 and 8.

putting into service

Hot water circuits

- Open the water service tap (27) (fig. 16 or 17).
- Purge the installation by opening the hot taps. Close the hot taps ; the hot water circuits are now filled.

Re-filling the heating circuits (figs. 16 and 17)

- Check that the isolating valves flow (26) and return (31) on the boiler are open. Also that the water service tap (27) is open.
- Fill the system as for normal sealed systems.
- Vent air from the air vents on the radiators and at high points on system where fitted.
- Close the fill valve when the pressure on the pressure gauge registers 1.5 bar.
- Open the vent on the air purger 1 turn.
- Start the pump by putting main switch to  winter.

The venting of the system may be assisted by repeated cycles as follows.

- start the pump for a few minutes - stop - vent.
- top up the system again if necessary and ensure that all the vents are closed.

regulating adjustments to boiler

Normal Gas - Propane - Butane (see table - page 9)

Do not adjust the input to the appliance.

It is possible to set the maximum output to control heating so that the output to central heating can approximate to the installed load thereby preventing noise which results from over-heating on heating only.

To regulate check that the boiler is operating at full gas rate. Adjust the screw (41) (fig. 24). (Screw in to reduce and out to increase). Regulate as required between full gas and 33 % of the nominal output. Check the gas input at the meter. After each movement of the regulating screw it is necessary to stop and start the pump by switching the main switch.

The boiler is supplied set to 75 % of the nominal output. This regulation does not effect the input of hot water which is not changed by adjustment of the input to central heating.

To check the functioning of the hot water

- Slowly open the hot water tap with the selector closed until the boiler lights. When the water is at temperature the boiler will cycle. The boiler will light on full gas and go out to maintain the water temperature at 60° C.
- Open the hot water tap fully and set the selector to maximum. The temperature should be approx. 40° C (cold water entering at 15° C).

fitting the casing

- 1) Take the control box cover, the glass door, the upper front panel and the side panels from the carton.
- 2) Assemble the pieces starting with the side panels (fig. 21). After these have been hung in position fix with screw at the bottom and screw in half way.
- 3) Put the control panel into the mounting position. Fit the 4 screws. Also the two screws. Also the two screws in the side panels.
- 4) Fit the top front panel by engaging in the top fixing turretts (42) (fig. 21) the two screws into the bottom section.
- 5) Put on the control knobs. Gas push knob, thermostat, delay timer, and hot water temperature selector.
- 6) The glass door is fitted with the aid of two fixing plates A and B a spacer bar C which must be used (figs. 22 and 23).
 - take out the two nuts which hold the spacer bar to the door fixing plates and keep the screws.
 - put the door in vertical position, the spigot A (fig. 22) in the profile of the left hand side vertical trim and fix the assembly in position.

Turn the right hand fixing plate 90° and engage the part B in the profile of the side panel trim. Fit the assembly to the right hand side panel (fig. 23).

	HEAT OUTPUT		HEAT INPUT		NATURAL GAS				PROPANE - LPG					
	kW	Btu/h	kW	Btu/h	BURNER PRES.		GAS RATE		BURNER PRES.		GAS RATE		GAS RATE	
					mbar	in wg	m ³ /h	ft ³ /h	mbar	in wg	m ³ /h	ft ³ /h	kg/hr	lbs/hr
Hot water 2.24 RSc ..	27.9	95195	33.6	114642	10.24	4.12	3.24	114.27	27.92	11.2	1.34	47.21	2.49	5.49
Heating 2.24 RSc ..	18.6	63463	22.4	76428	3.42	1.37	2.16	76.2	11.95	4.8	0.88	31.20	1.64	3.62
2.24 RSc ..	14	47597	16.8	57321	2.62	1.05	1.65	58.21	6.98	2.8	0.67	23.63	1.24	2.72
2.24 RSc ..	9.3	31731	11.2	38214	1.0	0.4	1.08	38.09	3.2	1.3	0.45	16.08	0.85	1.81

NB - Burner pressures are approximate and gas rate should be checked on the meter

Boiler dimensions -

2.24 RSc - Height 821 mm (32.5") x Width 481 mm (19") x Depth 366 mm (14.5")
Clearances - Top 300 mm (12") Sides 150 mm (6") Bottom 150 mm (6")

Hot water	Flow rate - raised 50° C (90° F)	2.24 RSc 8 l/min 1.75 gpm	Weight 2.24 RSc 50 kg (110 lbs)																								
	30° C (54° F)	13.3 l/min 2.93 gpm																									
	Minimum water pressure	1 bar	Water content																								
	Maximum water pressure	7 bar																									
Boiler	Maximum head	3.5 bar	<table border="0"> <tr> <td></td> <td>Natural Gas</td> <td>Propane</td> </tr> <tr> <td></td> <td>2.24 RSc</td> <td>2.24 RSc</td> </tr> <tr> <td>Flue size</td> <td>125 mm (5")</td> <td>Manifold injectors x 18</td> </tr> <tr> <td></td> <td></td> <td>Pilot injector</td> </tr> <tr> <td></td> <td></td> <td>Restrictor</td> </tr> <tr> <td>Connections</td> <td></td> <td>Maximum temps</td> </tr> <tr> <td></td> <td></td> <td>Hot water : 60° C</td> </tr> <tr> <td></td> <td></td> <td>Central heating : 90° C</td> </tr> </table>		Natural Gas	Propane		2.24 RSc	2.24 RSc	Flue size	125 mm (5")	Manifold injectors x 18			Pilot injector			Restrictor	Connections		Maximum temps			Hot water : 60° C			Central heating : 90° C
	Natural Gas	Propane																									
	2.24 RSc	2.24 RSc																									
Flue size	125 mm (5")	Manifold injectors x 18																									
		Pilot injector																									
		Restrictor																									
Connections		Maximum temps																									
		Hot water : 60° C																									
		Central heating : 90° C																									

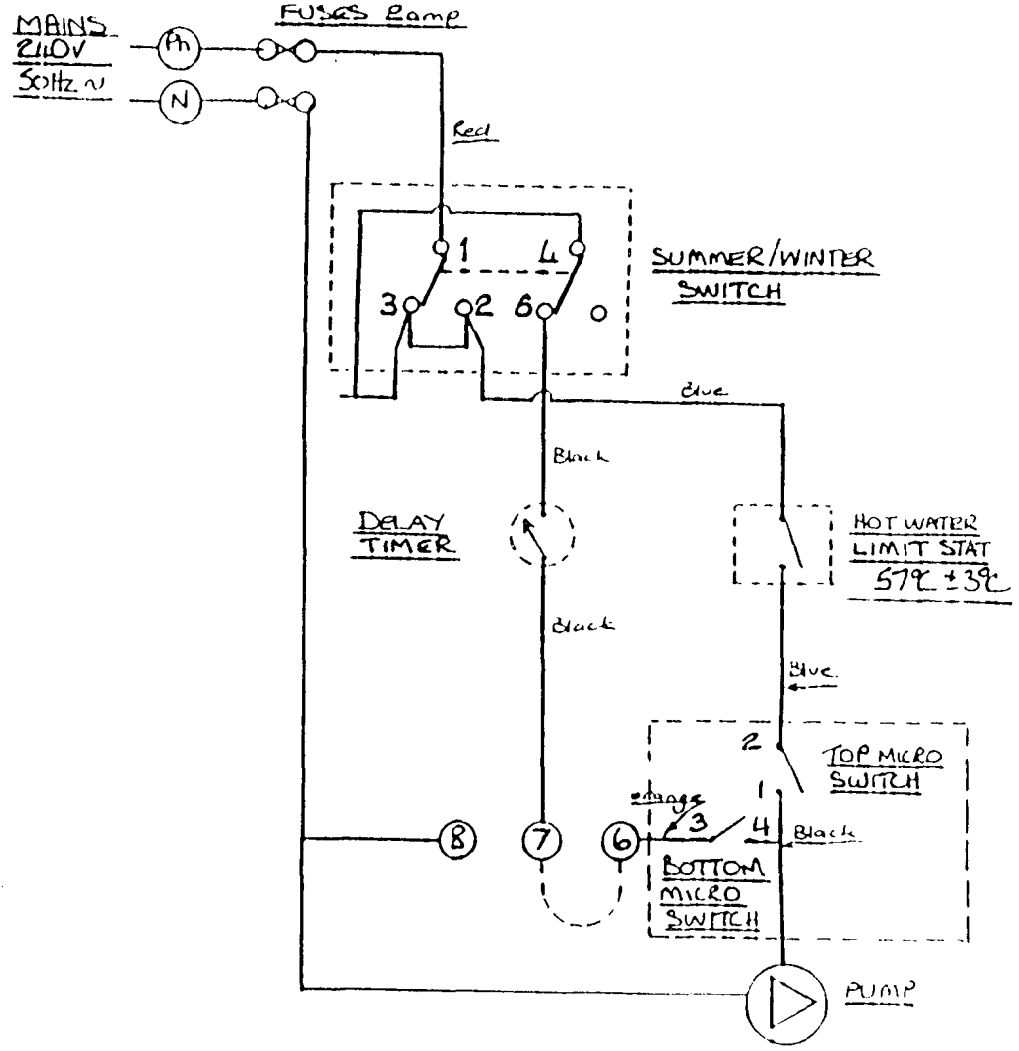
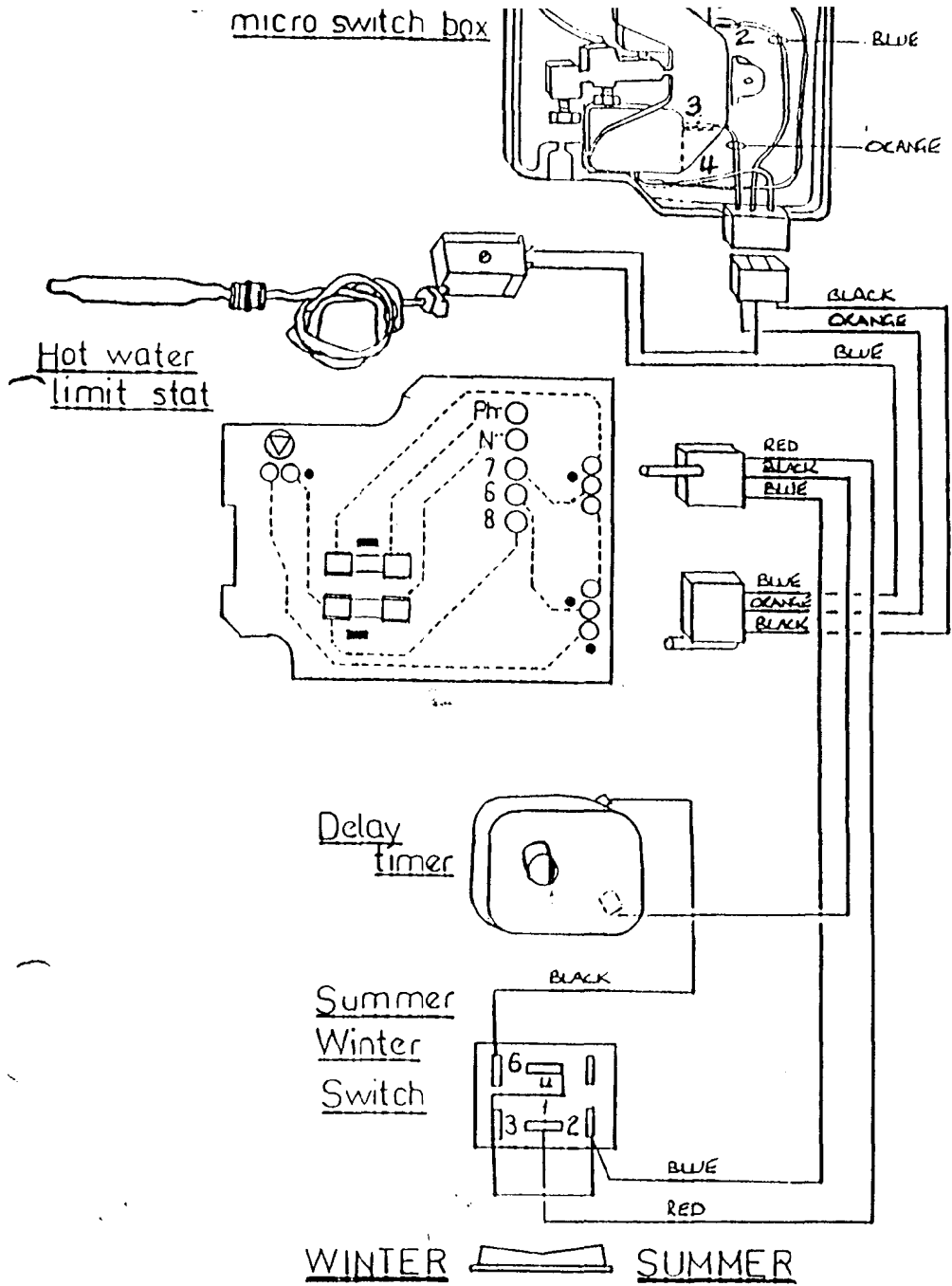

224

<u>FAULT</u>	<u>POSSIBLE CAUSE</u>	<u>REMEDY</u>
BURNER WILL NOT LIGHT AND PUMP NOT RUNNING ON HOT WATER DEMAND	- SUMMER AND WINTER SWITCH NOT TURNED ON	SWITCH ON
	- CHECK HOT WATER CIRCUITS	PURGE THE CIRCUITS
	- OPEN THE WATER SERVICE TAP	OPEN
	- OPEN HOT TAPS	OPEN
	- HOT WATER FILTER BLOCKED	REMOVE AND CLEAN
	- WATER REGULATOR STICKING	CLEAN.
	- NON-RETURN VALVE STICKING IN HOT WATER SECTION.	REMOVE AND FREE
	- DIAPHRAGM SPLIT OR DAMAGED IN HOT WATER SECTION.	REMOVE AND REPLACE
	- TOP MICROSWITCH NOT MADE ABOVE DIVERTER VALVE	ADJUST OR REPLACE
	- HOT WATER THERMOSTAT FAULTY OR OUT OF CALIBRATION.	REPLACE OR ADJUST
- PLUG IN SOCKETS	CHECK CONNECTOR PINS AND SNAP HOME.	
BURNER WILL NOT LIGHT AND PUMP NOT RUNNING ON HEATING DEMAND	- SUMMER AND WINTER SWITCH NOT TURNED ON	SWITCH ON TO HEATING
	- DELAY TIMER	SWITCH TO STOP BY PASS OR REPLACE.
	- AUXILARY CONTROL INCORRECTLY WIRED - IF FITTED	LOOP ACROSS TERMINALS 6 & 7
	- BOTTOM MICRO - SWITCH NOT MAKING ON DIVERTER VALVE	ADJUST OR REPLACE
	- PLUG IN SOCKETS	CHECK CONNECTOR PINS AND SNAP HOME
	- RETURN AND FLOW ISOLATING VALVES CLOSED	OPEN
	- FILTER BLOCKED ON HEATING RETURN	REMOVE AND CLEAN
	- NO WATER IN HEATING CIRCUITS	FILL AND PURGE
	- PRESSURE GAUGE NOT REGISTERING 1.5 BAR.	RE-PRESSURISE
	- RETURN	
COMPLAINTS OF NOISE	- OVER-GASSED	CHECK RATE AND ADJUST
	- SLUDGE OR SCALE IN HEAT EXCHANGER	DESCALE OR REPLACE
	- THERMOSTAT CARTRIDGE FAULTY	CHECK FLOW TEMPERATURES AND REPLACE
	- RETURN WATER FILTER BLOCKED.	CLEAN
	- WATER SECTION PUSH ROD STICKING.	CLEAN AND RE-GREASE

FAULT FINDING CHART

Re - CELTIC DUAL PURPOSE BOILER 224.

<u>FAULT</u>	<u>POSSIBLE CAUSE</u>	<u>REMEDY</u>
PILOT WILL NOT LIGHT	- GAS SUPPLY NOT TURNED ON	TURN ON
	- GAS SUPPLY PIPES NOT PURGED OF AIR	PURGE
	- BLOCKED PILOT INJECTOR	CLEAN OR REPLACE
PILOT GOES OUT WHEN GAS KNOB IS RELEASED	- GAS CONTROL KNOB NOT FULLY HELD IN BEFORE RELEASING	PRESS IN FIRMLY BEFORE RELEASING
	- THERMOCOUPLE NOT IN TIP OF PILOT FLAME	ADJUST
	- FAULTY THERMOCOUPLE OR UNION LOOSE	REPLACE OR TIGHTEN
	- FAULTY THERMO-ELECTRIC VALVE	REPLACE
	- MAIN GAS VALVE NOT PURGED	REPEAT IGNITION SEQUENCE
	- STEMCO OVERHEAT FAILING	REPLACE
	- LOOSE SPADE CONNECTION ON STEMCO	TIGHTEN
	- PILOT FLAME TOO SOFT	TIGHTEN PILOT INJECTOR SECURING NUT
PUMP NOT RUNNING	- ELECTRICITY NOT SWITCHED ON - FUSES BLOWN	CHECK SUPPLY AND FUSES
	- SUMMER/WINTER SWITCH NOT TURNED ON	TURN ON
	- AUXILIARY CONTROL INCORRECTLY WIRED - IF FITTED	LOOP OUT CONTROLS AT BOILER TERMINALS 6 & 7.
	- PUMP JAMMED	TURN ROTOR WITH SCREWDRIVER TO FREE
	- BOTTOM MICROSWITCH NOT MAKING ABOVE DIVERTOR VALVE.	ADJUST OR REPLACE
	- CHECK HOT WATER CIRCUITS AND RE-FILLING OF THE HEATING CIRCUITS	REFER TO INSTALLATION INSTRUCTIONS - PAGE 8.
BURNER WILL NOT LIGHT WITH PUMP RUNNING	- FILTER BLOCKED ON HEATING RETURN.	REMOVE AND CLEAN
	- FILTER BLOCKED AT PUMP CONNECTING SMALL CAPILLARY TUBE TO BOTTOM OF WATER SECTION	REMOVE AND CLEAN
	- AIR LOCK IN PUMP	VENT
	- AIR SEPARATOR SCREW CAP NOT OPENED.	OPEN
	- WATER SECTION JAMMED	CLEAN - RE-GREASE
	- GAS VALVE SPINDLE JAMMED	CLEAN - RE-GREASE
	- DIAPHRAGM SPLIT OR DAMAGED	REPLACE
	- PUMP RUNNING AT SLOW SPEED FAULTY CONDENSOR OR PUMP.	EXCHANGE

CONT'D...

CELTIC 2.24

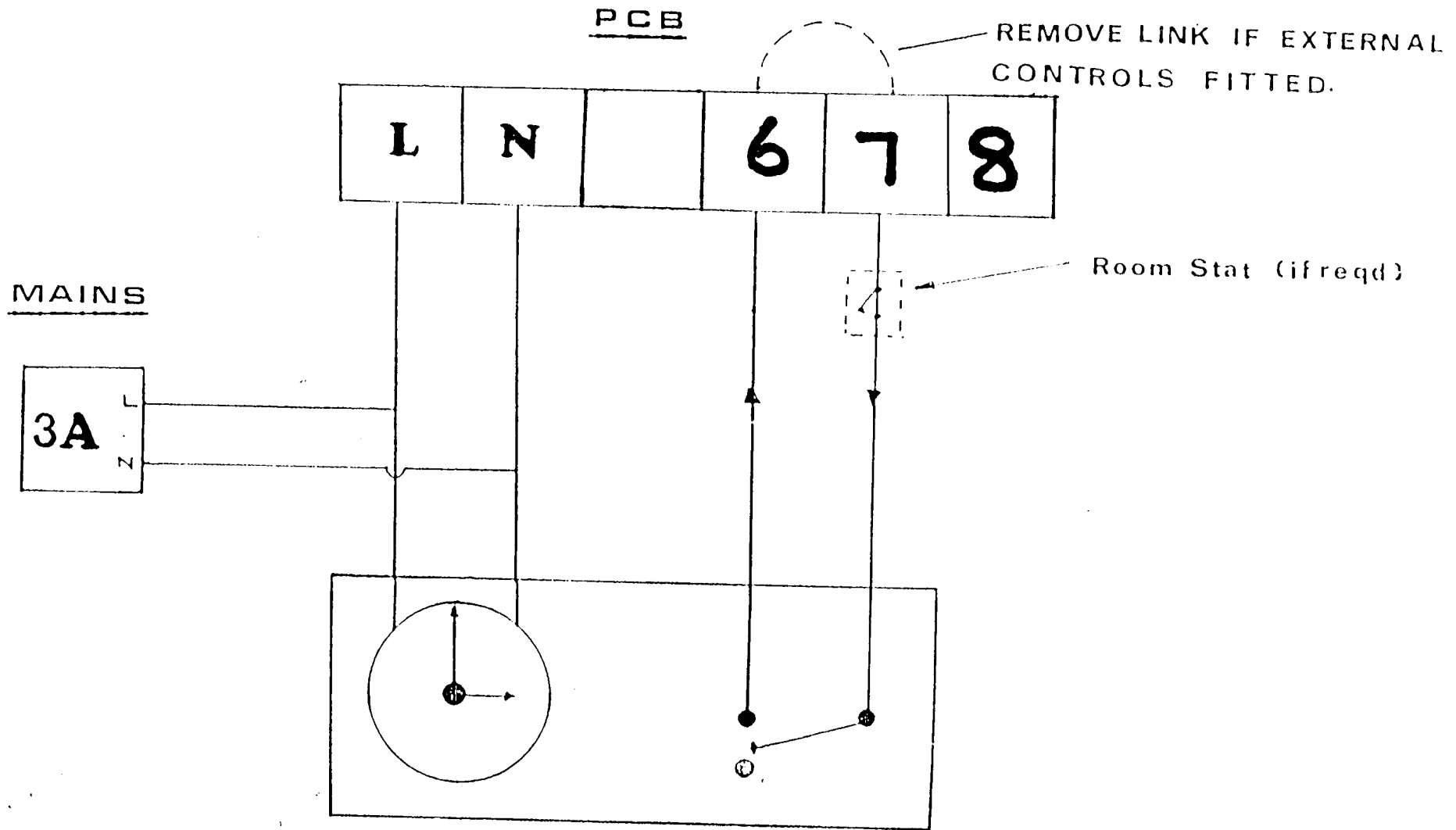

TIME CLOCK — VOLTAGE FREE SWITCHING.

