

Calydra

COMBINATION BOILER

Heating and Instantaneous Domestic Hot
Water with TSS®

Fanned Flue system

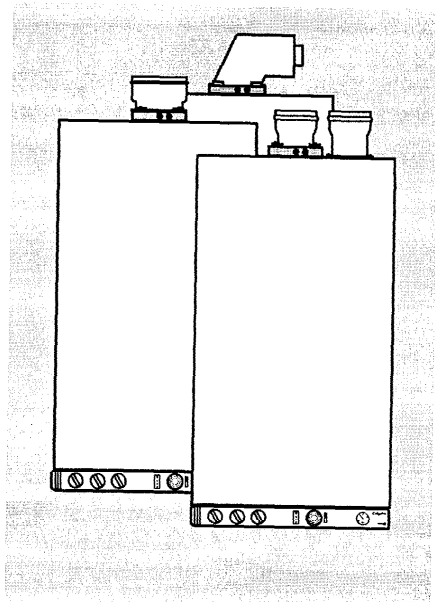

Calydra 80

Calydra 100

Installation and Operating instructions

Chaffoteaux
et Maury



These instructions are suitable for the following boilers :

Calydra 80

Calydra 100

CUSTOMER CARE

Chaffoteaux et Maury Ltd., as a leading manufacturer of domestic and commercial water heating appliances, as well as domestic unvented direct and indirect storage cylinders, is committed to providing high quality products and a first class after sales service. If it is necessary to contact an engineer, then telephone your local Chaffoteaux Service Centre. The number can be obtained from the leaflet enclosed with your appliance or by telephoning the Chaffoteaux Customer Services Department at Telford.

Advice on installation or servicing can also be obtained by contacting the Chaffoteaux Customer Services Department.

CUSTOMER SERVICES DEPARTMENT

Tel: 01952 222288

Fax: 01952 260915

GUARANTEE

The manufacturer's guarantee against faulty manufacture or materials for the cylinder and secondary heat exchanger is 5 years, from the date of purchase. For the boiler, electrical components, thermal controls and safety valves it is 12 months, from the date of purchase.

The guarantee will be invalidated if the factory fitted DHW pressure relief valve is tampered with or removed. The Manufacturer or Distributors cannot be held responsible for any damage howsoever caused and which is a consequence of the removal or tampering.

The guarantee may also be invalidated if the appliance is not installed by a competent person in accordance with the recommendations made herein, current standards, regulations or in a manner not approved by the manufacturer, modified in any way, subjected to frost, misuse or neglect and that factory fitted parts have had unauthorised repairs or replacements carried out. Evidence of purchase and the date of supply must be made available at the time of any claim. The guarantee is only valid for appliances installed in the UK.

To assist us in providing you with an efficient after sales service, please return the guarantee registration card enclosed with the cylinder without delay.

STATUTORY REQUIREMENTS

The installation of this appliance must be carried out by a CORGI Registered person or other competent person and in accordance with the requirements of the Gas Safety (Installation and Use) Regulations.

In addition, the installation must also comply with the current byelaws of Local Water Undertakings, Building Regulations, IEE Wiring Regulations, Local Authority Building Standards (Scotland) Regulations and the Safety Document 635 The Electricity at work Regulation.

It should also be carried out in accordance with current editions of the following British Standards Codes of practice: BS 6891, BS 5440 parts 1 and 2, BS 5449 part 1, BS 7593, BS 6798, BS 5546, BS 4814, BS 7074 part 1 and 2, BS 7671 and BG DM2.

If there is a possibility of the incoming mains water pressure exceeding 7 bar then a suitable pressure limiting valve must be fitted.

Precautions: During servicing, keep the dust generation to a minimum and avoid inhaling any dust and contact with the skin and eyes. Normal handling and use will not present any discomfort, although some people with a history of skin complaints may be susceptible to irritation. When disposing of the lining, ensure that it is securely wrapped and wash hands after contact.

CALYDRA INSTALLATION MANUAL

Contents

	Page		Page
CUSTOMER CARE	3	LIGHTING THE BOILER	22
Guarantee	3	POST COMMISSIONING	23
Statutory Requirements.....	3	HANDING OVER TO THE HOUSEHOLDER	23
Contents.....	4	SYSTEM GUIDANCE	24
INTRODUCTION	5	FLUE	24
DESCRIPTION	6	VENTILATION	25
LOCATION OF COMPONENTS	6	GAS SUPPLY	25
SPECIFICATIONS	8	ELECTRICAL SUPPLY	25
DIMENSIONS	10	FLUSHING AND WATER TREATMENT	26
OPERATION	12	SYSTEM CONTROLS	26
DOMESTIC HOT WATER MODE	12	BY PASS AND PUMP	27
CENTRAL HEATING MODE	14	EXPANSION VESSEL	28
INSTALLATION	15	FILLING POINT	28
PLANNING	15	MAINTENANCE	28
LOCATION	15	USER'S INSTRUCTIONS	29
INSTALLING THE CALYDRA	15	Control panel.....	29
INSTALLATION	15	Isolating Taps.....	29
POSITIONING THE BOILER ON THE WALL	15	SWITCHING ON	30
CONNECTING THE BOILER TO THE SYSTEM	16	Hot Water.....	30
FITTING THE HORIZONTAL FLUE	17	Heating and Hot Water.....	30
MAKING THE ELECTRICAL CONNECTIONS	18	Heating Only.....	30
PRE-COMMISSIONING	20	To Turn Boiler Off Completely.....	30
Electrical Adjustments	20	INSTRUCTIONS FOR SETTING THE BUILT IN CLOCK	31
1. Room thermostat options.....	20	MECHANICAL TIMER	31
2. Pump Speed Adjustment.....	20	1. General Layout.....	31
3. Burner operating modes.....	20	2. To Set the Time.....	31
COMMISSIONING	22	3. To Set the "On" and "Off" Times.....	31
DHW	22	4. To Select Function MODE.....	31
Central Heating	22		

Introduction

By combining their modern highly efficient low water content fanned flue combination boiler concept and the brand new TSS® "Temperature Stabilised System", Chaffoteaux et Maury have created a whole new concept.

CALYDRA

This unique combination is able to provide the user with hot water immediately at the outlet of the appliance and stable temperatures at both extremely low flow rates or when several taps are opened together.

The TSS® is a 5 litres, independently controlled mini unvented storage cylinder, powered by a 3 kW coil. It works in conjunction with the Chaffoteaux et Maury low pressure instantaneous domestic hot water system.

The CALYDRA, as well as providing hot water, provides central heating. The boiler is designed for sealed systems only. A two speed circulating pump, diverter valve, expansion vessel as well as a pressure gauge and safety valve are included within the boiler.

The CALYDRA provides the advantages of mains pressure hot water to taps and showers. Supplied directly from the main water supply the CALYDRA does not need a separate feed cistern or vent pipe in the loft space.

The CALYDRA has been tested and approved by the WRc as meeting with the requirements of the water by-laws scheme. The boiler has been tested and approved to carry the CE mark.

The CALYDRA can be installed with the standard horizontal flue, raised horizontal, concentric vertical, twin pipe flue or seduct arrangements. Adapters, bends and other accessories are available on request.

The boiler is packed in TWO cartons:

1. The boiler.
2. The flue assembly and fixing kit.

Description

Location of components

1. Flue hood with fan
2. Sealed chamber
3. Gas valve assembly
4. Electrical box
5. Pump
6. Automatic air separator and automatic vent
7. Multi-gas burner assembly comprising ignition and ionisation electrodes
8. Combustion chamber
9. Main heat exchanger
10. Steel chassis complete with expansion vessel
11. Air pressure switch
12. Overheat thermostat
13. TSS® (mini cylinder)
14. Central heating control thermistor
15. Three way valve
16. Expansion vessel connecting tube
17. By pass adjustment screw
18. By pass
19. CH Flow isolating valve
20. Domestic hot water outlet
21. Gas service tap
22. Water service tap
23. CH Return isolating valve
25. Pressure relief valve
27. DHW pressure relief valve
28. TSS® control thermistor

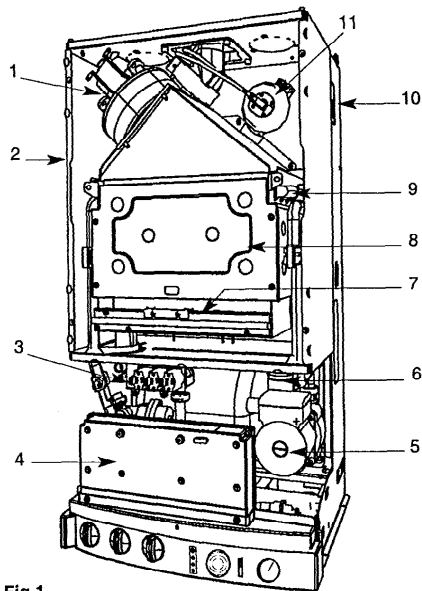

Fig.1

Description (continued)

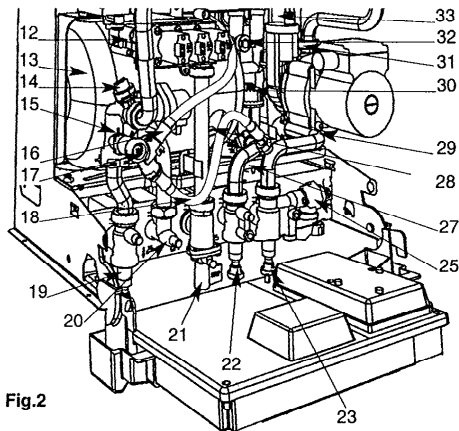

Fig.2

- 29. Location of heating filter (not visible)
- 30. DHW circuit flow switch
- 31. Heating circuit flow switch
- 32. Hot water control thermistor
- 33. Secondary heat exchanger
- 34. Four position selector switch
- 35. User's instruction panel
- 36. Domestic hot water temperature adjustment

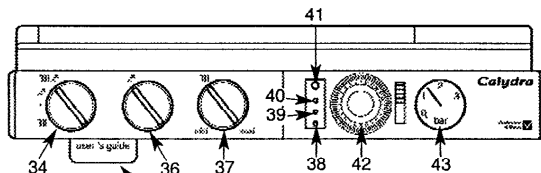
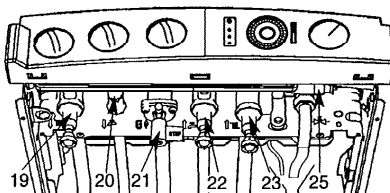

Fig. 3



- 37. Heating flow temperature adjustment
- 38. Green indicator - Power ON
- 39. Orange indicator - Burner ON
- 40. Red indicator - Lock out / flame failure
- 41. Reset button
- 42. Mechanical clock
- 43. Pressure gauge

Description (continued)

SPECIFICATIONS

	80	100	CALYDRA	80	100
CALYDRA					
Appliance category	Cat II 2H 3+	Cat II 2H 3+	Natural gas G20		
Heat input C/H & DHW			Gas rate		
Maximum	25.9 kW 88392 Btu/h	31.1 kW 106138 Btu/h	Maximum	2.74 m ³ /h 97 ft ³ /h	3.29 m ³ /h 116 ft ³ /h
Heat output C/H & DHW			Inlet pressure		
Maximum	23.25 kW 79347 Btu/h	28.0 kW 95558 Btu/h	Nominal	20 mbar 8 in wg	20 mbar 8 in wg
C/H circuit pressures			Burner pressure		
Min operating	0.7 bar 10 lb/in ²	0.7 bar 10 lb/in ²	Nominal	11 mbar 4.4 in wg	12.8 mbar 5.12 in wg
Max operating	2.5 bar 36.3 lb/in ²	2.5 bar 36.3 lb/in ²	Burner injector and restrictor diameter		
DHW specific flow rates for 10 min @ 30 deg C rise	11.5 l/min 2.54 gal/min	13.9 l/min 3.06 gal/min	Natural gas G20	1.23 mm 2.60 mm	1.28 mm 2.9 mm
@ 35 deg C rise	9.86 l/min 2.17 gal/min	11.91 l/min 2.62 gal/min	1/3 restrictor	6.7 mm	no restrictor required
DHW circuit pressures			2/3 restrictor		
Min operating	0.1 bar 1.45 lb/in ²	0.1 bar 1.45 lb/in ²	PROPANE LPG G31		
Max operating	7 bar 100 lb/in ²	7 bar 100 lb/in ²	Gas rate	2.00 kg/h 4.41 lb/hr	2.42 kg/h 5.34 lb/hr
Flow limiter rate	8 l/min	10 l/min	Maximum		
Compartment ventilation	not required		Inlet pressure	37 mbar 14.8 in wg	37 mbar 14.8 in wg
			Nominal		
			Burner pressure	35 mbar 14 in wg	30.4 mbar 12.16 in wg
			Nominal		

Description (continued)

CALYDRA	80	100	CALYDRA	80	100
BUTANE LPG G30			Safety discharge - Heating	2.5 bar	2.5 bar
Gas rate				36.25 lb/in2	36.25 lb/in2
Maximum	2.04 kg/h	2.45 kg/h	Safety discharge - DHW		
	4.50 lb/h	5.40 lb/h		7 bar	7 bar
Inlet pressure				100 lb/in2	100 lb/in2
Nominal	28 mbar	28 mbar	Expansion vessel		
11.2 in wg	11.2 in wg		Pre-charge pressure	0.7 bar	0.7 bar
Burner pressure				9.4 lb/in2	9.4 lb/in2
Nominal	26.7 mbar	24 mbar	Net capacity at 2.5 bar	5.44 ltr	5.44 ltr
	10.7 in wg	9.6 in wg	Adjustable by-pass		
Burner injector and restrictor diameter			Minimum flow rate	150 l/h	150 l/h
Butane LPG G30	0.7 mm	0.76 mm		0.55 gal/min	0.55 gal/min
1/3 restrictor	1.75 mm	2.0 mm	Maximum flow rate	480 l/h	480 l/h
2/3 restrictor	4.9 mm	6.7 mm		1.76 gal/min	1.76 gal/min
			Electrical characteristics		
			Supply	230 v 50 Hz	230 v 50 Hz
			Consumption	155 W	155 W
			Protection	IP 44	IP 44
			Fuse no 1	2 A	2 A
			Fuse no 2	1.25 A	1.25 A
			External controls	24 V	24 V

Dimensions

Weights

With packaging :

-Calydra 80 :	49.0 kg
-Calydra 100 :	49.5 kg

Without packaging :

-Calydra 80 :	46.5 kg
-Calydra 100 :	47.0 kg

Lift weight :

-Calydra 80 :	41.5 kg
-Calydra 100 :	41.0 kg

Tails diameter

J	Heating flow	Ø 22 mm
K	D.H.W. flow	Ø 15 mm
L	Gas supply	Ø 22 mm
M	Cold water inlet	Ø 15 mm
N	Heating return	Ø 22 mm
P	Safety valve outlet	Ø 15 mm

Outer case dimensions :

- Width :	440 (minimum space required 450)
- Height :	850
- Depth :	380

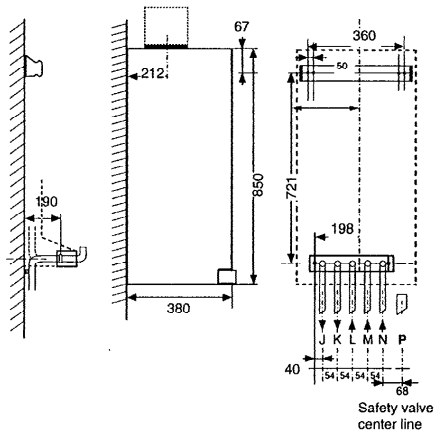

All dimensions in mm

Fig. 4

Dimensions (continued)

Minimum clearances :

- Both sides 5 mm
- Above casing 170 mm
- Below casing 200 mm
- Front (for servicing) 500 mm
- Front (in operation) 5 mm

The Calydra 80 and 100 are suitable for the 3 flue types :

- type C 12 or C 42
- type C 22
- type C 32 xx or C 32 xy

TYPE C12, C42 or C22

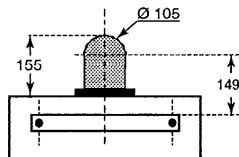

TYPE C32 xx

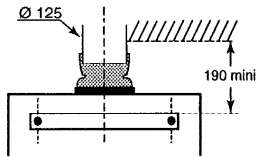

TYPE C32 xy

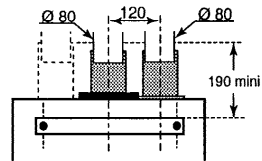





Fig. 5 Dimensions in mm



Operation

Domestic Hot Water Mode

To be able to supply hot water, the selector switch (34 fig. 6) must be in either on  or  position. This will be confirmed by the green indicator light  (38 fig. 6).

The hot water temperature in the mini cylinder can be adjusted between 40°C and 60°C using control knob (36 fig. 6).

When a tap or shower is turned on and the flow of mains water is above 2 litres per min., it will activate the DHW flow switch 30 fig. 7 and allow the 3 way valve (15 fig. 7) to move to the DHW position. The pump can now circulate primary water heated by the main heat exchanger through the secondary heat exchanger.

The safety solenoid (3a fig. 7) and the first stage solenoid (3b fig. 7) open together to allow gas to the burner. The ignition sequence begins and a continuous high speed spark ignites the gas. As soon as a flame is detected the orange indicator bulb  (39 fig. 6) will light and the second stage solenoid (3c fig. 7) opens to allow the full gas rate. If a flame is not detected, after 8 seconds, the safety solenoid and the first stage solenoids close and shut off the gas. The red lockout indicator bulb  (40 fig. 6) will light.

Over 2 l/min, the domestic hot water temperature is controlled by the hot water control thermistor (32 fig. 7) and the heating control thermistor (14 fig. 7), but

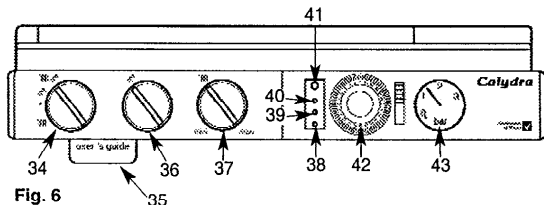

Fig. 6

dependant upon to the position of the DHW temperature adjustment knob (36 fig. 6). This system anticipates the changes of temperature in the secondary heat exchanger and ensures accurate temperature regulation.

When the tap is closed the burner is extinguished and the pump runs on for 10 seconds (unless the mini cylinder thermistor is calling for heat, in which case the burner will remain on at a low rate and the pump will continue running until the mini cylinder thermistor is satisfied). The boiler will now stay in the hot water mode for 30 seconds to be ready for a subsequent draw off (this can be set to 3 minutes if required. See Maintenance and Service Guide).

Priority is given to a demand for hot water. This will interrupt the central heating for the duration of hot water delivery or recovery of the mini cylinder.

When the boiler has been in standby in Hot Water Mode for some time or when drawing DHW at flow rates of less than 2 l/min the temperature in the mini cylinder will eventually decrease and the

Operation (continued)

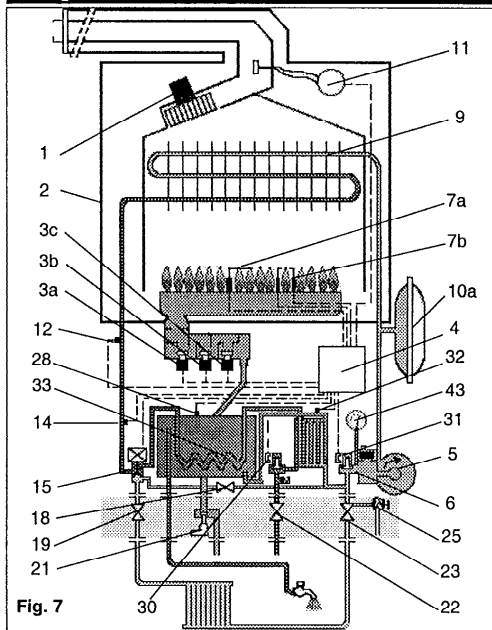

TSS[®] control thermistor will call for heat. Bringing the pump and burners to operate, this is quite normal.

The 3 way valve (15 fig. 7) will move to the domestic hot water position. The hot water from the primary circuit is then diverted to heat the mini cylinder via the coil and the secondary heat exchanger.

The safety solenoid (3a fig. 7) and the first stage solenoid (3b fig. 7) open together to allow a low rate of gas to the burner.

The ignition sequence begins and a continuous high speed spark ignites the gas. As soon as a flame is detected the orange indicator bulb (39 fig. 6) will light and the burner will remain on low rate until the TSS[®] control thermistor (28 fig. 7) is satisfied. If a flame is not detected, after 8 seconds, the security and first stage solenoids close and shut off the gas.

The red lockout indicator bulb (40 fig. 6) will light.

The hot water flow temperature is controlled by the primary circuit control thermistor (14 fig. 7).

When the cylinder thermistor is satisfied, the burner is extinguished and the pump remains running for 10 seconds at low speed.

The boiler will now stay in the hot water mode for 30 sec. (this can be set to 3 minutes if required. See Maintenance and Service Guide).

Priority is given to a demand for hot water or reheating the mini cylinder.

Operation (continued)

Central Heating Mode

To be able to supply heating, the selector switch (34 fig. 6) must be in "III 🔥" (heating and hot water position) or "IIII" (heating only position). This will be confirmed by the green indicator light ○ (38 fig. 6).

When there is a demand for heating (either from a room thermostat, the built-in clock or an external programmer) and the boiler temperature control is calling for heat.

The pump starts and at a flow rate of 4 ltr/min the central heating flow switch operates allowing the ignition sequence to begin.

The safety solenoid (3a fig. 7) and the first stage solenoid (3b fig. 7) open together to allow gas to the burner.

The ignition sequence begins and a continuous high speed spark ignites the gas.

As soon as a flame is detected the orange indicator bulb 🔦 (39 fig. 6) will light.

After 45 seconds the second stage solenoid (3c fig. 7) opens to allow the full gas rate.

If a flame is not detected, after 8 seconds, the security solenoid closes and shuts off the gas.

The red lockout indicator bulb 🔦 (40 fig. 6) will light.

The central heating flow temperature is controlled by the heating control thermistor (14 fig. 7).

The boiler has been designed to minimise cycling and will not attempt to relight for at least 3 minutes after the heating control thermistor has been satisfied (this can be set to 30 seconds if required. See Maintenance and Service Guide).

When the built-in clock, room thermostat and external programmer are satisfied, the burner will switch off and the pump will remain running for a further 3 minutes. (this can also be set to 30 seconds if required. See Maintenance and Service Guide).

NB It is possible to override the 3 minute delay by pressing the RESET button (41 fig. 6).

Installing the boiler

Planning

Please ensure that you are familiar with the installation requirements as well as the relevant British Standards and Statutory Regulations (see page 3) before commencing work.

Location

The CALYDRA can be installed on any suitable internal wall. Provision must be made to allow the correct routing of the flue and siting of the terminal to allow the safe and efficient removal of the flue products. The appliance may be installed in any room, although reference must be made to the IEE regulations if it contains a bath or shower. A compartment or cupboard may be used provided that it has been purpose-built or modified for the purpose. It is not necessary to provide permanent ventilation for cooling purposes. Detailed recommendations are given in BS 5440 pt 2. If it is proposed that it is installed in a timber framed building then reference must be made to British Gas Document DM2, or advice sought from CORGI.

INSTALLING THE CALYDRA

Installation

The installation kit included with the flue components comprise following items :

- Hanging bracket
- A paper template (showing the dimensions of the boiler with 5 mm side clearances and fitting instructions and on the reverse, the fixing positions for the spacer bracket)
- Connection tails
- Screws and wall plugs
- Connection washers
- Pre-piping jig
- Installation and Operation manual

Positioning the boiler on the wall.

The paper template can be used to ensure the correct positioning of kitchen cabinets etc.

The paper template is fixed to the wall and used to locate the position of the hanging bracket, the centre for the flue hole and, if required, the fixings for the pre-piping jig.

If there is a requirement to pass the piping behind the boiler, it will be necessary to fit a spacing bracket. This is available as an optional accessory. The standard paper template shows the positions for the spacing bracket fixing screws.

Installing the boiler (continued)

Drill and plug the wall and secure the hanging bracket using the screws provided (refer to the paper template drawings). Remove the boiler from its packaging as shown in (fig. 8) and remove the outer case as shown in (fig. 9).

Please note: If the pre-piping jig has been used it must be removed before attempting to hang the boiler.

Place the boiler on the wall on the hanging bracket.

Connecting the boiler to the system

- Push in the tabs P (fig 10) on either side of the boiler and pivot the electrical box forward to gain access to the valve connections.
- Remove the yellow caps and connect the boiler to the taps using washers provided in the plastic bag.

3 x fibre washers for the C/H flow and return and hot water outlet connections

1 x fibre washer and mesh filter "F" for the cold water inlet.

1 x rubber washer "R" for gas connection.

Using (fig. 10) for reference, connect the gas and water pipes to the valves located at the base of the appliance using the tails provided. There is a 190 mm space between the valves and the wall to make these connections.

Provision must be made to fill and recharge the system pressure. This can be achieved using a filling loop or other methods approved by the local water authority.

Safety Valves

There are two pressure relief valves fitted to the CALYDRA. The DHW pressure relief valve connecting pipe is supplied attached to the valve and the CH pressure relief valve tube is clear silicone and is packed with the boiler. They should terminate together below the boiler over a tundish or a 28 mm to 22 mm reducer (see P 17, fig 10) which should in turn discharge safely outside the premises. Care should be taken

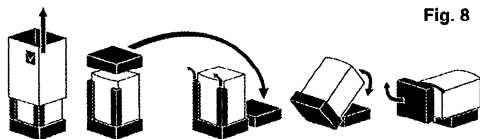

Fig. 8

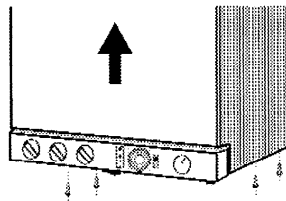

Fig. 9

Installing the boiler (continued)

so that it does not terminate over an entrance or window or where a discharge of heated water could endanger occupants or passers by.

The system should be carefully checked for leaks, as frequent refilling could cause premature system corrosion or unnecessary scaling of the heat exchanger.

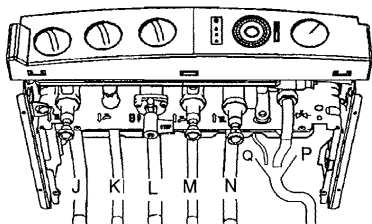

Fig. 10

J	Heating flow	Ø 22 mm
K	D.H.W. flow	Ø 15 mm
L	Gas supply	Ø 22 mm
M	Cold water inlet	Ø 15 mm
N	Heating return	Ø 22 mm
P	Safety valve outlet	Ø 15 mm
Q	D.H.W. safety valve outlet	Ø 15 mm

Fitting the Horizontal Flue

The instructions for the installation of the elevated horizontal, concentric vertical, biflux (twin pipe) and SE duct flue options are included with the relevant adapter kits.

The horizontal standard flue supplied with the appliance is suitable for lengths from 300 mm minimum to 610 mm maximum. This means for rear flueing, the standard kit will accommodate a maximum wall thickness of 490 mm, and for side flueing a maximum wall thickness of 477 mm. This takes into account the minimum appliance side clearances of 5 mm. If the fixing is a rear exit flue, the template provides the position of the centre for drilling the flue hole with a core drill. If the flue is a side exit installation then calculate the position of the hole with a slope, away from the boiler, of 5 mm / metre to the terminal.

Installing the boiler (continued)

Making the Electrical Connections

Push in the tabs (P fig. 11) on either side of the boiler and pivot the electrical box forward to gain access to the electrical connections.

Undo the two retaining screws (A fig. 11), remove cover (B fig. 11) and remove cable clamp.

Connect the live and neutral wires to the multipin plug leaving sufficient earth wire to connect to the earthing point. (B fig. 12)
Note: The connections should be made so that should the lead be pulled from its anchorage, the current carrying wires become taut before the earth wire.

If using a room thermostat or other external control, they can be connected in place of the link on the multipin plug. (fig. 12).
C Note: Use only controls designed for voltage free switching or 24V supply. Do not connect to a 230V supply.

Connect multipin plug into the socket on the pcb (D fig. 12) attached to the cover (B fig. 11). Secure the cable using the cable clamp and replace the cover.

NB Any changes to the factory settings on the pcb can be made before replacing the electrical box cover (see electrical adjustments pages 20 and 21).

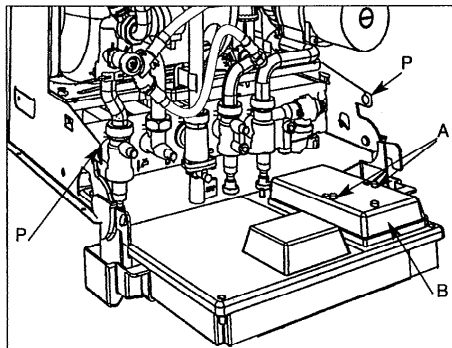

Fig. 11

Installing the boiler (continued)

Making the Electrical Connections (continued)

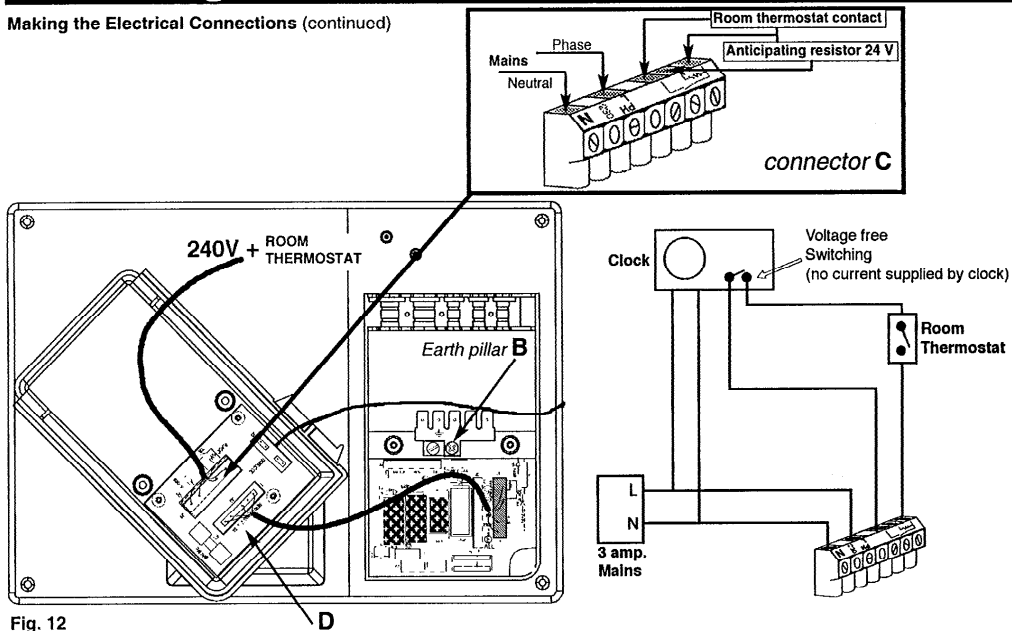

Fig. 12

Installing the boiler (continued)

Pre-commissioning

Ensure that the system has been adequately flushed.

Purge gas supply of air and test for soundness.

Carry out final electrical tests to ensure the correct polarity and earthing continuity.

Electrical Adjustments

There are three adjustments that can be made:

1. Room thermostat options
2. Pump speed
3. Burner operating modes :

1. Room thermostat options

To gain access to the setting switch (1 fig. 13) pivot forward the electrical box cover and remove the cover (B fig. 11)

- move the switch to the left - (factory setting). When room thermostat is satisfied the burner switches off and the pump over runs for 3 min.
- move switch to the right - When room thermostat is satisfied the burner switches off and the pump continues to run until the main selector is turned from a heating position.

2. Pump Speed Adjustment

- move switch to the left (marked GV) - pump on high speed (factory setting)
- move switch to the right (marked PV) - pump on low speed for use on small systems

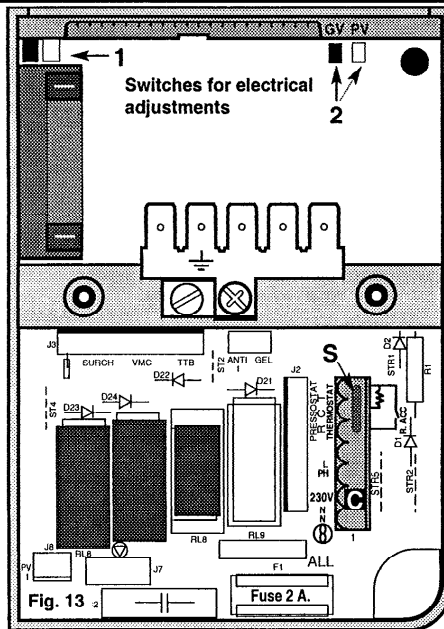

Installing the boiler (continued)

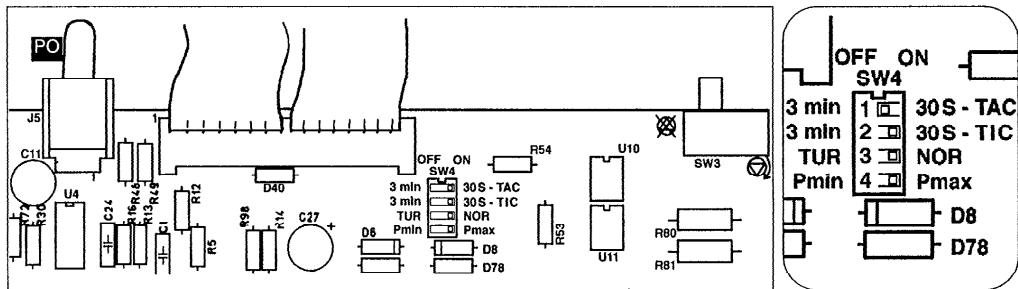

Fig. 14

factory setting

3. Burner operating modes :

To gain access to the switches it is necessary to remove the fascia:

- remove the main case
- pivot the electrical box forwards
- remove the pressure gauge clip noting its position
- replace electrical box in its upright position
- remove the two screws and unclip the fascia from the electrical box
- remove the rubber grommet to gain access to the switches

PCB adjustments (fig. 14) :

Four switches are gathered together on the regulation PCB and labeled SW4.

Switch 1 TAC selects Central heating anticycling delay

either 3 min (factory setting) or 30 sec

Switch 2 TIC selects delay switching from DHW to C/H

either 30 sec (factory setting) or 3 min

Switch 3 selects the modulation of the Burner.

NOR means normal modulation (off - 1/3 - full on) factory setting

TUR means Full On or Off mode

Switch 4 selects Central heating power limitation

Pmax means the boiler could provide full power for heating - factory setting

Pmin means power for heating is limited to 1/3 only

When settings have been made replace the rubber grommet and refit all components in the reverse order.

Commissioning

DHW

- Open the main cold feed valve.
- Open all hot taps to purge DHW system.
- Check for water soundness.

Central Heating

- Open flow and return valves on the boiler.(19 and 23 fig. 15)
- Open the automatic air vent (6 fig. 16)
- Fill system and vent radiators.
- Set system pressure and remove filling loop.
- Check for leaks.
- Manually check pump is free to turn.
- Switch on electrical supply.
- Turn selector switch (34 fig. 16) to heating only or heating and hot water position.
- Allow pump to run for several minutes.
- Isolate electrical supply.
- Drain boiler and check water filter (29 fig. 2) for installation debris.
- Replace filter and recharge system.

Lighting the Boiler

- Connect gas pressure gauge to test point (45 fig. 16).
- Turn on the gas supply and boiler gas tap (21 fig. 15).
- Ensure electrical supply is on.
- Ensure all external controls and built clock are calling for heat.
- Turn selector switch (34 fig. 16) to heating only position.

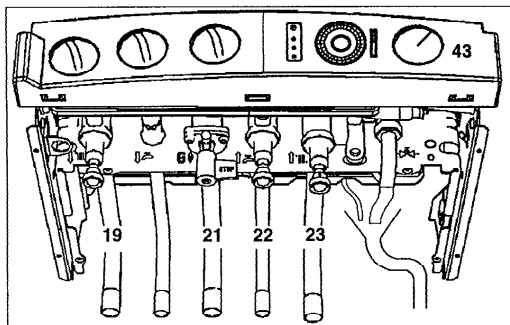

Fig. 15

- Turn the heating flow temperature adjustment to maximum (37 fig. 16).
- The boiler will light.
- Allow the boiler to heat system.
- Check the inlet gas pressure (working pressure) while boiler operating. (Refer to technical data).
- Check the operation of the boiler controls and safety devices.(see separate servicing leaflet for details)
- Set the by pass (Refer to system guidance).
- Re-flush the system to remove any dissolved oils and fluxes.
- Recharge system pressure and introduce any water treatment as required.

Commissioning (continued)

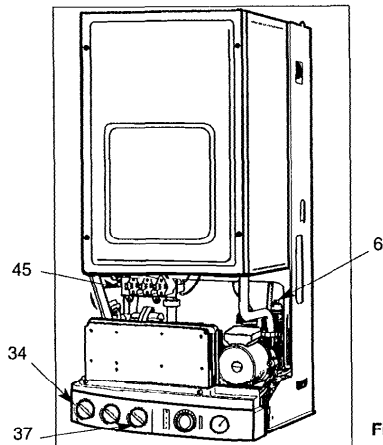

Fig. 16

Post Commissioning

- Ensure system pressure has been set correctly.
- Set DHW temperature adjustment knob to required position
- Set heating flow temperature adjustment knob to required temperature.
- Set the built in clock or external programmer to householder's requirements.
- Set external controls.
- Switch boiler to domestic hot water position and draw off hot water to allow TSS® cylinder to heat up quickly.

Handing Over to the Householder

- Demonstrate the lighting and operation of the boiler.
- Demonstrate how to maintain the system pressure.
- Demonstrate the operation and setting of the built-in clock.
- Explain that the reheating of the TSS® cylinder may bring the boiler on unexpectedly except in heating only position.
- Explain the need for annual servicing and that it must be carried out by a competent person.
- Fill out and register guarantee.
- Leave users instructions, installation manual and all other documentation with the householder.

System guidance

Flue

The boiler must be installed so that the flue terminal is exposed to the free passage of external air at all times. It must not be allowed to discharge into another room or space such as an outhouse or closed lean-to. The minimum acceptable clearances are shown below:

- A Directly below an opening, window, etc 300 mm
- B Below gutters soils pipes or drain pipes 75 mm
- C Below eaves 200mm
- D Below balconies or car port roof 200 mm
- E From a vertical drain pipe or soil pipe 75 mm
- F From an internal or external corner 300 mm
- G Above ground roof or balcony level 300 mm
- H From a surface facing the terminal 600 mm
- I From another terminal facing the terminal 1200 mm
- J From an opening into the dwelling when
under a car port 1200 mm
- K Vertically from a terminal on the same wall 1500 mm
- L Horizontally from a terminal on the same wall 300 mm
- M fixed by the flat roof ubbink rolux 4GM flue terminal
- N fixed by a pitched roof ubbink rolux 4GM flue terminal

It may be necessary to protect the terminal with a guard if it is accessible and could be damaged. Reference should be made to the Building Regulations for guidance. Suitable guards may be obtained from the following manufacturer:

Quinnel Barret & Quinnel Wireworks
Old Kent Road
London SE15 1NL
Tel: 0171 639 1357

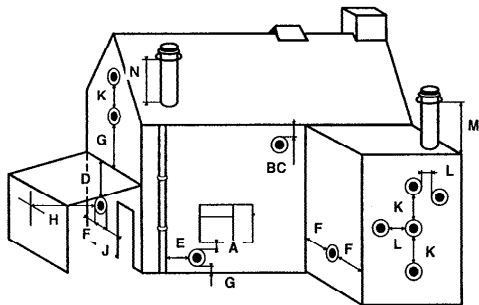

Fig. 17

System guidance (continued)

Ventilation

The room in which the boiler is installed does not require specific ventilation. **IF IT IS INSTALLED IN A CUPBOARD OR COMPARTMENT PERMANENT VENTILATION IS NOT REQUIRED FOR COOLING PURPOSES.** If vents are installed, they must communicate with the same room or be on the same wall to outside air.

Gas Supply

The gas installation and soundness testing must be in accordance with the requirements of BS 6891. The boiler requires a 22 mm supply. Ensure that the pipe size is adequate for the demand including other gas appliances on the same supply.

Electrical Supply

The appliance requires an earthed 230V - 50 Hz supply and must be in accordance with current I.E.E. It must also be possible to be able to completely isolate the appliance electrically. Connection should be via a 3 amp fused double-pole isolating switch with contact separation of at least 3 mm on both poles. Alternatively, a fused 3 Amp. 3 pin plug and unswitched socket may be used, provided it is not used in a room containing a bath or shower. It should only supply the appliance.

System Pressure

The boiler is suitable for sealed systems only. The maximum working pressure for the appliance is 3 bar. All fittings and pipework connected to the appliance should be of the same standard.

System guidance

Flushing and Water Treatment

The performance of the appliance could be impaired by system debris or the effects of corrosion. The system must be flushed thoroughly to remove metal filings, solder, machining oils and other fluxes and greases before connecting the boiler.

An appropriate flushing and descaling agent should be used, particularly if it is an existing system. Refer to BS 7593 (1992) for guidance. For more information on the use of corrosion inhibitors, flushing and descaling agents, advice can be sought from the manufacturers of water treatment products such as:

Betz Dearbon Ltd
Foundry Lane
Widnes
Cheshire
WA8 8UD
Tel: 0151 424 5351

Fernox Manufacturing
Britannica Works
Clavering
Essex
CB11 4QZ
Tel: 01799 550811

System Controls

The boiler is electrically controlled and is suitable for most modern electronic time and temperature external controls.

The addition of such controls can be beneficial to the efficient operation of the system.

The boiler connections for external controls are 24V and so only controls of 24V or that have voltage free contacts should be used.

They must not be connected to 230 V supply.

System guidance (continued)

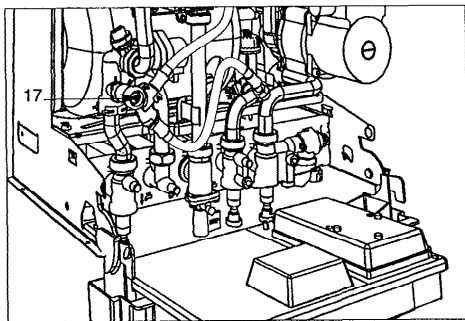
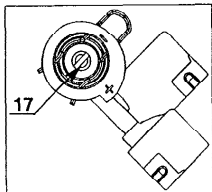
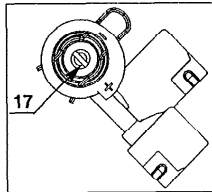

Fig. 18 detail of setting :



Cut of screw head on - :
by pass shut (factory setting)



Cut of screw head on + :
by pass open

By pass and Pump

The boiler is fitted with a pre-adjusted by pass. Although adjustment is not normally necessary, the by pass can be reset by turning screw (17 fig. 18) clockwise to open the by-pass using the chart below for guidance. It is a 1/4 turn from fully closed to fully open.

If used on a system with thermostatic radiator valves, the flow rate, through the system, with the thermostatic valves closed should be at least 100 l/hr.

The chart below indicates the residual head of the pump available for the system.

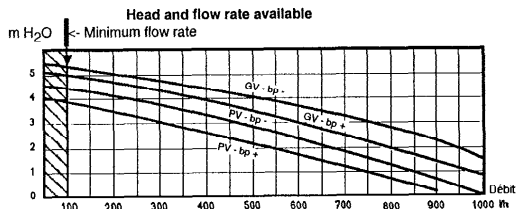

Fig. 19

“GV - bp -” means : Pump in high speed and by-pass closed

“GV - bp +” means : Pump in high speed and by-pass open

“PV - bp -” means : Pump in low speed and by-pass closed

“PV - bp +” means : Pump in low speed and by-pass open

System guidance (continued)

Expansion Vessel

The expansion vessel is pre-charged to 0.7 bar (10 lb/in²). The vessel is suitable for systems up to 145 litres capacity. For systems of greater capacity an additional expansion vessel will be required. Refer to the chart below and BS 7074 pt 1 or BS 5449.

Filling Point

Provision must be made to be able to charge the system on commissioning and to make up any subsequent pressure loss.

The method of connection must utilise approved equipment and must comply with the water regulations. A filling loop can be so installed as to be hidden beneath the boiler.

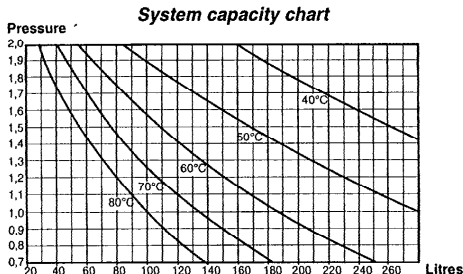

Fig. 20

MAINTENANCE

In order to ensure that the CALYDRA continues to operate efficiently and safely, it is essential that it is maintained annually. Servicing and repairs should only be carried out by a competent engineer. Any part replaced should be genuine Chaffoteaux et Maury spare parts. For details refer to the separate Maintenance and Servicing Instructions.

User's instructions

Control panel

34. Four position Selector switch

☰ = Central heating only (TSS® not operational)

● = Switched OFF

☰ = Hot water only (including TSS®)

☰ ☰ = Hot water (including TSS®) + Central heating

35. User's instruction panel.

36. ☰ Domestic hot water temperature adjustment

37. ☰ Heating flow temperature adjustment

38. ○ Green indicator - Power ON

39. 🟡 Orange indicator - Burner ON

40. 🟠 Red indicator - Lock out / flame failure

41. "RESET" Reset button

42. Mechanical clock

43. 🕒 Pressure gauge

Isolating Taps

19. CH Flow isolating valve

21. Gas service tap

22. Water service tap

23. CH Return isolating valve

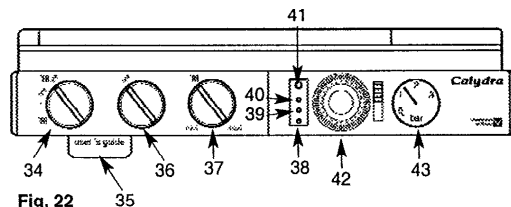

Fig. 22

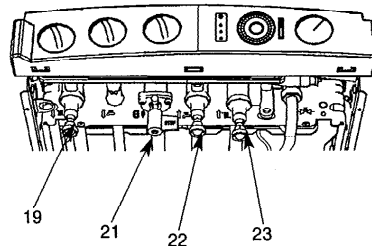





Fig. 23

User's instructions (continued)





Switching on

- 1) Check that the gas service tap is opened at the gasmeter and main power is on.
- 2) Check that pressure in central heating system is above 0.7 bar and below 2.5 bar with the pressure gauge  (43 fig. 23).
- 3) Open the gas tap (21 fig. 23) by turning from right to left.
- 4) The boiler is now ready to use.

Hot Water

- 1) Turn selector switch (34 fig. 22) to position . The green "power on" indicator  will light.
- 2) Turn on a hot water tap, the orange "burner on" indicator  will light and the water will become hot.

Heating and Hot Water

- 1) Turn selector switch (34 fig. 22) to position  . The green "power on" indicator  will light.
 - 3) If the room thermostat (if fitted), the heating control  and the clock (if fitted) are all calling for heat, the orange "burner on" indicator  will light and the heating will be on.
- When there is a need for hot water while the heating is on, it is only necessary to turn on a hot tap. The heating will be

interrupted momentarily while the hot water is being delivered. The boiler will switch back automatically to heating when the tap is turned off. The TSS® feature may cause the boiler to light unexpectedly to maintain the temperature of the stored water. This is quite normal.

Heating only

- 1) If heating is required without the need for TSS® hot water storage, turn the selector switch (34 fig. 22) to position . For example, this feature would be used if the house is to remain heated without anyone using the hot water.

Note: If the boiler has been turned off for some time the first attempt to light it may result in a lockout . If this happens press the reset button (41 fig. 22) and the boiler will light.

To Turn Boiler Off Completely

- 1) Turn the selector switch (34 fig. 22) to the off position .
- 2) Turn the gas tap (21 fig. 23) from left to right "STOP".

Instruction for setting the built in clock

MECHANICAL PROGRAMMER

1. General layout

The mechanical clock covers a 24 hour period. Each tappet represents 20 minutes (A fig. 25). An override switch is located on the right hand side of the clock (B fig 25).

2. To set the time

To set the time of day, grasp the outer edge of the dial and turn slowly clockwise until the correct time is lined up with the arrow (C fig. 25).

3. To Set the "On" and "Off" times

The clock uses a 24hours system. e.g. 8 = 8.00 am and 18 = 6.00 pm. "ON" periods are set by sliding all tappets between the "ON" time and the "OFF" time to the outer edge of the dial. The tappets remaining at the centre of the dial are the "OFF" periods.

4. To select function mode

Put the selector switch (B) to symbol ☉ to control the boiler by the clock. Put the switch (B) to "1" to select permanent operation or to "0" to turn heating off permanently.

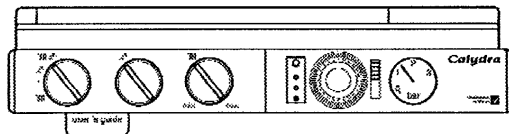

Fig. 24

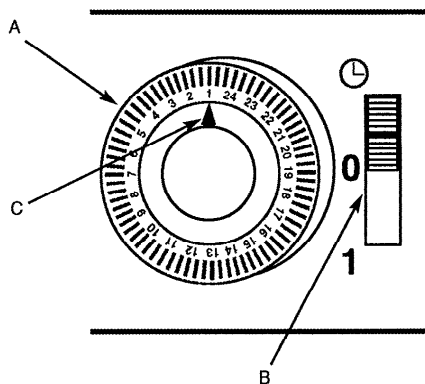

Fig. 25

Chaffoteaux et Maury are continuously improving their products and therefore reserve the right to change specifications without prior notice and accepts no liability for any errors or omission in the information contained in this document.

© Chaffoteaux et Maury 1998

Chaffoteaux et Maury Ltd
Trench Lock
Trench
Telford
Shropshire
TF1 4SZ

Tel: 01952 222727
Fax: 01952 243493

ESP 040 January 1999

Chaffoteaux
et Maury 

92220-150b - 10/98 AB488 ED7R09