

Users manual

ModuLink 250 RF - Twin channel modulating programmable room thermostat

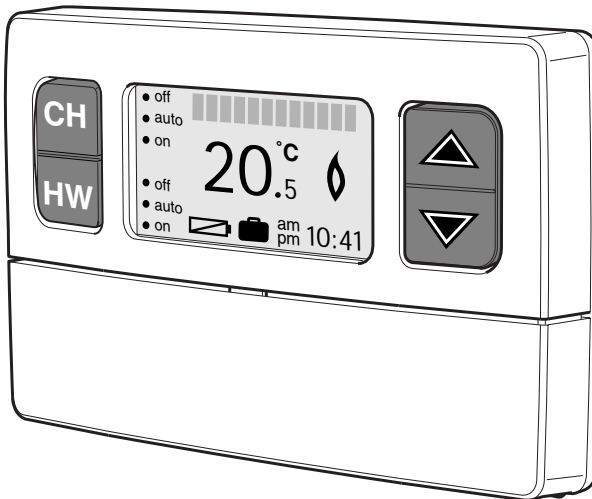

24 Volt only

Buderus

**Please read thoroughly before operating the unit
See boiler installation instructions for more details**

Menu overview:

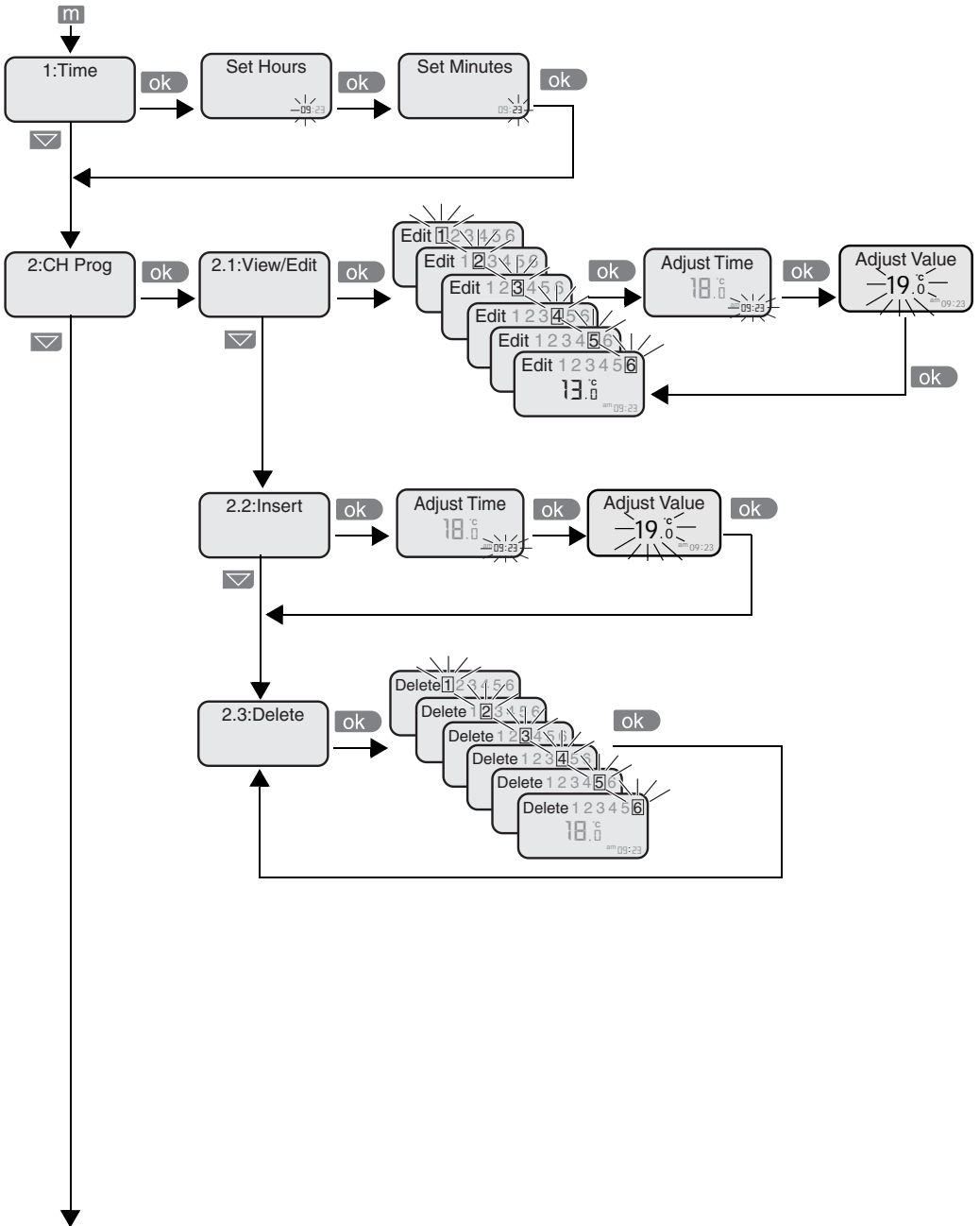

Menu overview (continued):

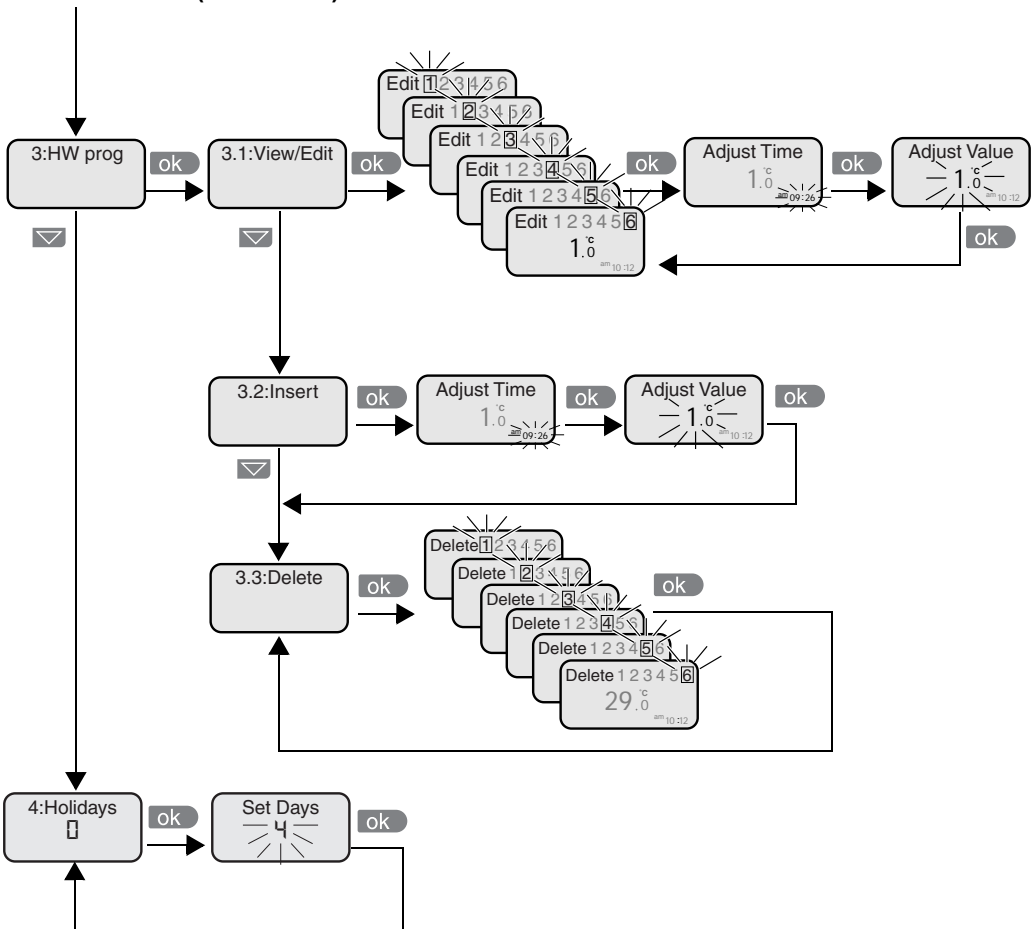



This product complies to the following regulations:

- EC directives:
 - Low Voltage Directive (73/23/EEC)
 - Electro Magnetic Compatibility Directive (89/336/EEC)
 - CE Marking Directive (93/68/EEC)
- Related Standards:
 - BS EN607730-1.

Overview (fig. 1)

Item 1. Central Heating button **CH**

With this button you select whether you want the thermostat for central heating **on**, **off** or on **auto**.

on: The boiler is now continuously 'on'. Set the temperature with the  and  keys.

auto: The boiler will now operate according to the set CH program.

off: Continuously 'off', but the frost protection programme is active. This means that when the room temperature drops below 5° Celsius the boiler will be activated.

Item 2. Domestic Hot Water button **HW**

With this button you can select whether you want the Domestic Hot Water program **on**, **off** or on **auto**. To select the preferred setting, the type of boiler has to be identified:

Combi boiler

on: The boiler will deliver instantaneous hot water (warmstart)

auto: The boiler will deliver instantaneous hot water according to the hot water program

off: The boiler will not deliver instantaneous hot water or will deliver no hot water depending on the type of boiler.

System boiler (only if the Buderus hot water sensor is installed):

on: The hot water cylinder will deliver instantaneous hot water

auto: The hot water cylinder will deliver instantaneous hot water according to the hot water program

off: The hot water cylinder will deliver no hot water.

Item 3. CH - Display

The display shows the current setting of the thermostat (fig. 2, item 5), the current temperature during standby (fig. 2, item 4), and the current time (fig. 2, item 1).

A symbol of a suitcase (fig. 2, item 2) is shown when the holiday function is active.

A symbol of a battery (fig. 2, item 3) is shown when the batteries should be replaced.

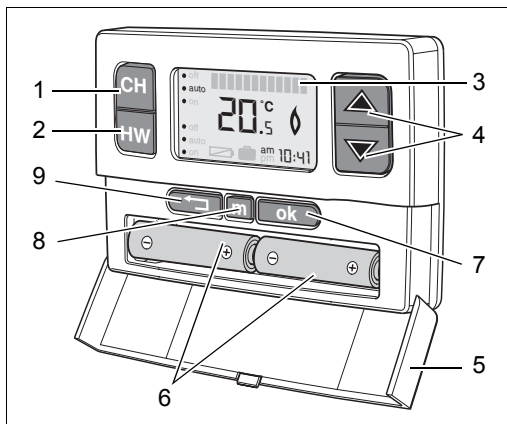

fig. 1 Thermostat overview

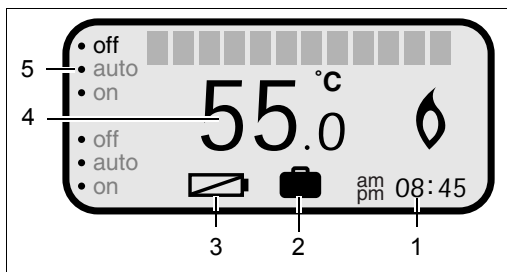

fig. 2 CH - Display

Item 4. HW - Display

The display shows the current setting of the thermostat (fig. 3, item 4), the current temperature during standby (fig. 3, item 5), and the current time (fig. 3, item 1).

A symbol of a suitcase (fig. 3, item 2) is shown when the holiday function is active.

A symbol of a battery (fig. 3, item 3) is shown when the batteries should be replaced.

Item 5. and buttons

Use these buttons to adjust the temperature. This is permanent when the thermostat is set to 'on'. When the thermostat is set to 'auto', you can temporarily change the temperature of a setpoint. The thermostat will go back to its CH program when the next set point begins.

The buttons can also be used to navigate within the menu.

Item 6. Cover

To open the cover, pull on the side.

Item 7. Batteries

The thermostat runs on two 1.5V type AA **Alkaline** batteries. The batteries will last for at least two years. A symbol of a battery (fig. 2, item 4) will appear if the batteries should be replaced. Once the battery replacement is carried out, you need to set the time. All other settings are kept.

Item 8. OK button

This button is pressed to confirm/save settings.





Item 9. Menu button





Press this button to enter and exit the menu.

Item 10. Back button

This button allows you to go back one menu level.

Setting the time

Press . Press  and use the  and  keys to set the hours. The range is from 0-24 hours or 1-12 a.m. and 1-11 p.m.. Once you scrolled through the 24h format using the up key, it changes to the 12h format.

Press  again. Use the  and  keys to set the minutes and press  to confirm.

Press  to return to the regular display.

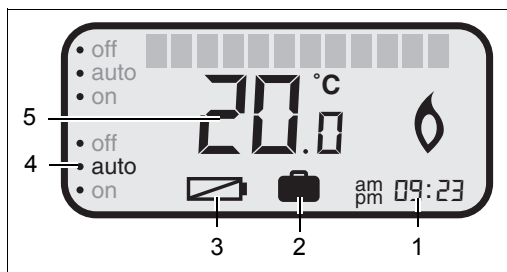

fig. 3 HW - Display

View/edit set point(s) for CH or HW

There are six set points possible. These set points are for a 24 hour period and are repeated each day of the week. Factory setting:

CH program	HW Program
06:30 a.m. – 21.0 °C	06:30 a.m. – 1 (on)
08:30 a.m. – 16.0 °C	08:30 p.m. – 0 (off)
12:30 p.m. – 21.0 °C	12:30 p.m. – 1 (on)
02:00 p.m. – 16.0 °C	02:00 p.m. – 0 (off)
04:30 p.m. – 21.0 °C	04:30 p.m. – 1 (on)
10:30 p.m. – 8.0 °C	10:30 p.m. – 0 (off)

1. Press **m** to enter the menu.
2. Press **▼** to go to the menu item 'CH prog' or 'HW prog' then press **ok**.
3. Press **ok** again to view/edit the set points. Use the **▲** and **▼** keys to scroll through the set points.
4. Press **ok** when you want to edit a set point.
5. Use the **▲** and **▼** keys to adjust the time and confirm with **ok**.
6. Adjust the temperature using the **▲** and **▼** keys and confirm with **ok**.
7. Press **m** to return to the regular display.

Current set point

To see what the current set point is for CH, press the CH button once. Press the HW button once for the current HW set point.

Insert a set point for CH or HW

1. Press **m** to enter the menu.
2. Press **▼** to go to the menu item 'CH prog' or 'HW prog' then press **ok**.
3. Press **▼** to go to 'insert' then press **ok**.
4. Use the **▲** and **▼** keys to enter the time and press **ok**.
5. Use the **▲** and **▼** keys to enter the desired temperature for the CH program or select '0' to turn the DHW off or select '1' to turn the DHW on then press **ok**.
6. Press **ok** to insert another set point as starting from step 4 or press **m** to return to the regular display.

The set point will automatically arrange itself to the correct position within the program.

Delete a set point for CH or HW

1. Press **m** to enter the menu.
2. Press **▼** to go to the menu item 'CH prog' or 'HW prog' then press **ok**.
3. Press **▼** to go to 'delete' then press **ok**.
4. Select the set point you want to delete using the **▲** and **▼** keys then press **ok**.
5. Press **ok** to delete another set point starting from step 4 or press **m** to return to the regular display.

Holiday function

The holiday function allows you to set the CH temperature to frost protection (5° Celsius) for up to 99 days and to turn the HW function to "0".

1. Press **m** to enter the menu.
2. Press **▼** to go to 'Holiday' then press **ok**.
3. Enter the number of days using the **▲** and **▼** keys then press **ok**.
4. Press **m** to return to regular display.

A suitcase can be seen in the display when the Holiday function is active (see fig. 2, item 3). The CH and HW will automatically switch to 'Auto'. The 'Auto' mode while the holiday function is active, means that the CH temperature is set to frost protection (5° Celsius) and that HW is set to "0". Afterwards the thermostat automatically reverts back to the CH/HW program.

To terminate the holiday function set the number of days to '0'.

It is possible to temporarily interrupt the Holiday function. Set the thermostat to 'on' using the **CH** button. Set the thermostat back to 'auto' using the **CH** button to return to the Holiday function.

Notes

Buderus

Heating system specialist:

Buderus
Cotswold Way
Warndon
Worcester
WR4 9SW

Telephone: 01905 - 752 936
Fax: 01905 - 753 130

Customer Services: Tel: 0870 - 421 5933
Technical Product Support: Tel: 0870 - 421 5944
Sales: Tel: 01905 - 752 640 Fax: 01905 - 456 445 / 455 394
Returns: Tel: 01905 - 752 531 Fax: 01905 - 455 392
Spares: Tel: 01905 - 752 576 Fax: 01905 - 754 620

www.buderus-domestic.co.uk

Buderus is a trading name of BBT Thermotechnology UK Ltd.