

Please keep these Instructions safe.
Should you move house, please hand
them over to the next occupier.

Baxi Bermuda GF3/LFE5 Super

Fireside Gas Central Heating Units

User's Operating Instructions

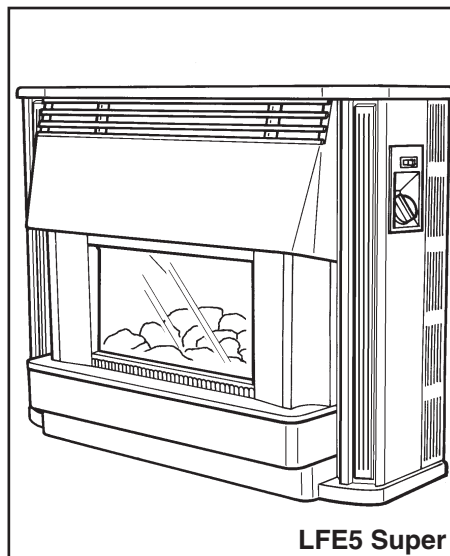
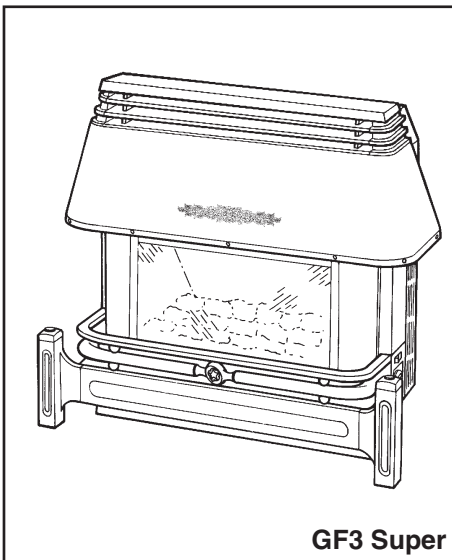

BAXI

Natural Gas

Baxi Bermuda GF3 Super
G.C.No. 37 077 59
Baxi Bermuda LFE5 Super
G.C.No. 37 077 61

For use with the following boilers:

Baxi Bermuda 45/4 M
G.C.No. 44 077 71
Baxi Bermuda 45/4 E
G.C.No. 44 077 73
Baxi Bermuda 57/4 M
G.C.No. 44 077 72
Baxi Bermuda 57/4 E
G.C.No. 44 077 74

Propane Gas

Baxi Bermuda GF3 Super Propane
G.C.No. 37 077 69

For use with the following boiler:

Baxi Bermuda 553 Propane
G.C.No. 44 077 75

Renewal

Baxi Bermuda GF3 Super Renewal
G.C.No. 37 075 01A
Baxi Bermuda LFE5 Super Renewal
G.C.No. 37 075 03A

For use with the following boilers:

Baxi Bermuda 401
G.C.No. 44 077 49
Baxi Bermuda 552
G.C.No. 44 077 50
Baxi Bermuda 45/3 M
G.C.No. 44 077 61
Baxi Bermuda 45/3 E
G.C.No. 44 077 60
Baxi Bermuda 57/3 M
G.C.No. 44 077 63
Baxi Bermuda 57/3 E
G.C.No. 44 077 62
Baxi Bermuda 45/4 M
G.C.No. 44 077 71
Baxi Bermuda 45/4 E
G.C.No. 44 077 73
Baxi Bermuda 57/4 M
G.C.No. 44 077 72
Baxi Bermuda 57/4 E
G.C.No. 44 077 74

Baxi UK Limited is one of the leading manufacturers of domestic heating products in the UK.

Our first priority is to give a high quality service to our customers. Quality is built into every Baxi product - products which fulfil the demands and needs of customers, offering choice, efficiency and reliability.

To keep ahead of changing trends, we have made a commitment to develop new ideas using the latest technology - with the aim of continuing to make the products that customers want to buy.

Everyone who works at Baxi has a commitment to quality because we know that satisfied customers mean continued success.

We hope you get a satisfactory service from Baxi. If not, please let us know.



Baxi is a BS-EN ISO 9001
Accredited Company

Introduction

Your Baxi Bermuda GF3 Super or LFE5 Super is a central heating boiler combined with a gas fire. Normally the fire will heat the room in which it is situated and the boiler will provide heating for the rest of the house and also domestic hot water if required. The boiler and fire are independently controlled.

The boiler may be controlled by an external programmer or clock control (see separate instructions with the clock controller used). The fire is controlled by the knob which is located on the right hand side of the outer case.

Important Notice

The Bermuda GF3 Super Propane appliance is for use on **PROPANE GAS ONLY** and cannot be used on any other gas. Propane appliances can be converted to operate on Natural Gas if required at a later date. Consult your Installer or British Gas Service.

WARNING:- Bermuda GF3 Super and LFE5 Super Renewal Firefronts **MUST NEVER** be fitted as independent gas fires without the boiler.

Important Information

This product uses a fuel effect coal bed containing Refractory Ceramic Fibres (R.C.F.) which are man-made vitreous silicate fibres. Excessive exposure to these materials may cause temporary irritation to eyes, skin and respiratory tract. Care must be taken when handling these articles to ensure the release of dust or fibres is kept to a minimum. Refer to the section Cleaning the Fire on page 6.

All CORGI registered installers carry a CORGI identification card and have a registration number. Both should be recorded in your boiler Log Book. You can check your installer is registered by telephoning 01256 372300 or writing to:-

1 Elmwood,
Chineham Business Park,
Crockford Lane,
Basingstoke.
RG24 8WG.

"Benchmark" Installation, Commissioning and Service Record Log Book

Please ensure that your installer has completed the Installation and Commissioning sections of the Log Book, and hands the Log Book over. The details of the Log Book will be required in the event of any warranty work. Keep the Log Book in a safe place and ensure that the relevant sections are completed at each subsequent regular service visit.

OPERATING THE UNIT

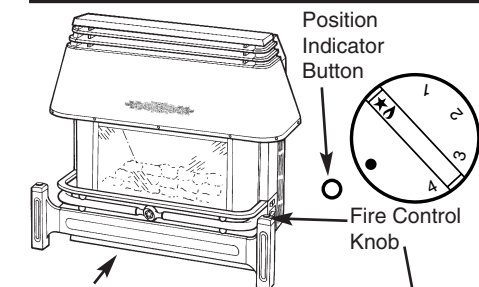

Controls Cover Panel
GF3 Super

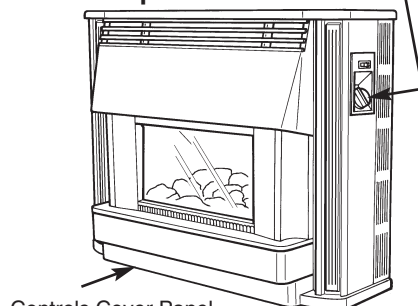

Controls Cover Panel
LFE5 Super

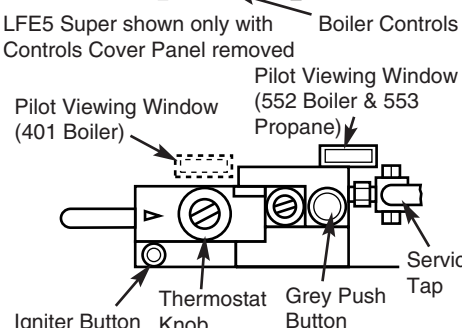
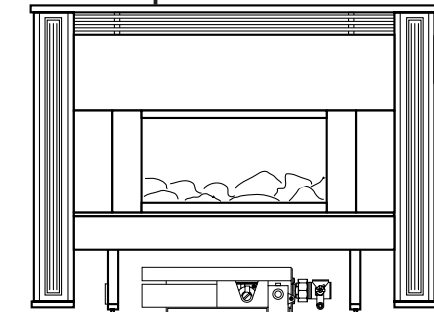

Manual Controls Boiler

(401, 552 & 553 Propane)

Pilot Viewing Window (Series 4)

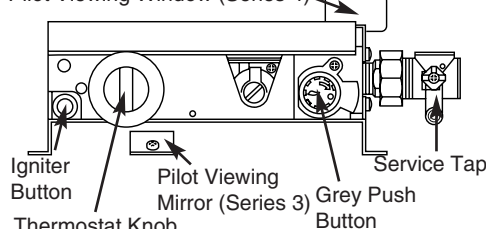

Manual Controls Boiler

(45/3M, 57/3M, 45/4M & 57/4M)

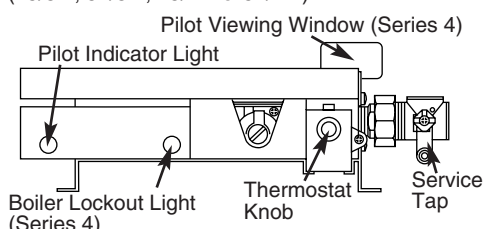

Electronic Controls Boiler

(45/3E, 57/3E, 45/4E & 57/4E)

1 Push in and turn the fire control knob to the OFF position (●).

2 Remove the controls cover panel at the bottom of the fire below the coal bed by grasping it firmly by its side edges and pulling forwards.

3 Turn the boiler thermostat knob to the OFF position (●).

Manual Controls Boiler



Electronic Controls Boiler

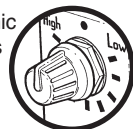

4 Ensure the main gas and electricity supplies are turned on.

5 TO LIGHT THE BOILER PILOT: (Manual Controls Boiler) Hold in the grey push button on the gas control valve. Looking through the pilot viewing window: Press the igniter button and release. Repeat until the pilot lights. Continue to hold in the grey push button for a further 15 seconds. The pilot should stay alight.

NOTE: If the pilot fails to remain alight or is extinguished at any time, wait at least 3 minutes then repeat step 5. Once the pilot is alight it may be left on permanently.

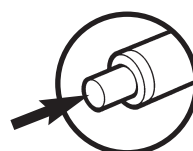

Igniter Button

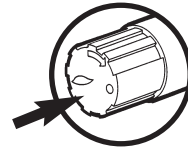

Grey Push Button

6 TO LIGHT THE BOILER: (Manual Controls Boiler) Ensure that all external controls, e.g. room thermostat, timer etc., are calling for heat. Turn the boiler thermostat knob to the desired position.

7 TO LIGHT THE BOILER: (Electronic Controls Boiler) Ensure that all external controls, e.g. room thermostat, timer etc., are calling for heat. To operate the pilot turn the thermostat knob to the desired position. The green neon light on the control box will illuminate once the pilot is lit. The burner will also light shortly after the pilot has been established. The pilot is intermittent and only lights when the boiler thermostat is calling for heat.

To adjust the boiler temperature: Turn the boiler thermostat knob clockwise to the required setting. The optimum boiler thermostat setting depends upon type of system, external controls and your requirements. Your Installer will be able to advise you on this matter.
If the boiler cannot be lit by the above method consult your Installer or British Gas Service.

8 RESETTING THE BOILER: (Electronic Controls Boiler)

If the boiler lockout light is illuminated it is necessary to reset the appliance. To do this turn the boiler thermostat control knob fully anti-clockwise to the OFF position and wait 10 seconds. Turn the control knob to the required setting. The boiler will commence sparking providing the water temperature is sufficiently cool.

9 TO LIGHT THE FIRE: Push in and turn the fire control knob anti-clockwise to the positive stop at position "★♠". Just before position "★♠" is reached, a click will be heard and the pilot should light, hold in the control knob for approx 15 seconds, release and turn to desired position. The pilot can be seen through the lower right hand gap between the coals and front panel. If the burner fails to light, turn the control knob to the OFF position (●) and repeat until the burner lights. Continue to hold in the control knob for a further 15 seconds. Release slowly and the burner should stay alight.

CAUTION - If the burner does not light or stay alight, or if the flame goes out for any reason, turn the control knob to the OFF position (●) and wait for 3 minutes before attempting to light the burner.

NOTE: An electrical supply is not needed to ignite the fire.

CONTROL KNOB POSITIONS: The control knob has six positions giving a choice of 5 settings, i.e.

- Position ● - OFF
- Position ★♠ - IGNITION/PILOT
- Position 1 - LOW
- Position 2 - MED
- Position 3 - MED/HIGH
- Position 4 - HIGH

To adjust the fire to the required setting, push in the control knob and turn in the appropriate direction.

10 TO TURN THE FIRE OFF: Push in the control knob and turn clockwise to the OFF position.

The pilot light can be left on by stopping at the "★♠" position but the fire is not completely off until the control knob is turned to position ●.

NOTE: When your Bermuda is first used it is possible that certain smells may be emitted. These smells will quickly clear with use. As the fire is used more and more, the bright finished metal around the coal bed will begin to darken. This is perfectly normal and will enhance the realism of the coal and flame effect.

Most heating appliances generate warm air convection currents and transfer heat to any wall surface against which they are situated. Some soft wall furnishings (such as blown vinyl wallpapers) may not be suitable for use where they are subjected to temperatures above normal room levels. The manufacturers advice should be sought before using this type of wall covering adjacent to any heating appliance. The likelihood of wall staining from convected air currents will be increased in environments where high levels of tobacco smoke or other contaminants exist.

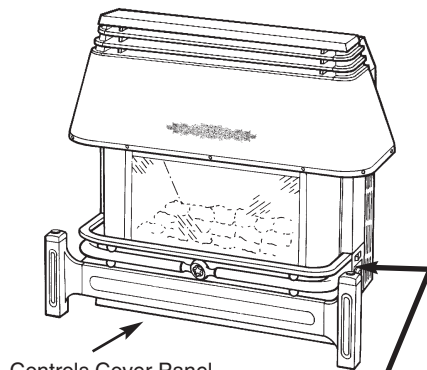

Controls Cover Panel

GF3 Super

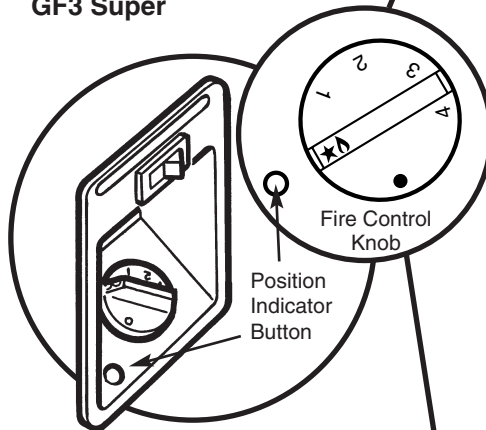

Fire Control Knob

Position Indicator Button

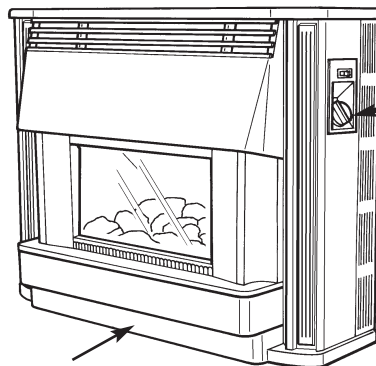

Controls Cover Panel

LFE5 Super

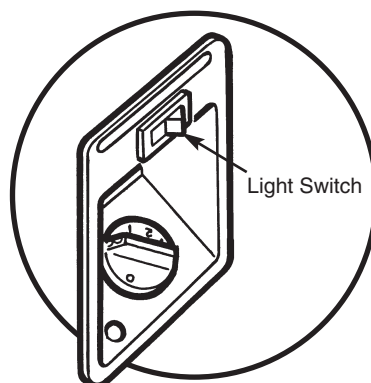

Light Switch

LIGHT EFFECT

The light effect is operated by a switch above the control knob (O denotes OFF and  denotes ON) and may be used either with or without the fire being on.

TO SHUT DOWN THE BOILER

Turn the fire control knob to the OFF position (●), switch the bulbs OFF and allow the fire to cool.

Remove the controls cover panel at the bottom of the fire below the coalbed by grasping it firmly by its side edges and pulling forwards.

To switch the boiler off for short periods. (Manual Controls Boiler)

Turn the boiler thermostat knob to the OFF position (●). The pilot will remain alight.



To switch the boiler off for long periods. (Manual Controls Boiler)

Turn the grey push button clockwise and release. Turn the boiler thermostat knob to the OFF position (●).

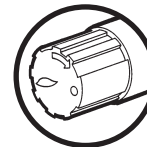

To switch the boiler off. (Electronic Controls Boiler) Turn the thermostat knob to the OFF position (●).



If you are shutting down both the fire and boiler, isolate the electrical supply that serves the system controls i.e. Timer/Programmer.

Replace the controls cover panel.

NOTE: If the boiler is left off for long periods during cold weather, it is recommended that the whole system is drained to avoid frost damage. Advice on draining the system can be obtained from your installer or British Gas Service.

GUARDING

The glass front panel on this appliance conforms to the required safety standards. It does not give full protection to the young or infirm: in such cases we recommend a nursery type guard which conforms to BS 6539. The panel becomes very hot when the appliance is in use and must not be touched.

THE APPLIANCE MUST NEVER BE USED WITHOUT THE GLASS FRONT PANEL FITTED.

The minimum clearance spaces around the Baxi Bermuda GF3 Super are:

Top: 76mm (3 in)
 Left Hand Side: 25mm (1 in)
 Right Hand Side: 76mm (3 in)

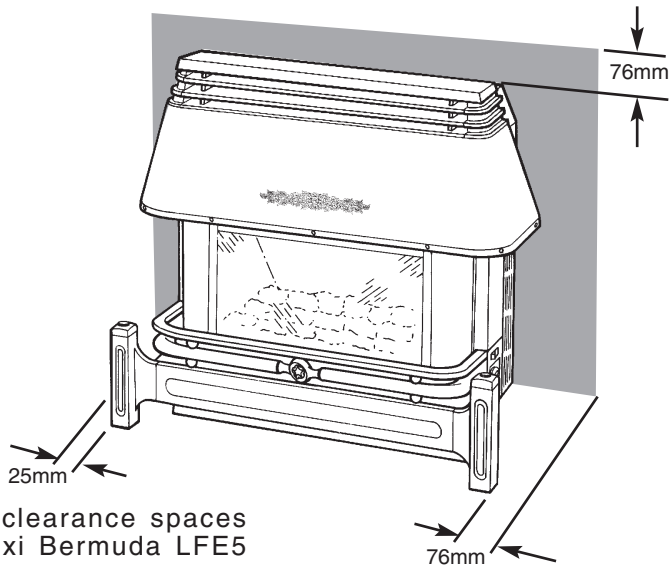

The minimum clearance spaces around the Baxi Bermuda LFE5 Super are:

Top: 76mm (3 in)
 Left Hand Side: 25mm (1 in)
 Right Hand Side: 76mm (3 in)

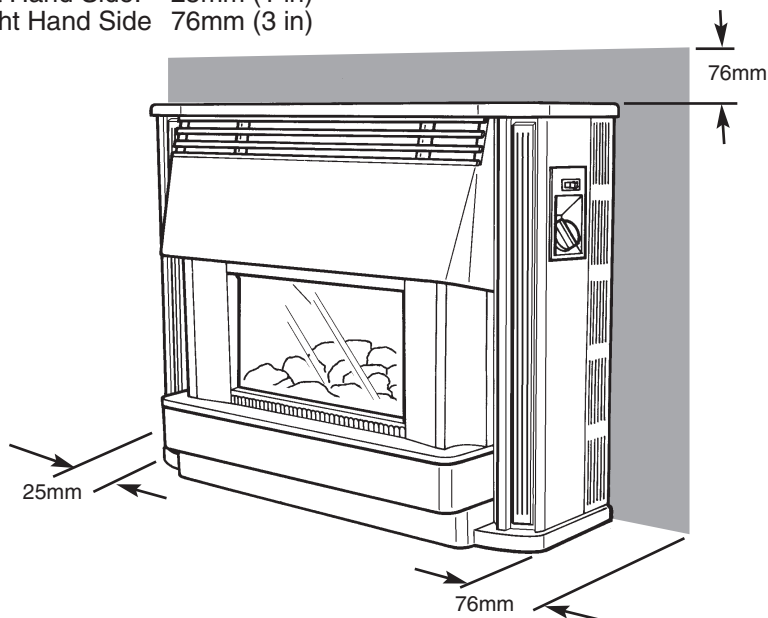

CLEARANCES AROUND THE FIRE

These clearances must not be reduced or obstructed in any way.

All clearances are essential in order to allow correct servicing of the appliance and access to the fire control knob.

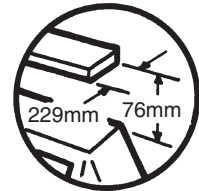

A shelf may be fitted not less than 76mm (3 in) above the fire and not more than 229mm (9 in) in depth.

SPARE PARTS

Any repairs to the appliance during the guarantee period will usually be the responsibility of the installer, after which spare parts may be obtained through an approved Baxi stockists.

The spare parts available and their relevant G.C. numbers can be found at the back of the installation and servicing instructions booklet.

The appliance name and G.C. number, which are on the data badge, should always be quoted. The data badge is visible on the left hand fire support leg when the controls cover panel is removed.

Warnings

IN CASE OF GAS LEAKS

If a gas leak is found or suspected, turn off the gas supply at the meter immediately and contact your Installer or Transco (under 'Gas' in the phone directory).

NEVER HANG CLOTHES OR OTHER ITEMS OVER THE APPLIANCE.

SERVICING YOUR BERMUDA

We strongly recommend that your Bermuda is serviced annually for reasons of safety and economy. Your Installer or British Gas Service will be able to advise you.

THIS APPLIANCE MUST BE EARTHED

Electricity supply: A standard 230 volt ~ 50Hz supply is required. The appliance must be protected by a 3 amp fuse.

SAFE INSTALLATION

Installation of this appliance must be carried out by a CORGI Registered Installer or other competent person and be in accordance with the relevant requirements of the GAS SAFETY (Installation and Use) REGULATIONS, CURRENT I.E.E. WIRING REGULATIONS and any other regulations applying in your area.

NEVER OPERATE A FAULTY APPLIANCE.

REMOVAL OF GLASS FRAME

CAUTION: The appliance must never be used without the glass front panel fitted. Should the glass front panel become damaged or cracked the fire should not be used until it has been replaced.

NOTE: This is a heat resistant glass and must not be replaced by ordinary glass. Some small blemishes may be seen in the glass. These are inherent in its manufacture and will not affect its performance or durability.

Ensure that the fire and bulbs are cold.

Withdraw the electric plug from the socket behind the controls cover panel.

Carefully remove the fender and reflector assembly by first lifting the assembly upwards to clear the panel on which it rests and then swing its lower edge forwards, ensuring that the assembly does not contact the panel below.

Slide the glass retaining clamps sideways.

Lift the glass front panel bottom edge out of the locating channel. Carefully remove the front panel by pulling the bottom edge forwards and downwards.

Re-assemble carefully in reverse order of dismantling ensuring that the glass front panel rope seal is undamaged.

IGNITION WITH A MATCH

Ensure that the fire and bulbs are cold. Withdraw the electrical plug from the socket behind the controls cover panel. Remove the glass front panel as described in 'Removal of Glass Frame'. Apply a lighted match to the lower right hand gap between the coals and front panel. Push in and turn the fire control knob anti-clockwise to the positive stop "★▲" and the pilot should light. Continue to hold in the control knob for a further 15 seconds. Release slowly and the pilot should stay alight. Refit the glass panel, replace the reflector and reconnect the electrical plug.

REPLACING THE BULBS

Ensure that the fire and bulbs are cold. Isolate electrical supply.

Carefully remove the fender and reflector assembly complete as described in Removal of Glass Frame. The lamps can now be replaced (max 60W - red). Re-assemble in reverse order.

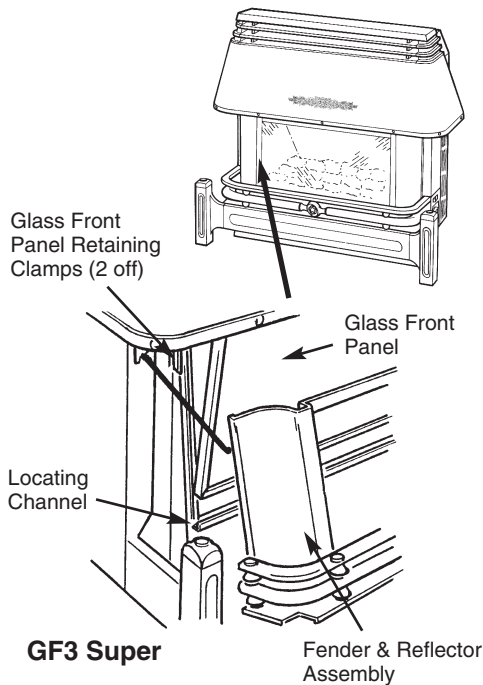

GF3 Super

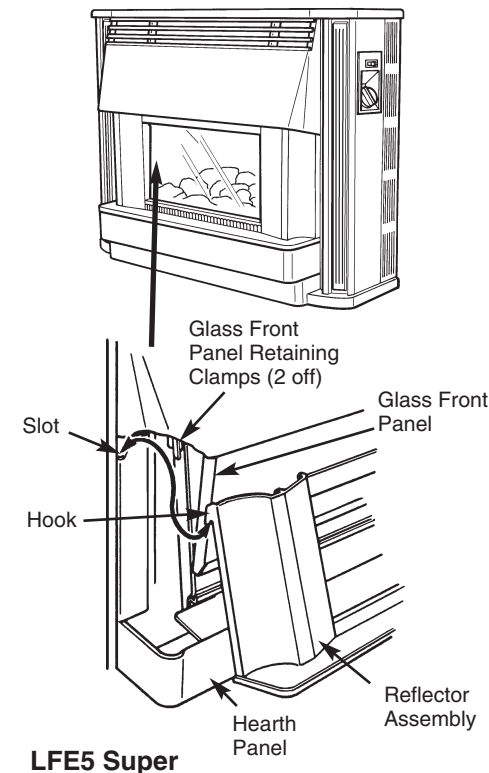

LFE5 Super

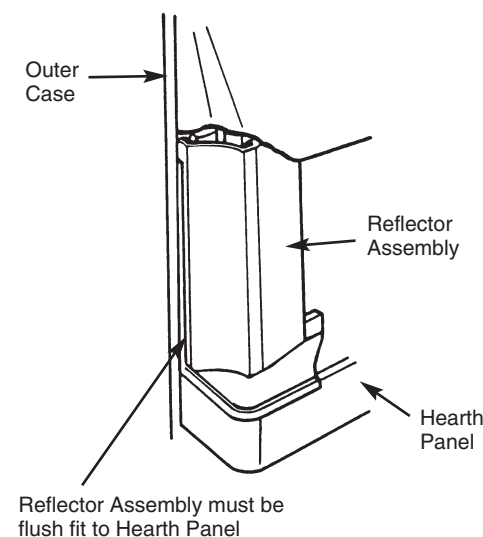

Reflector Assembly must be flush fit to Hearth Panel

CLEANING THE FIRE

Ensure that the fire is cold. The painted panels and metalwork should be wiped with a damp cloth and dried thoroughly with a lint-free cloth. Do not use a silicone based polish on the timber parts of the LFE5 Super outercase. The glass front panel can be cleaned on the inside face by first removing as described in Removal of Glass Frame. Clean the glass regularly for the best results using a non-abrasive cream cleanser.

It is possible that some soot may be deposited on the coals after use. This is acceptable providing it is not allowed to accumulate.

Should any soot accumulation become excessive the fuel effect coal bed should be removed from the fire for cleaning. To remove the coal bed it is necessary to remove the glass front panel. It is recommended that gloves are worn when handling the coal bed, which is extremely fragile and must be handled accordingly. Cleaning should be carried out in a well-ventilated area or the open air by gently brushing with a soft brush with the coal bed held away from the face to avoid inhaling the dust. The use of a normal domestic vacuum cleaner is not recommended as it may blow dust back into the air. Care must also be taken if retouching the coal bed is required. Keep the coal bed away from children at all times. Never use coals other than those supplied or Genuine Baxi Spare Parts. Never put additional coals on the fire. Always wash hands thoroughly after handling the coal bed.

Please read the Important Information section on page 3.

The coal bed may be retouched using black stain. This is available direct from Baxi Limited or your local Baxi Spares stockist. Quote Part No 043224 when ordering.

SURROUND OR WALL FINISH

The surround or wall finish must have a flat vertical area centrally placed about the opening.

If a surround is fitted, any gaps between it and the wall must be sealed and it must have a rating of 100° C or higher.

PILOT / A.S.D.

Both the boiler and firefront are fitted with a pilot light that also acts as an Atmospheric Sensing Device. This means that in the event of the flow of gases out of the flue being interrupted, the pilots will extinguish and shut the fire and boiler down. If this occurs persistently your installer or British Gas Service should be contacted immediately. On a renewal model installed with a 401, 552, 45/3 or 57/3 the boiler will not shut down. The fire will only shut down when used on its own. It is important that the appliance is regularly serviced to ensure correct operation of the Atmospheric Sensing Device.

GUARANTEE

Your Baxi Bermuda is designed and produced to meet all the relevant British Standards.

Baxi UK Limited provide a 12 month guarantee on the Bermuda - other parts of the system are covered by the Installer or other manufacturers. The guarantee operates from the date installation is completed for the customer who is the original user.

To maximise the benefit from our guarantee we urge you to return the reply-paid guarantee registration.

This does not in any way prejudice your rights at Common Law. Such rights between the customer and the installer or supplier from whom the unit was purchased remain intact.

Any component or part (with the exception of the bulbs) which becomes defective during the guarantee period as a result of faulty workmanship or material whilst in normal use will be repaired or replaced free of charge.

Baxi UK Limited manufacture a comprehensive range of products for the domestic heating market

**Gas Central Heating Boilers
(Wall, Floor and Fireside models).**

Independent Gas Fires.

Renewal Firefronts.

Gas Wall Heaters.

Solid Fuel Fires.

If you require information on any of these products, please write to the Sales Department.

After Sales Service
08706 096 096

BAXI

Baxi UK Limited
Brownedge Road
Bamber Bridge Preston
Lancashire
PR5 6SN
www.baxi.com