

eco **GENUS**

Condensing

**Servicing
Instructions**

Type C Boilers

G.C.N: 41-116-03

47-116-17

**LEAVE THESE INSTRUCTIONS
WITH THE END-USER**

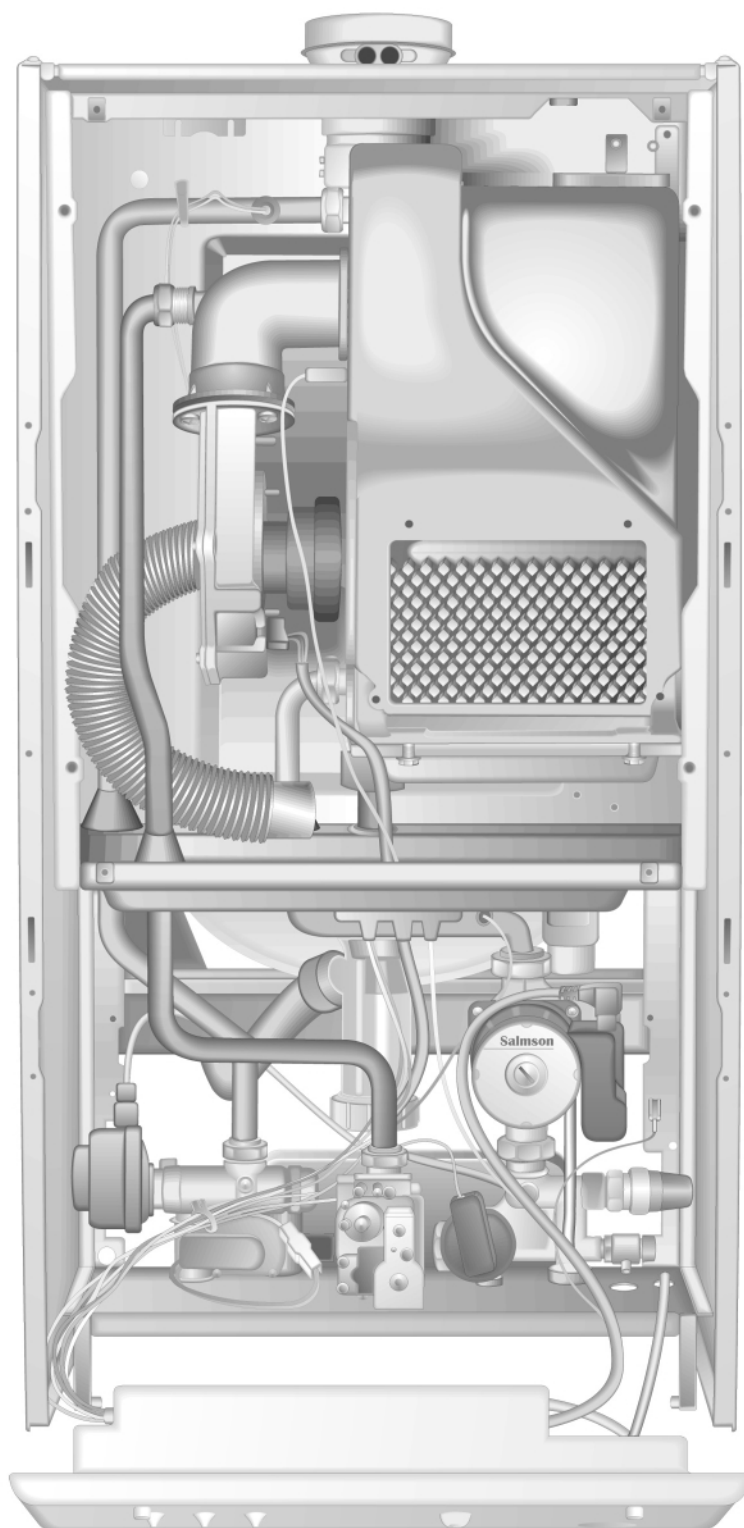

 **ARISTON**

Country of destination: GB

TABLE OF CONTENTS

1. **SERVICING INSTRUCTIONS**
 - 1.1 REPLACEMENT OF PARTS
 - 1.2 TO GAIN GENERAL ACCESS
 - Lowering the control panel and removing the front panel
 - Removing the side panels
 - 1.3 ACCESS TO THE COMBUSTION CHAMBER
 - Removing the sealed chamber front cover
 - Removing the fan
 - Removing the burner
 - Removing the electrodes
 - Removing the heat exchanger inspection panel
 - Removing the condensate collector
 - Removing the condensate trap
 - Removing the injector
 - 1.4 ACCESS TO THE GAS VALVE
 - Removing the gas valve
 - 1.5 ACCESS TO THE WATER CIRCUIT
 - Removing the D.H.W. (secondary) exchanger
 - Removing the safety valve
 - Removing the automatic air vent
 - Removing the main circuit flow switch
 - Removing the diverter valve actuator
 - Removing the D.H.W. flow switch
 - Removing the pump
 - Removing the pressure gauge
 - Removing the expansion vessel
 - Removing the D.H.W. temperature sensor (N.T.C.)
 - Removing the C.H. flow temperature sensor (N.T.C.)
 - Removing the C.H. return temperature sensor (N.T.C.)
 - 1.6 ACCESS TO THE CONTROL SYSTEM
 - Checking the fuses
 - Removing the time clock
 - Removing the P.C.B.s
2. **FAULT FINDING**
 - 2.1 FAULT FINDING GUIDE (FLOW-CHART)
3. **ELECTRICAL DIAGRAMS**
4. **SHORT SPARE PARTS LIST**

1. SERVICING INSTRUCTIONS

To ensure efficient safe operation, it is recommended that the boiler is serviced annually by a competent person.

Before starting any servicing work, ensure both the gas and electrical supplies to the boiler are isolated and the boiler is cool.

Before and after servicing, a combustion analysis should be made via the flue sampling point (please refer to the Installation Manual for further details).

After servicing, preliminary electrical system checks must be carried out to ensure electrical safety (i.e. polarity, earth continuity, resistance to earth and short circuit).

1.1 REPLACEMENT OF PARTS

The life of individual components vary and they will need servicing or replacing as and when faults develop.

The fault finding sequence chart in chapter 2 will help to locate which component is the cause of any malfunction, and instructions for removal, inspection and replacement of the individual parts are given in the following pages.

1.2 TO GAIN GENERAL ACCESS

All testing and maintenance operations on the boiler require the control panel to be lowered. This will also require the removal of the casing.

To lower the control panel and dismantle the front part of the casing, proceed as follows:

1. Unscrew screws "A" (1/4 turn only) (FIG. 1.1 + FIG. 1.2) and rotate the control panel forward;
2. Unscrew the screws "B" (FIG. 1.3) and unhook the front panel by lifting it.



Removing the side panels

1. Remove the screws "C" (FIG. 1.4);
2. Pull each panel away from the boiler, then lift the panel up and away from the boiler.

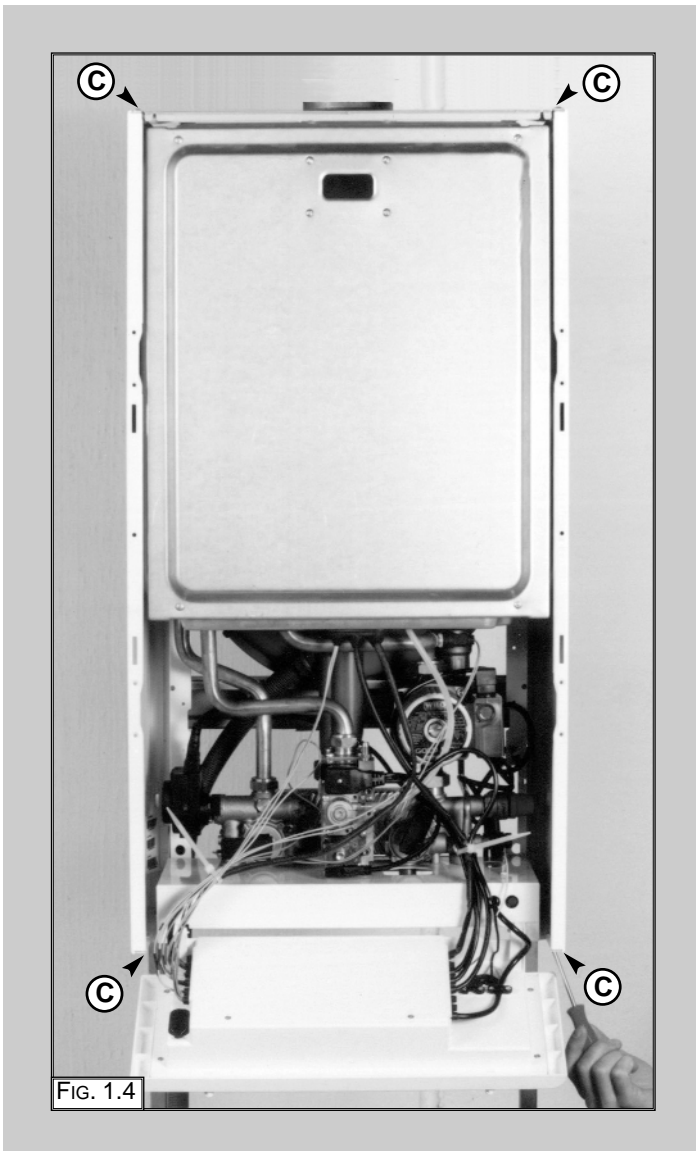

1.3 ACCESS TO THE COMBUSTION CHAMBER

Removing the sealed chamber front cover

1. Remove the screws "D" (FIG. 1.5);
2. Pull the cover away from the boiler (FIG. 1.6).



Removing the fan

1. Loosen nut "E" (FIG. 1.7);
2. Pull off the hose "F" and disconnect the electrical connector "G" (FIG. 1.8);
3. Remove the nuts "H" (FIG. 1.9);
4. Pull the fan away from the exchanger (FIG. 1.10).

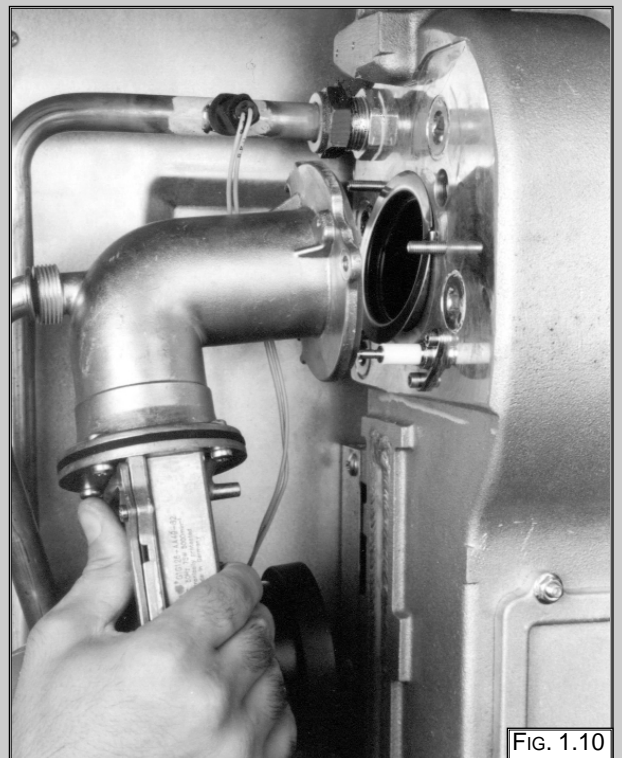
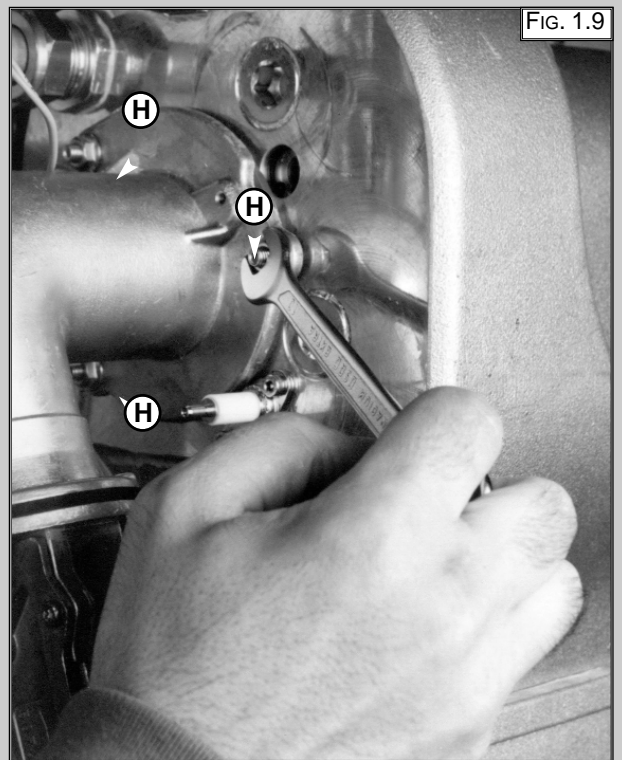
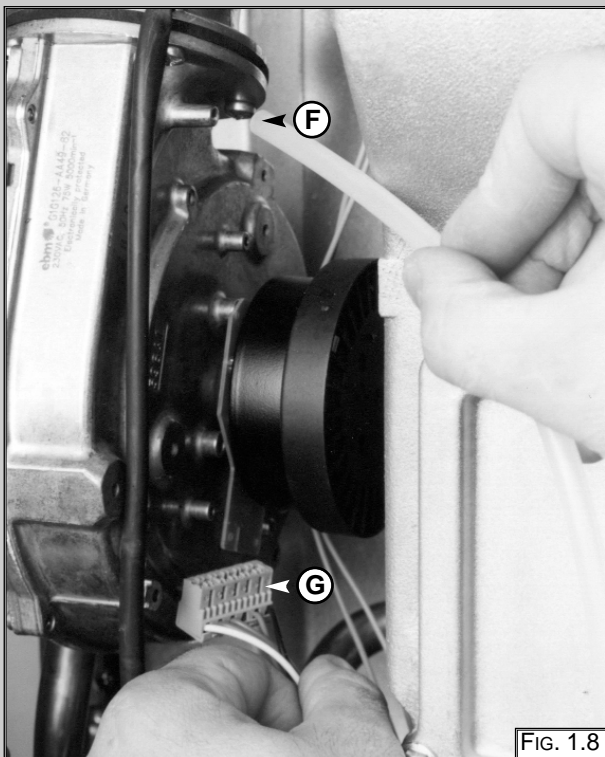

Removing the burner

With the fan removed (see previous section);

1. Slide the burner from its housing (FIG. 1.11).

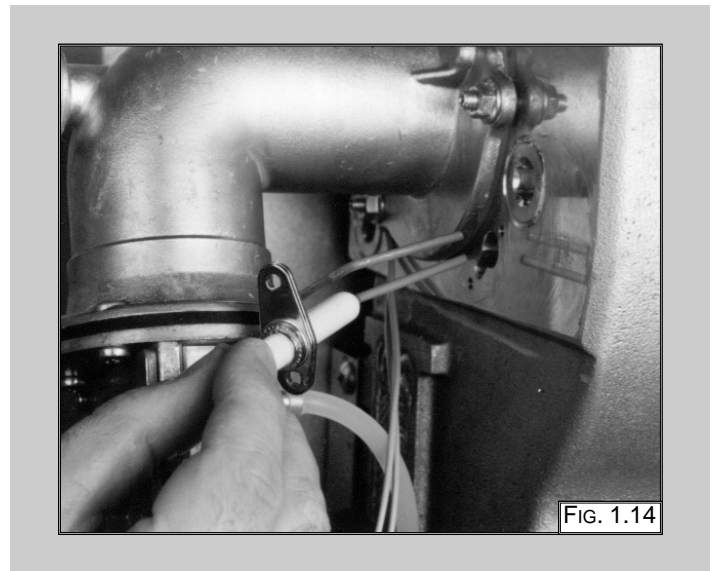
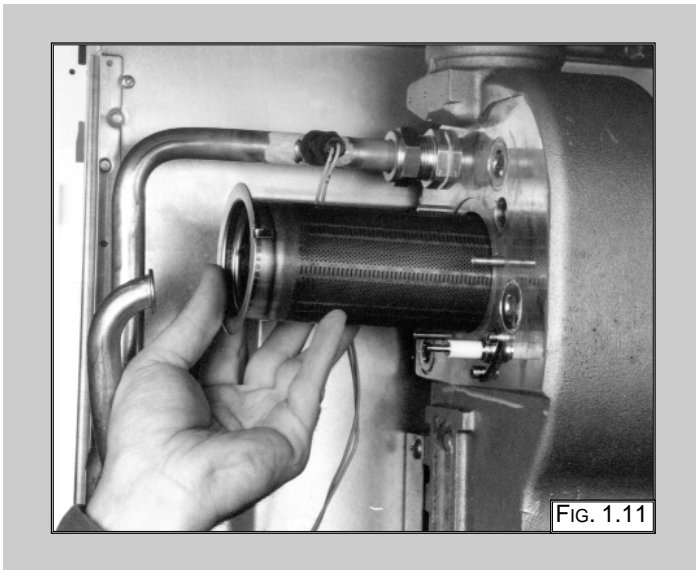

Removing the combustion chamber inspection panel

1. Remove the four nuts "K" (FIG. 1.15);
2. Remove the inspection panel (FIG. 1.16).

Removing the electrodes

1. Pull off the ignition cable "I" (FIG. 1.12);
2. Remove the two allen bolts "J" (FIG. 1.13);
3. Extract the electrodes (FIG. 1.14).

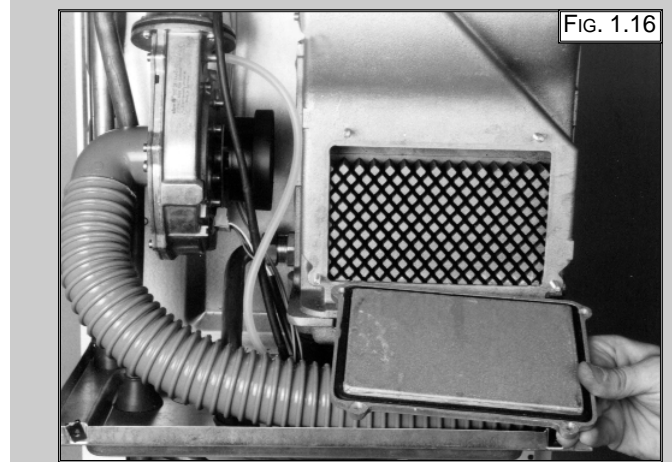
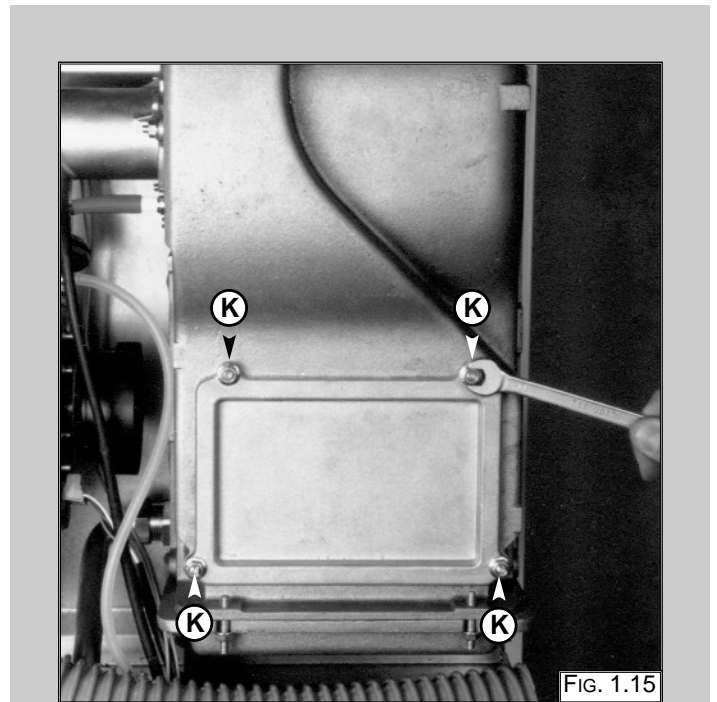
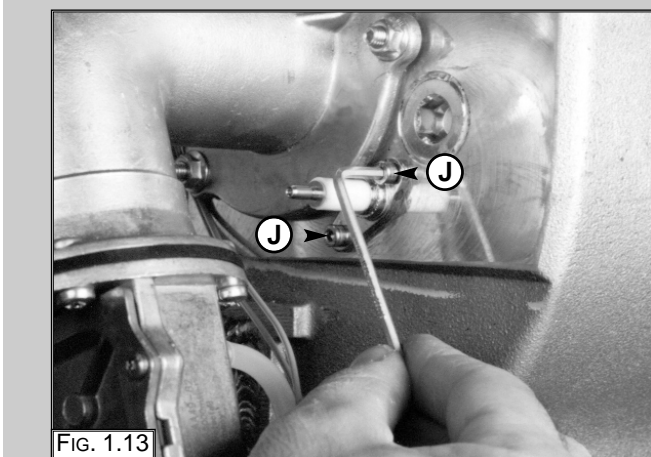
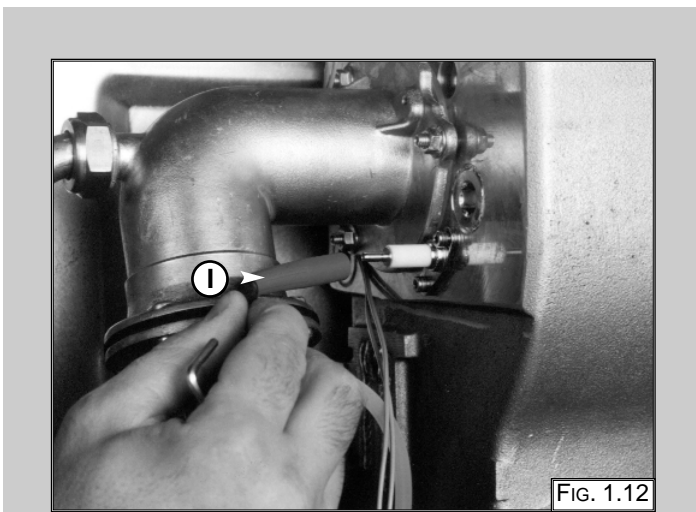

Removing the condensate collector

1. Remove the nuts "L" from each side of front of the collector (FIG. 1.17);
2. Remove the nuts "M" from each side of rear of the collector (FIG. 1.18);
3. Release the condensate trap union "N" (FIG. 1.19);
4. Separate the collector from the combustion chamber(FIG. 1.20);
5. Remove the condensate collector (FIG. 1.21).

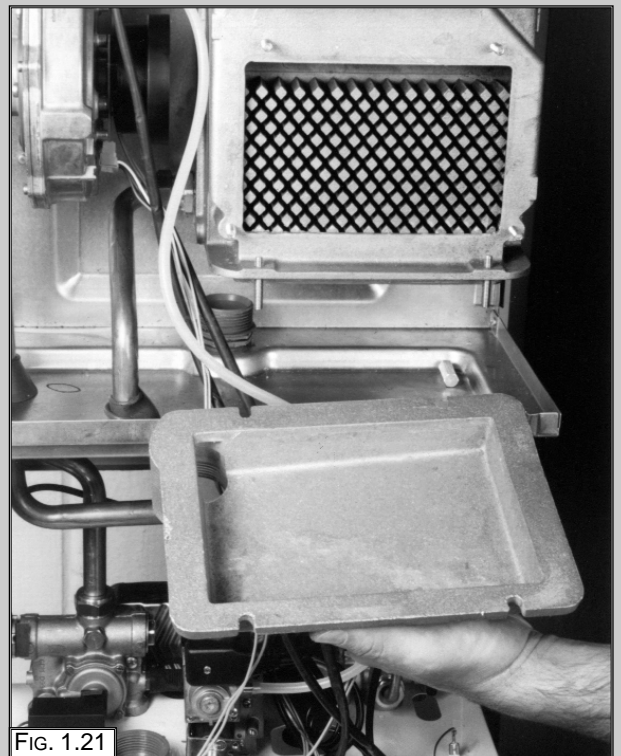
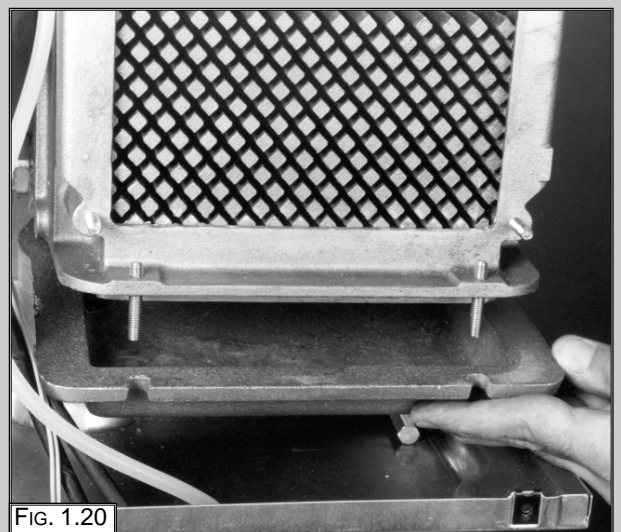
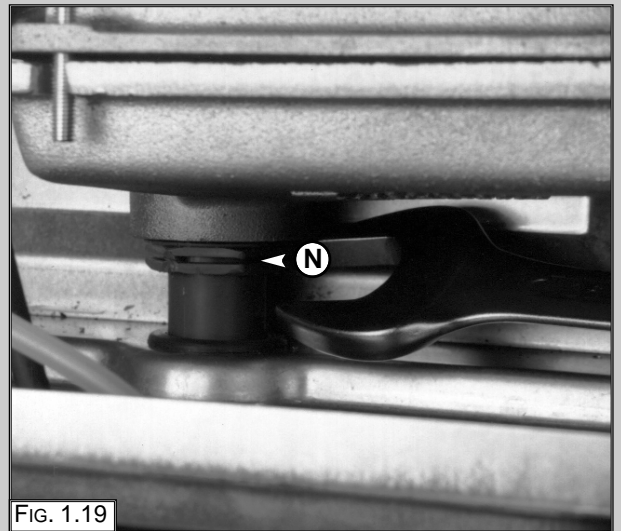
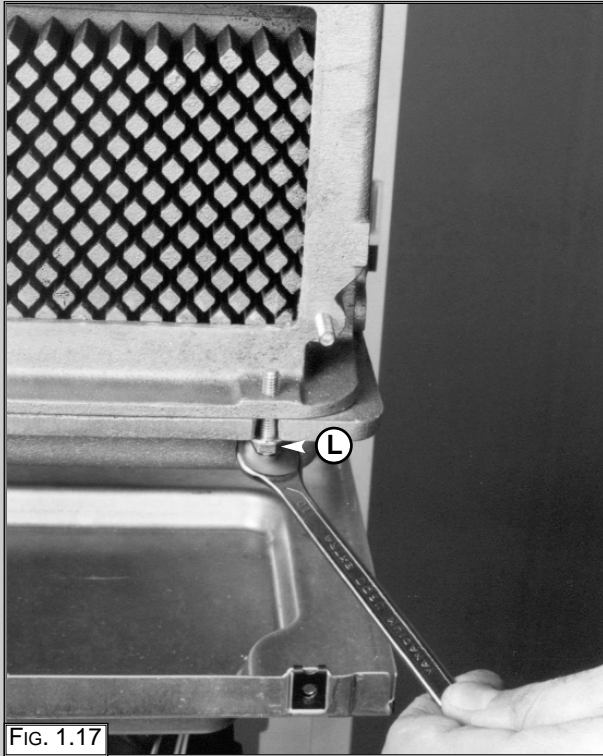

Removing the condensate trap

1. Loosen the union "O" (FIG. 1.22);
2. Remove the condensate trap (FIG. 1.23).

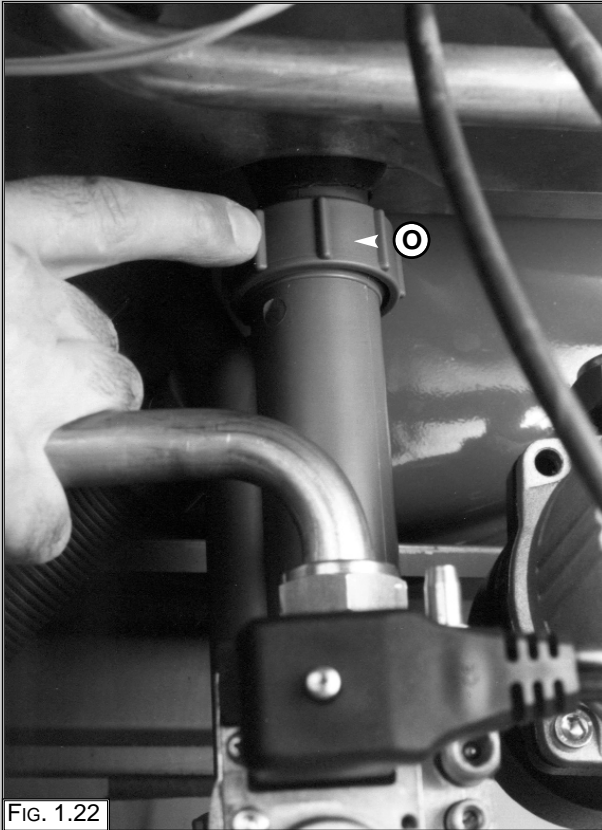

Removing the injector

See the section on removing the fan before carrying out this procedure

1. Disconnect all connections from the fan and remove (FIG. 1.24);
2. Remove the four screws "P" (FIG. 1.25);
3. Unscrew the injector "Q" using a suitable screwdriver (FIG. 1.26);
4. Remove the injector (FIG. 1.27).

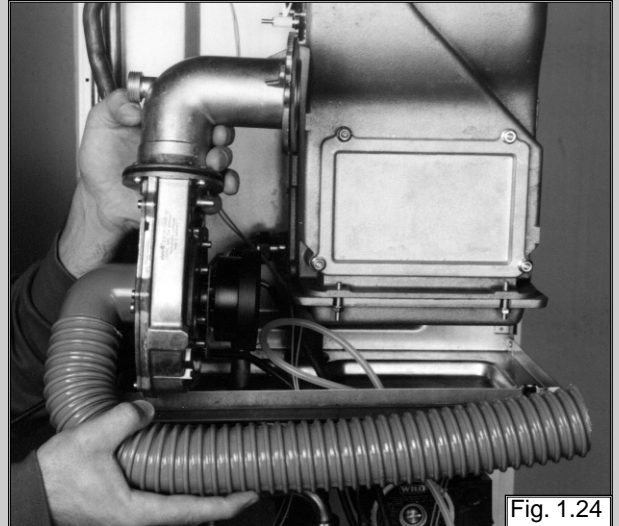

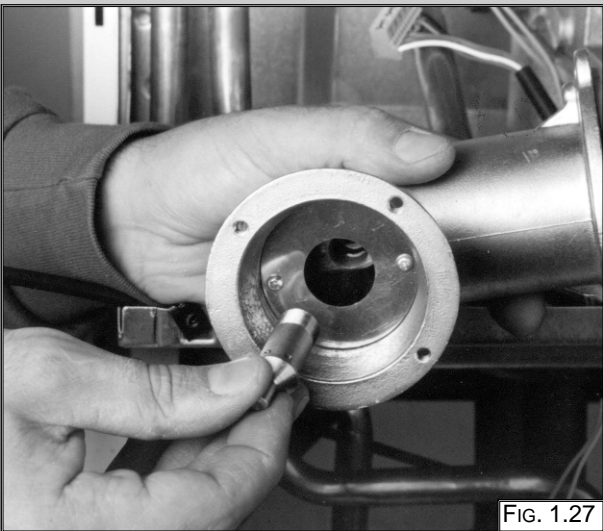
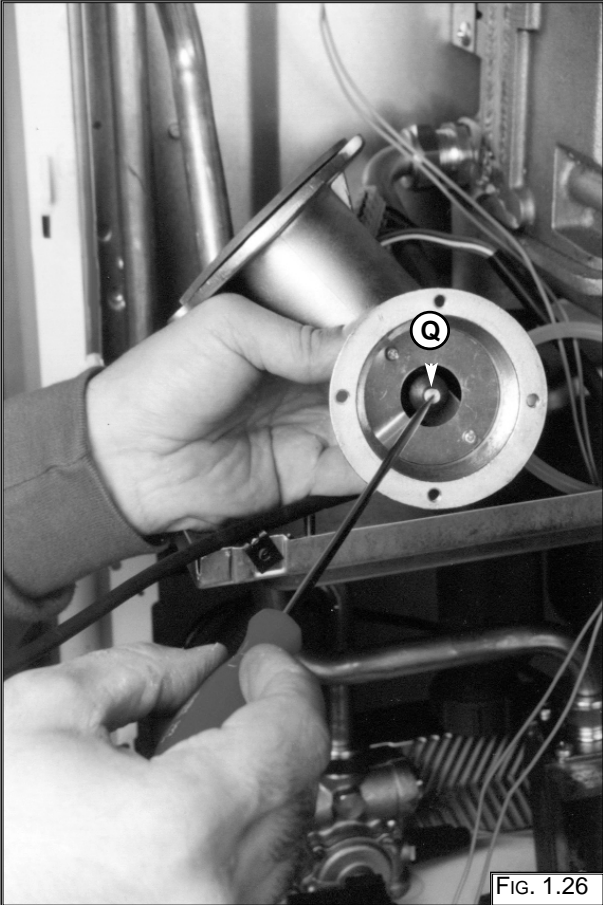

1.4 ACCESS TO THE GAS VALVE

Removing the gas valve

1. Disconnect the electrical connection "R" from the gas valve (FIG. 1.28);
2. Release the top nut "S" (FIG. 1.29);
3. Remove the screws "T" from the bottom of the gas valve pipe (FIG. 1.30);
4. Remove the gas valve (FIG. 1.31).

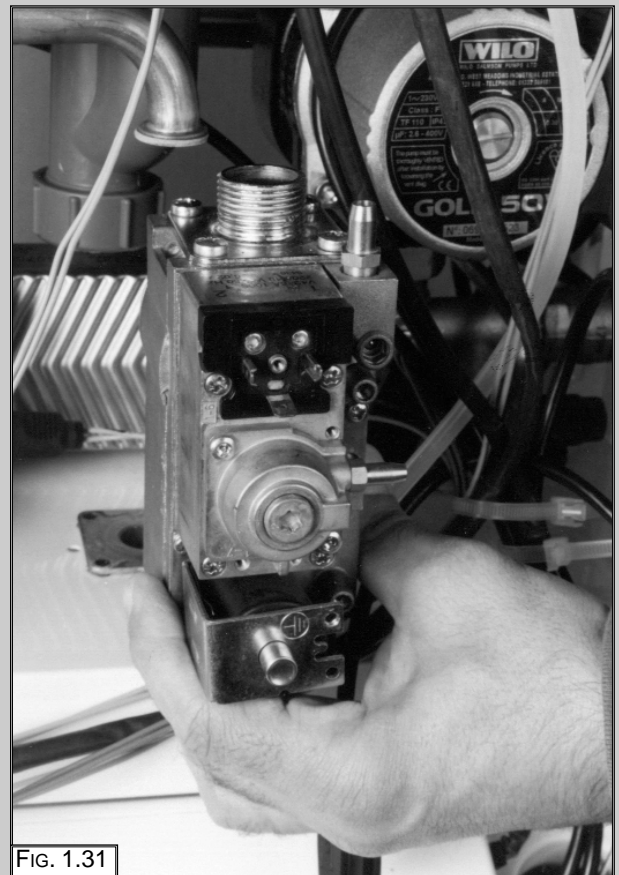
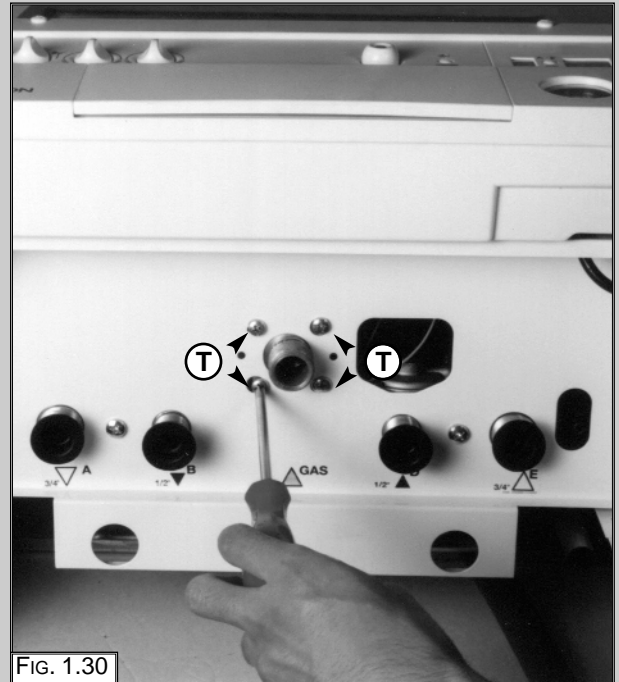
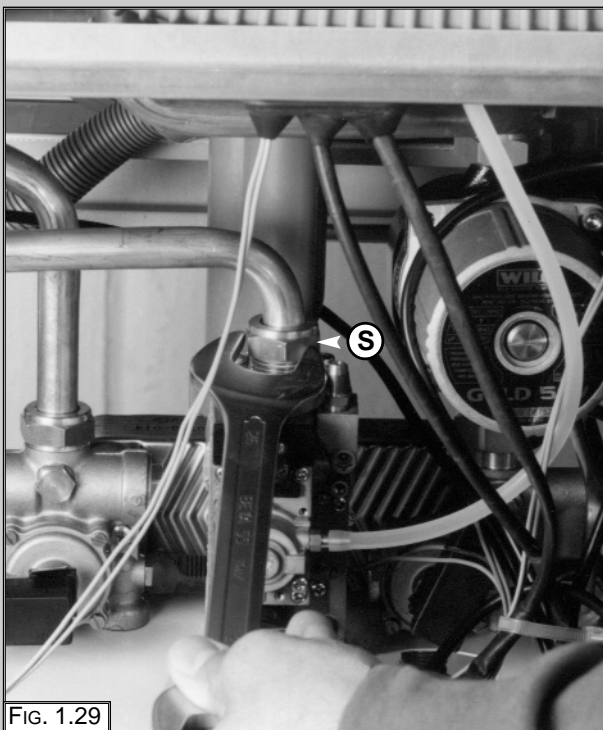
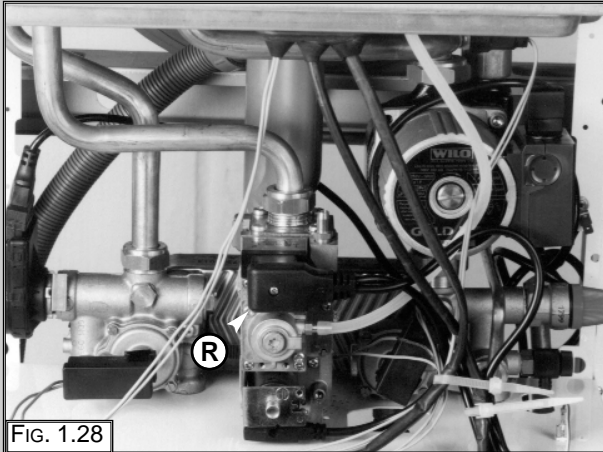

1.5 ACCESS TO THE WATER CIRCUIT

Important! Before any component is removed, the boiler must be drained of all water.

Removing the D.H.W. (secondary) exchanger

1. Remove the screw "U" (FIG. 1.32);
2. Remove the screw "V" (FIG. 1.33);
3. Push the exchanger towards the rear of the boiler, lift upwards and remove from the front of the boiler (FIG. 1.34);
4. Before replacing the exchanger ensure that the O-rings are in good condition and replace if necessary.

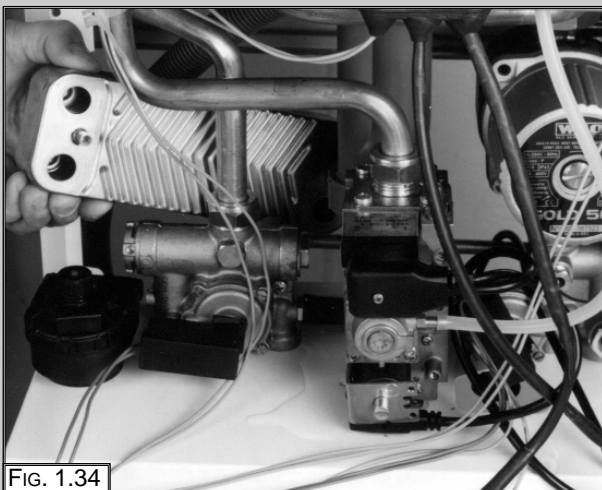
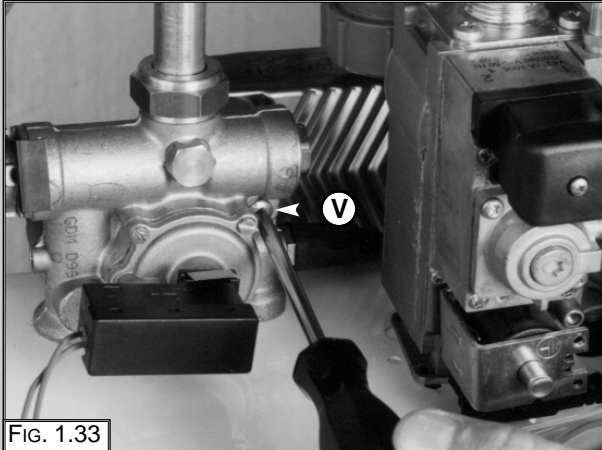
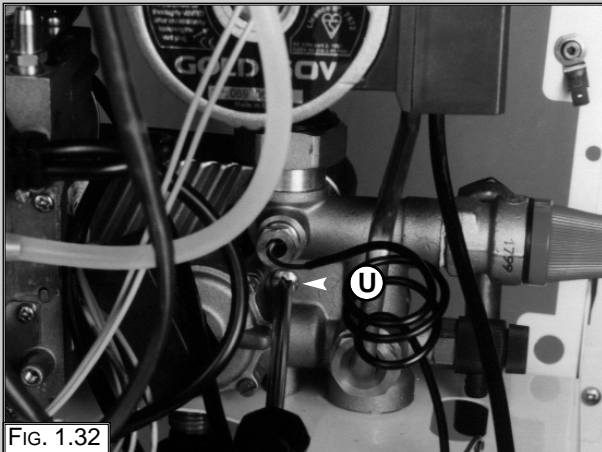

Removing the safety valve

1. Loosen union "W" (FIG. 1.35);
2. Unscrew and remove the valve (FIG. 1.36).

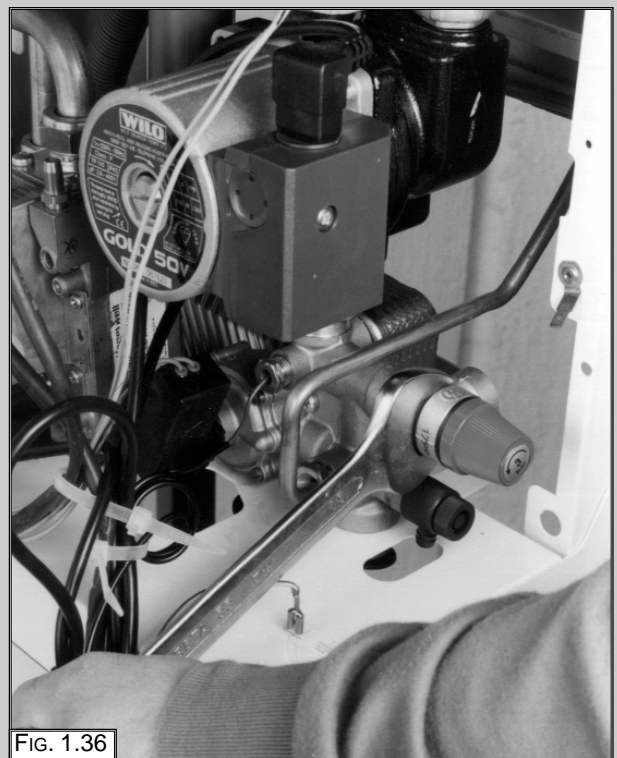
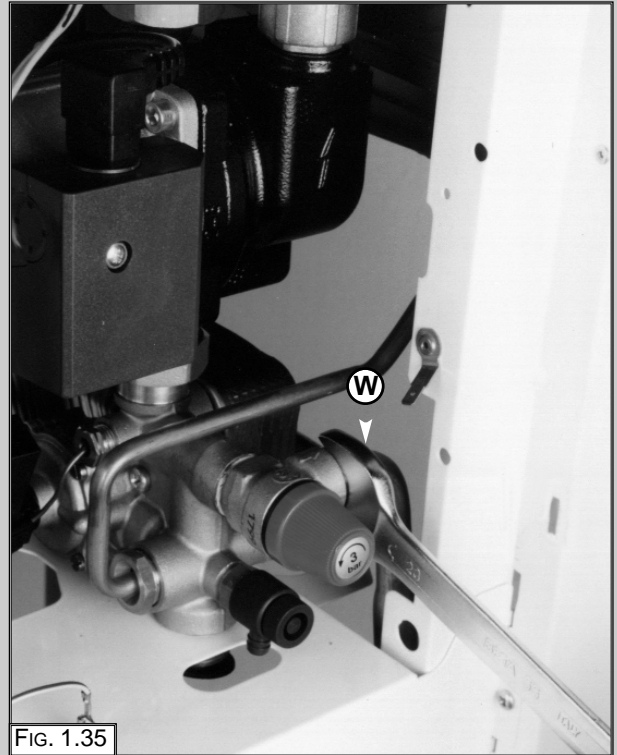

Removing the automatic air vent

1. Unscrew valve "X" (FIG. 1.37);
2. Remove (FIG. 1.38).

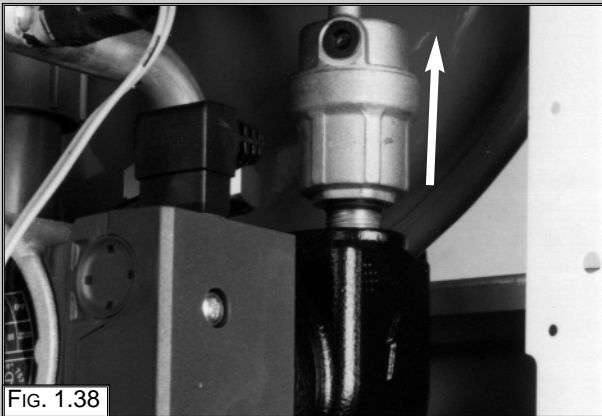
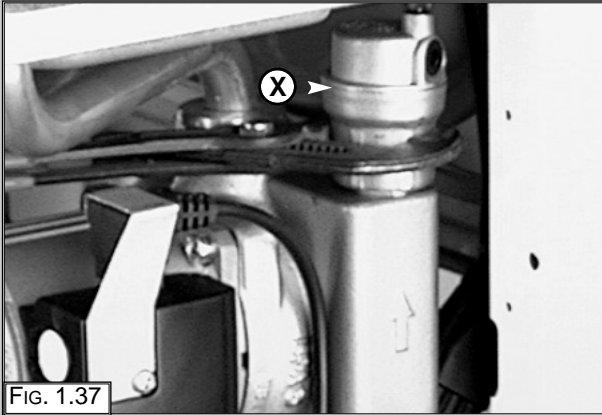

Removing the diverter valve actuator

1. Unplug the electrical connector "Z" (FIG. 1.41);
2. Release the retaining clip "A1" and remove the diverter valve actuator (FIG. 1.42).

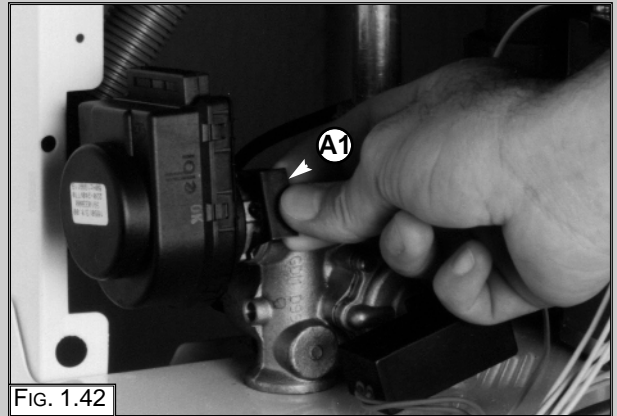
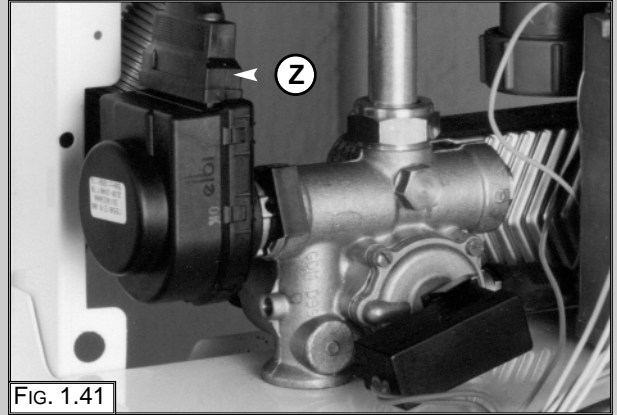

Removing the main circuit flow switch

1. Release the retaining clip "Y" (FIG. 1.40);
2. Remove the main circuit flow switch.

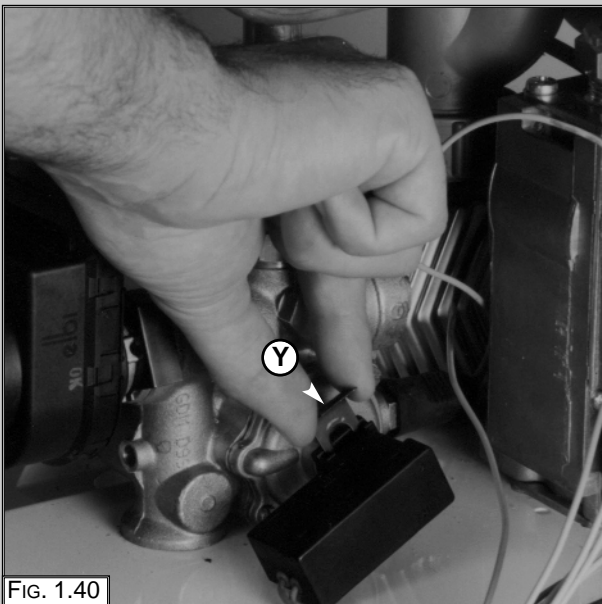

Removing the D.H.W. flow switch

1. Release the retaining clip "B1" (FIG. 1.43);
2. Remove the D.H.W. flow switch.

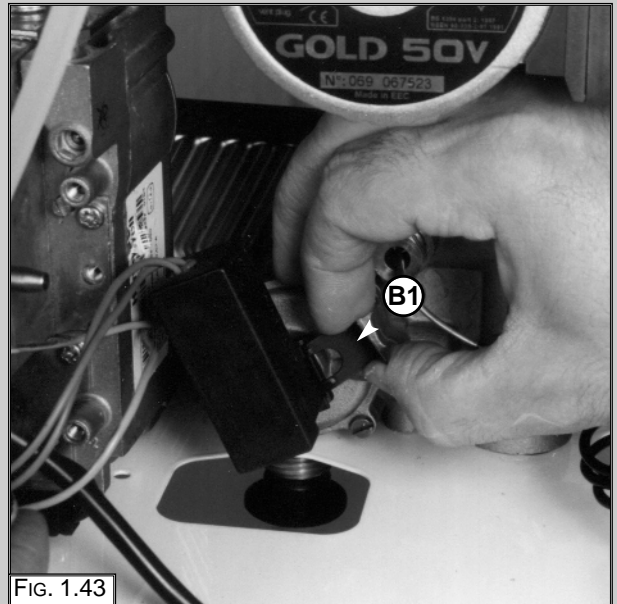

Removing the pump

1. Unplug the electrical connection "C1" (FIG. 1.44);
2. Release the nut "D1" (FIG. 1.45);
3. Release the nut "E1" (FIG. 1.46);
4. Remove the pump (FIG. 1.47).



FIG. 1.44



FIG. 1.45

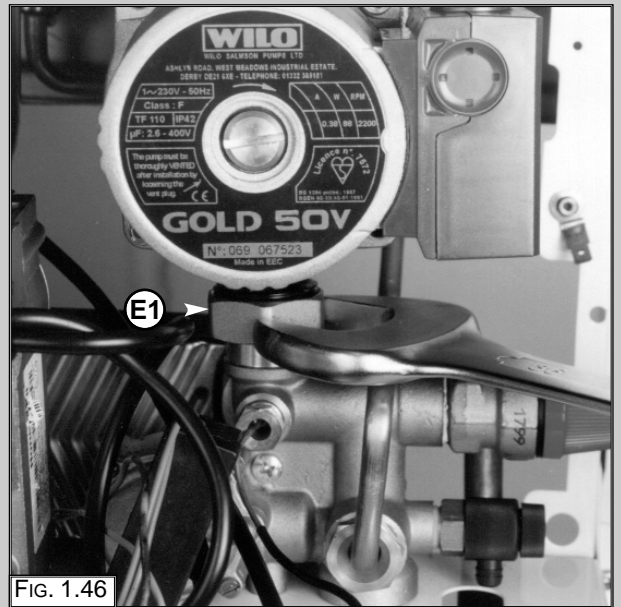

FIG. 1.46

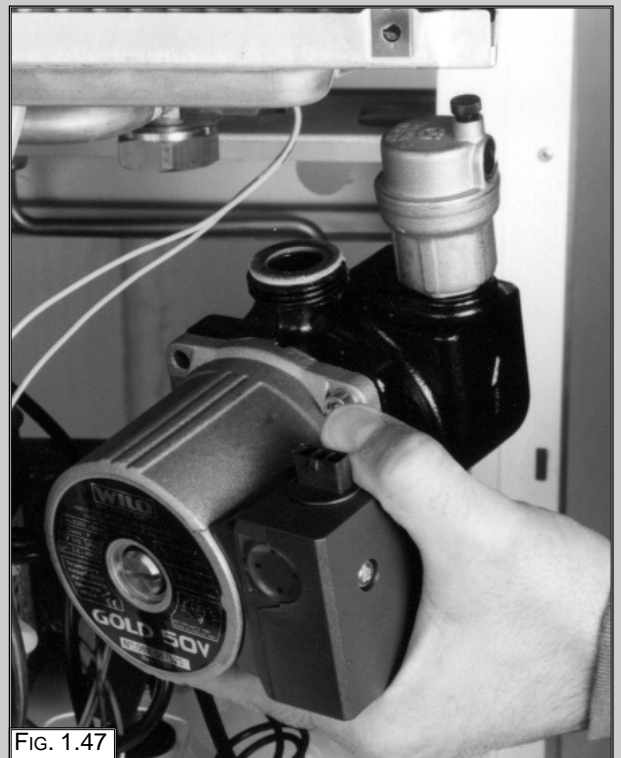

FIG. 1.47

Removing the pressure gauge

1. Release coupling "F1" (FIG. 1.48);
2. Ease the pressure gauge "G1" through the control panel from the rear (FIG. 1.49);
3. Remove the pressure gauge. (FIG 1.50).

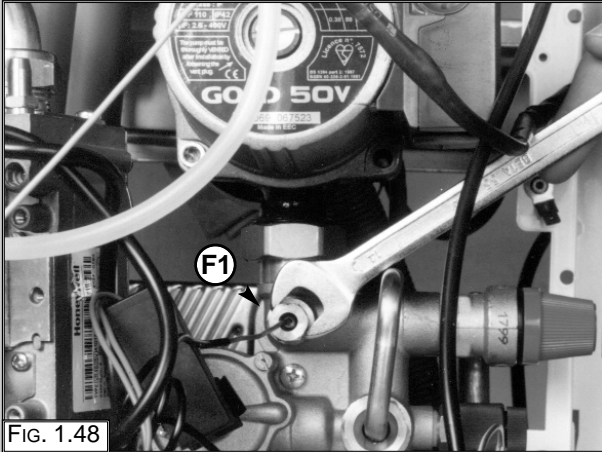

FIG. 1.48

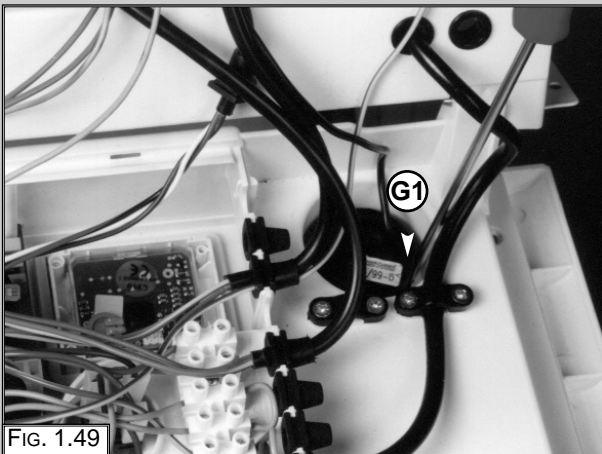

FIG. 1.49

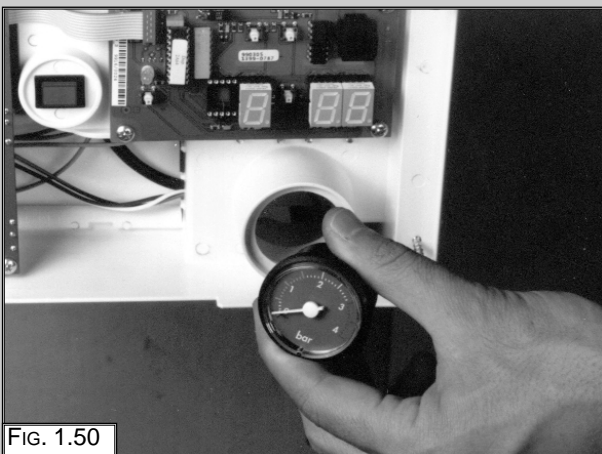

FIG. 1.50

Removing the expansion vessel

See the section on removing the condensate trap before carrying out this procedure

1. Loosen nut "H1" (FIG. 1.51);
2. Loosen nut "I1" and remove backnut "J1" (FIG. 1.52);
3. Remove the expansion vessel (FIG. 1.53).

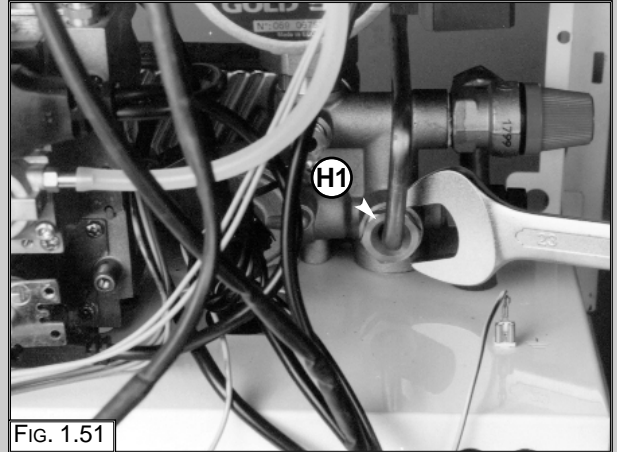

FIG. 1.51

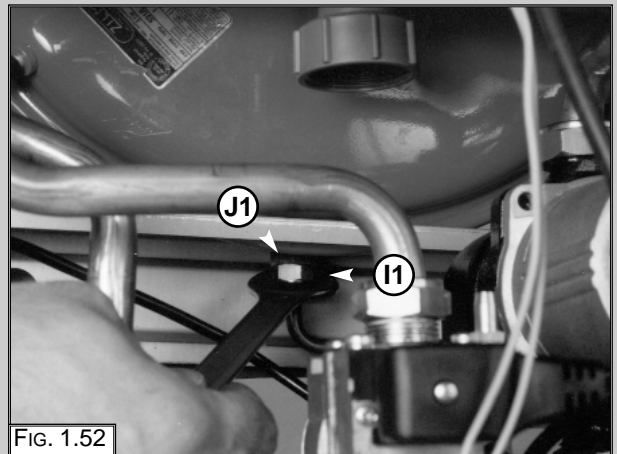

FIG. 1.52

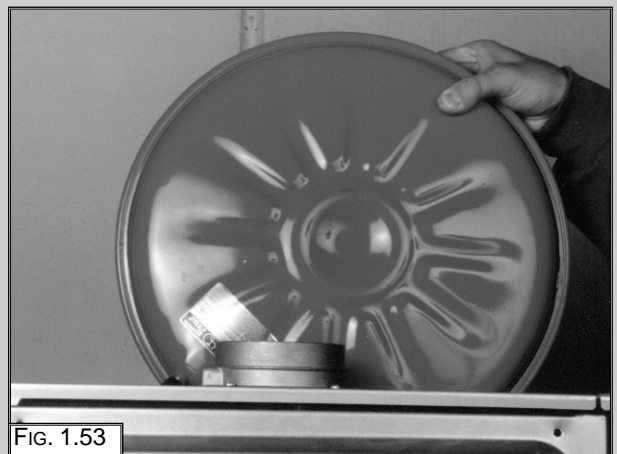

FIG. 1.53

Removing the D.H.W. temperature probe (N.T.C.) (MFFI only)

1. Remove the electrical connector "K1" by pulling off (Fig. 1.54);
2. Unscrew and remove the D.H.W. temperature probe "L1" (Fig. 1.55).

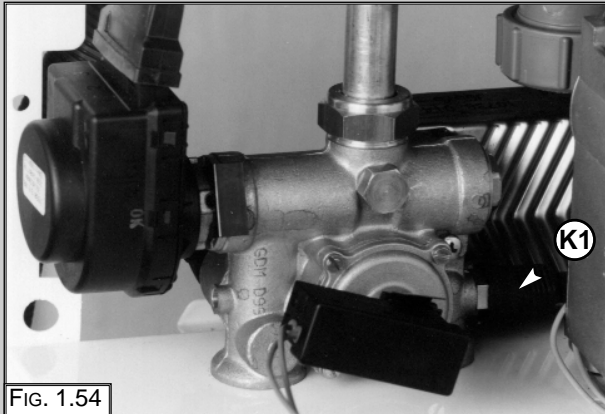

FIG. 1.54

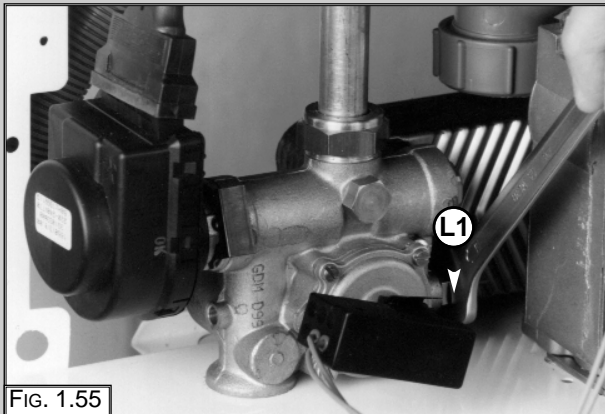

FIG. 1.55

Removing the C.H. flow temperature probe (N.T.C.)

1. Remove the electrical connector "M1" by pulling off (Fig. 1.56);
2. Unscrew and remove the C.H. flow temperature probe "N1" (Fig. 1.57).

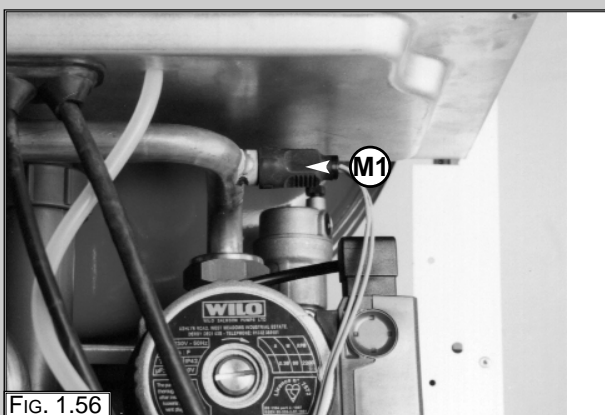

FIG. 1.56

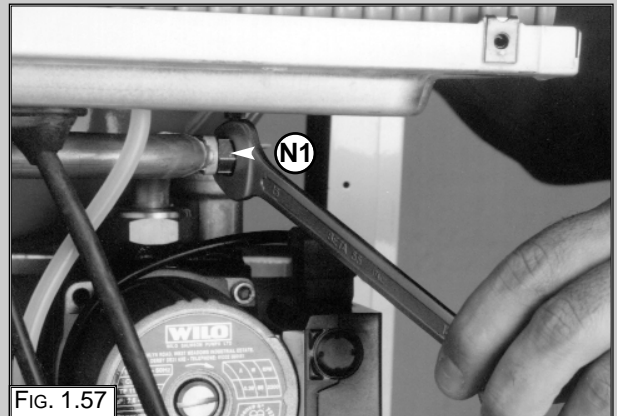

FIG. 1.57

Removing the C.H. return temperature probe (N.T.C.)

1. Remove the electrical connector "O1" by pulling off (Fig. 1.58);
2. Unscrew and remove the C.H. return temperature probe "P1" (Fig. 1.59).

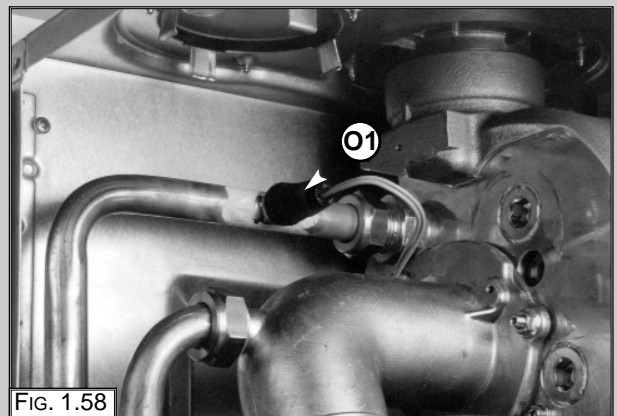

FIG. 1.58

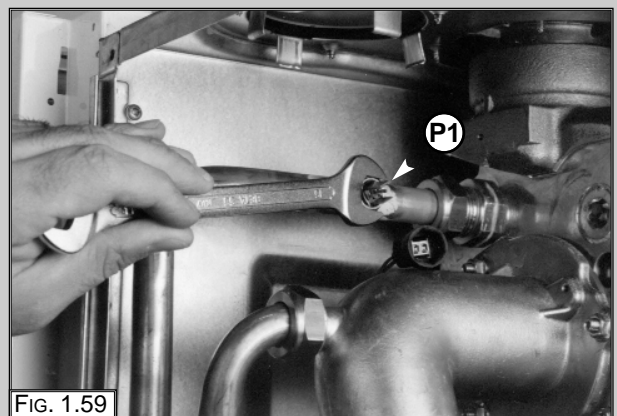
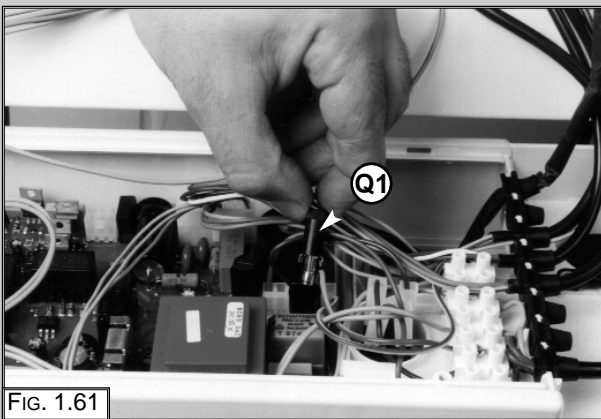
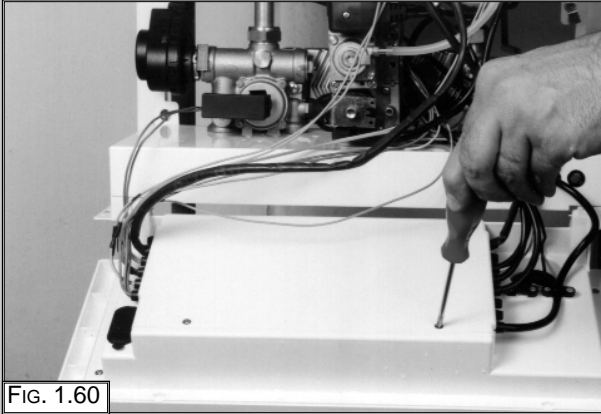

FIG. 1.59

1.6 ACCESS TO THE CONTROL SYSTEM

Checking the fuses

1. Remove the inspection cover on the reverse of the control panel (FIG. 1.60);
2. Remove the fuses by pushing and rotating fuse holders "Q1" (FIG. 1.61).



Removing the time clock

1. Remove the inspection cover on the reverse of the control panel (FIG. 1.60);
2. Lower the time clock door (FIG. 1.62);
3. Unplug the electrical connection "R1" from the time clock (FIG. 1.63);
4. Gently squeeze each end of the time clock and push through the control panel (FIG. 1.64).

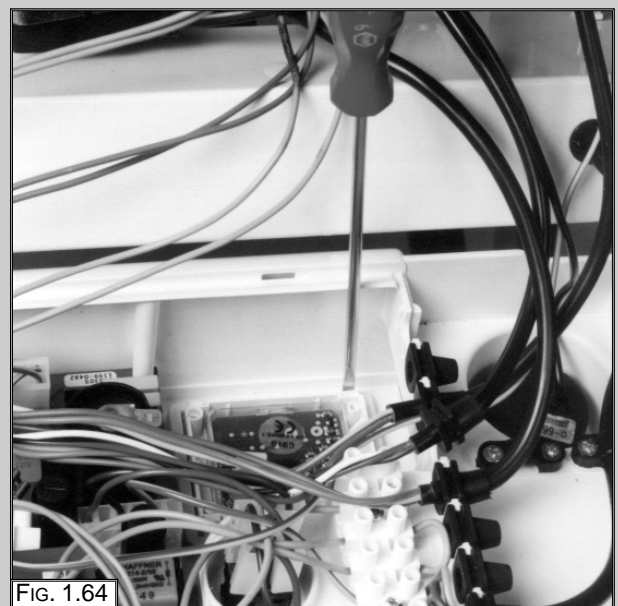
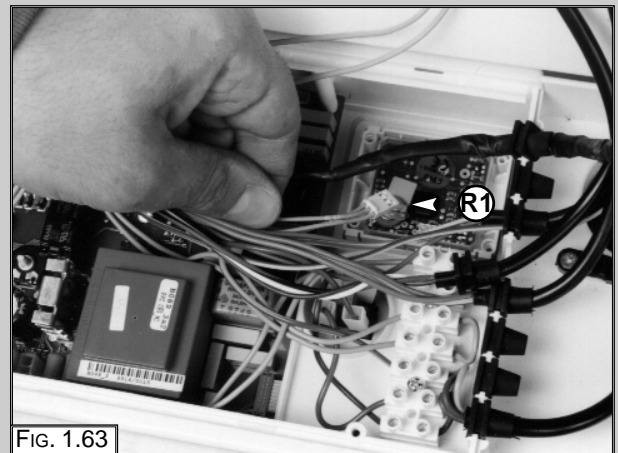

Removing the P.C.B.s

1. Remove the inspection cover on the reverse of the control panel (FIG. 1.60);
2. Remove the screws "S1" (FIG. 1.65 & FIG. 1.66);
3. Remove the fascia panel (FIG. 1.67);
5. Disconnect the connection cable "T1" (FIG. 1.68);
6. Unplug the electrical connectors "U1" from the main P.C.B. (FIG. 1.69);
7. Remove the main P.C.B. mounting screws "V1" (four in total) (FIG. 1.70);
8. Remove the main P.C.B. (FIG. 1.71);
9. Remove the display P.C.B. mounting screws "W1" (FIG. 1.72);
10. Remove the display P.C.B. (FIG. 1.73);
11. Replace either P.C.B. in reverse order.

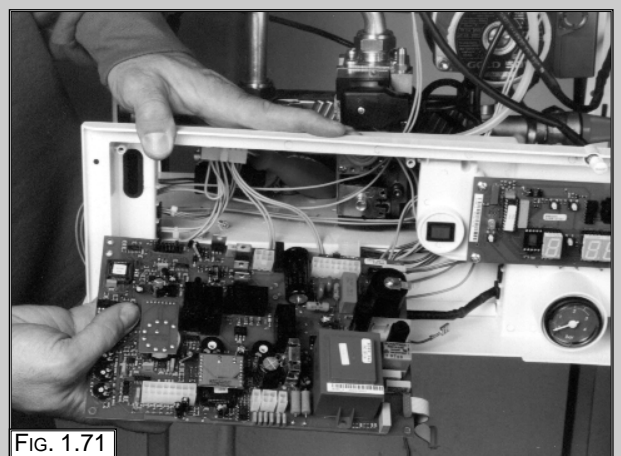
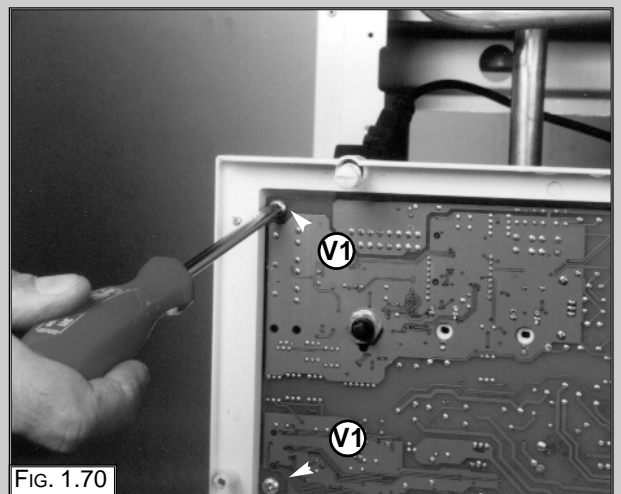
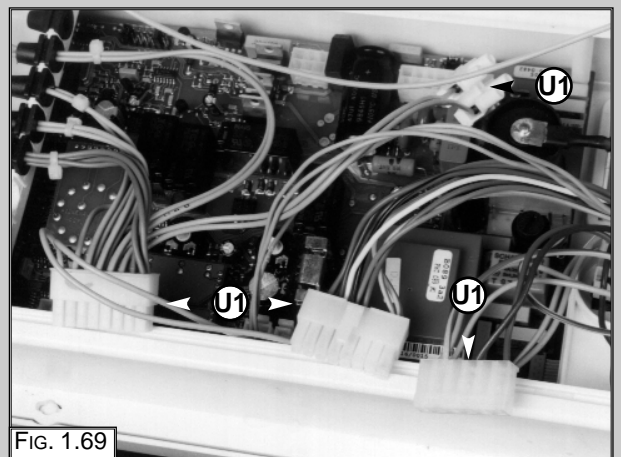
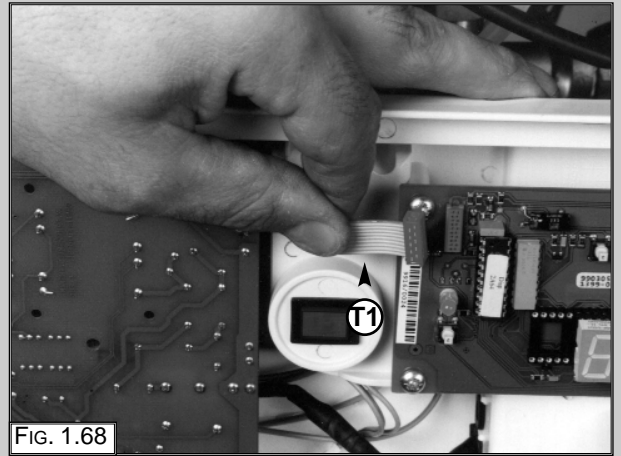
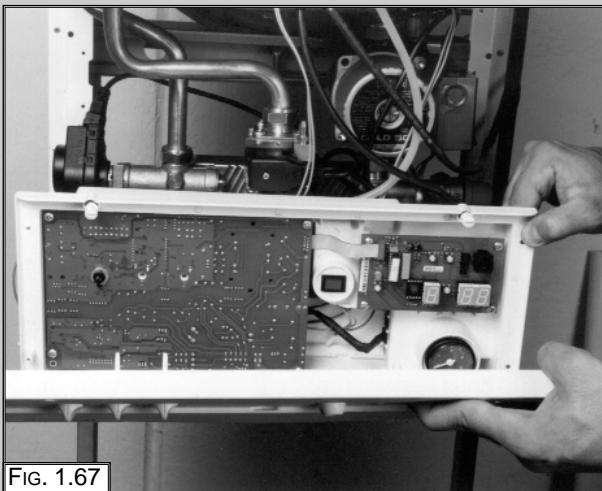
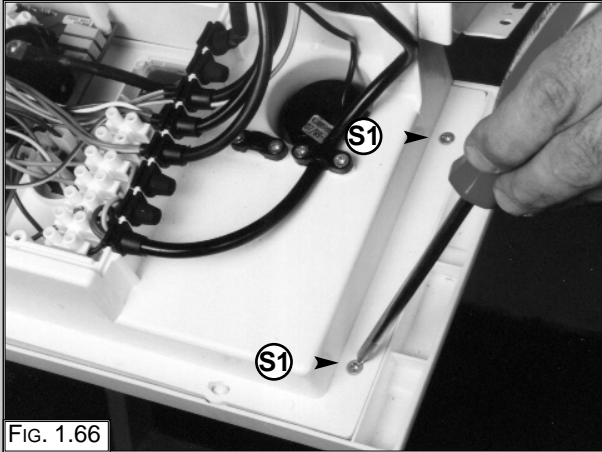
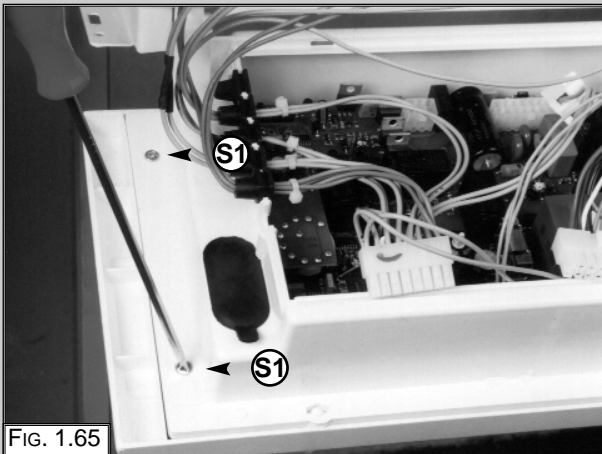

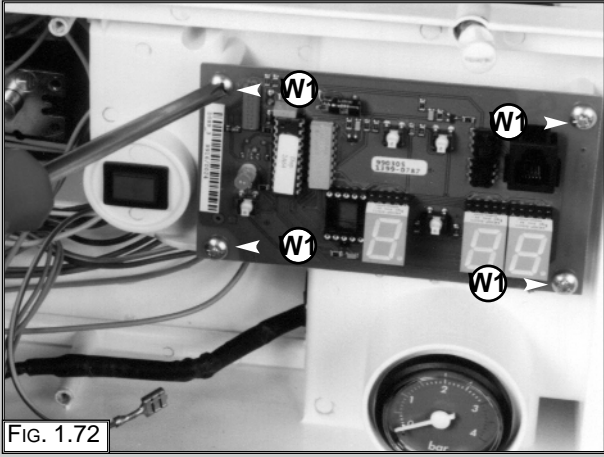

FIG. 1.72

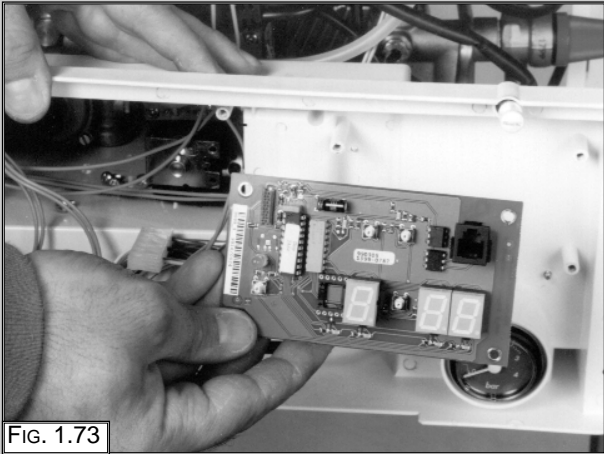

FIG. 1.73

2. FAULT FINDING

2.1 FAULT FINDING GUIDE (FLOW-CHARTS)

It is possible to detect and correct any defect by using the standard fault finding diagrams described in this chapter.

Model 24 MFFI

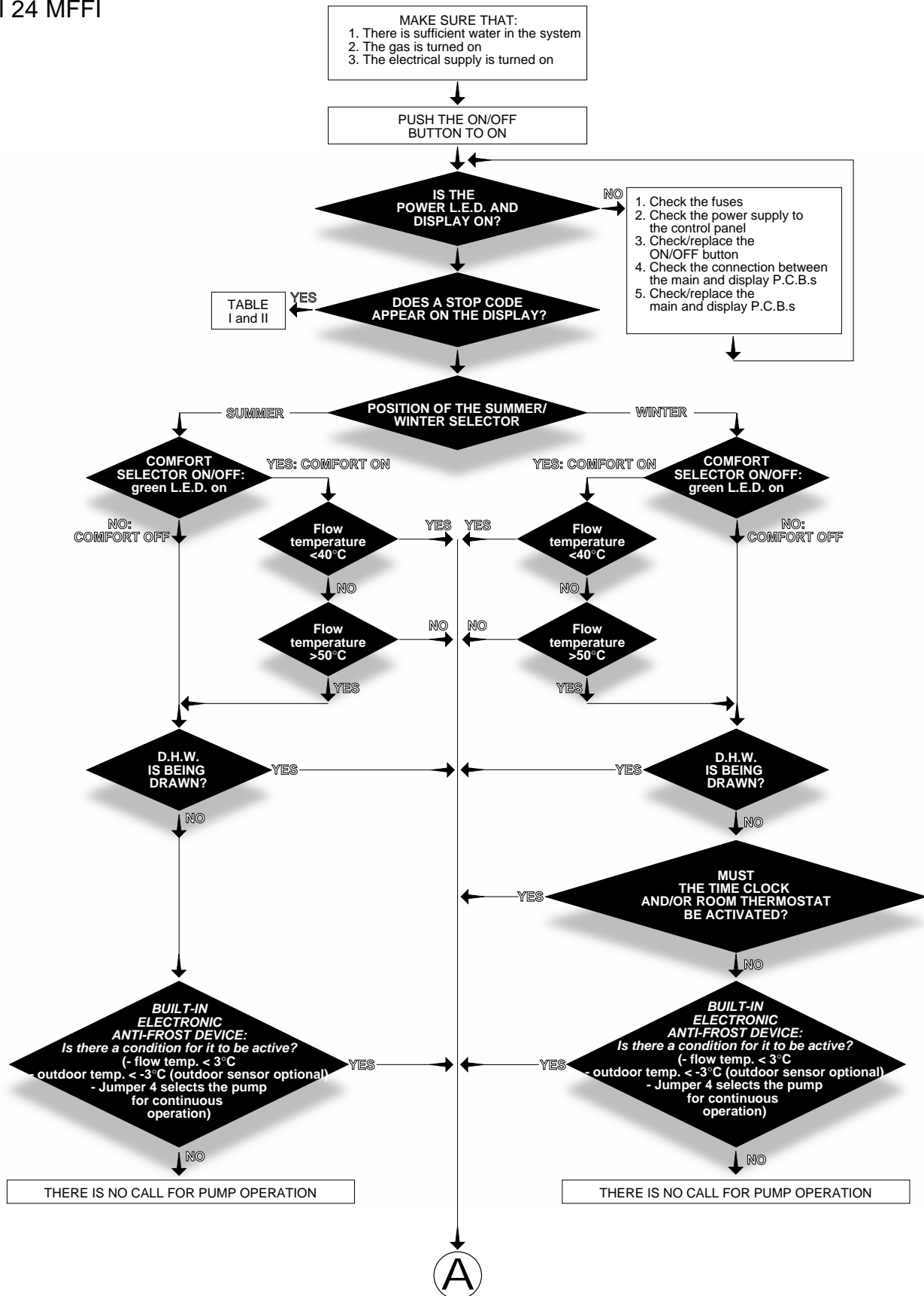

Model 24 RFFI System

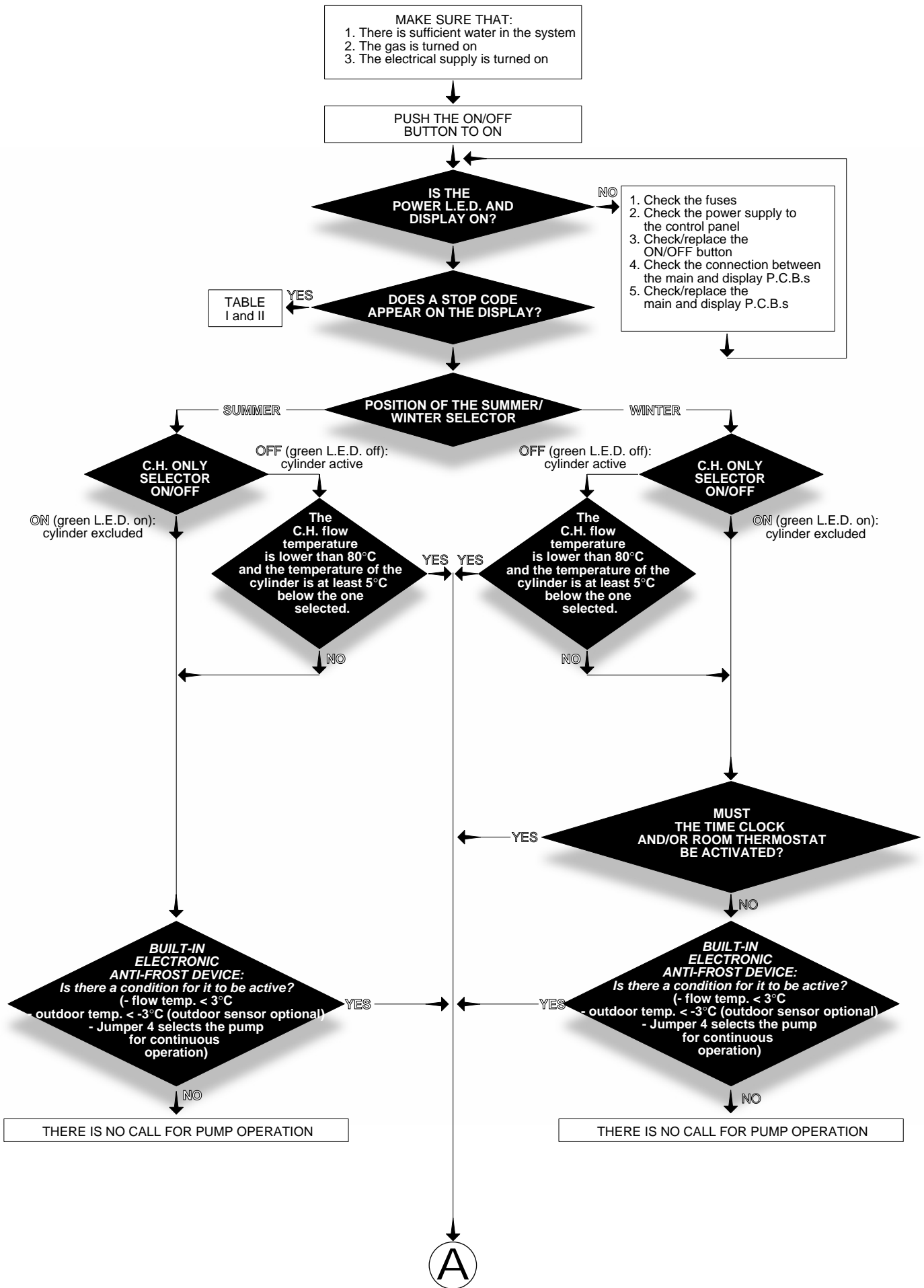

Model 24 MFFI/24RFFI System

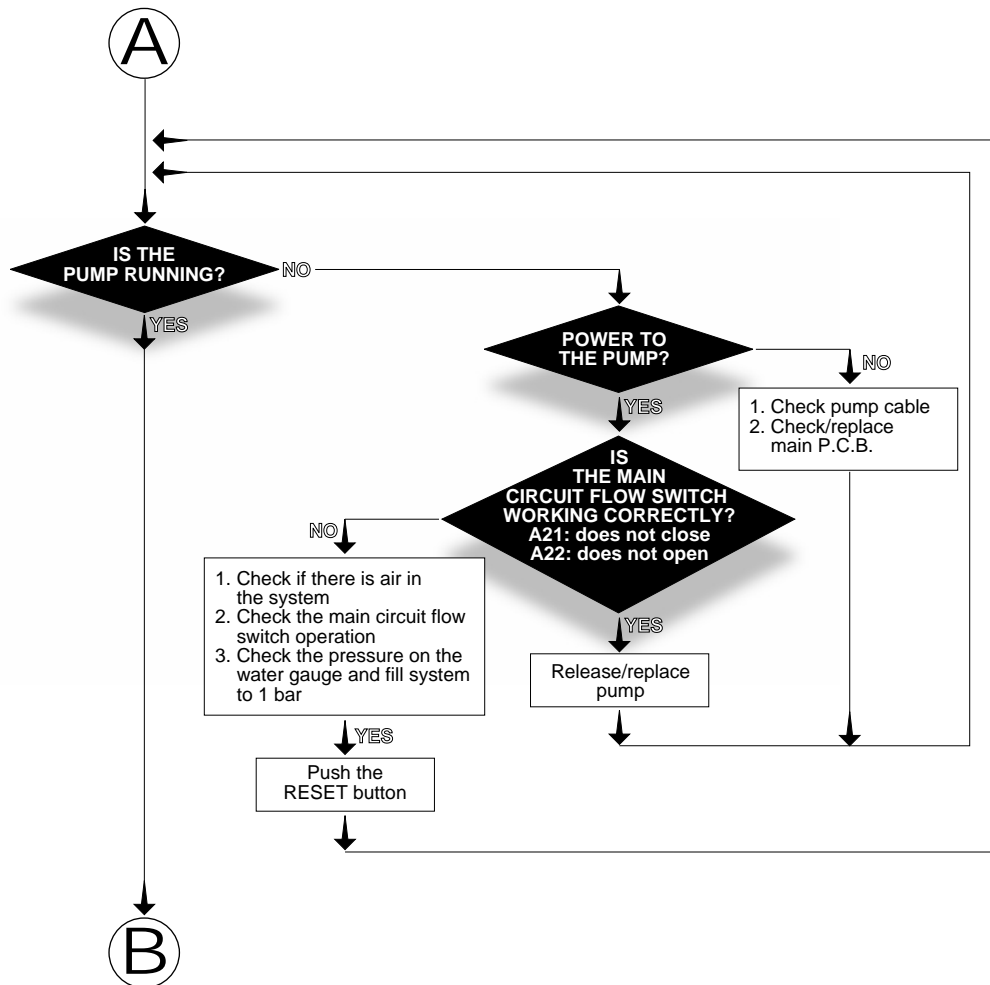

Model 24 MFFI/24RFFI System

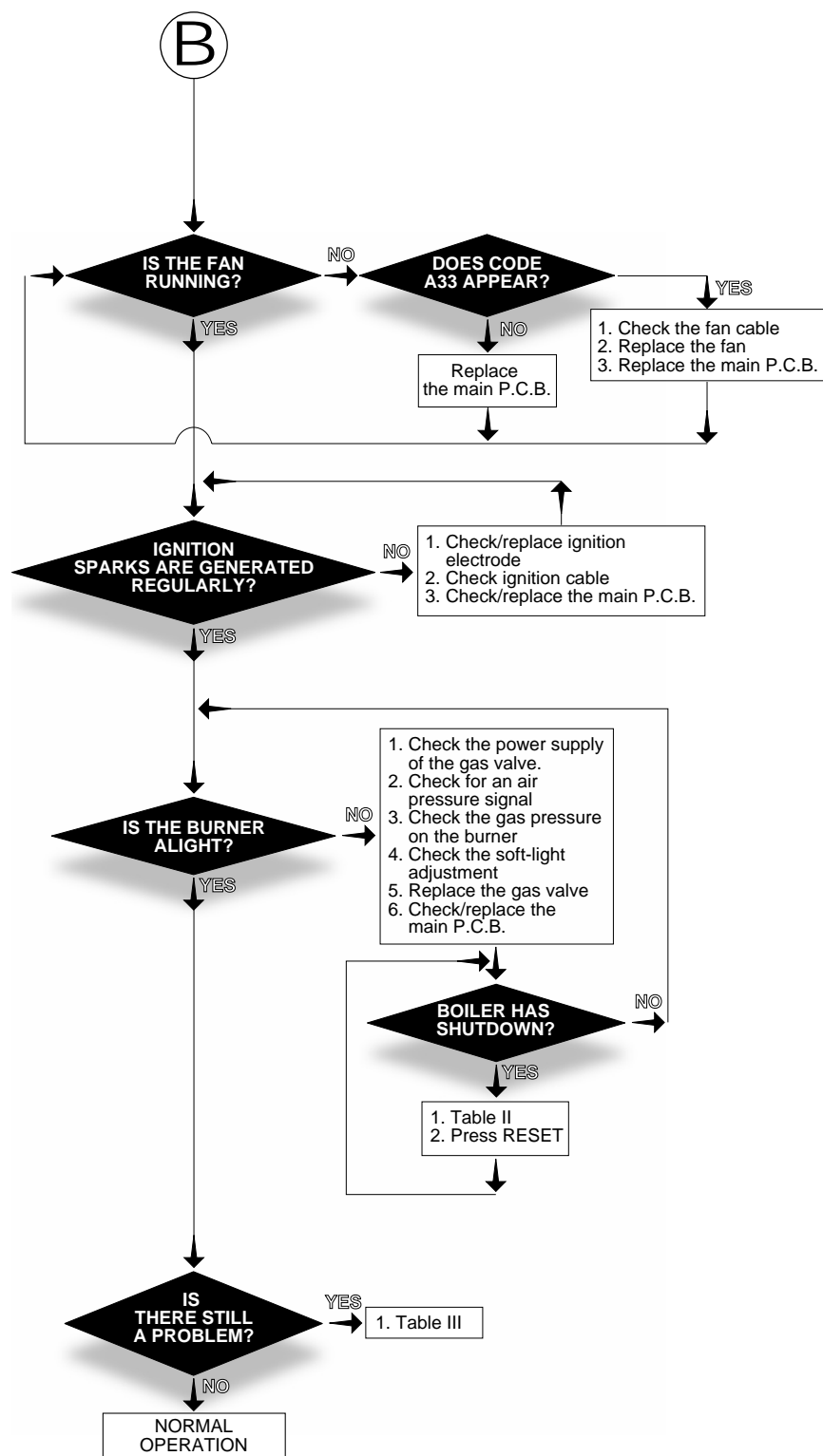

TABLE I	
DISPLAY	CAUSE
A01	Too many attempts to ignite on starting up
A02	After three attempts at ignition, no increase in ΔT was detected
A03	The heating flow temperature exceeds 100°C during operation
A07	Too many failures to flame in one period during operation
A19	The flame was detected after the gas valve had closed
A20	The flame was detected before the gas valve opened
A21	The flow switch does not close
A22	The flow switch does not open
A33	Problem with the fan
A99	Problem with the electronic monitoring

TABLE II	
DISPLAY	CAUSE
E03	Flow temperature over 100°C while boiler is not in operation (stand-by)
E5b	Heating flow temperature probe in open circuit
E6b	Heating flow temperature probe
E04	Domestic hot water temperature probe in open circuit
E05	Domestic hot water temperature probe in short circuit
E08	Under floor heating temperature probe in open circuit
E20	Flame detected with gas valve closed
E21	Error in the electrical connection (live and neutral crossed)
E22	Problem with the 50Hz power supply
E23	Flame detection electrode short-circuited
E64	Heating return temperature probe in open circuit
E74	Heating return temperature probe in short circuit
E99	Problem within the electronic system

TABLE III	
FAULTS	POSSIBLE CAUSES
1. Drawing D.H.W: Radiators heat up in summer mode	- faulty 3-way valve
2. Drawing D.H.W: Insufficient hot water temperature	- check C.H./D.H.W. temperature probes - check gas pressures - check water flow rate - check secondary heat exchanger
3. Drawing D.H.W: Noisy operation	- primary heat exchanger faulty or lime-scale deposits - low heating system water pressure - check gas pressures - check C.H./D.H.W. temperature probes
4. Decrease/increase heating circuit pressure	- check for leaks on the heating circuit - faulty filling-loop - faulty secondary heat exchanger - expansion vessel faulty
5. When cold water tap turned off, the boiler ignites	- drop in pressure in the water mains, with consequent water hammer
6. Insufficient radiator temperature	- check C.H. temperature probe - check by-pass - check gas pressures

3. ELECTRICAL DIAGRAMS

LEGEND:

A: JUMPER

When needed, the P.C.B. allows the different options to be selected by means of a wire link.

The boiler has the following basic arrangement:

- 1 OPEN
- 2 CLOSED (*jumper*)
- 3 OPEN
- 4 OPEN
- 5 OPEN
- 6 OPEN
- 7 CLOSED
- 8 OPEN (*MFFI*); CLOSED (*SYSTEM*)

NOTE: under absolutely no circumstances must jumpers 2, 7 and 8 be removed. The opening of such contacts will lead to boiler malfunction.

This is the factory configuration. It is recommended that this set-up not be changed, unless under the following particular circumstances:

JUMPER 3: if the contact is closed, the Secondary Output (flying clamp connected to connection C7; positions 1-9) controls a LPG valve (optional).

JUMPER 4: if the contact is closed, the continuous operation of the pump is selected. If the contact remains open, it has no effect and there is no change in the operation of the boiler.

JUMPER 5: if the contact is closed, the signal transmitted by the connection of the secondary output clasp (connected to C7; positions 1-9) relates to a secondary pump (optional). If the contact remains open, the output signal controls a zone valve (optional).

JUMPER 6: not used

JUMPER 7/8:

7	8	CONFIGURATION
N.I.	N.I.	Central heating only
I.	N.I.	MFFI
N.I.	I.	Not used
I.	I.	RFFI System

I = inserted (contact closed)
N.I = not inserted (contact open)

NOTE: it is essential that the operations involving setting of the jumpers be carried out only with the device turned off.

B: Control microprocessor

C: Flame detection jumper (under no circumstances should this jumper be moved from the 1-2 position)

D: Anti-cycling device (RA)

E: Maximum heating output regulation (PR)

F: Soft-light regulation (RLA)

G: Operating mode selector knob

H: Heating temperature adjustment

I: Domestic hot water temperature adjustment

J: Remote control module

K: Main microprocessor

L: Relay

M: Fuses (2 x 0.54 A SLOW)

N: Transformer (PRI: 230V-50Hz; SEK: 10V-0,8VA; SEK:10V-3,5VA; SEK:10V-3,5VA;)

O: Fuses (2 x 3.15 A SLOW)

P: Earth

Q: Spark generator

R: Connection to the main P.C.B.

S: Comfort light

T: Programming keys

U: Comfort key

V: Alpha-numeric display

X: Set and reset key

W: Connection to PC

C1 = FAN

- 1: "Hall" sensor power supply 12V (red)
- 2: "Hall" sensor ground (blue)
- 3: Not used
- 4: Start of coil (black)
- 5: "Hall" sensor input (white)
- 6: End of coil (brown)

C2 = POWER SUPPLY

- 1: Earth (yellow/green)
- 2: Earth (yellow/green)
- 3: Not connected
- 4: Neutral (blue)
- 5: Not connected
- 6: Live (brown)

C3 = CONNECTION TO ROOMSTAT

- 1: Input - 1
- 2: Input - 2

C4 = TIMER

- 1: 3 V output
- 2: Timer ground
- 3: Timer output
- 4: Not connected

C5 = REMOTE CONTROL (Bus+/Bus-)

- 1: Input/output-1
- 2: Input/output-2

C6 = SENSOR CONNECTOR

- 1: Domestic hot water flow switch (grey)
- 2: Main circuit flow switch (grey)
- 3: Under floor heating thermostat (grey)
- 4: Heating flow sensor (grey)
- 5: Heating return sensor (grey)
- 6: Domestic hot water sensor (grey)
- 7: Not used: jumper
- 8: Outdoor sensor (grey)
- 9: Domestic hot water flow switch (grey)
- 10: Main circuit flow switch (grey)
- 11: Under floor heating thermostat (grey)
- 12: Flow sensor (grey)
- 13: Heating sensor (grey)
- 14: Domestic hot water sensor (grey)
- 15: Not used: under floor heating
- 16: Outdoor sensor (grey)

C7 = EQUIPMENT CONNECTIONS

- 1: Secondary output (optional)
- 2: Gas valve (white)
- 3: 3-way valve neutral (white)
- 4: Pump (white)
- 5: Ionisation (black)
- 6: Not connected
- 7: Ground
- 8: Pump earth (yellow/green)
- 9: Secondary output (optional)
- 10: Gas valve (brown)
- 11: 3-way valve (domestic hot water) (brown)
- 12: 3-way valve (heating) (brown)
- 13: Pump (brown)
- 14: Not connected
- 15: Earth
- 16: Gas valve earth (yellow/green)

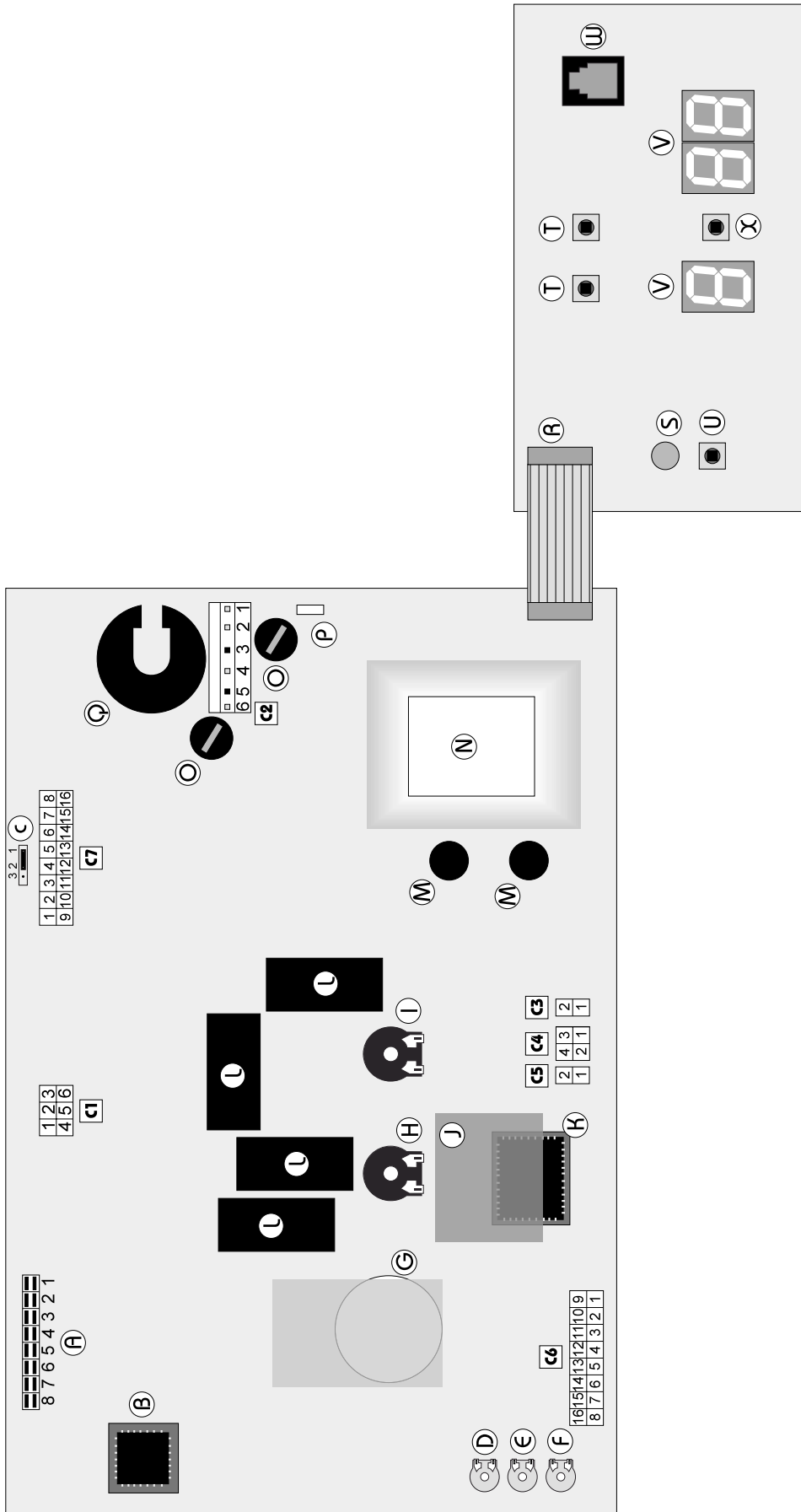

4. SHORT SPARE PARTS LIST

ecoGENUS - 24 MFFI

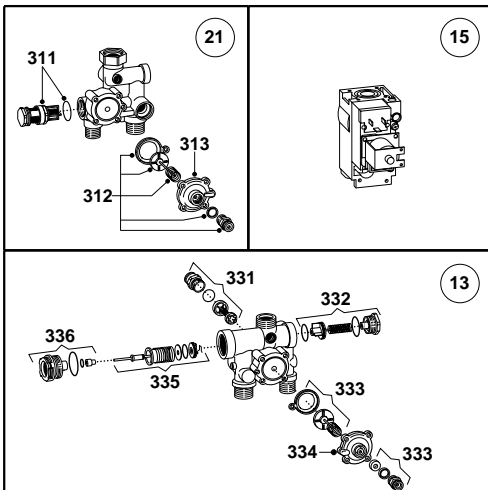
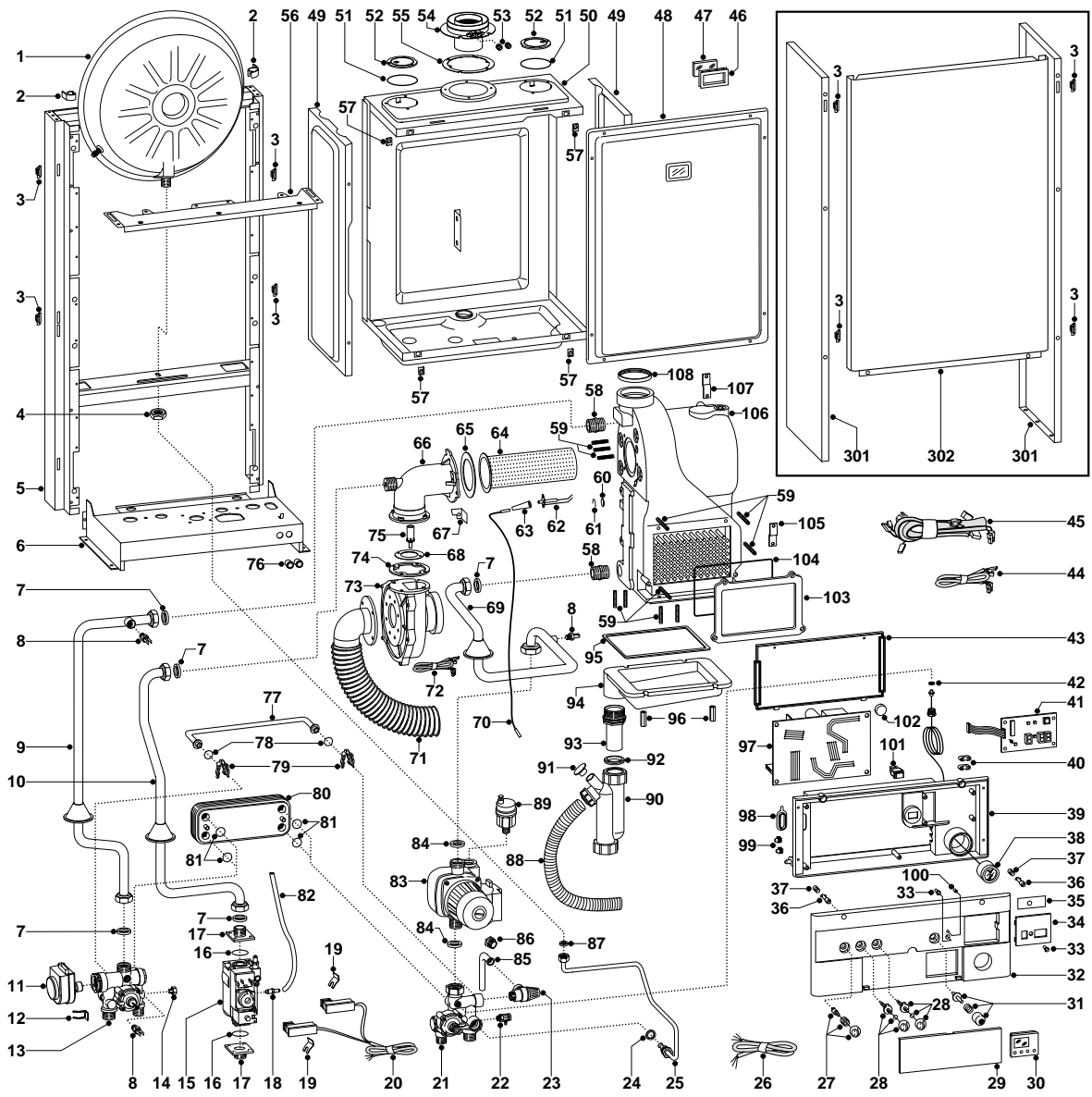

ecoGENUS - 24 RFFI SYSTEM

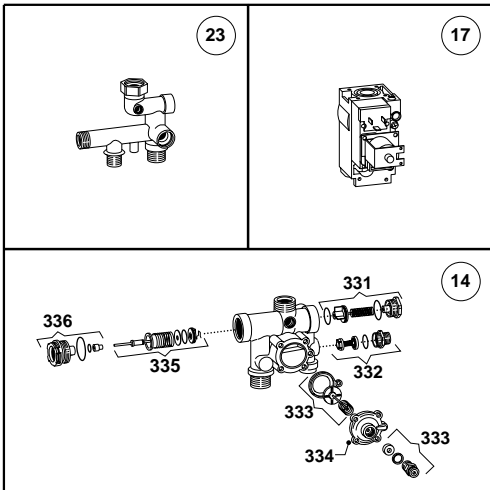
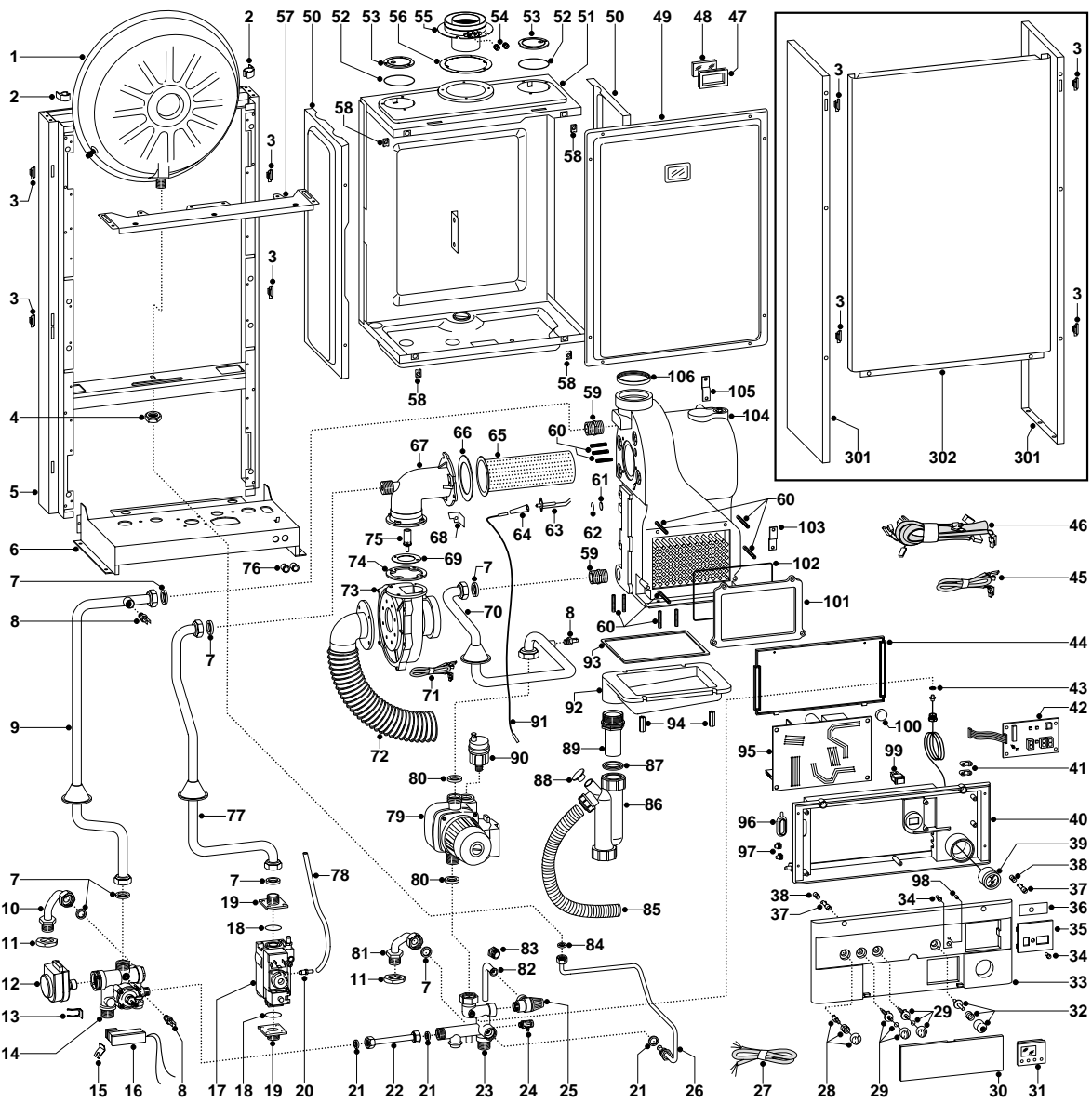

Manufacturer: **Merloni TermoSanitari SpA - Italy**

Commercial subsidiary: **MTS (GB) LIMITED**

MTS Building
Hughenden Avenue
High Wycombe
Bucks HP13 5FT

Telephone: (01494) 755600

Fax: (01494) 459775

Internet: <http://www.mtsgb.ltd.uk>

E-mail: info@mtsgb.ltd.uk

Technical Service Hot Line: (01494) 539579