

Standard Range

Models 24/39, 32/40, 40/61, 63/62 and 84/87

NB. Service clearance G can be reduced to 300 mm if Correx Anodes are fitted.



0063

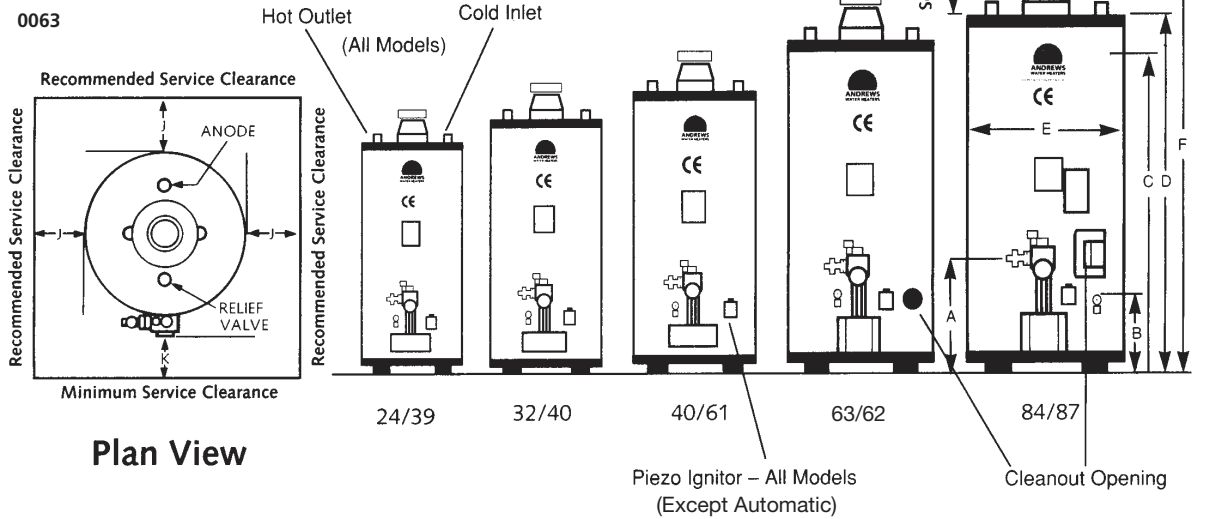

Plan View

Andrews Model No.	24/39		32/40		40/61		63/62		84/87	
	SI METRIC	IMPERIAL	SI METRIC	IMPERIAL	SI METRIC	IMPERIAL	SI METRIC	IMPERIAL	SI METRIC	IMPERIAL
A Gas Connection	350 mm	13 3/4 in	350 mm	13 3/4 in	350 mm	13 3/4 in	409 mm	16 1/8 in	401 mm	15 3/4 in
B Drain Cock	227 mm	9 in	227 mm	9 in	227 mm	9 in	288 mm	11 3/8 in	273 mm	10 3/4 in
C Relief Valve Port	-	-	-	-	-	-	-	-	1506 mm	59 1/2 in
D Height of Heater	1149 mm	45 1/4 in	1200 mm	47 1/4 in	1446 mm	56 7/8 in	1526 mm	60 in	1654 mm	65 in
E Diameter	457 mm	18 in	508 mm	20 in	508 mm	20 in	622 mm	24 1/2 in	718 mm	28 1/4 in
F Height to Flue	1276 mm	50 1/4 in	1327 mm	52 1/4 in	1589 mm	62 1/2 in	1669 mm	65 3/4 in	1788 mm	70 3/4 in
G Service Clearance (Top)	762 mm	30 in	762 mm	30 in	762 mm	30 in	1143 mm	45 in	1270 mm	50 in
H Nominal Flue Diameter	100 mm	4 in	100 mm	4 in	100 mm	4 in	125 mm	5 in	125 mm	5 in
I Connection Centres	203 mm	8 in	203 mm	8 in	203 mm	8 in	279 mm	11 in	406 mm	16 in
J Service Clearance (Sides & Rear)	305 mm	12 in	305 mm	12 in	305 mm	12 in	305 mm	12 in	305 mm	12 in
K Service Clearance (Front)	610 mm	24 in	610 mm	24 in	610 mm	24 in	610 mm	24 in	610 mm	24 in

Storage Capacity	109 lts	24 galls	145 lts	32 galls	182 lts	40 galls	286 lts	63 galls	382 lts	84 galls
Recovery thru 44°C/80°F	178 l/hr	39 gph	182 l/hr*	40 gph	278 l/hr	61 gph	281 l/hr	62 gph	397 l/hr	87 gph
56°C/100°F	142 l/hr*	31 gph	146 l/hr	32 gph	220 l/hr	49 gph	227 l/hr	50 gph	316 l/hr	70 gph
Heat Input	12.0 kW	40,944 Btu/hr	12.5 kW	42,650 Btu/hr	19.0 kW	65,000 Btu/hr	19.0 kW	65,000 Btu/hr	26.0 kW	88,712 Btu/hr
Gas Family	NATURAL	CAT I: H	NATURAL	CAT I: H	NATURAL	CAT I: H	NATURAL	CAT I: H	NATURAL	CAT I: H
Burner Gas Pressure	10.0 mbar	4.0 ins wg.	10.0 mbar	4.0 ins wg.	10.0 mbar	4.0 ins wg.	10.0 mbar	4.0 ins wg.	10.0 mbar	4.0 ins wg.
Max Gas Input Pressure	35.0 mbar	14.0 ins wg.	35.0 mbar	14.0 ins wg.	35.0 mbar	14.0 ins wg.	35.0 mbar	14.0 ins wg.	35.0 mbar	14.0 ins wg.
Gas Flow Rate	1.12 m³/h	39.54 ft³/h	1.16 m³/h	41.22 ft³/h	1.78 m³/h	62.86 ft³/h	1.78 m³/h	62.86 ft³/h	2.43 m³/h	85.71 ft³/h
Gas Connection	Rc 1/2	1/2 in BSP/Int	Rc 1/2	1/2 in BSP/Int	Rc 1/2	1/2 in BSP/Int	Rc 1/2	1/2 in BSP/Int	Rc 1/2	1/2 in BSP/Int
Flue Gas Temp.	200°C		205°C		195°C		160°C		125°C	
Flue Gas Volume	17 m³/h		18 m³/h		26 m³/h		31 m³/h		37 m³/h	
Gas Injector Orifice Diameter	2.95 mm	0.116 in	3.05 mm	0.120 in	3.86 mm	0.152 in	3.86 mm	0.152 in	4.22 mm	0.166 in
Flue Size (Secondary)	100 mm	4 in	100 mm	4 in	100 mm	4 in	125 mm	5 in	125 mm	5 in
Cold Water Feed Connection	R1	1 in BSPT/ExL	R1	1 in BSPT/ExL	R1	1 in BSPT/ExL	R1	1 in BSPT/ExL	R1 1/4	1 1/4 in BSPT/ExL
Hot Water Flow Connection	R1	1 in BSPT/ExL	R1	1 in BSPT/ExL	R1	1 in BSPT/ExL	R1	1 in BSPT/ExL	R1 1/4	1 1/4 in BSPT/ExL
Return Connection	Rp 3/4	3/4 in BSP	Rp 3/4	3/4 in BSP	Rp 3/4	3/4 in BSP	Rp 3/4	3/4 in BSP	Rp 3/4	3/4 in BSP
Drain Port Size	R 3/4	3/4 in BSPT/Ext	R 3/4	3/4 in BSPT/Ext	R 3/4	3/4 in BSPT/Ext	R 3/4	3/4 in BSPT/Ext	R 3/4	3/4 in BSPT/Ext
Maximum Working Pressure	10.3 bar	150 p.s.i.	10.3 bar	150 p.s.i.	10.3 bar	150 p.s.i.	10.3 bar	150 p.s.i.	10.3 bar	150 p.s.i.
Maximum Test Pressure	20.6 bar	300 p.s.i.	20.6 bar	300 p.s.i.	20.6 bar	300 p.s.i.	20.6 bar	300 p.s.i.	20.6 bar	300 p.s.i.
Weight Empty	43 kg	94 lbs	57 kg	126 lbs	65 kg	144 lbs	110 kg	244 lbs	181 kg	400 lbs
Weight Full	151 kg	334 lbs	202 kg	446 lbs	247 kg	544 lbs	396 kg	874 lbs	562 kg	1240 lbs
Shipping Weight	44 kg	98 lbs	59 kg	131 lbs	68 kg	150 lbs	120 kg	264 lbs	194 kg	428 lbs
Shipping Depth	546 mm	21 1/2 in	587 mm	23 1/2 in	587 mm	23 1/2 in	692 mm	27 1/4 in	914 mm	36 in
Dimensions Width	486 mm	19 1/4 in	537 mm	21 1/4 in	537 mm	21 1/4 in	651 mm	25 5/8 in	762 mm	30 in
Height	1194 mm	47 in	1245 mm	49 in	1499 mm	59 in	1575 mm	62 in	1829 mm	72 in
Mains Voltage (Automatic models only)	220/240 - IP20									
Frequency	50 Hz									
Power Consumption	236W									
Fuse	5 A									

Hi-Flo Range

Permanent pilot with piezo ignition and auto-ignition models

Models **32/143**, **65/173**, **81/264**, **62/341** are available as permanent Pilot (**PP**) models with Piezo Ignitor, or as **Auto** Ignition models with option **(1)** Remote control, fault indication, and flue-fan facility, or option **(2)** as **(1)** with the addition of a flue damper. Model **54/418** is available as **PP** only. Model **54/440** is available as **Auto** only.

NB. Service clearance I can be reduced to 300 mm if Correx Anodes are fitted.



0063

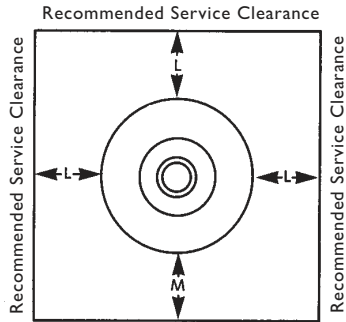

Plan View

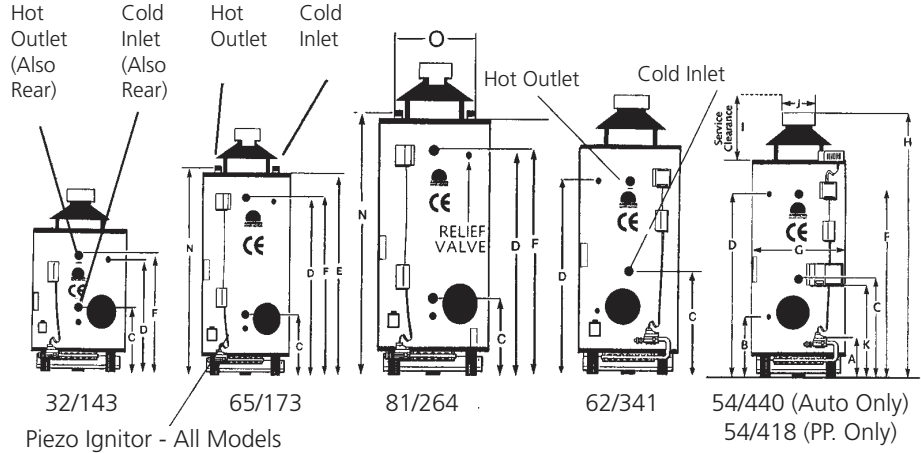

Andrews Model No.	32/143		65/173		81/264		62/341		54/418		54/440		
	SI METRIC	IMPERIAL	SI METRIC	IMPERIAL	SI METRIC	IMPERIAL	SI METRIC	IMPERIAL	SI METRIC	IMPERIAL	SI METRIC	IMPERIAL	
A Gas Connection	118 mm	4 3/8 in	118 mm	4 3/8 in	118 mm	4 3/8 in	264 mm	10 3/8 in	264 mm	10 3/8 in	264 mm	10 3/8 in	
B Drain Cock	384 mm	15 1/2 in	384 mm	15 1/2 in	384 mm	15 1/2 in	406 mm	16 in	406 mm	16 in	406 mm	16 in	
C Cold Water	492 mm	19 3/8 in	492 mm	19 3/8 in	492 mm	19 3/8 in	734 mm	28 7/8 in	744 mm	29 1/4 in	744 mm	29 1/4 in	
D Relief Valve Port	864 mm	34 in	1400 mm	55 1/2 in	1680 mm	66 1/2 in	1375 mm	54 1/2 in	1379 mm	54 1/4 in	1379 mm	54 1/4 in	
E Ht. of Heater	1096 mm	43 1/2 in	1632 mm	64 1/2 in	1911 mm	75 1/4 in	1676 mm	66 in	1635 mm	64 3/8 in	1635 mm	64 3/8 in	
F Hot Water	883 mm	34 3/4 in	1472 mm	58 in	1702 mm	67 in	1375 mm	54 1/2 in	1379 mm	54 1/4 in	1379 mm	54 1/4 in	
G Diameter	711 mm	28 in	711 mm	28 in	711 mm	28 in	711 mm	28 in	711 mm	28 in	711 mm	28 in	
H Ht. of Flue	1343 mm	53 in	1937 mm	76 3/4 in	2208 mm	87 in	1968 mm	77 1/2 in	1934 mm	76 1/2 in	1934 mm	76 1/2 in	
I Service Clearance	597 mm	23 5/8 in	1143 mm	45 in	1270 mm	50 in	1143 mm	45 in	1143 mm	45 in	1143 mm	45 in	
J Nominal Flue Diameter	150 mm	6 in	150 mm	6 in	200 mm	8 in	200 mm	8 in	250 mm	10 in	250 mm	10 in	
K Elect. Entry	-	381 mm	15 in	AUTO ONLY				584 mm	23 in	AUTO ONLY			
L Service Clearance	305 mm	12 ins	305 mm	12 ins	305 mm	12 ins	305 mm	12 ins	305 mm	12 ins	305 mm	12 ins	
M Service Clearance	800 mm	31 1/2 in	800 mm	31 1/2 in	800 mm	31 1/2 in	800 mm	31 1/2 in	800 mm	31 1/2 in	800 mm	31 1/2 in	
N Top Feed	-	-	1715 mm	67 1/2 in	1962 mm	77 3/4 in	-	-	-	-	-	-	
O Top Feed Centers	-	-	470 mm	18 1/2 in	470 mm	18 1/2 in	-	-	-	-	-	-	
Storage Capacity	145 lts	32 galls	295 lts	65 galls	368 lts	81 galls	282 lts*	62 galls	245 lts	54 galls	245 lts	54 galls	
Recovery thru 44°C/80°F	649 l/hr	143 g/hr	786 l/hr	173 g/hr	1199 l/hr	264 g/hr	1549 l/hr	341 g/hr	1900 l/hr	418 g/hr	1998 l/hr	440 g/hr	
56°C/100°F	517 l/hr	114 g/hr	629 l/hr	138 g/hr	959 l/hr	212 g/hr	1239 l/hr*	273 g/hr	1520 l/hr	334 g/hr	1598 l/hr	352 g/hr	
72°C/130°F	399 l/hr	88 g/hr	484 l/hr	106 g/hr	730 l/hr	162 g/hr	953 l/hr*	210 g/hr	1169 l/hr	257 g/hr	1223 l/hr	270 g/hr	
Heat Input	42.8 kW	146,034 Btu/hr	50.0 kW	170,600 Btu/hr	80 kW	272,960 Btu/hr	102.0 kW	348,024 Btu/hr	128.0 kW	436,736 Btu/hr	139.0 kW	474,268 Btu/hr	
Gas Family	NATURAL CAT I:H		NATURAL CAT I:H		NATURAL CAT I:H		NATURAL CAT I:H		NATURAL CAT I:H		NATURAL CAT I:H		
Burner Gas Pressure	6.8 mbar	2.73 in wg.	6.8 mbar	2.73 in wg.	6.8 mbar	2.73 in wg.	6.8 mbar	2.73 in wg.	6.8 mbar	2.73 in wg.	6.8 mbar	2.73 in wg.	
Max Gas Input Pressure	35 mbar	14.0 in wg.	35 mbar	14.0 in wg.	35 mbar	14.0 in wg.	35 mbar	14.0 in wg.	35 mbar	14.0 in wg.	35 mbar	14.0 in wg.	
Gas Flow Rate	4.0 m ³ /h	141 ft ³ /h	4.68 m ³ /h	164.76 ft ³ /h	7.44 m ³ /h	263.58 ft ³ /h	9.48 m ³ /h	336.24 ft ³ /h	11.94 m ³ /h	421.98 ft ³ /h	13.14 m ³ /h	465.06 ft ³ /h	
Gas Connection	Rp 3/4	3/4 in BSP/Int*	Rp 3/4	3/4 in BSP/Int*	Rp 3/4	3/4 in BSP/Int*	Rp 3/4	3/4 in BSP/Int*	Rp 3/4	3/4 in BSP/Int*	Rp 3/4	3/4 in BSP/Int*	
Flue Gas Temp.	117°C		140°C		150°C		195°C		185°C		215°C		
Flue Gas Volume	62m ³ /h		73m ³ /h		116m ³ /h		149m ³ /h		186m ³ /h		202m ³ /h		
Gas Injector Orifice Diameter	2.69 mm	0.106 in	2.87 mm	0.113 in	3.66 mm	0.144 in	3.45 mm	0.136 in	3.50 mm	0.138 in	3.66 mm	0.144 in	
Flue Size (Secondary)	150 mm	6 in	150 mm	6 in	200 mm	8 in	200 mm	8 in	250 mm	10 in	250 mm	10 in	
Cold Water Feed Connection	R 1 1/2	1 1/2 in BSPT/Ext	R 1 1/2	1 1/2 in BSPT/Ext	R 1 1/2	1 1/2 in BSPT/Ext	R 1 1/2	1 1/2 in BSPT/Ext	R 1 1/2	1 1/2 in BSPT/Ext	R 1 1/2	1 1/2 in BSPT/Ext	
Hot Water Flow Connection	R 1 1/2	1 1/2 in BSPT/Ext	R 1 1/2	1 1/2 in BSPT/Ext	R 1 1/2	1 1/2 in BSPT/Ext	R 1 1/2	1 1/2 in BSPT/Ext	R 1 1/2	1 1/2 in BSPT/Ext	R 1 1/2	1 1/2 in BSPT/Ext	
Return Connection	Rp 3/4	3/4 in BSP	Rp 3/4	3/4 in BSP	Rp 3/4	3/4 in BSP	Rp 3/4	3/4 in BSP	Rp 3/4	3/4 in BSP	Rp 3/4	3/4 in BSP	
Drain Port Size	R 3/4	3/4 in BSPT/Ext	R 3/4	3/4 in BSPT/Ext	R 3/4	3/4 in BSPT/Ext	R 3/4	3/4 in BSPT/Ext	R 3/4	3/4 in BSPT/Ext	R 3/4	3/4 in BSPT/Ext	
Max. Working Pressure	10.3 bar	150 p.s.i.	10.3 bar	150 p.s.i.	10.3 bar	150 p.s.i.	10.3 bar	150 p.s.i.	10.3 bar	150 p.s.i.	10.3 bar	150 p.s.i.	
Max. Test Pressure	20.6 bar	300 p.s.i.	20.6 bar	300 p.s.i.	20.6 bar	300 p.s.i.	20.6 bar	300 p.s.i.	20.6 bar	300 p.s.i.	20.6 bar	300 p.s.i.	
Weight Empty	190 kg	419 lbs	200 kg	441 lbs	289 kg	637 lbs	257 kg	566 lbs	269 kg	594 lbs	269 kg	594 lbs	
Weight Full	335 kg	738 lbs	495 kg	1091 lbs	656 kg	1447 lbs	538 kg	1186 lbs	514 kg	1134 lbs	514 kg	1134 lbs	
Shipping Weight	199 kg	438 lbs	223 kg	492 lbs	316 kg	697 lbs	282 kg	623 lbs	293 kg	645 lbs	293 kg	645 lbs	
Shipping Depth	902 mm	35 1/2 in	914 mm	36 in	914 mm	36 in	914 mm	36 in	914 mm	36 in	914 mm	36 in	
Dimensions Width	768 mm	30 1/4 in	762 mm	30 in	762 mm	30 in	762 mm	30 in	762 mm	30 in	762 mm	30 in	
Height	1270 mm	50 in	1960 mm	77 in	2083 mm	82 in	1960 mm	77 in	1960 mm	77 in	1960 mm	77 in	
Mains Voltage (Automatic models only)	220/240 - IP20												
Frequency	50 Hz												
Power Consumption	236W												
Fuse	5 A												

Room Sealed

RSC150 & RSC190

* NB. Service clearance E can be reduced to 300 mm if Correx Anodes are fitted.

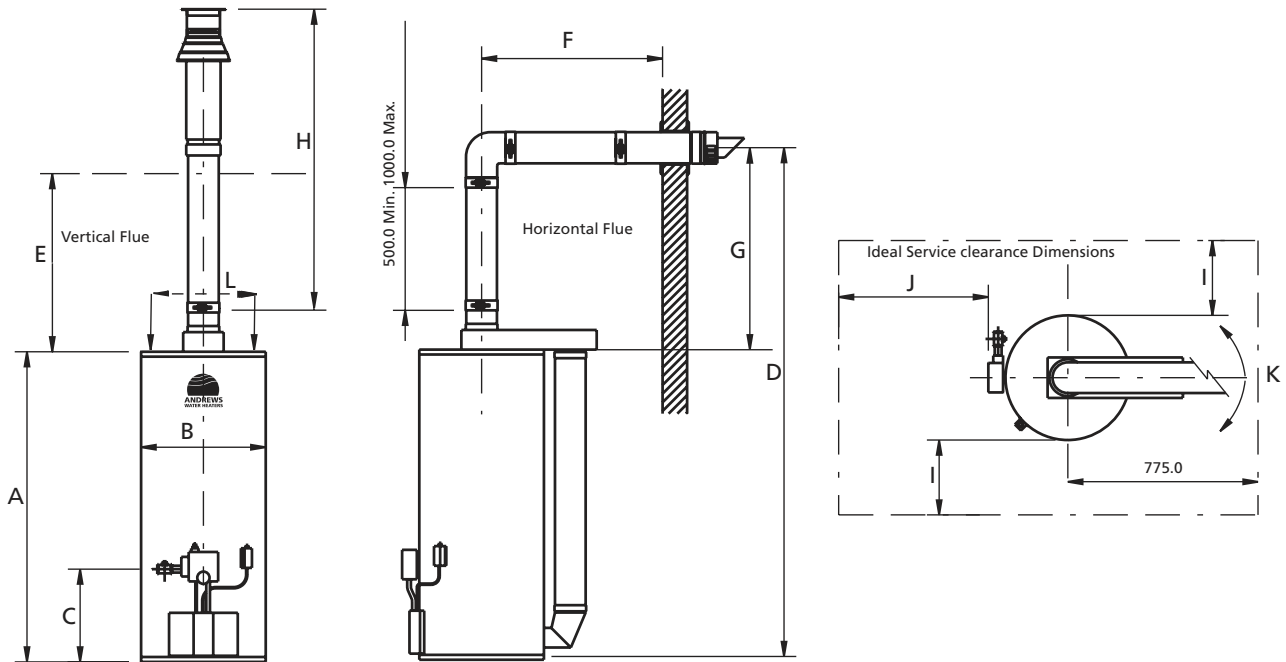

See installation manual for additional flue information.

Andrews Model No.	RSC 150		RSC 190	
	SI METRIC	IMPERIAL	SI METRIC	IMPERIAL
A Height of Heater	1264 mm	49 ³ / ₄ in	1492 mm	58 ³ / ₄ in
B Diameter	508 mm	20 in	508 mm	20 in
C Gas Connection	378 mm	14 ⁷ / ₈ in	378 mm	14 ⁷ / ₈ in
D Height to Centre of Flue	2170 mm	85 in	2398 mm	94 in
E Service Clearance*	1226 mm	48 in	1226 mm	48 in
F Horizontal Flue Length	775 mm Min. 1775 mm Max.			
G Min. from Centre of Flue	900 mm	35 in	900 mm	35 in
H Vertical Flue Height	750 mm Min. 3000 mm Max.			
I Service Clearance	305 mm	12 in	305 mm	12 in
J Service Clearance (Front)	610 mm	24 in	610 mm	24 in
K	We recommend that the flue outlet can be installed in any configuration through 360° as long as proper service clearances are observed.			
L Water Connection Centres	200 mm	7 ⁷ / ₈ ins	200 mm	7 ⁷ / ₈ ins
Storage Capacity	150 litres	33 gallons	190 litres	42 gallons
Recovery through 44°C/80°F	159 l/hr	35 gph	181 l/hr	40 gph
Recovery through 56°C/100°F	127 l/hr	28 gph	145 l/hr	32 gph
Heat Input	9.5 kW	32,414 Btu/hr	10.5 kW	35,826 Btu/hr
Heat Output	8.2 kW	27,978 Btu/hr	9.4 kW	32,073 Btu/hr
Gas Family	L ₂ H Natural		L ₂ H Natural	
Burner Pressure	10.0 mbar	4.0 wg.	10.0 mbar	4.0 wg.
Max. Gas Input Pressure	35.0 mbar	14.0 ins wg	35.0 mbar	14.0 ins wg.
Gas Flow Rate	0.88 m ³ /hr	31.32 ft ³ /hr	0.98 m ³ /hr	34.62 ft ³ /hr
Gas Connection	Rp 1/2	1/2 BSP	Rp 1/2	1/2 BSP
Flue Gas Temperature (approx)	180°C		180°	
Flue Gas Volume	16 m ³ /h		16 m ³ /h	
Injector Diameter	2.87 mm	0.113 ins	3.05 mm	0.120 ins
Flue Connection Diameter	80/125 mm		80/125 mm	
Inlet & Flow Connections	Rp 3/4	3/4 BSP	Rp 3/4	3/4 BSP
Return Connections	Rp 3/4	3/4 BSP	Rp 3/4	3/4 BSP
Drain Port Size	R 3/4	3/4 in BSPT/Ext	R 3/4	3/4 in BSPT/Ext
Maximum Working Pressure	10 bar	150 p.s.i.	10 bar	150 p.s.i.
Maximum Test Pressure	20.6 bar	300 p.s.i.	20.6 bar	300 p.s.i.
Weight Empty	66 kg	145 lbs	74 kg	163 lbs
Weight Full	216 kg	475 lbs	264 kg	583 lbs
Shipping Weight	73 kg	162 lbs	82 kg	181 lbs
Shipping Dimensions Carton	1499 x 635 x 711 mm	59 x 25 x 28 in	1727 x 635 x 711 mm	68 x 25 x 28 in
Mains Voltage	220/240 V- IP 20			
Frequency	50 Hz			
Fuse	5 Amp			

Room Sealed CSC Heaters

* NB. Ask for design guide for further flue information.

Models CSC39, CSC59, CSC78 and CSC93

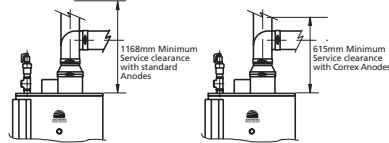
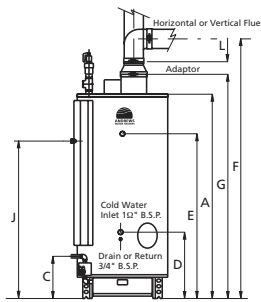

CSC39 and CSC59 Alternative Flue Systems

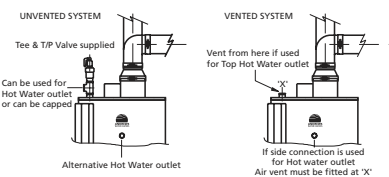
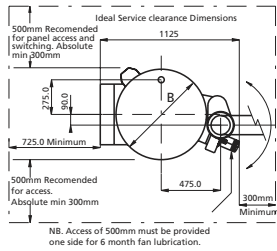
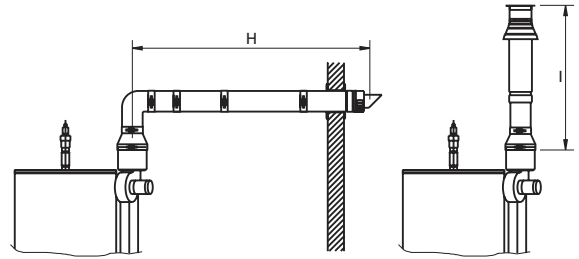

CSC78 and CSC93 Alternative Flue Systems

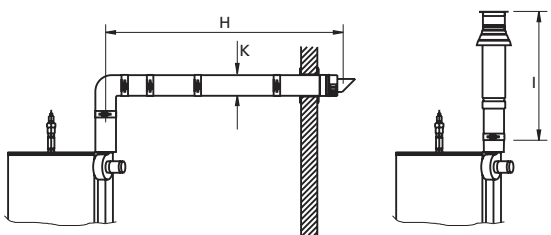

Andrews Model No.	CSC 39		CSC 59		CSC 78		CSC 93	
	SI METRIC	IMPERIAL	SI METRIC	IMPERIAL	SI METRIC	IMPERIAL	SI METRIC	IMPERIAL
A. Height of Heater	1623 mm	63 ⁷ / ₈ in	1623 mm	63 ⁷ / ₈ in	1623 mm	63 ⁷ / ₈ in	1851 mm	72 ⁵ / ₈ in
B. Diameter	720 mm	28 ¹ / ₄ in	720 mm	28 ¹ / ₄ in	720 mm	28 ¹ / ₄ in	720 mm	28 ¹ / ₄ in
C. Gas Connection	355 mm	14 in	355 mm	14 in	355 mm	14 in	355 mm	14 in
D. Cold Inlet	530 mm	20 ³ / ₄ in	530 mm	20 ³ / ₄ in	530 mm	20 ³ / ₄ in	530 mm	20 ³ / ₄ in
E. Hot Outlet	1307 mm	51 ³ / ₈ in	1307 mm	51 ³ / ₈ in	1535 mm	60 ³ / ₈ in	1535 mm	60 ³ / ₈ in
F. Height to C/L of Flue	2060 mm	81 in	2060 mm	81 in	1980 mm	78 in	2217 mm	87 in
G. Height to Flue Spigot	1780 mm	70 in	1780 mm	70 in	1780 mm	70 in	2020 mm	80 in
H. Min. Flue Horizontal	840 mm	33 in	840 mm	33 in	770 mm	38 in	970 mm	38 in
Max. Flue Horizontal	7000 mm	276 in	7000 mm	276 in	7000 mm	276 in	7000 mm	276 in
I. Min. Flue Vertical	1310 mm	51 ¹ / ₂ in	1310 mm	51 ¹ / ₂ in	1610 mm	63 ³ / ₈ in	1610 mm	63 ³ / ₈ in
Max. Flue Vertical	7000 mm	276 in	7000 mm	276 in	7000 mm	276 in	7000 mm	276 in
J. Electrical Connection	1250 mm	49 ¹ / ₄ in	1250 mm	49 ¹ / ₄ in	1250 mm	49 ¹ / ₄ in	1480 mm	58 ¹ / ₄ in
K. Flue Diameter	100/150 mm		100/150 mm		130/200 mm		130/200 mm	
L. Flue Adaptor	95 mm	3 ³ / ₄ in	95 mm	3 ³ / ₄ in	Not supplied with these models			
Storage Capacity	276 l	61 gals	276 l	61 gals	276 l	61 gals	350 l	77 gals
Rec. Thro 44°C/80°F	749 l/hr	165 gph	1149 l/hr	253 gph	1517 l/hr	334 gph	1808 l/hr	398 gph
Rec. Thro 56°C/100°F	600 l/hr	132 gph	922 l/hr	203 gph	1213 l/hr	267 gph	1445 l/hr	318 gph
Heat Input	44 kW	150,128 Btu/hr	66 kW	225,192 Btu/hr	88 kW	300,256 Btu/hr	106 kW	361,672 Btu/hr
Heat Output	38.7 kW	132,044	59.4 kW	202,673	78.3 kW	267,159	93.3 kW	318,339
Gas Family	1 ₂ H Natural Gas							
Burner Pressure	11.25 mbar	4.5in wg	11.25 mbar	4.5in wg	11.25 mbar	4.5in wg	11.25 mbar	4.5in wg
Max. Gas Input Pressure	35.0 mbar	14.0 ins wg.	35.0 mbar	14.0 ins wg.	35.0 mbar	14.0 ins wg.	35.0 mbar	14.0 ins wg.
Gas Flow Rate	4.09 m ³ /hr	144.6 ft ³ /hr	6.15 m ³ /hr	217.2 ft ³ /hr	8.20 m ³ /hr	289.8 ft ³ /hr	9.88 m ³ /hr	349.2 ft ³ /hr
Gas Connection	Rp ³ / ₄	³ / ₄ in BSP	Rp ³ / ₄	³ / ₄ in BSP	Rp ³ / ₄	³ / ₄ in BSP	Rp ³ / ₄	³ / ₄ in BSP
Flue Gas Temperature (approx)	132°C				171°C			
Flue Gas Volume	110m ³ /h		109m ³ /h		140m ³ /h		164m ³ /h	
Injector Dia.	2.4 mm	0.94 in	2.9 mm	0.114 in	2.9 mm	0.114 in	3.1 mm	0.122 in
M. Flue Connection	100/150 mm	-	100/150 mm	-	130/200 mm	-	130/200 mm	-
Inlet and Flow Cons	Rp1 ¹ / ₂	1 ¹ / ₂ in BSP	Rp1 ¹ / ₂	1 ¹ / ₂ in BSP	Rp1 ¹ / ₂	1 ¹ / ₂ in BSP	Rp1 ¹ / ₂	1 ¹ / ₂ in BSP
Return Connection	Rp ³ / ₄	³ / ₄ in BSP	Rp ³ / ₄	³ / ₄ in BSP	Rp ³ / ₄	³ / ₄ in BSP	Rp ³ / ₄	³ / ₄ in BSP
Drain Port Size	R ³ / ₄	³ / ₄ in BSPT/Ext	R ³ / ₄	³ / ₄ in BSPT/Ext	R ³ / ₄	³ / ₄ in BSPT/Ext	R ³ / ₄	³ / ₄ in BSPT/Ext
Max. Working Pressure	10 bar	150 psi	10 bar	150 psi	10 bar	150 psi	10 bar	150 psi
Maximum Test Pressure	20.6 bar	300 psi	20.6 bar	300 psi	20.6 bar	300 psi	20.6 bar	300 psi
Weight Empty	340 kg	750 lb	340 kg	750 lb	345 kg	760 lb	381 kg	840 lb
Weight Full	636 kg	1402 lb	636 kg	1402 lb	641 kg	1412 lb	727 kg	1603 lb
Shipping Weight	354 kg	780 lb	354 kg	780 lb	358 kg	790 lb	399 kg	880 lb
Shipping Dimension	770 x 1210 x 2110 mm	30 ¹ / ₄ x 47 x 83 in	770 x 1210 x 2110 mm	30 ¹ / ₄ x 47 x 83 in	770 x 1210 x 2110 mm	30 ¹ / ₄ x 47 x 83 in	770 x 1210 x 2110 mm	30 ¹ / ₄ x 47 x 83 in
Mains Voltage	220/240 V- IP 20							
Frequency	50 Hz							
Fuse	5 Amp							

Fan Flued

Models RFF 190 and RFF 280

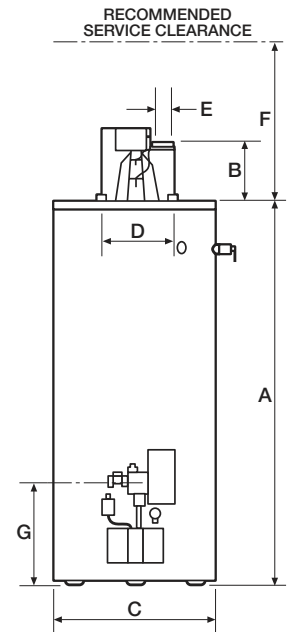
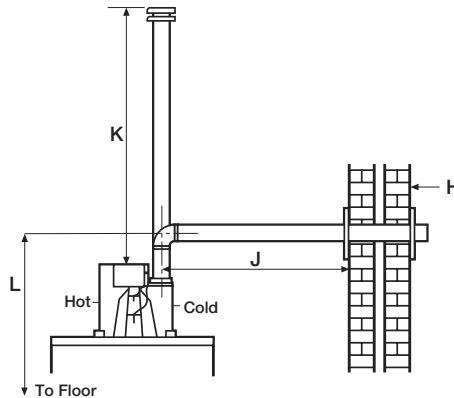
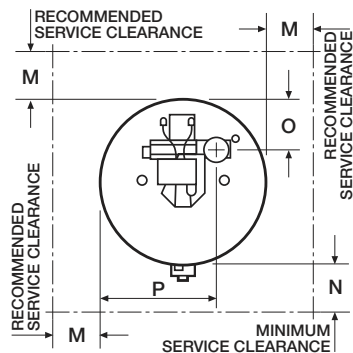

Andrews Model No.	RFF 190		RFF 280	
	SI METRIC	IMPERIAL	SI METRIC	IMPERIAL
A. Height of Heater	1448 mm	57 in	1524 mm	60 in
B. Height of Flue Spigot	267 mm	10½ in	267 mm	10½ in
C. Diameter	559 mm	22 in	660 mm	26 in
D. Water Connection Centres	279 mm	11 in	279 mm	11 in
E. Flue Spigot Connection	80 mm	3 in	80 mm	3 in
F. Service Clearance	1400 mm	55 in	1400 mm	55 in
G. Gas Connection	356 mm	14 in	395 mm	15½ in
H. Min./Max. Wall Thickness	150-300 mm	6-12 in	150-300 mm	6-12 in
J. Min Flue Horizontal	483 mm	19 in	533 mm	21 in
Max Flue Horizontal	7000 mm	276 in	4000 mm	156 in
K. Max. Flue Vertical	8000 mm	315 in	5000 mm	197 in
L. Height to Flue Centre from Floor	1867 mm	73½ in	1943 mm	76½ in
M. Service Clearance	305 mm	12 in	305 mm	12 in
N. Service Clearance Front	610 mm	24 in	610 mm	24 in
O. Flue Connection Centre	171 mm	6¾ in	222 mm	8¾ in
P. Flue Connection Centre	394 mm	14 in	444 mm	17½ in
NB: Dimensions J.K. should be decreased by 1000 mm for every 90° bend and 500 mm for every 45° bend used.				
Storage Capacity	190 l	42 gals	280 l	62 gals
Recovery thro 44°C/80°F	291 l/hr	64 gph	339 l/hr	75 gph
56°C/100°F	232 l/hr	51 gph	272 l/hr	60 gph
Heat Input	19.5 kW	66,534 Btu/hr	23.0 kW	78,476 btu/hr
Heat Output	15.0 kW	51,180 Btu/hr	17.5 kW	59,710 btu/hr
Gas Family		½ H Natural		
Burner Pressure	10 mbar	4in wg	10 mbar	4in wg
Max. Gas Input Pressure	35.0 mbar	14.0 ins wg.	35.0 mbar	14.0 ins wg.
Gas Flow Rate	1.82 m³/hr	64.3 ft³/hr	2.15 m³/hr	76 ft³/hr
Gas Connection	RP½	½in BSP	RP½	½in BSP
Flue Gas Temperature (approx)	70°C	158°F	70°C	158°F
Flue Gas Volume	32 m³/h		29 m³/h	
Injector Diameter	3.81 mm	0.150 in	3.98 mm	0.157 in
Flue Spigot Connection	80 mm	3 in	80 mm	3 in
Inlet and Flow Connections	RP¾	¾ in BSP	RP¾	¾ in BSP
Return Connection	RP¾	¾ in BSP	RP¾	¾ in BSP
Drain Port Size	R ¾	¾ in BSPT/Ext	R ¾	¾ in BSPT/Ext
Max. Working Pressure	10 bar	150 psi	10 bar	150 psi
Max. Test Pressure	20.6 bar	300 psi	20.6 bar	300 psi
Weight Empty	75 kg	165 lb	132 kg	292 lb
Weight Full	273 kg	603 lb	418 kg	908 lb
Shipping Weight	84 kg	185 lbs	144 kg	317 lbs
Shipping Dimension Carton	648 x 584 x 1753 mm	25⅝ x 23 x 69 in	1854 x 725 x 785 mm	73 x 28½ x 31 in
Mains Voltage	220/240 - IP20			
Frequency	50 Hz			
Power Consumption	236W			
Fuse	5 A			

Storage Water Tanks-Direct

Models ST66, ST100, ST166

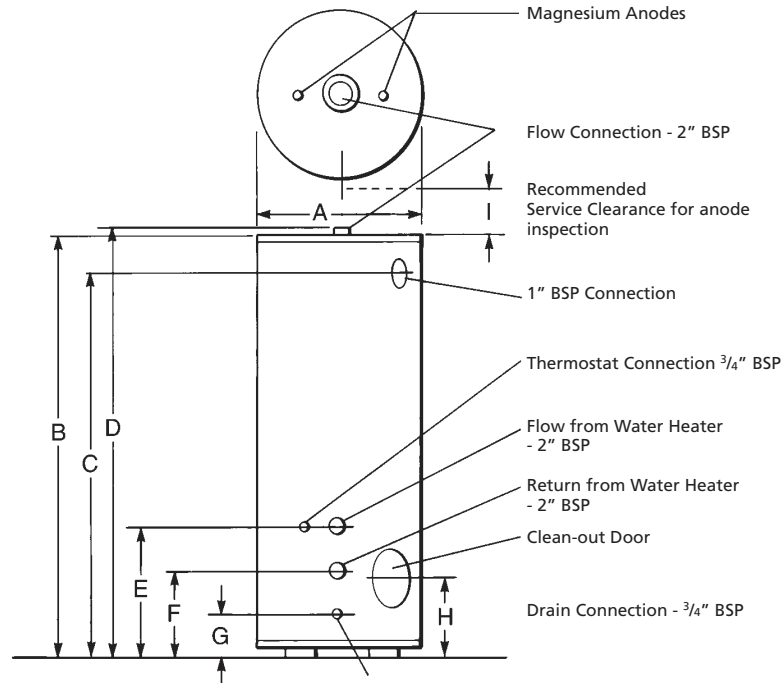

Features:

- **Foamlock Insulation** - a full 2" of polyurethane foam exceeds the insulating value of 5" of 1/2 lb density fibreglass insulation and gives extra jacket rigidity.
- **Vitraglas lined tank** - storage tanks are protected from the corrosive effects of hot water by an exclusive ceramic porcelain-like coating. Vitras tough interior surface for storage tanks, which must withstand the wearing effects of high volume and high temperature hot water.
- **Factory installed dielectric nipples** - no dielectric fittings or unions needed.
- **Two magnesium anode rods** - for more even distribution of corrosion protection and longer service life.
- **Hand hole clean-out** - for removal of accumulated lime and sediment deposits
- **Solid brass drain valve**
- **Steel tank** - heavy gauge steel automatically formed, rolled and welded to assure a continuous seam for glass lining. Each tank is triple tested to insure quality.

Dimensions						
Model	ST66		ST100		ST166	
	SI Units	Imp	SI Units	Imp	SI Units	Imp
A	610mm	24"	711mm	28"	813mm	32"
B	1492mm	58 3/4"	1588mm	62 1/2"	1956mm	77"
C	1334mm	52 1/2"	1416mm	55 3/4"	1676mm	66"
D	1518mm	59 3/4"	1613mm	63 1/2"	1981mm	78"
E	368mm	14 1/2"	368mm	14 1/2"	413mm	16 1/4"
F	235mm	9 1/4"	241mm	9 1/2"	286mm	11 1/4"
G	121mm	4 3/4"	127mm	5"	171mm	6 3/4"
H	184mm	7 1/4"	191mm	7 1/2"	235mm	9 1/4"
I	762mm	30"	762mm	30"	762mm	30"

ANDREWS MODEL NO.	ST 66		ST 100		ST 166	
	SI Units	Imp.	SI Units	Imp.	SI Units	Imp.
Storage Capacity	300 litres	66 gallons	455 litres	100 gallons	755 litres	166 gallons
Flow Connection	Rc2	2 in BSP T/Int.	Rc2	2 in BSP T/Int.	Rc2	2 in BSP T/Int.
Inlet Connection	Rc2	2 in BSP T/Int.	Rc2	2 in BSP T/Int.	Rc2	2 in BSP T/Int.
Return Connection	Rc2	2 in BSP T/Int.	Rc2	2 in BSP T/Int.	Rc2	2 in BSP T/Int.
Thermostat Connection	Rc 3/4	3/4 in BSP/Int.	Rc 3/4	3/4 in BSP/Int.	Rc 3/4	3/4 in BSP/Int.
Weight Empty	95.2 kg	210 lbs	141 kg	310 lbs	245 kg	541 lbs
Weight Full	395 kg	870 lbs	594 kg	1310 lbs	998 kg	2201 lbs
Maximum Working Pressure	10.3 bar 150 psi	10.3 bar 150 psi	10.3 bar 150 psi	10.3 bar 150 psi	10.3 bar 150 psi	10.3 bar 150 psi
Maximum Test Pressure	20.6 bar 300 psi	20.6 bar 300 psi	20.6 bar 300 psi	20.6 bar 300 psi	20.6 bar 300 psi	20.6 bar 300 psi
Shipping Weight	107 kg	235 lbs	154 kg	340 lbs	263 kg	581 lbs
Shipping Height	1537mm	60 1/2"	1638mm	64 1/2"	2019mm	79 1/2"
Crate Width	667mm	26 1/4"	787mm	31"	889mm	35"
Dimensions Depth	667mm	26 1/4"	762mm	30"	889mm	35"

Andrews Mini-Plate

ADD-ON SPACE HEATING PACKAGE

When the heating demand is small but high volume hot water is required the combination of an Andrews Mini Plate and an Andrews Water Heater provides the complete solution. A plate heat exchanger, pumps and electronic control assembly neatly packaged inside a compact enclosure provide an add-on space heating function for Andrews Water Heaters.

Features include:

- Compact
- Long life high grade materials
- Maintenance free
- Stainless steel brazed plate heat exchanger
- Bronze pump for domestic water
- Circulation pump for space heating
- Automatic electronic control system
- Temperature and pressure gauge included
- Completely assembled and ready to install

It
is
designed
specifically
for

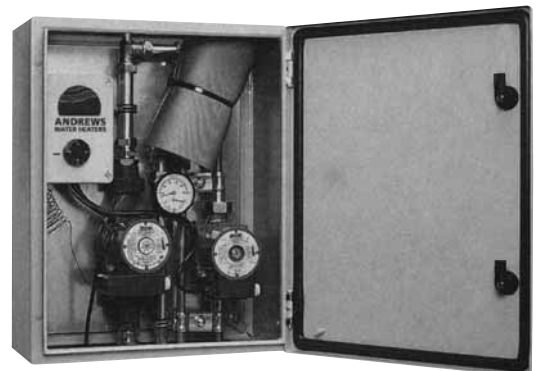

Applications:

- Shower rooms at sports clubs, caravan/camping sites
- Can be used with underfloor heating or radiators
- Small apartment heating
- Low background heating requirements
- Can be used with Andrews Water Heaters on Natural gas, LPG or oil.

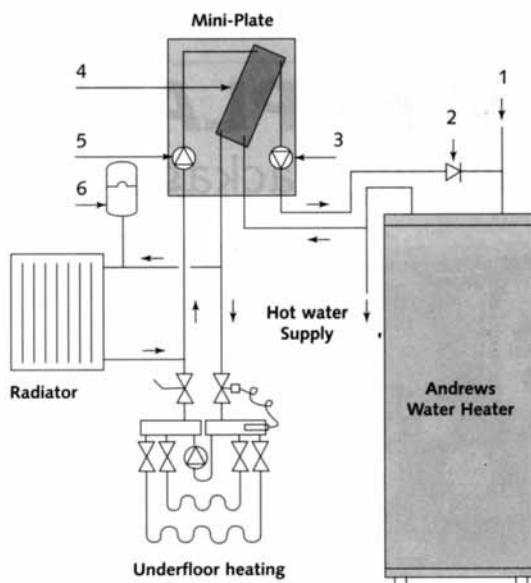

Technical Data	
Height	500 mm
Width	400 mm
Depth	200 mm
Weight	16 kg
Maximum capacity of heat exchanger*	23 kW
Water connection heating side	22 mm
Water connection, domestic side	15 mm
Electrical supply	220/240 1ph 50 Hz
Electrical load, pumps	104 W
Electrical load, control panel	20 W
* Dependent upon water temperatures	

Typical System Layout

1. Cold feed (See Andrews Water Heater Installation Manual)
2. Non return valve
3. Bronze domestic water pump
4. Plate heat exchanger
5. Heating pump
6. Expansion tank

The maximum heating load of the Mini-Plate, will depend upon the Water Heater input. Size the Andrews Storage Water Heater in the normal way using the Size-it guide then add the heating load up to 23 kW maximum. In working conditions the electronic control will give priority to the domestic water heating load.



Andrews Water Heaters
Wood Lane, Erdington
Birmingham, B24 9QP
Telephone: 0845 070 1055 Facsimile: 0845 070 1057
E Mail: andrews@baxigroup.com
www.andrewswaterheaters.co.uk