

Etech p

57 - 115 - 144 - 201 - 259 [Tri phase]

*Installation, operating and
servicing instructions*



INDEX

WARNINGS

Who should read these instructions	3
Symbols	3
Recommendations	3
Importants notes	3

INTRODUCTION

Description of the specifications	4
Casing	4
Heating body	4
Heating elements	4
Connection	4
Control	4
Electrical protection	4

INSTRUCTIONS

User data	5
Setting up	5
Heating system pressure	5
Control panel legend	5

TECHNICAL CHARACTERISTICS

Electrical data	7
Power	7
Nominal current per phase	7

INSTALLATION : GENERAL

Dimensions	8
Installation room	8
Boiler room	8
Frost protection	8
Connecting to the system	8

INSTALLATION : HYDRAULIC

Heating connection	9
Heating connection + DWL	9

INSTALLATION : ELECTRIC SUPPLY

General safety rules	10
Important	10
Electrical connections	10
Sizing of supply wires	11
Power variation (kW) relative to voltage	11
Wiring diagrams	12
Power limitation	13
Powers wiring / Model : E-Tech P / 57	14
Powers wiring / Model : E-Tech P / 115	15
Powers wiring / Model : E-Tech P / 144	16
Powers wiring / Model : E-Tech P / 201	18
Powers wiring / Model : E-Tech P / 259	20

COMMISSIONING

Commissioning - Water	22
Commissioning - Electrical	22
Starting the boiler	22

MAINTENANCE

23

SPARE PARTS

See at the end of this manual

WARNINGS

WHO SHOULD READ THESE INSTRUCTIONS

These instructions should be read by:

- the specifying engineer
- the installer
- the user
- the service engineer

SYMBOLS

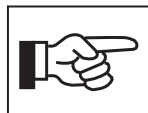

Essential instruction for the correct operation of the installation.



Essential instruction for the safety of persons and the environment.



Danger of electrocution.



Danger of burns

RECOMMENDATIONS



- These instructions are an integral part of the equipment to which they relate and must be handed to the user.
- The product must be installed and serviced by qualified engineers in accordance with the regulations in force.
- The manufacturer declines all liability for any damage caused as a result of incorrect installation or in the event of the use of appliances or accessories that are not specified by the manufacturer.
- Any failure to follow instructions relating to tests and test procedures may result in personal injury or risks of pollution.
- It is important to switch the boiler off from the external switching device before carrying out any work.
- There are no user parts inside the control panel.
- The installation must be in accordance with the current standards.

IMPORTANT NOTES



The manufacturer reserves the right to change the technical characteristics and specification of its products without notice.



The availability of certain versions and their accessories can vary following the market.



Warning : Do not switch ON if there is a possibility that the water in heater is frozen.

INTRODUCTION

DESCRIPTION OF THE SPECIFICATIONS:

This floor standing electric boiler is available in 5 models :

- Model 57 with a power of 57,6 kW
- Model 115 with a power of 115,2 kW
- Model 144 with a power of 144 kW
- Model 201 with a power of 201,6 kW
- Model 259 with a power of 259,2 kW

The power circuit is supplied with 400 Volt tri phases without neutral.

The control circuit is supplied with 230 Volt single phase.

CASING

The boiler is protected by a steel casing that has a red stove enamelled finish.

HEATING BODY

The boiler heating body is constructed from mild steel with welded joints. It is hydraulic tested at a pressure of 5,2 bar (maximum working pressure = 4 bar).

HEATING ELEMENTS

Immersion heaters, constructed from stainless steel Incoloy 800 are mounted in the front of the boiler, provide the heating source to the boiler.

CONNECTION

The boiler is suitable for connection to most heating and water process systems, with a maximum working pressure of 4 bars and a maximum temperature of 90°C. It can also be used in multiple boiler installations allowing greater outputs to be achieved.

The boiler and connection glands are provided for the power supply, the control supply and optional external controls.

CONTROL

The boiler is equipped with an electronic sequencing control that constantly adapts the power required thanks to a four stage modulation.

The boiler is commonly controlled by an external contact (i.e. room thermostat). The maximum power can be limited to 25%, 50% or 75% by moving electrical bridges.

ELECTRICAL PROTECTION

The control circuit is protected by an internal 3 Amp MCB.

The power circuit is protected at its input by 3 power fuses. Moreover, each contactor - supplying a pair of electric stars (28,8kW) - is protected by an automatic thermal and magnetic safety relay.

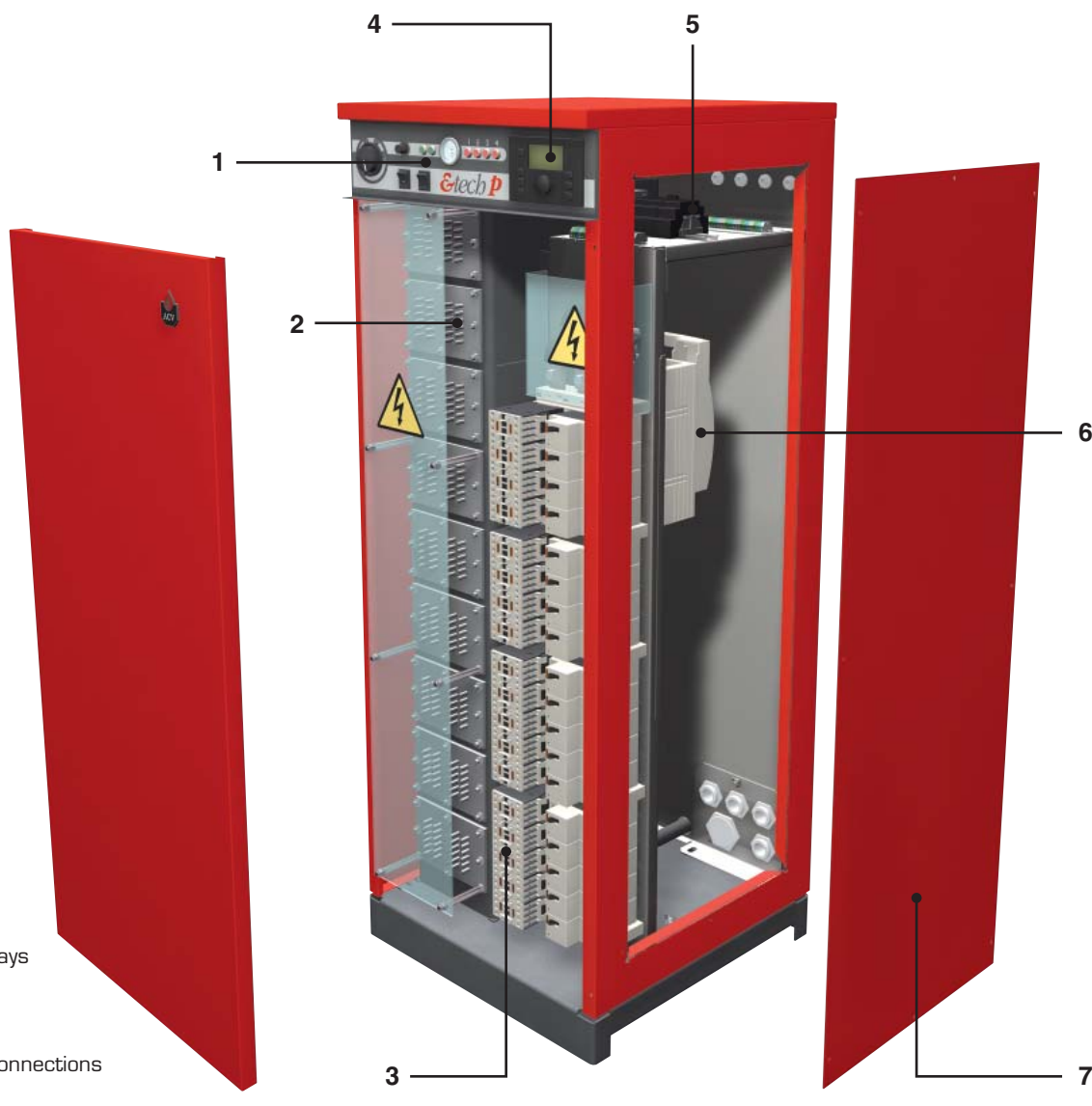

1. Control panel
2. Heating elements
3. Contactor and safety relays
4. Optional controller
5. Control circuit
6. Main fuses and power connections
7. Removable access panel

INSTRUCTIONS

USER DATA

All user controls are situated on the front panel of the boiler, there are no user controls inside the boiler casing. The following instructions assume that the boiler has been commissioned, and that the system is filled with water and has been fully vented.

SETTING UP

- Before switching on any electrical supplies to the boiler ensure that the combined temperature and pressure gauge reads at least 1 bar and the control thermostat is set to the desired temperature.
- If any other auxiliary controls are fitted e.g. programmer, room thermostats, cylinder thermostats etc, consult appropriate manufacturers' instructions to switch these on.
- Switch the winter/summer switch to winter position.
- Switch on any local means of isolation to boiler.



Ensure all the jacket panels are secured before switching on electrical supply from the external isolator.

- Switch the boiler on using the ON/OFF switch (a test of the lights is done).
- After a short period of time the boiler temperature should start to rise, indicated on combined temperature and pressure gauge. The modulation level is displayed on the front panel by the stage indicator lights. If the boiler fails to operate, the overheat safety thermostat should be checked. Access to the thermostat reset button is obtained by unscrewing (anti-clockwise) the domed button cover on the front panel (a screwdriver is not required). The reset button can then be seen - press the button, a click should be heard and the button is reset. If no click was heard the device is not at fault and further investigation is required by a suitably qualified engineer.
- The external programmer can now be set to allow on/off periods as desired. The ON/OFF switch should be left in the ON position during normal use.



The power level indicator will automatically light on and off during normal boiler operation, depending on boiler temperature.

- If the boiler is not in regular daily use during cold periods, it is recommended that it is fitted with a frost sensing thermostat to prevent the system from freezing.

- As with most boilers and heating appliances the casing and pipework can get hot during normal running so the boiler must not be covered and the surrounding area must be kept clear.

HEATING SYSTEM PRESSURE

The CH pressure must be a minimum of 1 bar and must be checked by the end user on a regular basis. If the pressure drops under 0.5 bar, the integrated water pressure switch blocks the appliance until the pressure in the system returns to a level above 0.8 bar.

The installer must fit an external filling loop to the system.

For more information, please ask your installer when the system is delivered.

A pressure safety valve is provided with the appliance. If the system pressure exceeds 4 bars, this valve opens and drains the water from the system. In this case, please contact your installer.

CONTROL PANEL LEGEND

1. Control thermostat :
1 = 25°C
2 = 40°C
3 = 55°C
4 = 70°C
5 = 85°C
2. ON/OFF switch
3. Summer/Winter switch
4. Manual reset high limit thermostat
5. Overheating warning light
6. Minimum water pressure warning light
7. Combined temperature and pressure gauge
8. Power level indicators
9. Optional internal controller

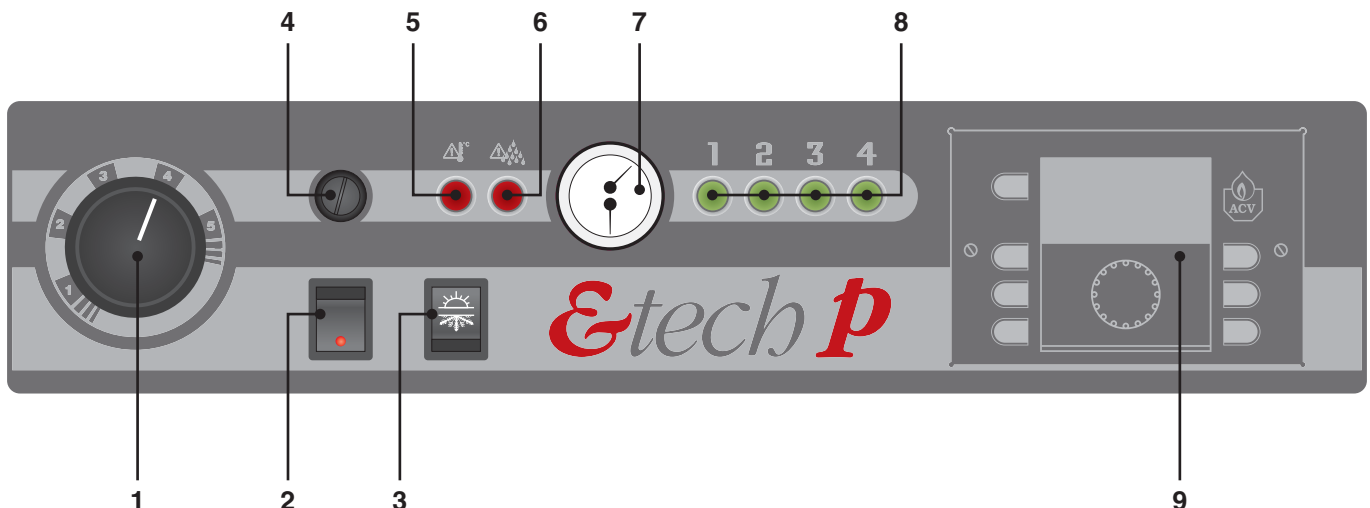

TECHNICAL CHARACTERISTICS

Model	57	115	144	201	259
Power	57,6 kW	115,2 kW	144 kW	201.6 kW	259,2 kW
Nominal supply voltage					
Power circuit	3 x 400 V	3 x 400 V	3 x 400 V	3 x 400 V	3 x 400 V
Control circuit	1 x 230 V 50/60 Hz	1 x 230 V 50/60 Hz	1 x 230 V 50/60 Hz	1 x 230 V 50/60 Hz	1 x 230 V 50/60 Hz
Heating element type	4 x 3 x 2.4 kW	4 x 3 x 2.4 kW	4 x 3 x 2.4 kW	4 x 3 x 2.4 kW	4 x 3 x 2.4 kW
Number of elements	2	4	5	7	9
Ohmic value of single resistance (2,4 kW)	22,0 Ohm	22,0 Ohm	22,0 Ohm	22,0 Ohm	22,0 Ohm
Water capacity (Litres)	60	60	60	102	102
Max. working pressure (bars)	4	4	4	4	4
Min. working pressure (bars)	0.8	0.8	0.8	0.8	0.8
Max. working temperature (°C)	90	90	90	90	90
Hydraulic pressure drop (mbar) [$\Delta T = 10^{\circ}C$]	20	79	123	20	33
Heating connection	2" [F]	2" [F]	2" [F]	DN 100 (*)	DN 100 (*)
Height (mm)	1495	1495	1495	1495	1495
Width (mm)	542	542	542	542	542
Depth (mm)	567	567	567	567	567
Weight empty (kg)	110	123	131	187	200

(*) DN100 flanges to be welded

TECHNICAL CHARACTERISTICS

POWER					
Models	Power (kW) Stage 1	Power (kW) Stage 2	Power (kW) Stage 3	Power (kW) Stage 4	Total Power (kW)
E-Tech P / 57	14,4	14,4	14,4	14,4	57,6
E-Tech P / 115	28,8	28,8	28,8	28,8	115,2
E-Tech P / 144	36,0	36,0	36,0	36,0	144,0
E-Tech P / 201	50,4	50,4	50,4	50,4	201,6
E-Tech P / 259	64,8	64,8	64,8	64,8	259,2

NOMINAL CURRENT PER PHASE					
Models	Stage 1 (A)	Stage 2 (A)	Stage 3 (A)	Stage 4 (A)	Total current per phase (A)
E-Tech P / 57	20,9	20,9	20,9	20,9	83,6
E-Tech P / 115	41,7	41,7	41,7	41,7	166,8
E-Tech P / 144	62,7	62,7	41,8	41,8	209
E-Tech P / 201	83,5	83,5	62,6	62,6	292,2
E-Tech P / 259	83,5	104,4	83,5	104,4	375,8

INSTALLATION : GENERAL

DIMENSIONS

Models	A mm	B mm	C mm	D mm	E mm	F mm	Heating connection
E-Tech P / 57	1495	567	550	183	542	125	2" [F]
E-Tech P / 115	1495	567	550	183	542	125	2" [F]
E-Tech P / 144	1495	567	550	183	542	125	2" [F]
E-Tech P / 201	1495	567	1100	183	542	125	DN 100
E-Tech P / 259	1495	567	1100	183	542	125	DN 100

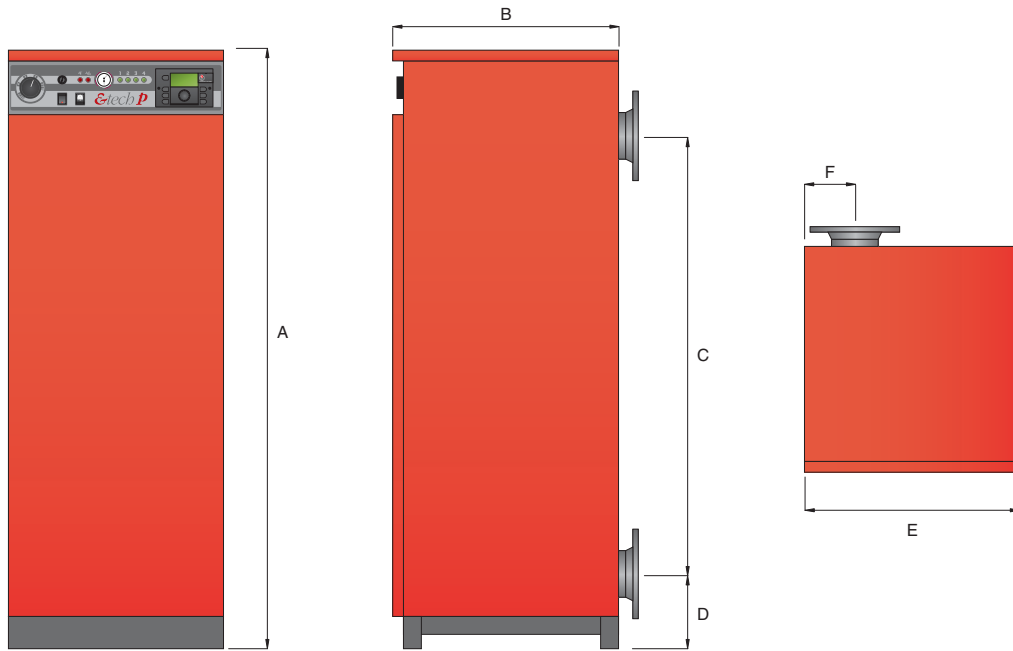

INSTALLATION ROOM

The minimum clearance around the appliance must comply with the figure shown opposite.

BOILER ROOM

- Electric boilers must be installed in boiler rooms complying with the relevant technical standards and applicable regulations.
- The appliance should never be installed outdoors, because it has not been designed for and is not equipped with automatic defrosting systems.
- If possible, install the boiler above the ground level, to reduce the risk of flooding the electrical components.

FROST PROTECTION

The boiler is NOT fitted with frost protection. If the boiler is being installed in a position where freezing could take place, then a suitable external frost thermostat should be fitted.

CONNECTING TO THE SYSTEM

The boiler is designed to operate on a sealed system (ie. no open vent or feed and expansion tank).

An adequate expansion vessel, sized accordingly must be installed in the system.

TOP VIEW

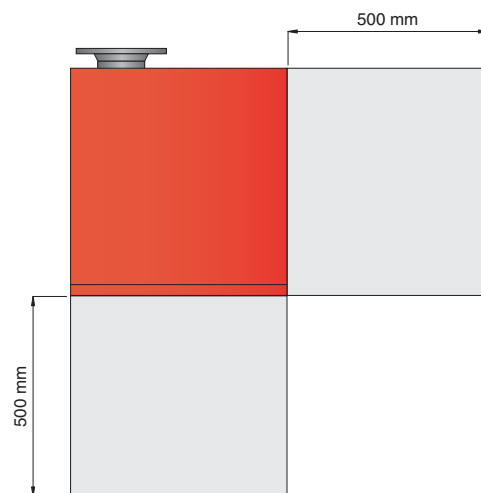

INSTALLATION : HYDRAULIC

HEATING CONNECTION

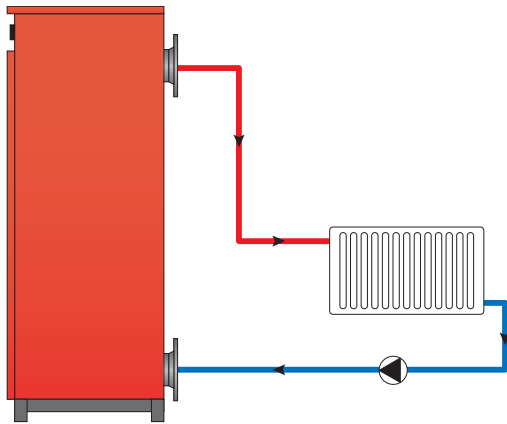

Adjustable temperature



- 1 = 25°C
- 2 = 40°C
- 3 = 55°C
- 4 = 70°C
- 5 = 85°C

0 - 90°C

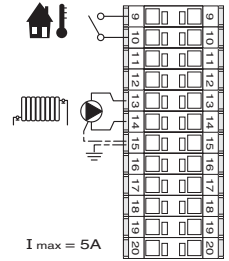

HEATING CONNECTION + DHW (2 Circulating pumps)



The controller is factory programmed with DHW priority. To cancel the DHW priority, remove the black wire from I7 and connect to I8 in the electronic controller.

Warning : Size the flow rate in hydraulic circuit to insure a 10°C maximum ΔT .



- 1 = 25°C
- 2 = 40°C
- 3 = 55°C
- 4 = 70°C
- 5 = 85°C

0 - 90°C

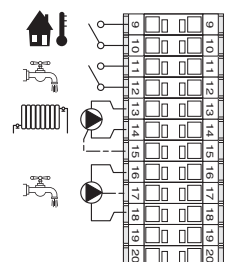
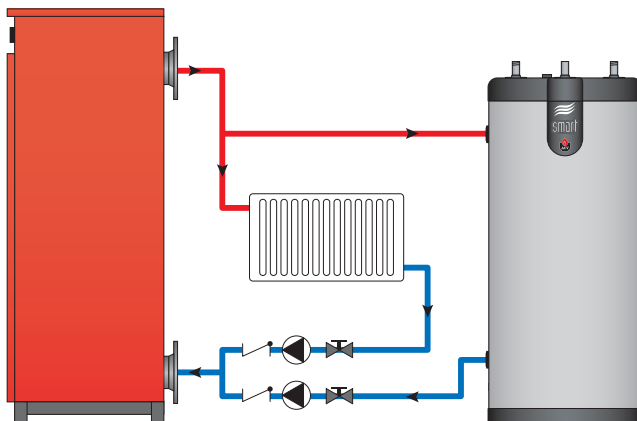
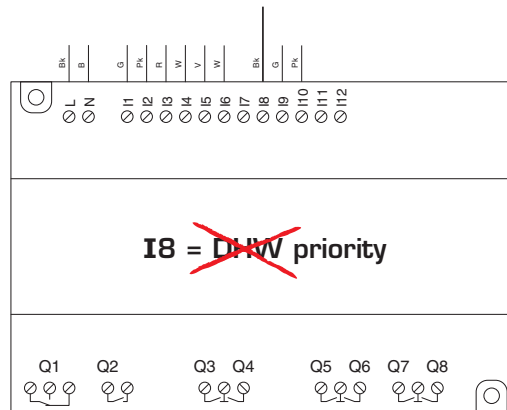
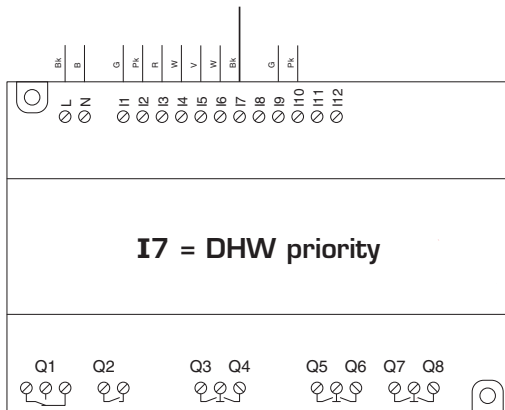

INSTALLATION : ELECTRIC SUPPLY

WARNING !!!

Size the flow rate in the hydraulic circuit to ensure a 10°C maximum ΔT .

GENERAL SAFETY RULES

- The boiler must be installed by a competent person or registered company.
- After the installation work, the installer must issue a statement of compliance, declaring that the installation has been carried out in a workmanlike manner, as defined for by the applicable regulations.
- Make sure that the wiring system and the power input lines are designed and installed by skilled engineers in compliance with the applicable regulations.

IMPORTANT

- As far as the power input to the boiler is concerned, the installation must comply with IEC 364 standards and other provisions concerning installation conditions.
- The default electrical safeties integrated in the boiler protect the internal parts of the boiler. Electrical safeties, including isolators **must** be installed in an external box.
- For protection against electrical hazard, it is always recommended to install a differential cut-out device (Ground Fault Isolator) on the power supply circuit, upstream of the boiler.
- For protection against overheating, it is advisable to place an external positive safety power cut-out, controlled by the boiler safety thermostat.

ELECTRICAL CONNECTIONS

1. Remove the right panel cover and the top panel
2. Connect the electrical supply to the control circuit and all accessories (room thermostat, ...)
3. Pass the power cables through the cable glands located in the rear panel.

8. Remount the bottom protection and close the power connections box.

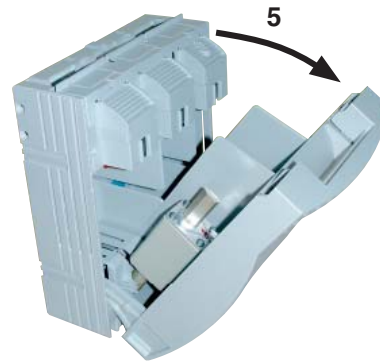

Models	Standard cable gland	Optional cable gland (*)
E-Tech P / 57	1 x PG 36	4 x PG 21
E-Tech P / 115	1 x PG 48	4 x PG 21
E-Tech P / 144	1 x PG 48	4 x PG 21
E-Tech P / 201	4 x PG 29	1 x PG 48
E-Tech P / 259	4 x PG 29	1 x PG 48

(*) Optionally, the installer has the possibility to remove the standard cable glands and install the optional cable glands (not supplied) on site.

4. Connect the earth using a ring terminal.
5. Open the power connections box.
6. Remove the bottom protection.
7. Connect the power wires to the main connections using ring terminals.

(*) a transformation kit is supplied with the boiler in order to connect the power wires using compression terminals (see detailed instructions sheet in the kit).

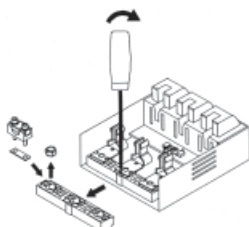
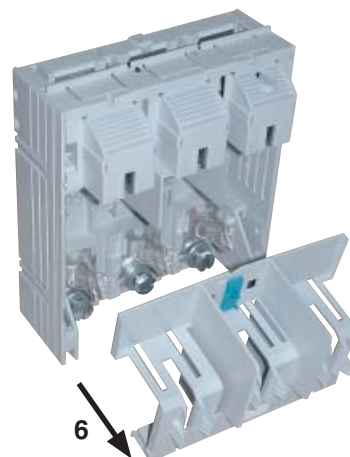

Optional connection

INSTALLATION : ELECTRIC SUPPLY

SIZING OF SUPPLY WIRES

The supply wires are sized depending of the type and current of the MCB. The MCB last is sized depending of the nominal current of the boiler. The admissible current of the supply wires depends of the ambient temperature, the section, the length and the insulation of the wires, the wires ducts, the mounting and the environment.

The following values are given for information for an ambient temperature of 25°C and a maximum length of 5 meters. In all the circumstances, the installation must be in accordance with the current IEE wiring regulations.

Diameter mm ²	Current Amp
1,5	16
2,5	25
4,6	36
10	47
16	65
25	87
35	115
50	143
70	178
95	220
120	265
150	310
185	355
240	480

For higher temperatures, the supply wire diameter should be adapter according the derating factor.

T ambient °C	Current derating %
25	100
30	92
35	85
40	75
45	65
50	53
55	38

POWER VARIATION (kW) RELATIVE TO VOLTAGE

Models	3 x 380 V	3 x 400 V	3 x 415 V	3 x 440 V
E-Tech P / 57	51,4	57,6	62,0	70
E-Tech P / 115	103,8	115,2	124,0	139
E-Tech P / 144	130,0	144,0	155,0	174
E-Tech P / 201	181,4	201,6	217,0	244
E-Tech P / 259	233,7	259,2	279,0	314

INSTALLATION : ELECTRIC SUPPLY

WIRING DIAGRAMS

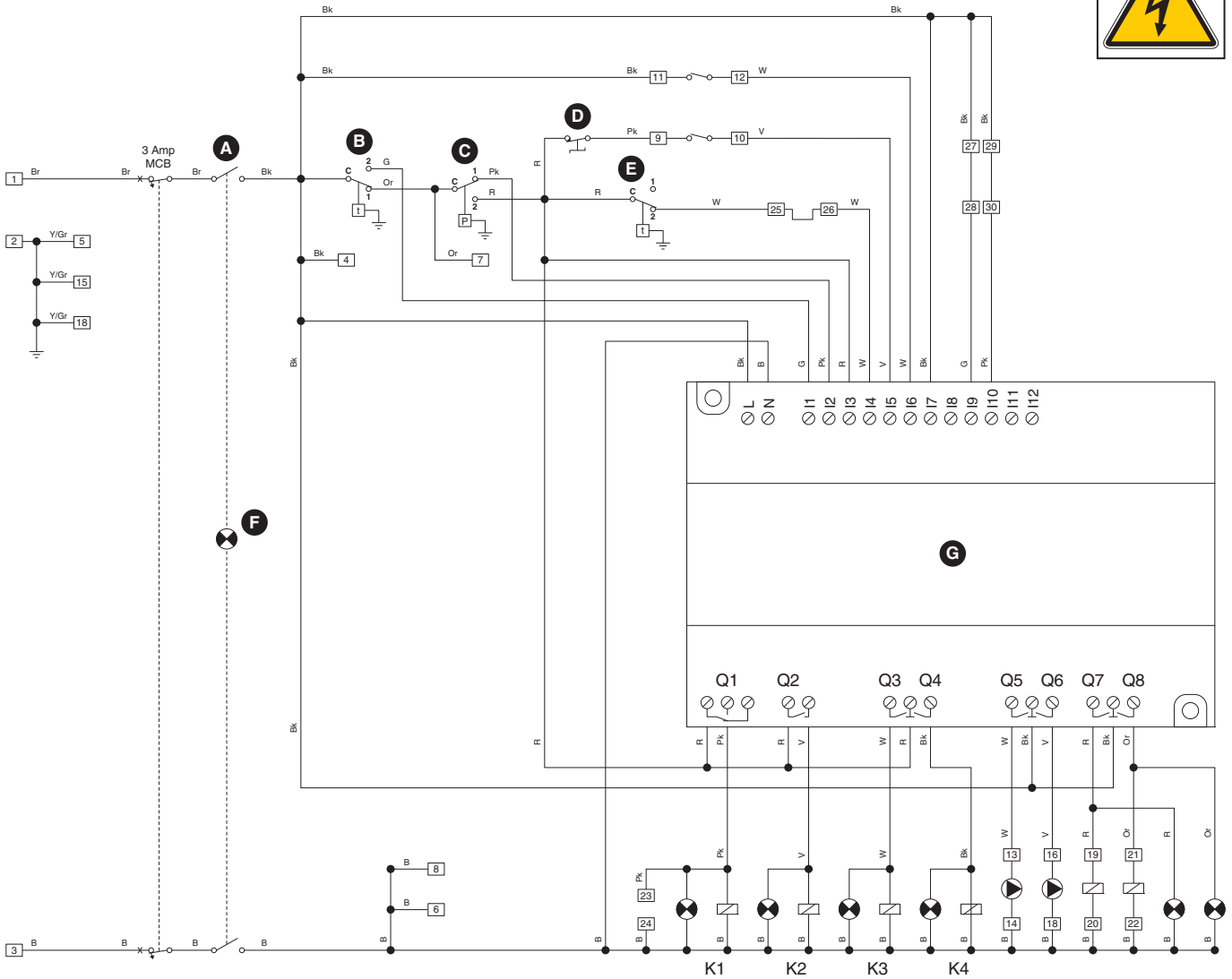

- B : Blue
- Bk : Black
- Br : Brown
- G : Grey
- Or : Orange
- Pk : Pink
- R : Red
- V : Violet
- W : White
- Y : Yellow
- Y/Gr : Yellow/Green

- A ON/OFF switch
- B Manual reset high limit thermostat
- C Water pressure switch
- D Summer / Winter switch
- E Boiler thermostat O - 90°C
- F Alarm indicator
- G Electronic controller

- I1 High temperature
- I2 Water pressure
- I3 Common alarm signal
- I4 Boiler demand
- I5 Central heating demand
- I6 DHW demand
- I7 DHW priority
- I8 Without DHW priority
- I9 SW1 (power limitation)
- I10 SW2 (power limitation)
- Q1 K1
- Q2 K2
- Q3 K3
- Q4 K4
- Q5 Heating pump
- Q6 DHW pump
- Q7 Water pressure warning light
- Q8 High temperature warning light

INSTALLATION : ELECTRIC SUPPLY

POWER LIMITATION :

The maximum power of the boiler can be limited from 25 to 100% by acting on the SW1, SW2 electrical bridges as mentioned in the table below.



Any change to the power limitation will alter the current once the boiler has switched to stand-by (busy signal is OFF). The external management system can then open the ON/OFF link.

Power	25%	50%	75%	100%
SW1	0	1	0	1
SW2	0	0	1	1

25% = Only 1 stage

50% = Only 1 and 2 stages

75% = Only 1 to 3 stages

100% = All stages

CONTROL CIRCUIT TERMINAL

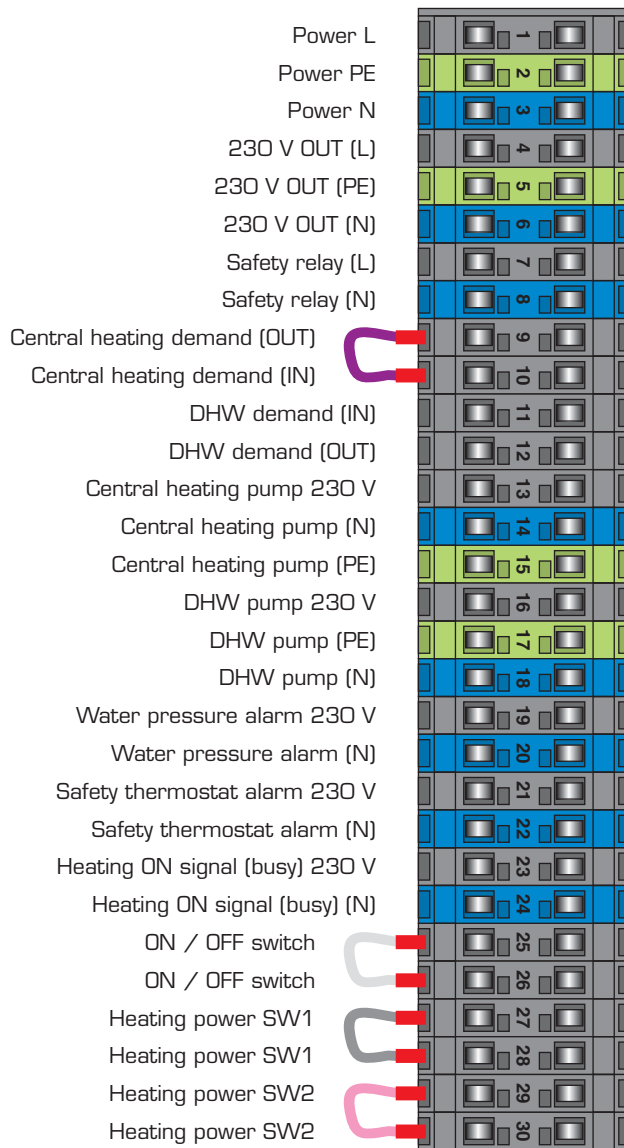

INSTALLATION : ELECTRIC SUPPLY

POWER WIRING / MODEL : E-TECH P / 57

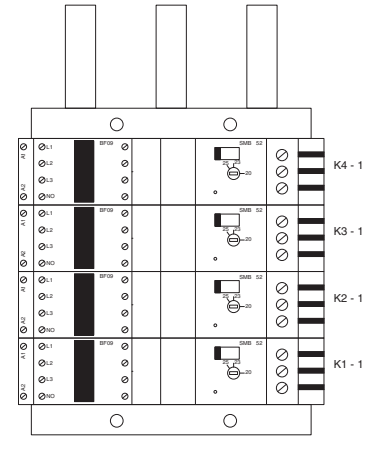
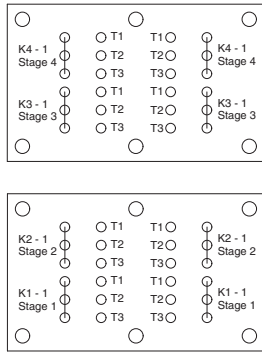
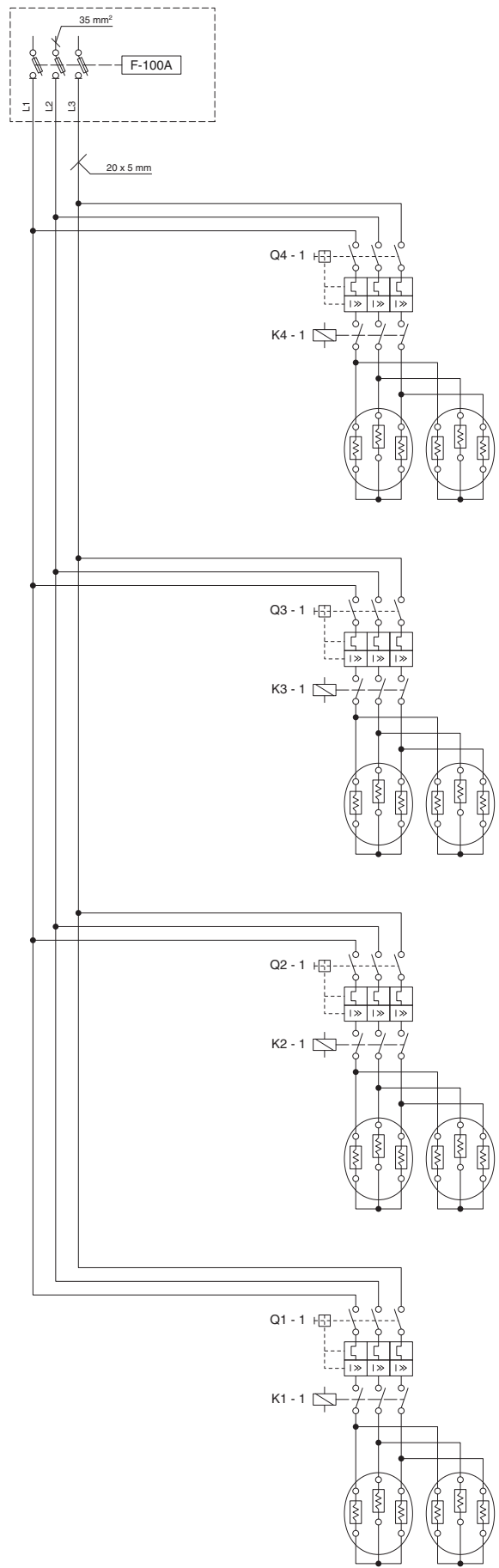

INSTALLATION : ELECTRIC SUPPLY

POWER WIRING / MODEL : E-TECH P / 115

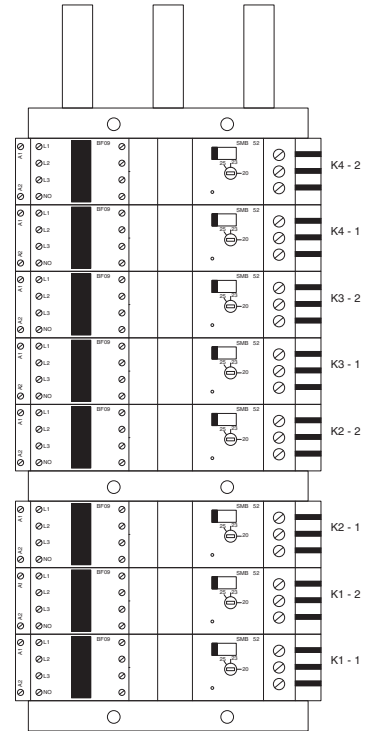
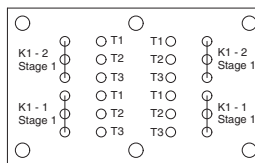
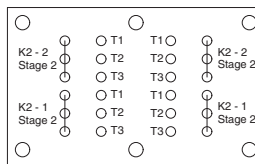
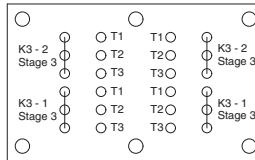
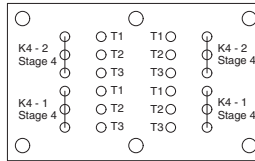
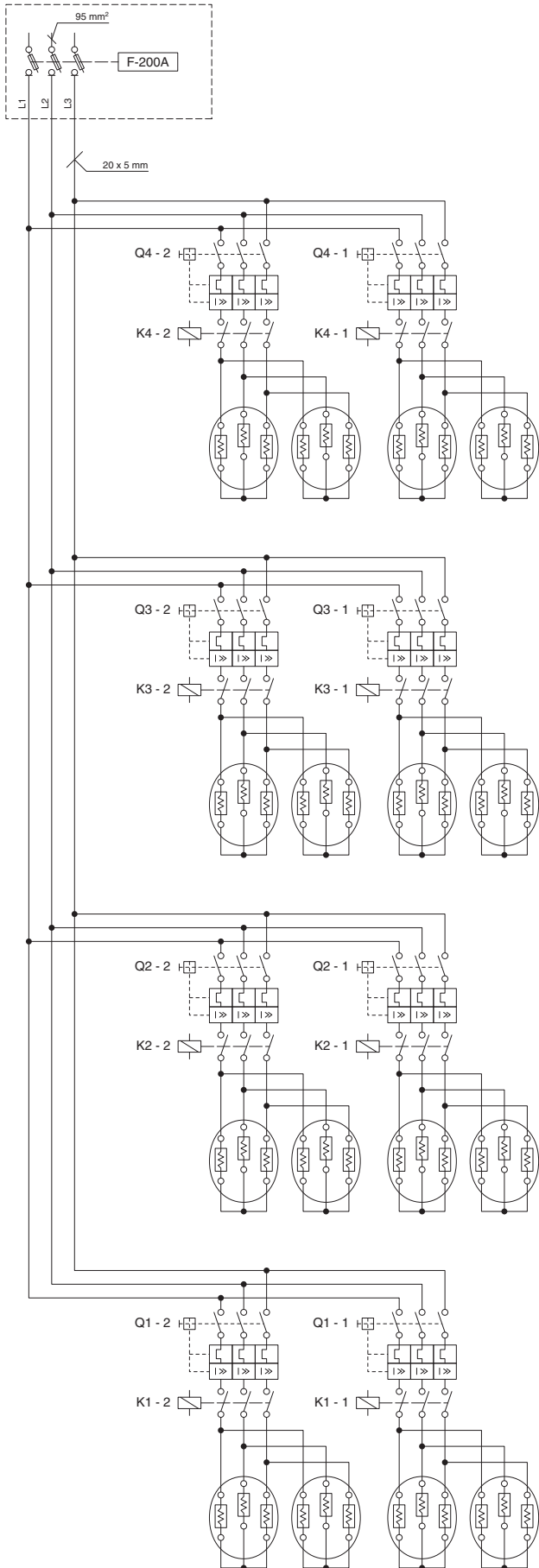

INSTALLATION : ELECTRIC SUPPLY

POWER WIRING / MODEL : E-TECH P / 144

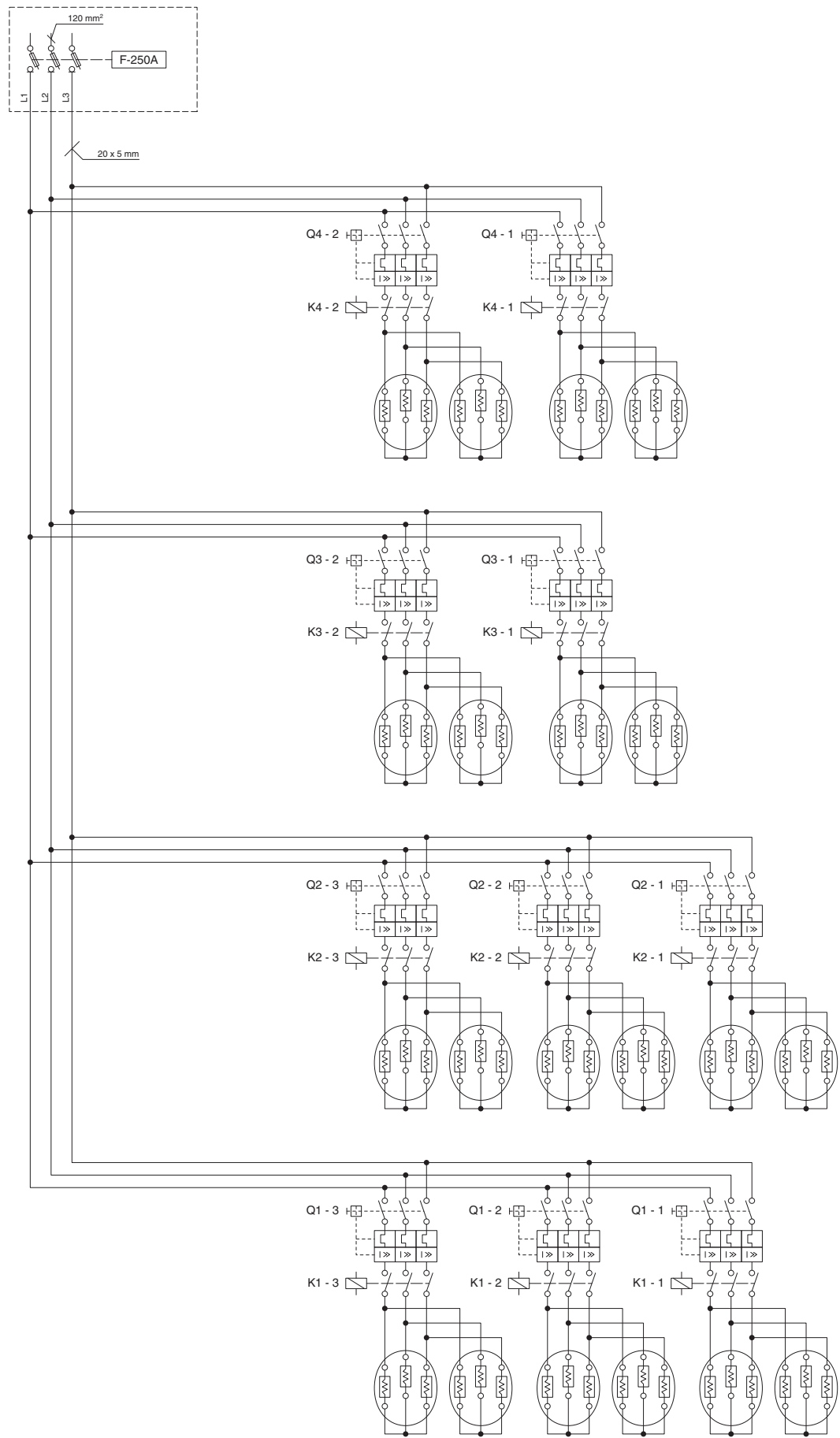
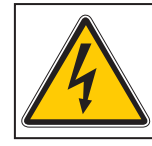

INSTALLATION : ELECTRIC SUPPLY

POWER WIRING / MODEL : E-TECH P / 144

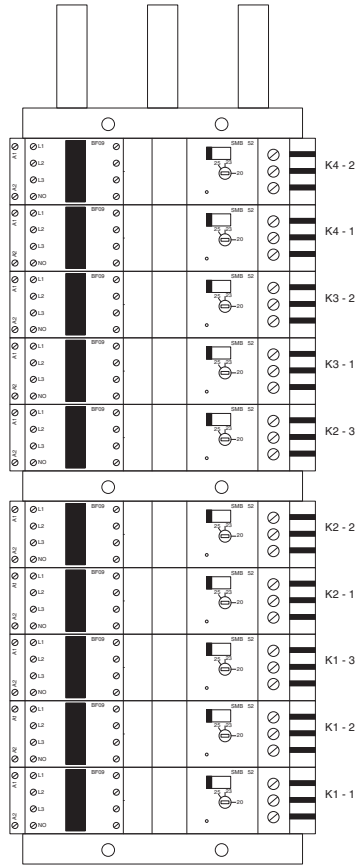
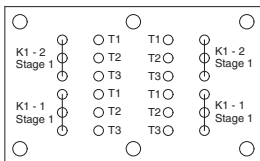
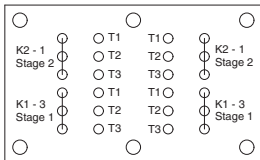
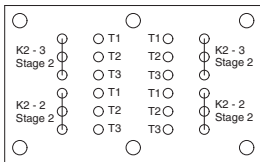
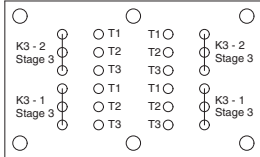
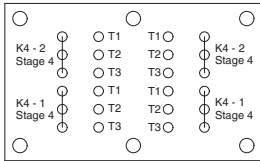

INSTALLATION : ELECTRIC SUPPLY

POWER WIRING / MODEL : E-TECH P / 201

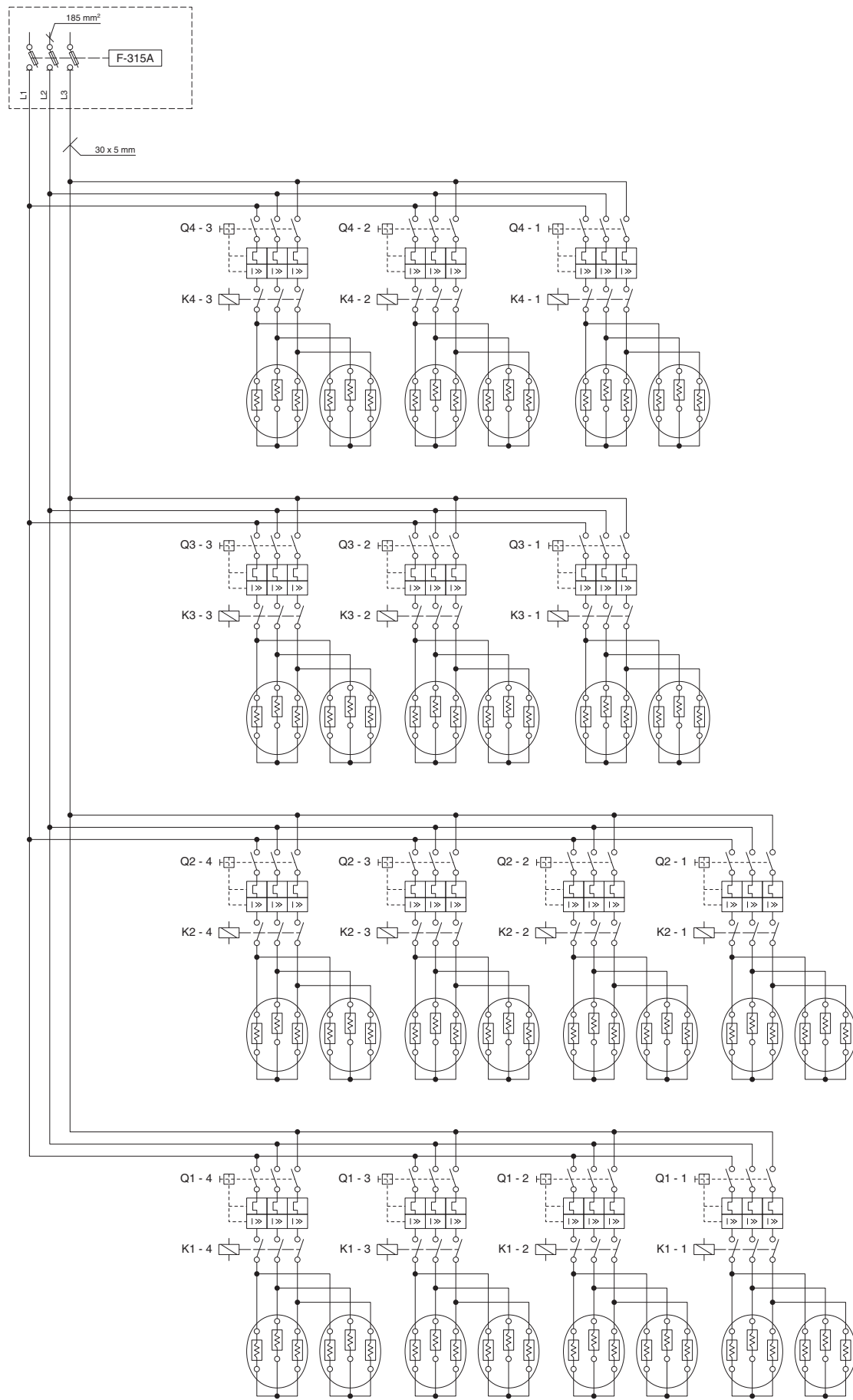

INSTALLATION : ELECTRIC SUPPLY

POWER WIRING / MODEL : E-TECH P / 201

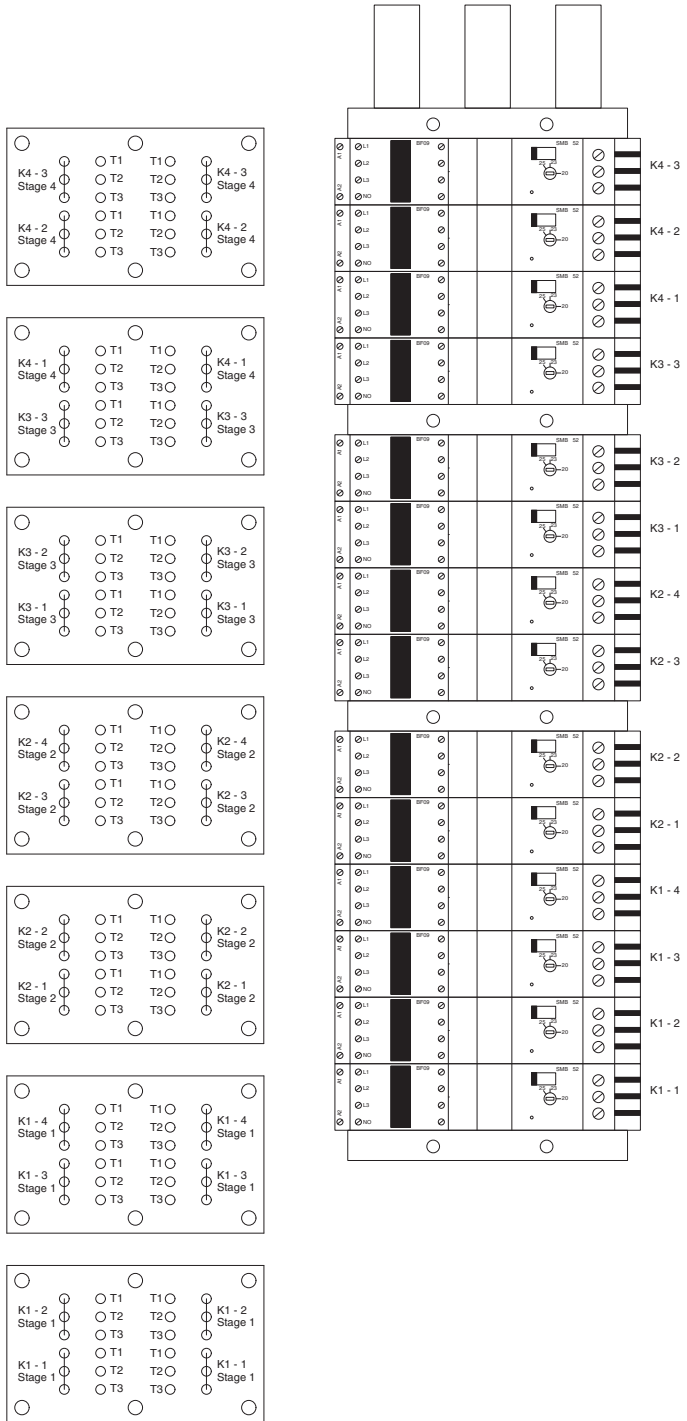

ENGLISH

FRANCAIS

NEDERLANDS

ESPAÑOL

ITALIANO

DEUTSCH

INSTALLATION : ELECTRIC SUPPLY

POWER WIRING / MODEL : E-TECH P / 259

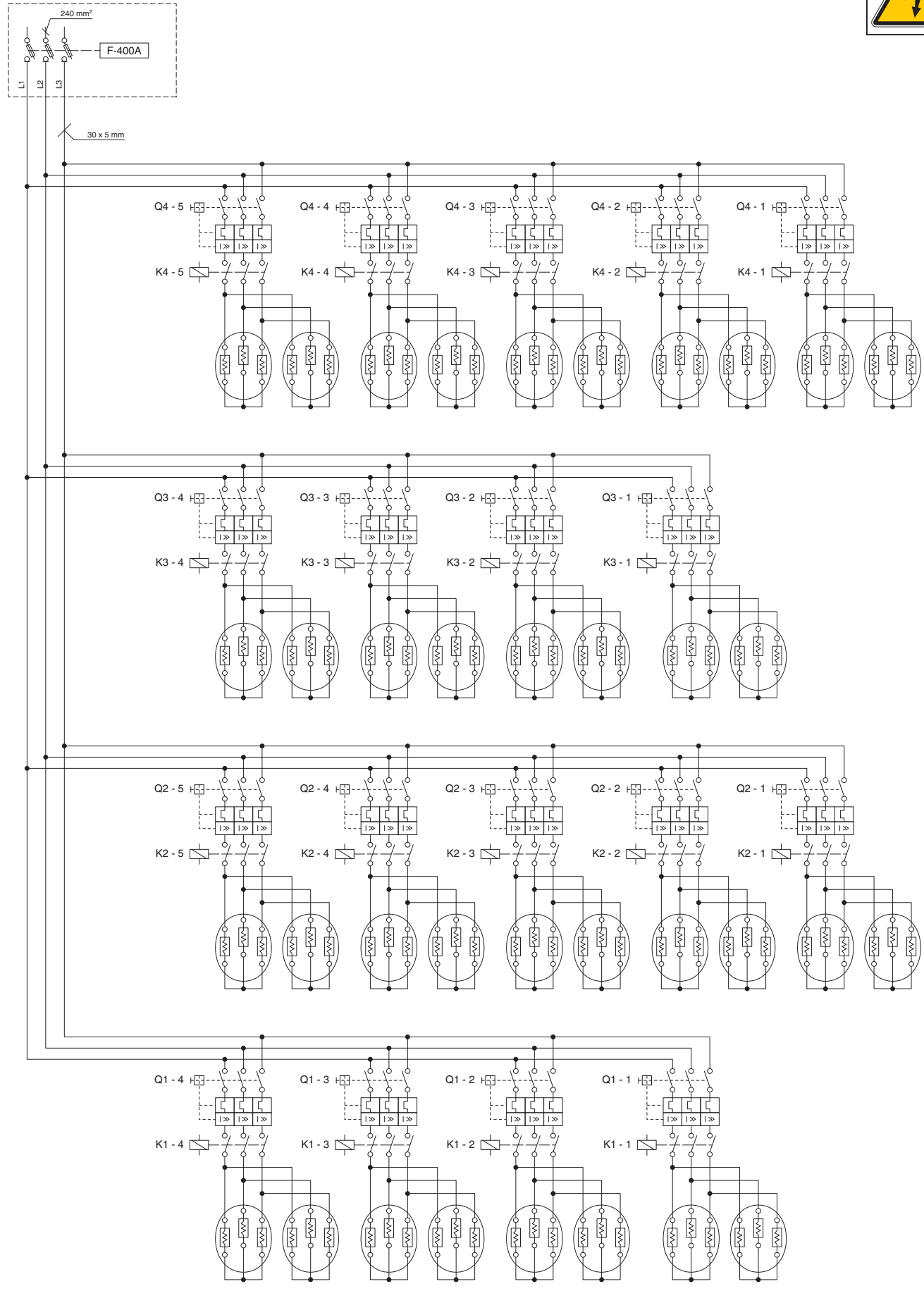

INSTALLATION : ELECTRIC SUPPLY

POWER WIRING / MODEL : E-TECH P / 259

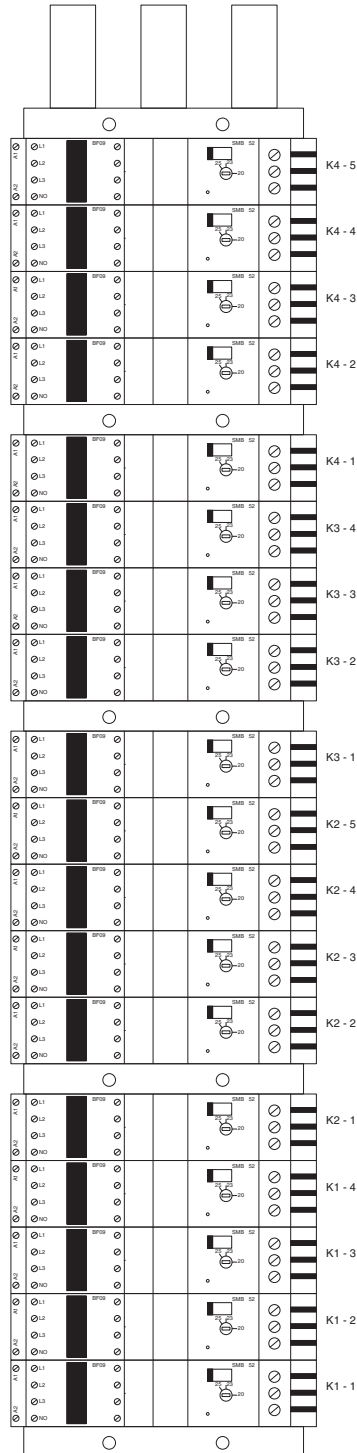
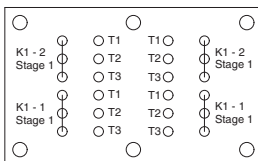
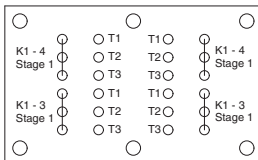
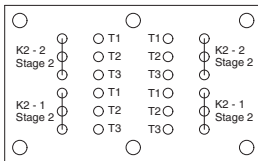
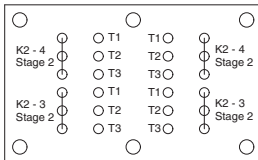
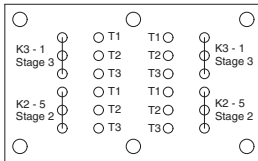
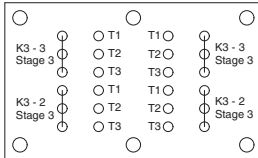
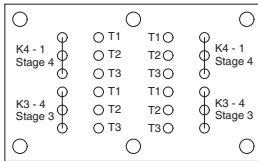
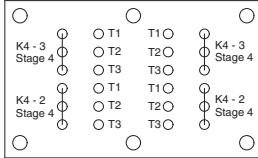
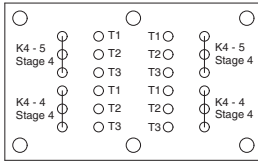

COMMISSIONING

COMMISSIONING - WATER

1. The system must be thoroughly flushed prior to connection of the boiler. The system water should be treated to prevent general corrosion and deposition of scale or sludge in the boiler. If installing the boiler onto an existing system, ACV recommend that an approved system cleaner is used.
2. Fill and pressurise the boiler and system to 1.5 bar, making sure to vent the boiler via the automatic air vent on top of the boiler. Note that the black dust cap on the air vent should be left loose to allow the auto vent to function.
3. Check for leaks.

COMMISSIONING - ELECTRICAL

The Electrical installation supplying this boiler must conform to the current IEE Regulations.

1. Remove the front and the right-hand side. Check all electrical connections for tightness.
2. Ensure all internal relays, contactors etc are secure on the DIN rails.
3. Set panel control main switches to off.
4. Set internal MCB to off position.
5. Set the control thermostat to desired temperature.

STARTING THE BOILER

1. Switch on internal MCB
2. Fit and secure all panels
3. Switch on local isolator to boiler
4. Turn the boiler on using the ON/OFF switch
5. The first stage energises as indicated by the panel light. The temperature will now rise as indicated by the combined temperature and pressure gauge. As long as the control thermostat set-point is not reached, the next stage is energised every 2 minutes until all the stages are energised. When the control thermostat set-point is reached, the last stage is de-energized every 30 seconds until all the stages are de-energized.

Once these procedures have been followed the system can be left to operate normally.



After one week of operation all electrical connections should be re-checked. The fixing nuts must of the heating elements must be re-tightened at the nominal torque of 10 Nm following the tightening sequence mentioned in maintenance section.

MAINTENANCE

For safety reasons it is recommended that the boiler is serviced annually and that servicing is carried out by a qualified service engineer.

 **Before carrying out any work on the system ensure that the boiler is cool and all electrical supplies are isolated.**

1. After removing the front and the right panels, Undertake a visual inspection of the boiler checking for signs of water leakage from gaskets, and the components on top of the boiler.
2. Undertake a visual inspection of all wiring in the boiler casing checking for signs of overheating or burning.
3. Check all push-on electrical connectors for tightness and good connection to the relative components.
4. Using a correct fitting screwdriver check all electrical terminals on DIN rails and on all components for tightness.
5. **Re-tight the fixing nuts of the heating element at nominal torque of 10 Nm following the tightening sequence.**
6. Check all individual circuit breakers are in the normal position. If some fuses have tripped, check the wiring and the resistance before reactivating them.
7. **Replacement of the heating element (if required).**

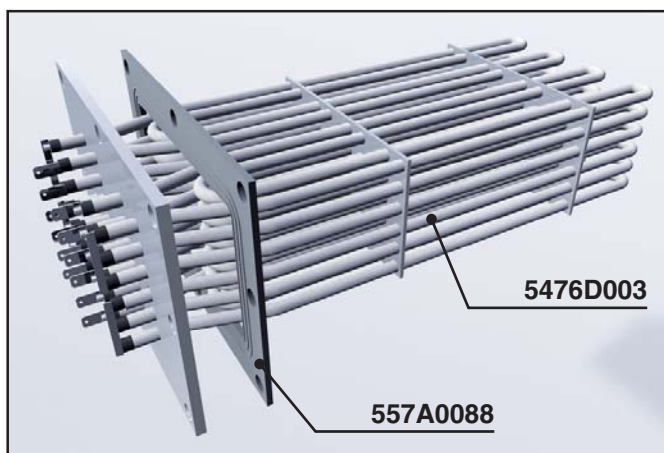

Ohmic value : 22 Ω

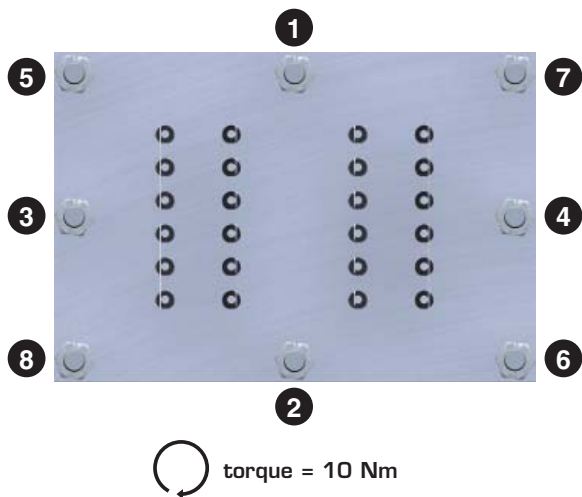

 torque = 10 Nm



Please follow the tightening sequence

7. Replacement of the main fuses (if required)

Models	Fuses	ACV code
E-Tech P / 57	100 A	5476C006
E-Tech P / 115	200 A	5476C007
E-Tech P / 144	250 A	5476C008
E-Tech P / 201	315 A	5476C009
E-Tech P / 259	400 A	5476C010

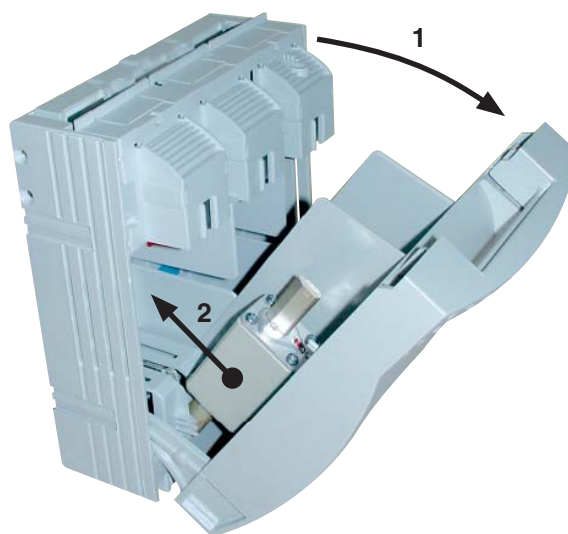

8. Fit the right-hand panel and the boiler front cover and refit screws.
9. Switch ON the electrical supply and following the procedures described in the commissioning section.



Before opening any cover and/or caring and any work on the system, ensure that the system is electrically disconnected from the power supply.



Handwriting practice area with multiple sets of horizontal lines (solid top and bottom lines with a dotted midline) for text entry.