

# Prestige

50 - 75

## *Installation, Operating and Servicing Instructions*

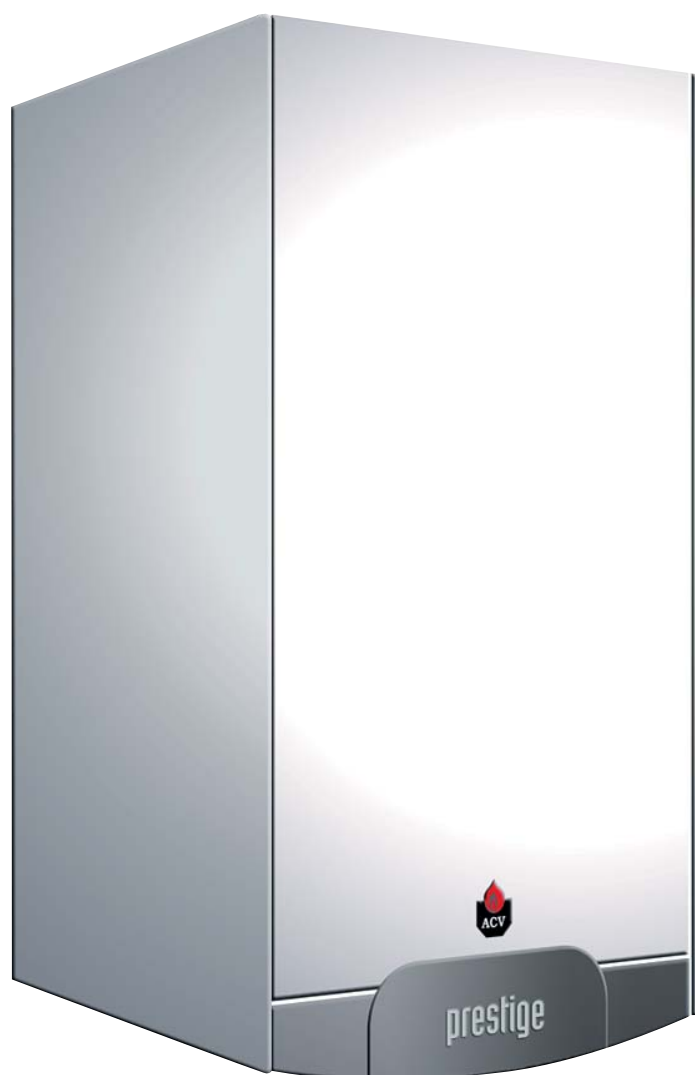

# INDEX

<b>WARNING</b>	<b>3</b>
Who should read these instructions	3
Symbols	3
Recommendations	3
Applicable standards	3
Warnings	3
<b>INTRODUCTION</b>	<b>4</b>
Description of the specifications	4
<b>USERS GUIDE</b>	<b>5</b>
Directions for use	5
Settings the parameters	5
<b>TECHNICAL CHARACTERISTICS</b>	<b>6</b>
Natural gas categories	7
Propane gas categories	7
Pressure drop diagram of the boiler	7
<b>ELECTRICAL CONNECTION</b>	<b>8</b>
Wiring diagram	8
<b>INSTALLATION INSTRUCTIONS</b>	<b>9</b>
Dimensions	9
Boiler room	9
Wall mounting of the boiler	9
<b>INSTALLATION</b>	<b>10</b>
Connection to the chimney	10
Connection to the gas	11
Heating connections	11
Installation of simple heating circuit controlled by room thermostat ACV 15	12
Installation of simple heating circuit controlled by Room Unit	13
Installation of two heating circuits controlled by room thermostat ACV 15 and AM3-11 module	14
Installation of two heating circuits controlled by Room Unit and ZMC-1 module	16
Installation of three heating circuits controlled by Control Unit	18
Domestic hot water connection	19
<b>COMMISSIONING AND MAINTENANCE</b>	<b>20</b>
Commissioning the system	20
Inspection and maintenance	20
Disassembling the burner	21
Disassembling and checking the electrode	21
Disassembling the heat exchanger	21
Cleaning the heat exchanger	21
Temperature sensor resistance tables	21
<b>MCBA PARAMETERS FOR THE SPECIALIST</b>	<b>22</b>
Standby Mode	22
Settings the MCBA parameters	23
Request for information on the installation	24
Entering the code	24
MCBA parameters with code restricted access	25
Communication Mode	28
Error Mode	28
Safety stop + resolution of the fault	29
<b>SPARE PARTS</b>	See at the end of this manual

# WARNINGS

## WHO SHOULD READ THESE INSTRUCTIONS

These instructions should be read by:

- the specifying engineer
- the installer
- the user
- the service engineer

## SYMBOLS

The following symbols are used in this manual:



Essential instruction for the correct operation of the installation.



Essential instruction for the safety of persons and the environment.



Danger of electrocution.

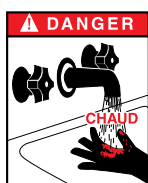

Danger of burns

## RECOMMENDATIONS



- Please, read carefully this manual before installing and commissioning the boiler.
- It is prohibited to carry out any modifications to the inside of the appliance without the manufacturer's prior and written agreement.
- The product must be installed and serviced by trained engineers, in compliance with current standards.
- Any failure to follow instructions relating to tests and test procedures may result in personal injury or risks of pollution.
- To guarantee safe and correct operation of the appliance, it is important to have it serviced and maintained every year by an approved installer or maintenance company.
- In case of anomaly, please call your service engineer.
- Despite the strict quality standards imposed by ACV during the manufacture, inspection and transport of its appliances, you might notice some errors. Please report immediately any fault to your approved installer. Remember to note the fault code displayed on the screen.

- The parts may only be replaced by genuine factory parts. You will find a list of the spare parts and their reference number ACV to the end of this document.
- The burners are preset in our factory for use with natural gas [equivalent to G20].
- Specific regulation applicable in Belgium: The CO<sub>2</sub> level, the air and gas flows and the gas / air ratio are factory set. Any field adjustments of those settings is not allowed in Belgium.



- It is important to switch the boiler off before carrying out any work.
- There are no user accessible parts inside the boiler casing.

## APPLICABLE STANDARDS

The appliances carry the CE mark in accordance with the standards in force in the various countries (European Directives 92/42/EC "Efficiency", 90/396/EC "Gas appliances"). They also carry the "HR-TOP" label (Gas condensation boilers).



## WARNINGS

### IF YOU SMELL GAS:

- Immediately shut off the gas intake.
- Open windows for fresh air flowing.
- Do not use any electrical appliances and do not actuate any switches.
- Immediately notify your gas supplier and/or your installer.

This documentation is part of the information delivered with the appliance and must be given to the user and stored in a safe place!

An approved installer must carry out the assembly, commissioning, maintenance and repair of the system, in accordance with current standards in force.

ACV shall not accept any responsibility for damage caused by noncompliant location of the system or by use of the parts or connections not approved by ACV for this application.



The manufacturer reserves the right to change the technical characteristics and specification of its products without notice.



The availability of some versions and their accessories is market dependant.

# INTRODUCTION

## DESCRIPTION OF THE SPECIFICATIONS

The **Prestige** is a wall-mounted condensing boiler meeting the requirements of the "HR-Top" applicable standards applicable in Belgium. The boiler is certified compliant with EC standards as a connected appliance: **C13(x)** - **C33(x)** - **C43(x)** - **C53** - **C83(x)**, but it can also be connected as an open appliance in category **B23**.

## LINING

The boiler is protected by a steel lining that first of all undergoes a degreasing and phosphating process before being lacquered and heated at 220°C. The inside of this lining is coated with a layer of thermal and acoustic insulation, reducing losses to a minimum.

## HEAT EXCHANGER

The core of the **Prestige** features a new stainless steel heat exchanger. This piece of technology represents the fruit of exhaustive research and intensive laboratory testing. It reflects ACV's eighty years of experience in using stainless steel for heating and hot water functions. The particular geometry of the exchanger pipes is calculated to obtain a very large Reynolds number throughout its cycles.

The **Prestige** achieves an exceptional output that remains stable throughout the boiler's life, given that it causes no oxidation on the exchanger, which is manufactured entirely from quality stainless steel.

## BURNER

ACV uses its BG 2000-M burner for the **Prestige**: this is an air/gas premix burner providing safe and silent operation while limiting emissions (NOx and CO) to an incredibly low level. Although the ACV BG 2000-M boiler is very modern, it uses proven technology and is manufactured from standard spare parts that are easily available on the market.

## TEMPERATURE REGULATION

The basic version of the Prestige is fitted with a microprocessor controlled regulator (MCBA) which takes over both the safety functions (ignition, monitoring the flame, limiting the temperature, etc.) and control of the boiler temperature.

This MCBA also includes a weather-dependent regulator. All you need to do is connect the outdoor temperature sensor available as an option to the device. However, this regulator can also operate with a standard on/off room thermostat. In addition, with the combination of a weather-dependent regulator and a room thermostat, you can control the temperatures based on the weather with compensation for the indoor temperature.

There are four user adjustable parameters. By entering a special maintenance code, qualified installers can access several other parameters to adapt the boiler to special requirements. In principle, these parameters are factory set for all normal applications.

## PRODUCTION OF HOT WATER

- **Prestige 50 / 75 Solo** : is custom-designed to operate for heating only or in combination with the whole range of ACV water tanks. The SmartLine range is the number one choice for domestic applications.

## FROST PROTECTION

The boiler is equipped with an integrated frost protection: as soon as the NTC1 flow temperature drops below 7°C, the system activates the central heating pump. As soon as the NTC1 flow temperature drops below 3°C, the system automatically ignites the burner until the temperature rises above 10°C. The pump continues to run for about 10 minutes.

If an outdoor temperature sensor is connected to the system, the pump is activated as soon as the outside temperature drops below the specified threshold.

To provide efficient protection for the whole system against frost, all the valves on the radiators and the convectors should be completely open.

## Description of the boiler

1. Burner, premix and modulating
2. Manual air vent
3. Heat exchanger, stainless steel
4. Water pressure safety switch
5. Chimney connection concentric tubes Ø 100/150 mm
6. Flue tube
7. Gaz pressure safety switch
8. Electrical panel
9. Control panel

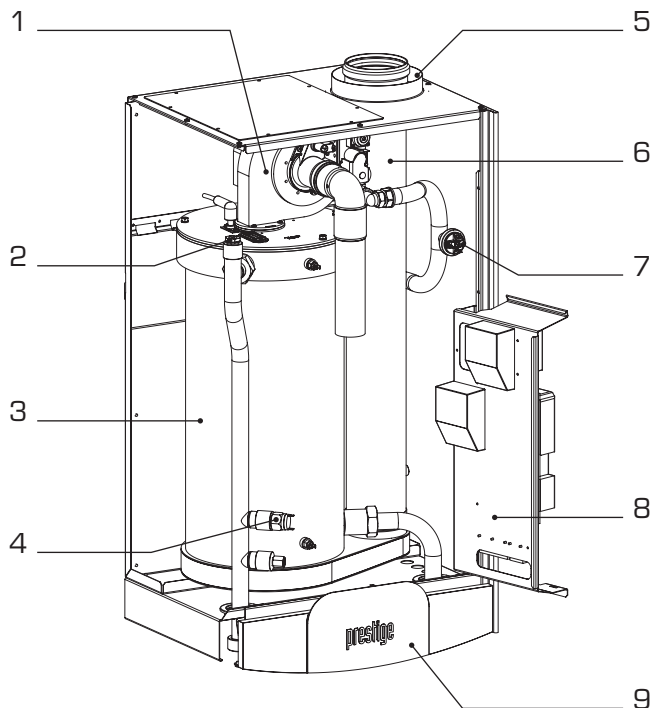

## DIRECTIONS FOR USE

Your system must be checked once a year by an approved installer or maintenance company.

### Starting the burner

During operation, the burner starts automatically as soon as the boiler temperature drops under the required set point and it stops as soon as the boiler reaches that temperature.

### Control panel



### Heating system

The central heating circuit must be pressurized (see in the chapter "Installation" how to define the system pressure). The pressure indicator is located on the right-hand side of the display.



**If your system needs to be refilled more than twice a year, please contact your installer.**

The CH pressure must be a minimum of 1 bar and must be checked by the end user on a regular basis. If the pressure drops under 0.5 bar, the integrated water pressure switch blocks the appliance until the pressure in the system returns to a level above 0.8 bar. The connection for a fill valve is provided underneath the appliance. The installer can also fit the system with a separate valve. Make sure that the appliance is powered off when filling the system. To do this, toggle the Start/Stop switch located on the left of the screen to Off. (see the Control panel).

For more information, please ask your installer when the system is delivered.

A safety valve is provided at the underneath of the appliance. If the system pressure exceeds 3 bars, this valve opens and drains the water from the system. In this case, please contact your installer.

## SETTING THE PARAMETERS



Also see the user label located inside the valve on the control panel:

### Setting the domestic hot water temperature

(Hot water temperature)

- Press **Mode**: The screen displays **PARA**.
- Press **Step**: the first character is **1** and the last two characters give the current hot water temperature setting.
- To change this temperature, press + or - until the last two digits show the desired temperature value.
- Press **Store** to save the new temperature setting.
- Press **Mode** twice to return to Pilot mode (normal operating mode).

### Enabling or disabling the hot water heating mode (hot water)

- Press **Mode**: The screen displays **PARA**.
- Press **Step** twice: the first character is **2** and the last two characters give the current setting:  
**00** = disabled; **01** = enabled.
- To change this parameter, press + or - until the screen displays the desired value:  
**00** = disabled; **01** = enabled.
- Press **Store** to save.
- Press **Mode** twice to return to Pilot mode (normal operating mode).

### Enabling or disabling Central Heating mode:

(heating)

- Press **Mode**: The screen displays **PARA**.
- Press **Step** three times: the first character is **3** and the last two characters give the current setting:  
**00** = disabled; **01** = enabled.
- To change this parameter, press + or - until the screen displays the desired value:  
**00** = disabled; **01** = enabled.
- Press **Store** to save.
- Press **Mode** twice to return to Pilot mode (normal operating mode).

### Setting the central heating temperature:

(maximum temperature for the heating circuit)

- Press **Mode**: The screen displays **PARA**.
- Press **Step** four times: the first character is **4** and the last two characters give the current central heating temperature setting.
- To change this temperature, press + or - until the last two digits show the desired temperature value.
- Press **Store** to save the new temperature setting.
- Press **Mode** twice to return to Pilot mode (normal operating mode).

### Fault:

The temperature setting for the appliance and the safety functions for its various parts are continuously monitored by a regulator controlled by a microprocessor (the MCBA). In the event of a fault, this MCBA disables the appliance and displays an error code: the screen flashes displaying **E** as the first character, followed by the error code.

To reset the appliance:

- Press **"Reset"** on the screen.
- Contact your installer if the fault happens again.

# TECHNICAL CHARACTERISTICS

Central heating		Natural gas		Propane gas	
		50	75	50	75
Max [intake] pressure	kW	49,9	72	49,9	72
Min. [intake] pressure	kW	15	18,3	15	18,3
Max output 80/60°C	kW	48,4	69,9	48,4	69,9
Min. output 80/60°C	kW	14,7	17,9	14,7	17,9
Efficiency at 30% load [EN677]	%	107,8	107,8	107,8	107,8

## Flue gases

CO emissions max. / min. Input	mg/kWh	45 / 20	52 / 20	89 / ??	118 / 37
NOx emissions [EN483]	mg/kWh	66 / 30	62 / 38	70 / 53	71 / 60
NOx classification [EN483]		5	5	5	5
Flue gas temperature — max. Input 80/60°C	°C	82	82	80	80
Flue gas temperature — max. Input 50/30°C	°C	40	40	39	39
Mass flow rate of combustion products	kg/h	79	115	79	115
Flue gas pipe - Max. pressure drop	Pa	150	150	150	150
Concentric flue gas channel maximum length Ø 100 / 150 mm	m	20	20	20	20

Gas		G20 / G25		G31	
		I 2E[S]B — I 2Er — I 2H — I 2 HS I 2ELL — I 2L — I 2E		I 3P — I 3+ — I 3B	
Category [varies by country]					
Gas pressure	mbar	20 / 25		30 / 37 / 50	
G20 gas flow rate	m³/h	5,28	7,6	•	•
G25 gas flow rate	m³/h	6,14	8,8	•	•
G31 gas flow rate	m³/h	•	•	2,0	2,9
CO <sub>2</sub> max. Input G20/25 (with front panel closed)	% CO <sub>2</sub>	9,4	9,4	10,8	10,8
CO <sub>2</sub> max. Input G20/25 (with front panel open)	% CO <sub>2</sub>	9,2	9,2	10,5	10,5
CO <sub>2</sub> min. Input G20/25 (with front panel closed)	% CO <sub>2</sub>	9,3	9,3	10,4	10,4

## Hydraulic parameters

Max. operating temperature	°C	90	90	90	90
Boiler water capacity	L	20	17	20	17
Maximum operating pressure central heating	bar	3	3	3	3
Heat exchanger pressure drop [ΔT = 20°C]	mbar	30	74	30	74

## Electrical connection

Class	IP	30	30	30	30
Supply voltage	V/Hz	230 / 50	230 / 50	230 / 50	230 / 50
Maximum absorbed electrical power	A	0,8	1,1	0,8	1,1

<b>Weight (empty)</b>	<b>kg</b>	54	58	54	58
-----------------------	-----------	----	----	----	----

# TECHNICAL CHARACTERISTICS

Natural gas categories		BE	FR	NL	LU	DE	AT - CH - CZ - DK - ES - IT FI - UK - IE - PT - SE - GR	HU
I 2 E(S)B	G20 / 20 mbar – G25 / 25 mbar	●						
I 2 Er	G20 / 20 mbar – G25 / 25 mbar		●					
I 2 L	G25 / 25 mbar			●				
I 2 E	G20 / 20 mbar				●			
I 2 ELL	G20 / 20 mbar – G25 / 20 mbar					●		
I 2 H	G20 / 20 mbar						●	
I 2 HS	G20 / 25 mbar							●

Propane categories		DK - NL NO - IT	BE - CH - ES FR - UK - IE PT - FI - SE IT - GR	AT - CH CZ - ES NL - DE LU - HU	BE - CH ES - FR UK - IE IT - PT	PT	CZ - DK - ES FI - FR - UK IE - IT - NL NO - PT - SE	AT - CH CZ - DE FR
I 3P	[G31] 30 mbar	●						
I 3P	[G31] 37 mbar		●					
I 3P	[G31] 50 mbar			●				
I 3+	[G30 + G31] 28 - 30 / 37 mbar				●			
I 3+	[G30 + G31] 50 / 67 mbar					●		
I 3B	[G30] 28 / 30 mbar						●	
I 3B	[G30] 50 mbar							●

## PRESSURE DROP DIAGRAM OF THE BOILER

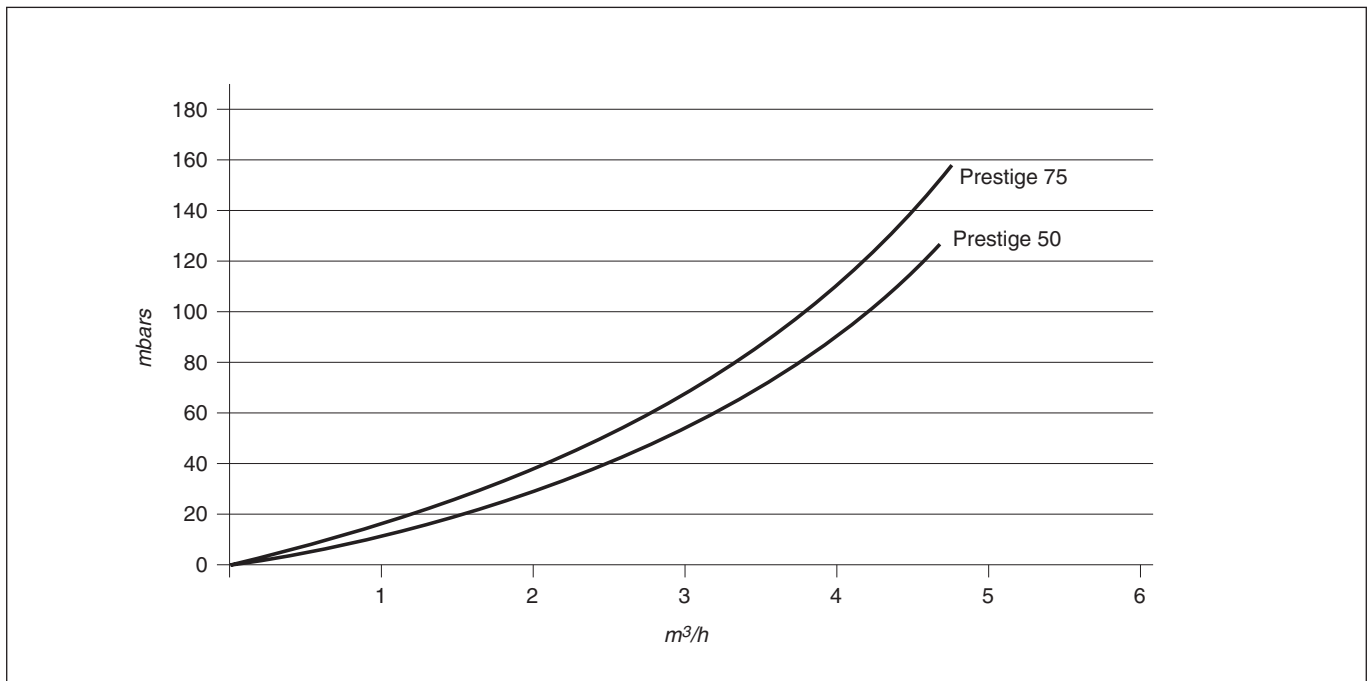

# ELECTRICAL CONNECTION

## WIRING DIAGRAM : PRESTIGE 50 - 75



- |                                       |   |
|---------------------------------------|---|
| 1. 230V connection cord               | 12. PWM connector on the blower                             |
| 2. ON/OFF switch                      | 13. NTC1 flow sensor  |
| 3. Heating pump (optional)            | 14. NTC2 return sensor                                      |
| 4. Domestic hot water pump (optional) | 15. NTC5 flue gas temperature sensor                        |
| 5. Burner                             | 16. Room thermostat (optional)                              |
| 6. Gas valve                          | 17. NTC3 domestic hot water sensor (optional)               |
| 7. 230 - 24Volt transformer           | 18. NTC4 outdoor temperature sensor (optional)              |
| 8. MCBA burner control                | 19. NTC6 temperature sensor on second CH circuit (optional) |
| 9. Display                            | 20. Zero volt of 24V circuit.                               |
| 10. Gas pressure safety switch        | 21. Safety thermostat RAM (optional)                        |
| 11. Water pressure safety switch      | 22. Ionisation and ignition cable                           |

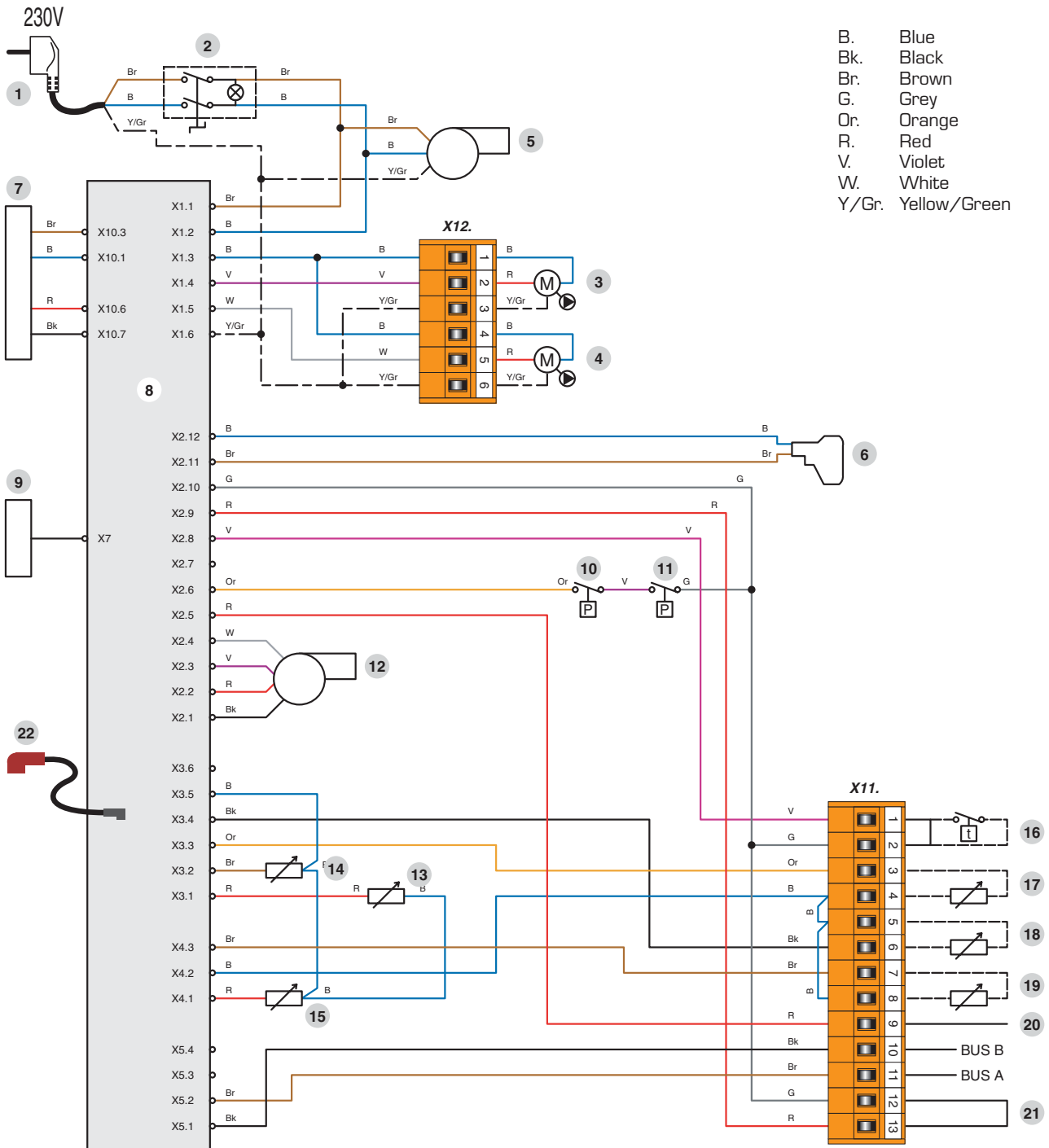



# INSTALLATION INSTRUCTIONS

## DIMENSIONS

50 / 75

A mm	980
B mm	500
C mm	392
D mm	100
E mm	150
F mm	175
G mm	930
H mm	400

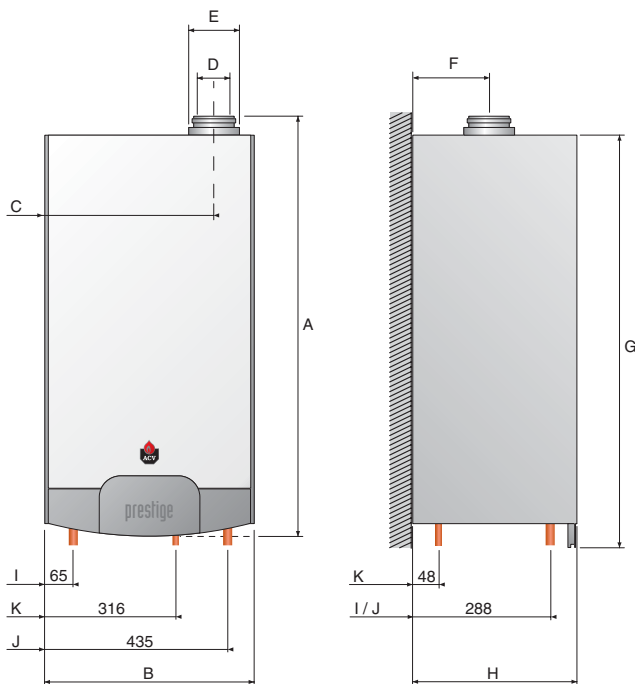

- I. Heating supply 1"1/4 [F]
- J. Heating return 1"1/4 [F]
- K. Gas connection 3/4" [M]

## BOILER ROOM

- Make sure that all air vents are unobstructed any times.
- Do not store any flammable products in the boiler room.
- Do not store any corrosive products, paint, solvents, salts, chlorine products and other detergent products near the appliance.
- If you smell gas, do not switch on any lights, turn off the gas tap at the meter, ventilate the rooms and contact your installer.

## ACCESSIBILITY

The appliance must be positioned in such a way to be accessible any time. In addition, the following distances are required around the appliance.

## WALL MOUNTING OF THE BOILER

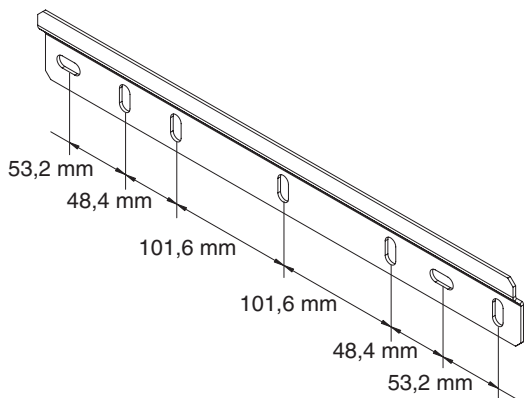

- The boiler must be mounted on a non-flammable wall.
- Drill two 10 mm diameter holes, spaced as indicated on the above drawing.
- Secure the wall-mount bracket with the delivered anchor screws.
- Hook the boiler on the bracket.

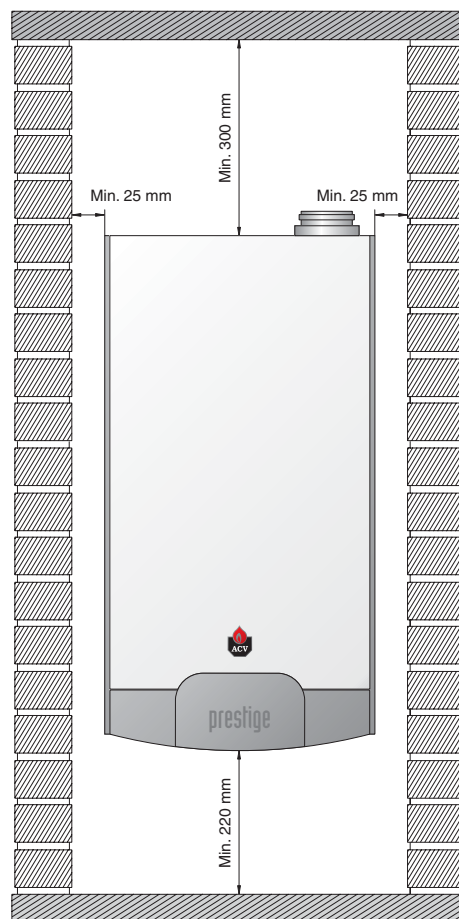

# INSTALLATION

## CONNECTION TO THE CHIMNEY

- The chimney connections must comply with the applicable standards (in Belgium: NBN D51-003), the local energy supplier's instructions, the fire regulation and neighbourhood good practices.
- The **Prestige** has an in built gas/air ratio regulator, which makes it largely independent of the pressure drop in the air intake and flue gas extraction system. However, the maximum pressure drop for this system may not be exceeded, or the pressure will diminish. Nevertheless, the gas/air ratio regulator continuously guarantees optimum combustion with very low emission levels.
- The horizontal flue gas pipes must always be installed with a min. slope of 5 mm per meter, upwards from the boiler side.
- There must be no obstruction or openings for any other appliances within a radius of 0.5 metres around the flue terminal of the **Prestige**.
- **The maximum flue resistance is 150 Pascal.** You can use the following table as the basis for calculating this value (*please also refer to the specimen calculation presented under the table*).

Table of flue resistance in Pascal

[1 Pascal = 0,01 mbar]

	Pipe concentric Ø 100 / 150 mm	Air inlet separate Ø 100 mm	Air extraction separate Ø 100 mm
1 m straight pipe	6	1,7	2,5
Pipe with a monitoring section	3	—	1,3
90° pipe bend	12	5,1	7
45° pipe bend	5,5	2,1	3
Vertical pipe outlet	25	—	—
Horizontal pipe outlet	20	—	—

*This table is based on the equipment offered by ACV and cannot be applied generally.*

## Options for connection to the chimney

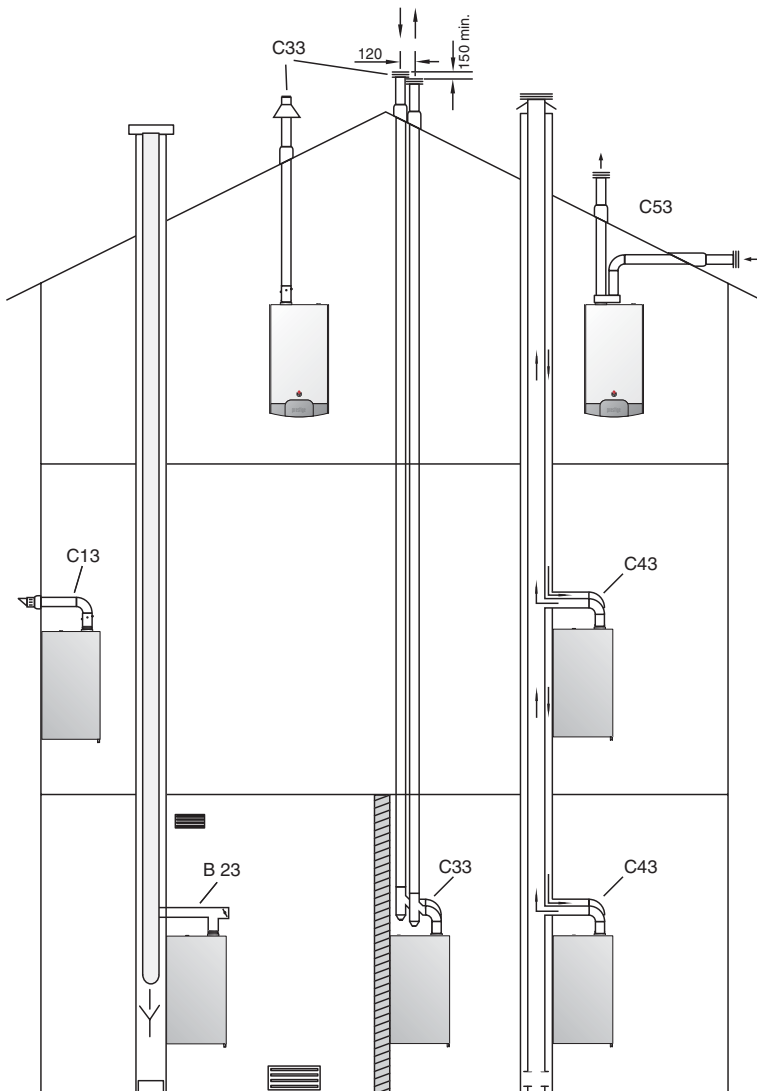

## Sample calculation:

The diagram below consists of the following parts: pipe with monitoring section + 2 \* 90° pipe bends + 2 metres of horizontal pipe + 2 \* 45° pipe bends + (2 + 1 + 1) metres of vertical pipe and fall back + discharge.

Therefore, the resistance of this system is as follows:  $3 + (2 \times 12) + (2 \times 6) + (2 \times 5,5) + (4 \times 6) + 25 = 99 \text{ Pa}$ .

**This value is less than the maximum authorised resistance, therefore the installation is compliant.**

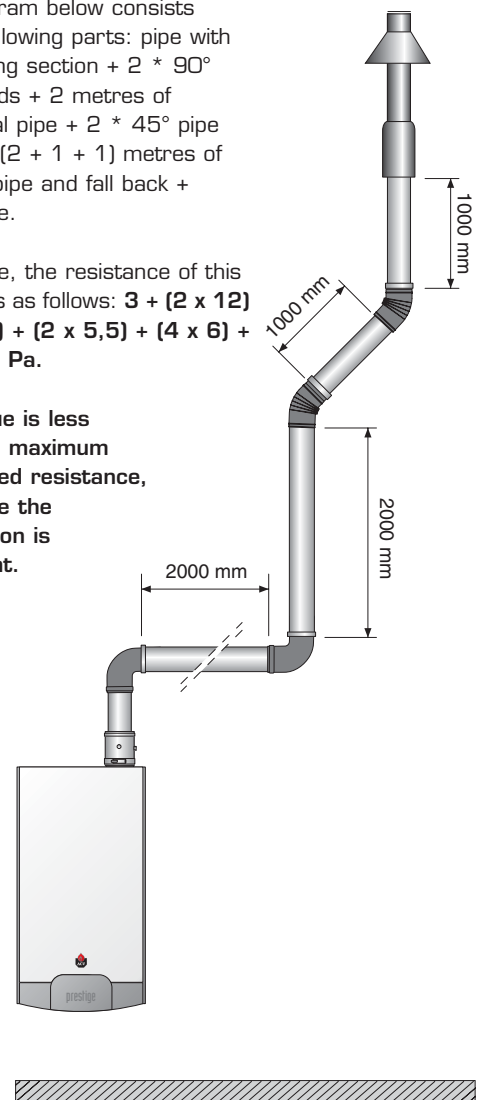

# INSTALLATION

## CONNECTION TO THE GAS

- The **Prestige** is fitted with a 3/4" male fitting connector, on which you can connect the gas tap.
- The gas connection must comply with the applicable regulations (e.g. NBN D51-003 in Belgium) in the country of installation.
- Where there is a risk of dirt stemming from the network, place a gas filter upstream of the connection.
- Drain the gas pipe and check in minute detail that all the boiler pipes, both inside and outside, are sealed.
- Check the gas pressure in the system. Consult the technical characteristics.
- Check the gas pressure and consumption when commissioning the appliance.

## HEATING CONNECTIONS

### Recommendations

- The central heating system must be completely flushed out with tap water before connecting the boiler.
- The device must be levelled, using the provided bracket.
- The operating noises can be increased if the appliance is installed on a wall made of wood or other lightweight construction. Using rubber absorbers can reduce this effect.
- The connections to the central heating system are 1"1/4 male.
- The central heating circuit must be equipped with a safety valve routed to the drain with an open connection (to allow inspection) and with a pump sized in function of the pressure drops of both the circuit and the boiler and in function of the required flow.
- Fill the system with fresh water. Contact your ACV representative about the use of inhibitors.
- The system must be designed to ensure a continuous flow in the boiler. If this flow is not guaranteed, for example if using thermostatic valves, you should install a pressure-dependent bypass in the system.
- Fit the siphon, fill it with tap water and connect the hose to the drain using a connection with an inspection section. Make sure you prevent the freezing of the condensates.

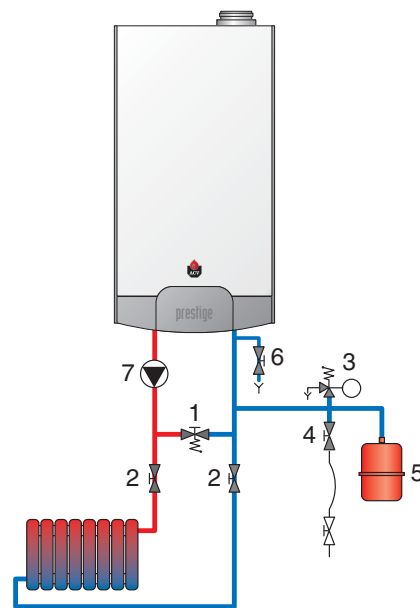

### Example of central heating connection

1. By-pass with differential pressure valve
2. Isolating valve, heating system
3. Safety valve calibrated to 3 bar, with pressure gauge
4. System filling valve
5. Expansion vessel
6. Drain cock
7. Heating pump

# INSTALLATION

## INSTALLATION OF A SIMPLE HEATING CIRCUIT CONTROLLED BY ROOM THERMOSTAT ACV 15

### General diagram

The On/Off room thermostat controls the central heating system (radiators or convectors).

If an outside temperature sensor is connected, the boiler continuously adjusts its operating temperature depending on the outside temperature.

The pump is powered as soon as the room thermostat generates an heat demand.

Advantages for the user:

- Comfort
- Maximum Output
- Simplicity of the system

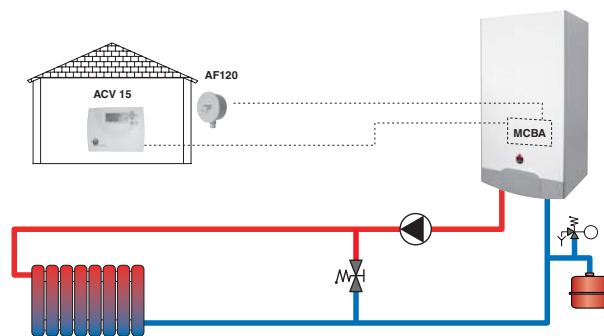

### Optional accessories

Code Description



10800018 Room thermostat ACV 15



10510100 Outside temperature sensor 12kΩ — AF120

Remove this shunt before connecting a room sensor

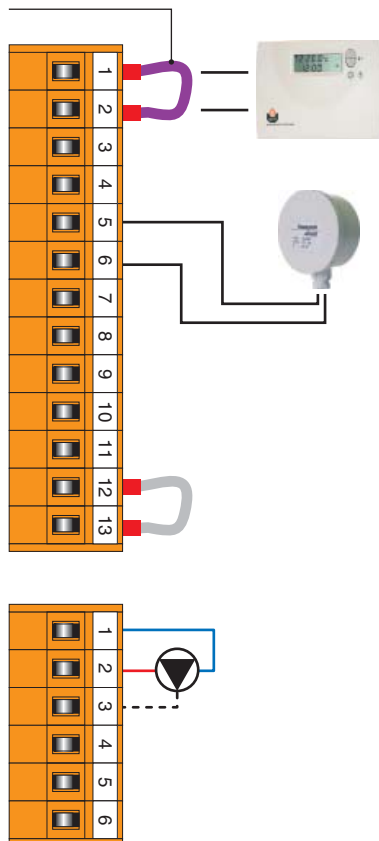

Factory setting	typical setting	Description
3.001	3.001	00 : Heating mode "OFF" 01 : Heating mode "ON"
4.885	4.885	Setting T° for the heating water (adjustable between 30 and 85°C).
P.005	P.005	T° min. for the heating water (adjustable between 15 and 60°C).
2.830	2.830	
P.006	P.006	Minimum outside temperature (adjustable between -20 and 10°C).
2.-10	2.-10	
P.007	P.007	Maximum outside temperature (adjustable between 15 and 25°C).
2.818	2.818	
P.034	P.034	00 : Using a outside temperature sensor and a room thermostat
2.800	2.800	

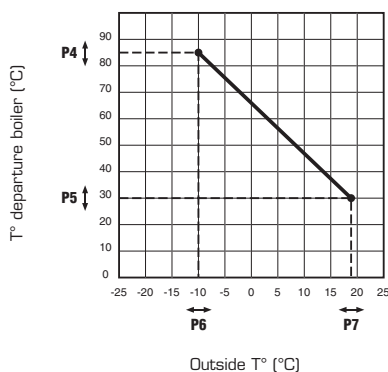

# INSTALLATION

## INSTALLATION OF A SIMPLE HEATING CIRCUIT CONTROLLED BY ROOM UNIT



### General diagram

A Room Unit controls the heating system (radiators or convectors). The unit allows the selection various central heating functions and can be programmed for up to 3 schedules per week, both for heating and hot water production.

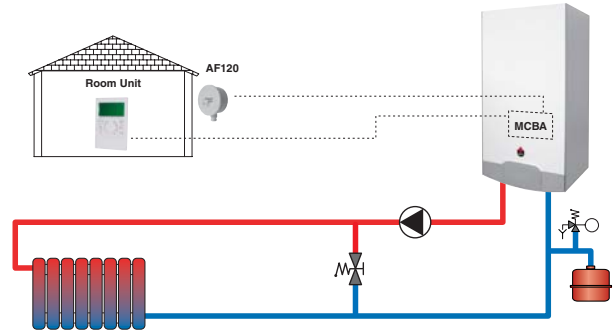
In this configuration, the boiler continuously adjusts its operating temperature in function of the outside temperature.



### Optional accessories

	Code	Description
	10800034	<b>Room Unit RSC</b> Delivered with outside temperature sensor
	10800036	<b>Clip-in interface RMCIEBV3</b> Activates the communication between the MCBA and the Room Unit RSC.
	10510100	<b>Outside temperature sensor 12kΩ — AF120</b>

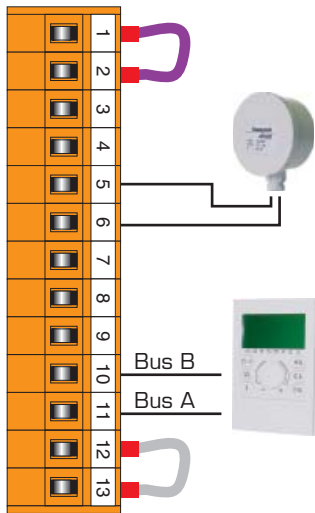

Factory setting	typical setting	Description
PARA	PARA	
3.01	3.01	00 : Heating mode "OFF" 01 : Heating mode "ON"
4.85	4.85	Setting T° for the heating water (adjustable between 30 and 85°C).
P.05	P.05	T° min. for the heating water (adjustable between 15 and 60°C).
1.30	1.30	

10800036: Interface address "0"

<input type="checkbox"/> <input type="checkbox"/> <input type="checkbox"/> = 0	<input type="checkbox"/> <input type="checkbox"/> <input type="checkbox"/> = 4
<input type="checkbox"/> <input type="checkbox"/> <input type="checkbox"/> = 1	<input type="checkbox"/> <input type="checkbox"/> <input type="checkbox"/> = 5
<input type="checkbox"/> <input type="checkbox"/> <input type="checkbox"/> = 2	<input type="checkbox"/> <input type="checkbox"/> <input type="checkbox"/> = 6
<input type="checkbox"/> <input type="checkbox"/> <input type="checkbox"/> = 3	<input type="checkbox"/> <input type="checkbox"/> <input type="checkbox"/> = 7

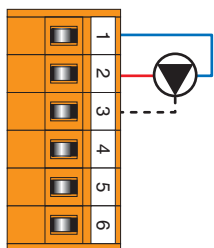

# INSTALLATION

## INSTALLATION OF TWO HEATING CIRCUITS CONTROLLED BY ROOM THERMOSTAT ACV 15 AND AM3-11 MODULE

### General diagram

This is a simple way to control two heating circuits (radiators or floor heating).

You can adjust those two circuits depending on the outside temperature.

This is the ideal configuration for floor heating with additional heating provided by radiators.

The floor heating temperature is adjusted on a first temperature diagram, while the radiator loop follows a second temperature diagram, if needed with a booster function.

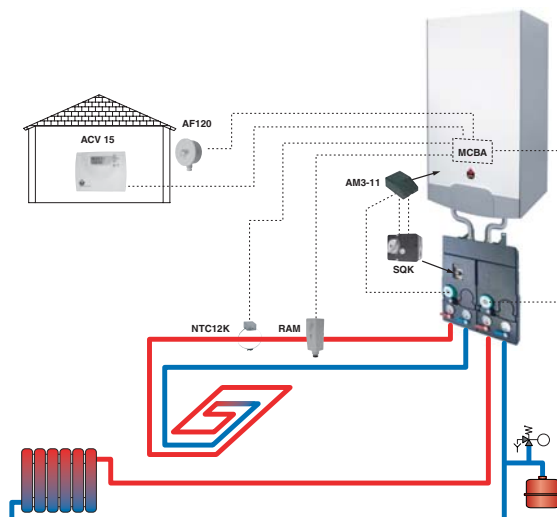

### Optional accessories

Code Description



10800018 Room thermostat ACV 15



10800095 **AM3-11 module :**  
Controls the second heating circuit - communicates directly with the MCBA



537D3040 **Contact sensor 12kΩ**  
To be mounted on the outlet of controlled circuit.



10510900 **Contact thermostat RAM 5109 :**  
Required to protect all floor heating circuits



10510100 **Outside temperature sensor 12kΩ — AF120**



10800104 **Collector 2 circuits DN32 :**  
With integrated wall brackets



10800107 **High temperature kit DN32:**  
Including: one circulation pump, two isolating valves, check valve, two thermometers



10800106 **Low temperature kit DN32:**  
Including: one circulation pump, two isolating valves, check valve, two thermometers, the 3-way valve with integrated bypass.



10800142 **Connection kit DN32 to the manifold:**  
Including: two flexible 1"1/2 hoses and 1"1/4 reduction fittings.



10800019 **Servomotor SQK 349 :**  
Electromechanical servomotor included in low temperature kit.  
(Opening / closing time: 150 sec.)

# INSTALLATION

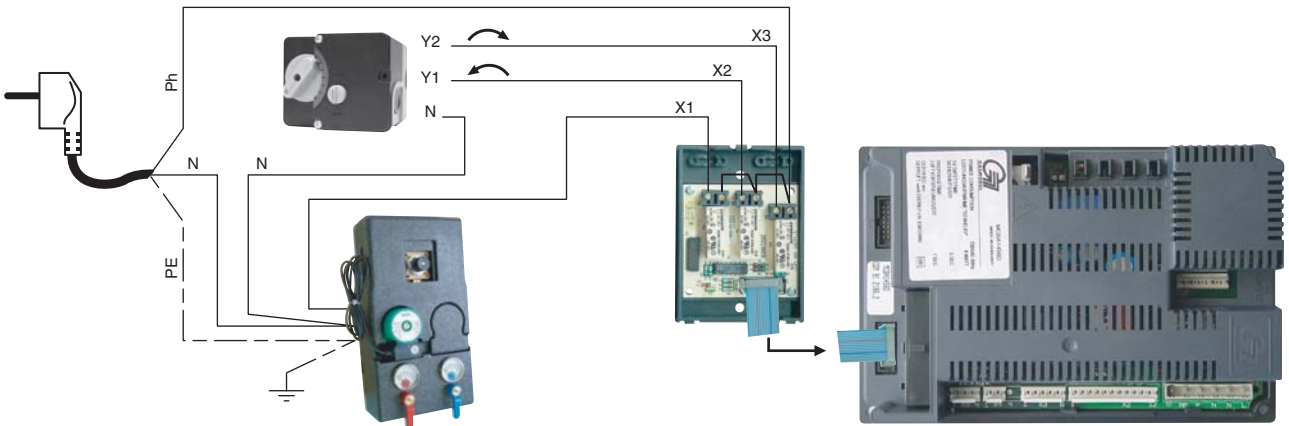
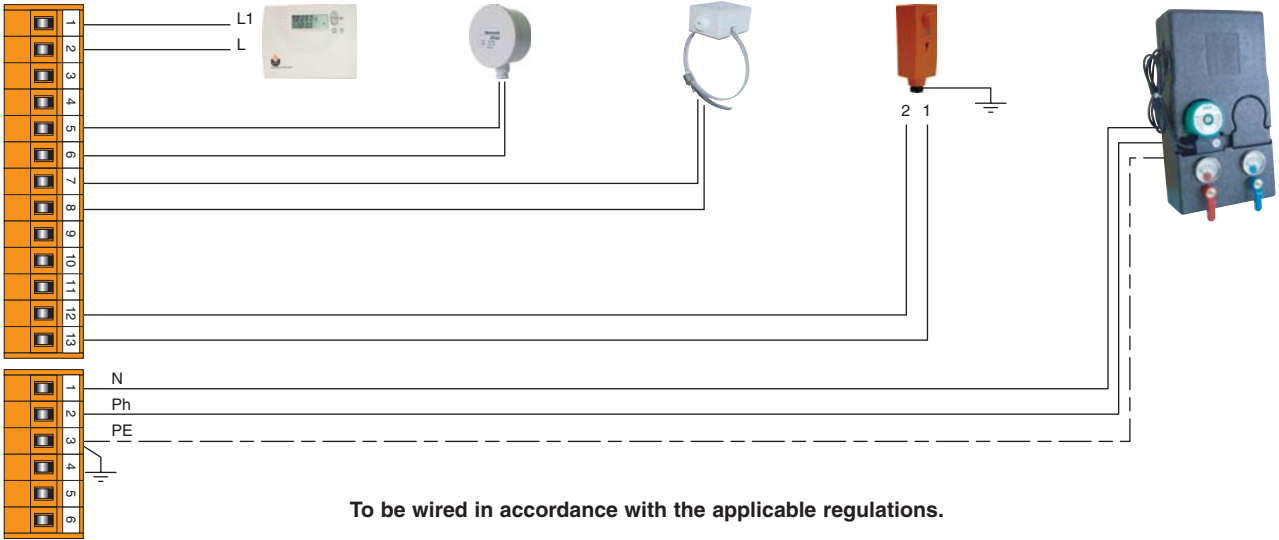

PARA Factory setting	PARA typical setting	Description
3.01	3.01	00 : Heating mode "OFF" 01 : Heating mode "ON"
4.85	4.85	Setting T° for the heating water (adjustable between 30 and 85°C).
P.05 8.30	P.05 8.30	T° min. for the heating water (adjustable between 15 and 60°C).
P.06 -10	P.06 -10	Minimum outside temperature [T4] (adjustable between -20 and 10°C).
P.07 8.18	P.07 8.18	Maximum outside temperature [T4] (adjustable between 15 and 25°C).
P.34 8.00	P.34 8.20	- The high T° circuit is controlled depending on the outside T° and the room thermostat.
P.39 8.50	P.39 8.50	- The low T° circuit is controlled depending the outside T° only.
P.40 8.20	P.40 8.20	Maximum temperature of the second heating circuit
P.40 8.20	P.40 8.20	Minimum temperature of the second heating circuit

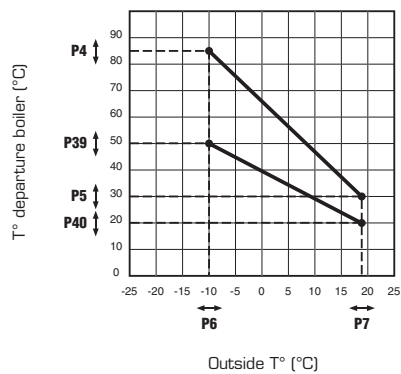

# INSTALLATION

## INSTALLATION OF TWO HEATING CIRCUITS CONTROLLED BY CONTROL UNIT AND ZMC-1 MODULE

### General diagram

This configuration controls two heating circuits (radiators or floor heating). In addition, the Room unit features a remote monitoring of the two circuits.

You can adjust those two circuits depending on the outside temperature.

This is the ideal configuration for floor heating with additional heating provided by radiators.

You can select various heating functions, and program up to three weekly schedules, as well for the central heating as for the hot water production.

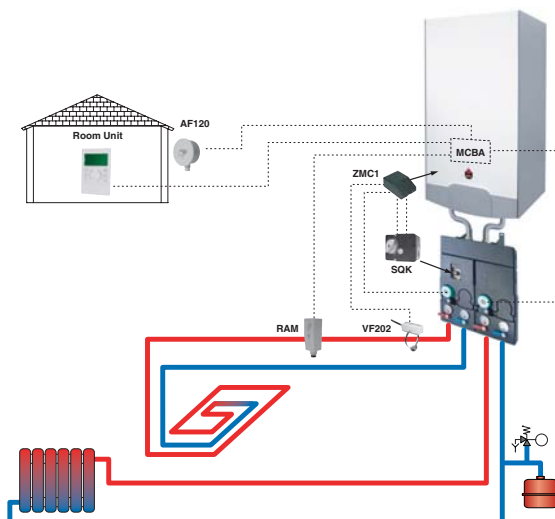

### Optional accessories

	Code	Description
	10800034	<b>Room Unit RSC :</b> Supplied with outside temperature sensor.
	10800119	<b>ZMC-1 module (kit) :</b> Controls the second heating circuit - alarm contact - operates only in conjunction with the Room Unit RSC.
	10800036	<b>Clip-in interface RMCIEBV3 :</b> Enables communications between the MCBA and the Room Unit RSC.
	10800045	<b>Contact sensor 2kΩ — VF202 :</b> To be mounted on the outlet of controlled circuit.
	10510900	<b>Contact thermostat RAM 5109 :</b> Required to protect all floor heating circuits.
	10510100	<b>Outside temperature sensor 12kΩ — AF120</b>
	10800104	<b>Collector 2 circuits DN32 :</b> With integrated wall brackets.
	10800107	<b>High temperature kit DN32:</b> Including: one circulation pump, two isolating valves, check valve, two thermometers.
	10800106	<b>Low temperature kit DN32:</b> Including: one circulation pump, two isolating valves, check valve, two thermometers, the 3-way valve with integrated bypass.
	10800142	<b>Connection kit DN32 to the manifold:</b> Including: two flexible 1"1/2 hoses and 1"1/4 reduction fittings.
	10800019	<b>Servomotor SQK 349 :</b> Electromechanical servomotor included in low temperature kit. (Opening / closing time: 150 sec.)



# INSTALLATION

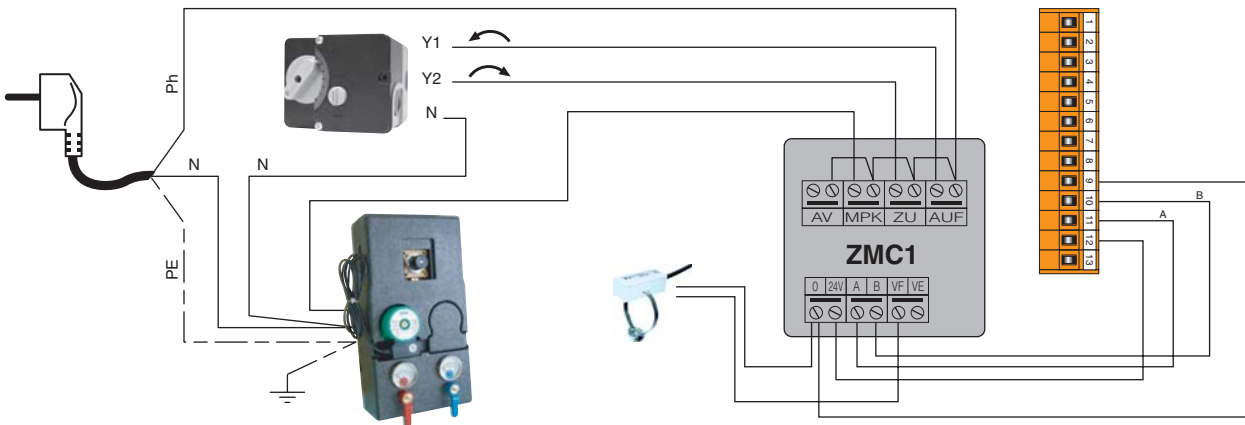
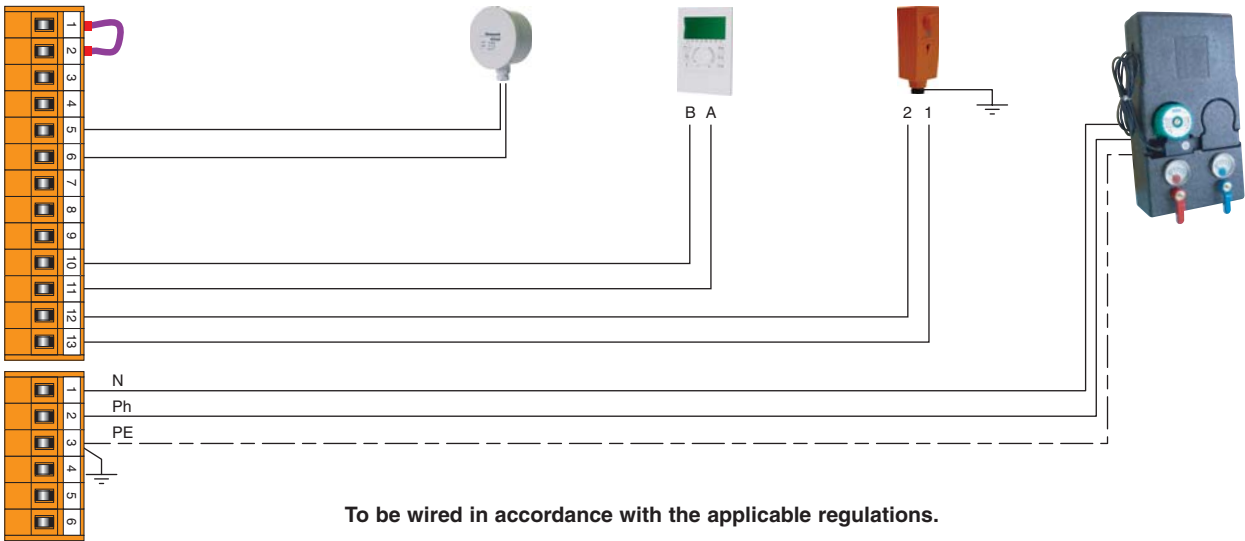

10800036: Interface address "0"

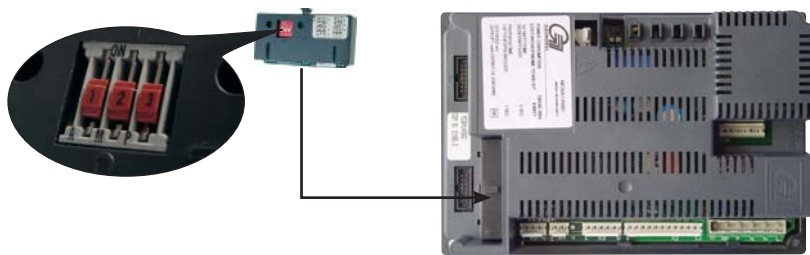
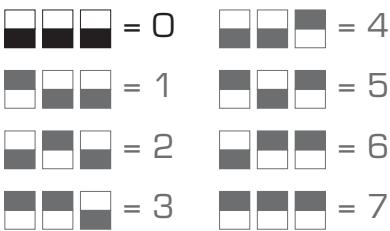

Factory setting	typical setting	Description
3.01	3.01	00 : Heating mode "OFF" 01 : Heating mode "ON"
4.85	4.85	Setting T° for the heating water (adjustable between 30 and 85°C).
P.05 1.30	P.05 1.30	T° min. for the heating water (adjustable between 15 and 60°C).



# INSTALLATION

## DOMESTIC HOT WATER CONNECTION PRESTIGE SOLO + SMART TANK

- Rinse the installation before connecting the domestic hot water circuit.
- Fill the tank before filling the heating circuit.



Before any work on the boiler, it is important to disconnect the power supply.

It is important to carry out all the electrical connection before changing the MCBA parameters.

1. The 12kΩ NTC sensor must be inserted into the dywell and connected on terminals 3 and 4. (See the picture below)..
2. Connect the DHW pump to the dedicated connector on the internal wiring (See the picture below).

### Optional accessories

Code Description



**Collector 2 circuits DN32 :**  
With integrated wall brackets.

10800107



**High temperature kit DN32:**  
Including: one circulation pump, two isolating valves, check valve, two thermometers.

10800107



**Connection kit DN32 to the manifold:**  
Including: two flexible 1"1/2 hoses and 1"1/4 reduction fittings.

10800142



**NTC sensor 12kΩ:**  
Senses the temperature in the external hot water tank.  
(Delivered with the kit 10800079)

5476G003

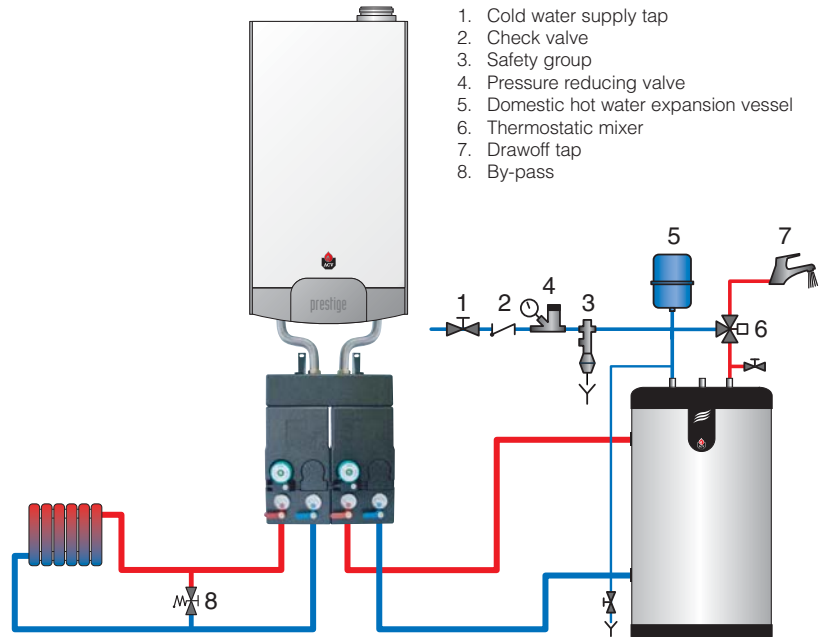
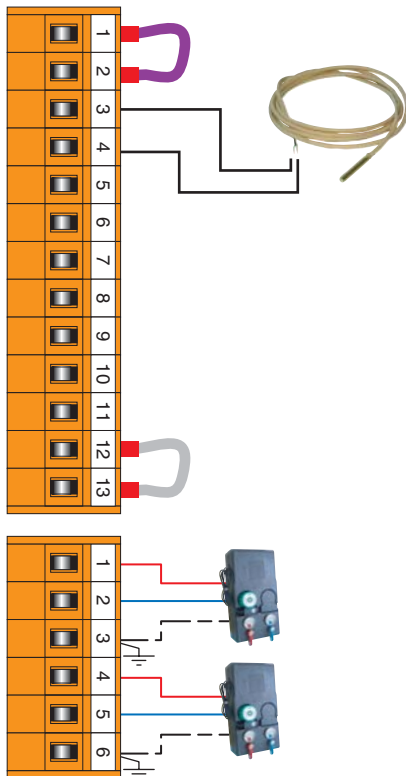

1. Cold water supply tap
2. Check valve
3. Safety group
4. Pressure reducing valve
5. Domestic hot water expansion vessel
6. Thermostatic mixer
7. Drawoff tap
8. By-pass

factory setting	typical setting	Description
1860	1867	Domestic hot water temperature setting (to be adjusted between 60 and 80°C).
2000	2001	00 : DHW Mode "OFF" 01 : DHW Mode "ON"
P035	P035	12 : Tank with NTC sensor 13 : Tank with control thermostat
0813	0812	

# COMMISSIONING AND MAINTENANCE

## COMMISSIONING THE SYSTEM



- Slowly fill the tank and drain it by opening a hot water tap. Drain all the taps and check that there are no leaks in the domestic hot water system.
- Fill the whole system up to a minimum pressure of 1 bar (preferably 1.5 bar), using the boiler's fill valve. Fill the system slowly and drain it using the central heating flow pipe manual air vent. Check that there are no leaks in the central heating system.
- Purge the circulator(s).
- Open the gas valve, drain the pipe and check that there are no leaks in the system.
- Check that the siphon is filled.
- Connect the plug to the wall socket and power on the appliance. If needed, place the room thermostat to its highest position. The boiler should start. Check the gas pressure and allow the boiler to heat up for a few minutes. Set the boiler to High Power mode and check the CO<sub>2</sub> level (see the table of Technical Characteristics). Then, set the boiler to Low Power mode and check the CO<sub>2</sub> level again (see the table of Technical Characteristics).
- Set the central heating and hot water temperatures following the values given in the Directions for Use.
- Drain the central heating system again and, if necessary, re-fill it.
- Make sure the central heating system is correctly balanced and, if necessary, adjust the valves to prevent a greater or lesser flow than planned to some circuits or radiators.

## CHECKING THE SETTINGS

- Check that the parameters are set in accordance with the user's needs: see page 3, Directions for Use.
- Check the boiler settings: this task can only be carried out by an ACV-trained installer or by the ACV maintenance department.
- Set the appliance to High Power mode by simultaneously pressing the mode and Plus keys.
- Check the dynamic gas pressure at the gas valve (see diagram below, ref. 1). This must be at least 18 mbars.

Wait a few minutes for the appliance to heat up to a minimum temperature of 60°C. Check the CO<sub>2</sub> setting using a measurement instrument. Please see in the Technical Characteristics for optimum value. To increase the CO<sub>2</sub> value, turn the venturi screw counterclockwise; turn it clockwise to reduce the value (see diagram below ref. 2).

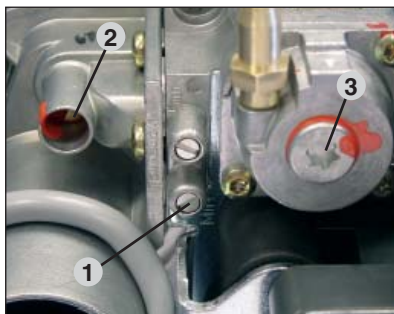

Réf. 3:  
The gas valve offset setting is a sealed factory setting. In principle, it may not be modified.

Then put the appliance to High Power mode by simultaneously pressing the mode and Plus keys. Wait a few minutes to stabilise. Check the CO<sub>2</sub> value. It should be either equal to the full power value or a maximum of 0.5% less than this value. If you record a significant deviation, please contact the ACV maintenance department.

## INSPECTION AND MAINTENANCE



**ACV recommends that you have your boilers inspected and cleaned if need be at least once a year.**

Plug out the appliance before undertaking any work, even if only recording measurements and adjusting the settings.

- Check that the siphon is not fouled, fill it, if need be, and check that there are no leaks.
- Check that the safety valves are operating correctly.
- Drain the whole system and if necessary re-fill the appliance to pressure of 1.5 bar.



**If you have to refill your circuit more than twice a year, please contact your installer.**

- Check the boiler charge in High Power mode. If there is a big difference between this value and the original setting, the deviation could mean a blockage in the air intake pipes or flue gas extraction pipes, or that the exchanger has become fouled with an accumulation of dirt.

 X 3

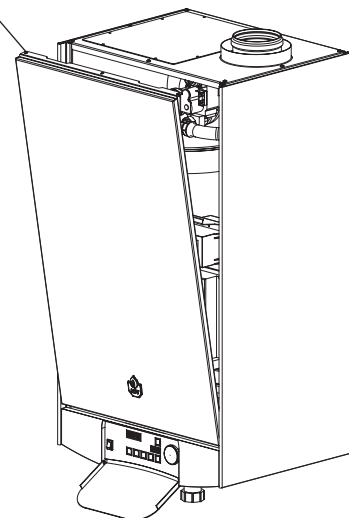

## DISASSEMBLING THE BURNER

- Close the inlet gas valve.
- Disconnect the electrical power supply.
- Remove the front panel of the boiler.
- Unplug the fan plugs (PWM & 230V), the ignition cable, the gas valve control and the ignition electrode earth.
- The upper jacket panel is removable for an easier access.
- Loosen the burner nuts using a ratchet wrench.
- Unscrew the three-way coupling on the gas pipe.
- In one unit, lift up the burner with the fan and the gas valve to remove them from the exchanger. Be careful not to damage the burner insulation in the exchanger.
- Check the condition of the insulation and the seals and replace them if necessary before re-assembling the burner following the same procedure but in the reverse order.

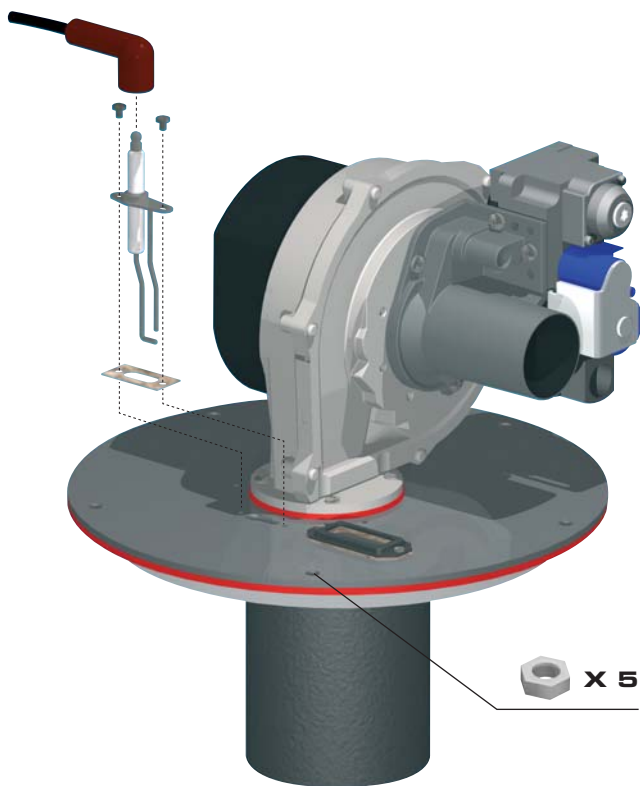

## DISASSEMBLING THE EXCHANGER

- Drain the water from the central heating system using the connection under the appliance.
- Allow the appliance to drain completely.
- Dismantle the electrical connections downstream from the burner, as well as the NTCs.
- Dismantle the exchanger central heating flow pipes and return pipes. Exercise caution when dismantling the parts as residual water may escape from the exchanger.
- Dismantle the connection at the siphon and remove the nut between the siphon and the exchanger.
- Lift up the exchanger in one piece standing upright. The exchanger detaches from its hook and is fully released.
- Check the condition of the seals and replace them if necessary before re-assembling the heat exchanger following the same procedure but in the reverse order.

## CLEANING THE HEAT EXCHANGER

- Remove the burner assembly as described above.
- Remove the burner gasket.
- Clean the combustion chamber using a vacuum cleaner.
- Disconnect the flue pipe from the exchanger.
- Check if the condensates collector is clean, if necessary, clean it.
- Check the burner insulation and the burner gasket; replace the parts if necessary.
- Check the igniter, replace if necessary
- Reassemble the burner and check for leakages.
- Power up the appliance, set the boiler in full power mode and recheck for leaks.
- Check the gas pressure and the CO<sub>2</sub> level as explained in previous paragraph.

## TEMPERATURE SENSOR RESISTANCE TABLES

T° [°C]	R Ω	T° [°C]	R Ω	T° [°C]	R Ω
- 20	98200	25	12000	70	2340
- 15	75900	30	9800	75	1940
- 10	58800	35	8050	80	1710
- 5	45900	40	6650	85	1470
0	36100	45	5520	90	1260
5	28600	50	4610	95	1100
10	22800	55	3860	100	950
15	18300	60	3250		
20	14700	65	2750		

## DISASSEMBLING AND CHECKING THE ELECTRODE

- Remove the ignition cable.
- Remove the two fixing screws.
- Remove the electrode earth but make sure the serrated washer is fixed between the earth cable and the electrode when re-assembling.
- Check the condition of the seals and replace them if necessary before re-assembling the electrode following the same procedure but in the reverse order.

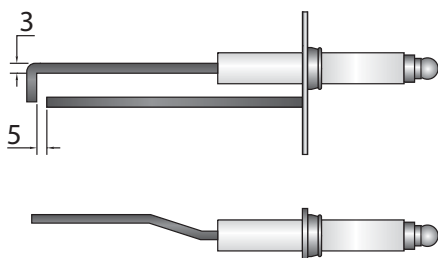

# MCBA PARAMETERS FOR THE SPECIALIST

## STANDBY MODE

### Standby Mode

5t64

After you power down the appliance the screen displays Pilot mode, as shown in the figure above.

This is the standard MCBA mode. The MCBA automatically returns to this mode after 20 minutes if no keys have been pressed on the screen. Any parameters that were modified are then enabled.

The first character shows the current status of the boiler depending on the condition of both the boiler and the burner. The last 2 characters indicate the start temperature.

Once the cause of the blockage has been resolved, the burner starts automatically within 150 seconds at most.

Status	Boiler function
0 000	Standby, no demand for heat
1 000	Fan first, fan after
2 000	Ignition
3 000	Operation of the boiler burner for the heating
4 000	Operation of the boiler burner for the domestic hot water
5 000	Air pressure limit or obtaining the number of start revolutions
6 000	The burner goes out when the specified value is reached. A demand for heat is present nonetheless.
7 000	Pump over-run time after the demand for central heating
8 000	Pump over-run time after the demand for domestic hot water
9 000	Locked burner: <ul style="list-style-type: none"> <li>• <b>6 18</b> : T1 &gt; 95°C</li> <li>• <b>6 19</b> : T2 &gt; 95°C</li> <li>• <b>6 24</b> : T2 - T1 &gt; 10°C after 90 seconds</li> <li>• <b>6 25</b> : dT1/dt &gt; maximum gradient T1</li> <li>• <b>6 26</b> : water pressure switch not off</li> <li>• <b>6 28</b> : no fan signal</li> <li>• <b>6 29</b> : erroneous fan signal</li> <li>• <b>6 30</b> : T1 - T2 &gt; max. ΔT</li> <li>• <b>6 33</b> : NTC3 short-circuit</li> <li>• <b>6 35</b> : NTC5 short-circuit</li> <li>• <b>6 38</b> : NTC3 interrupt</li> <li>• <b>6 40</b> : NTC5 interrupt</li> <li>• <b>6 52</b> : T5 &gt; T5 max</li> <li>• <b>6 65</b> : wait for the fan to start</li> </ul>

Status	Boiler function
A 000	Internal check — three-way valve
C 000	Boiler burner in hot water ready function
H 000	Test function: Central heating high power
L 000	Test function: Central heating low power
E 000	Test function: Boiler with fixed number of revolutions

If the burner is blocked for one of the reasons mentioned above, the screen display alternates between a 9 followed by the temperature (two last digits) and b with the error code.

# MCBA PARAMETERS FOR THE SPECIALIST

## SETTING THE MCBA PARAMETERS





Parameter Mode **PARA**

To access Parameter mode when the system is in Pilot mode, press **MODE** once.

To scroll through the list of parameters, simply press **STEP**. To modify a parameter value, use the + or - keys. Then press **STORE** to save the value you just changed. The screen flashes once to confirm the data has been saved.

To activate the parameters you changed, press **MODE** once more (which brings you into Info mode). However, if you do not press a key, the system returns to Pilot mode after 20 minutes and automatically enables the changes.

Key	Screen
 MODE	<b>PARA</b>

Key	Screen	Description of parameters	Factory setting	
			Prestige 50	Prestige75
 STEP	<b>1.867</b>	Adjusting the hot water temperature	<b>1.860</b>	<b>1.860</b>
 STEP	<b>2.801</b>	Production of hot water 00 = Stop 01 = Start 02 = Stop + pump continuously ON 03 = Start + pump continuously ON	<b>2.800</b>	<b>2.800</b>
 STEP	<b>3.801</b>	Turn ON/ Turn OFF the heating 00 = Stop 01 = Start 02 = Stop + pump continuously ON 03 = Start + pump continuously ON	<b>3.801</b>	<b>3.801</b>
 STEP	<b>4.870</b>	Maximum temperature in Central Heating mode	<b>4.885</b>	<b>4.885</b>



# MCBA PARAMETERS FOR THE SPECIALIST

## REQUEST FOR INFORMATION ON THE INSTALLATION











### Info Mode

INFO

To switch from **Standby** to Info mode, press **MODE** twice.

Key	Screen
	PARA
<b>MODE</b>	
	INFO
<b>MODE</b>	

Press **STEP** until the system displays the information you need. The point located behind the first position flashes to indicate that the boiler is in **INFO** mode.

Key	Screen	Description of parameters
	1.80	Start temperature T1 in °C
<b>STEP</b>		
	2.50	Return temperature T2 in °C
<b>STEP</b>		
	3.65	Hot water temperature T3 in °C
<b>STEP</b>		
	4.03	Outdoor temperature T4 in °C
<b>STEP</b>		
	5.55	Flue gas temperature
<b>STEP</b>		
	6.45	Start temperature calculated in °C
<b>STEP</b>		
	7.00	Rate of increase in the start temperature in °C/s
<b>STEP</b>		
	8.00	Rate of increase in the return temperature in °C/s
<b>STEP</b>		
	9.00	Rate of increase in the hot water temperature in °C/s
<b>STEP</b>		
	A.34	Start temperature of the 2nd central heating circuit
<b>STEP</b>		

## ENTERING THE CODE

### Code Mode

CODE

You can access the following parameters by entering the service code:

- Parameters 5 - 42
- Communication mode
- Fan Speed mode
- ERROR mode

STBY

To access Code mode, press **MODE** and **STEP** simultaneously (only from Standby mode!).

  
**MODE**

  
**STEP**

→

CODE

Press **STEP** once and the system displays **C** in position 1, followed by arbitrary characters in positions 3 and 4.

  
**STEP**

→

C 8 8

Press + or - to change the code.

  
+

or

  
-

→

C 8 8

Press **STORE**, the screen flashes briefly to indicate that the code has been accepted.

  
**STORE**

→

C 8 8

Press **MODE** until the system displays the correct mode.

 Only ACV authorised installers know the access code.

For further information, please contact our after-sales department.



# MCBA PARAMETERS FOR THE SPECIALIST

## MCBA PARAMETERS WITH CODE RESTRICTED ACCESS

Factory setting

Key	Screen	Description of parameters		Prestige 50	Prestige 75
STEP	P.05	Minimum central heating temperature when using an outdoor sensor		30	30
STEP	P.06	Minimum outdoor temperature [adjust the heating curve]		-10	-10
STEP	P.07	Maximum outdoor temperature [adjust the heating curve]		18	18
STEP	P.08	Frost protection temperature		01	01
STEP	P.09	Correction based on the outdoor temperature		00	00
STEP	P.10	Blockage T 0 = Disabled		00	00
STEP	P.11	Acceleration time lag 00 = Stop [minute]		10	10
STEP	P.12	Night set back heating (°C)		10	10
STEP	P.13	Maximum number of fan revolutions in CH mode [rpm x 100]	Natural gas	56	65
			Propane gas	56	65
STEP	P.14	Maximum number of fan revolutions in CH mode [rpm / min.]	Natural gas	00	00
			Propane gas	00	00
STEP	P.15	Max. number of revs in domestic hot water mode [rpm x 100]	Natural gas	56	65
			Propane gas	56	65
STEP	P.16	Maximum number of fan revolutions in domestic hot water mode [rpm / min.]	Natural gas	00	00
			Propane gas	00	00
STEP	P.17	Minimum number of fan revolutions [rpm x 100]	Natural gas	17	17
			Propane gas	17	17

# MCBA PARAMETERS FOR THE SPECIALIST

Factory setting

Key	Screen	Description of parameters	Prestige 50	Prestige 75	
STEP	P. 218	Minimum number of fan revolutions [rpm / min.]	Natural gas	8.800	8.800
			Propane gas	8.800	8.800
STEP	P. 219	Number of fan revolutions at ignition [rpm x 100]	Natural gas	8.840	8.840
			Propane gas	8.840	8.840
STEP	P. 220	CH pump over-run 0 = 10 sec. [step = 1 minute]	8.805	8.805	
STEP	P. 221	Domestic hot water pump over-run time [step = 10.2 sec]	8.816	8.807	
STEP	P. 222	Central Heating modulation hysteresis enabled	8.803	8.803	
STEP	P. 223	Central Heating modulation hysteresis disabled	8.803	8.803	
STEP	P. 224	Domestic hot water modulation hysteresis enabled	8.800	8.-02	
STEP	P. 225	Domestic hot water modulation hysteresis disabled	8.806	8.808	
STEP	P. 226	Detection of domestic hot water hysteresis enabled	8.810	8.810	
STEP	P. 227	Detection of domestic hot water hysteresis disabled	8.800	8.800	
STEP	P. 228	Central Heating blockage time [sec. x 10,2]	8.805	8.805	
STEP	P. 229	Domestic hot water blockage time [sec. x 10,2]	8.800	8.800	
STEP	P. 230	Domestic hot water → Central Heating blockage time [sec. x 10,2]	8.820	8.806	

# MCBA PARAMETERS FOR THE SPECIALIST



Factory setting





Key	Screen	Description of parameters	Factory setting	
			Prestige 50	Prestige 75
STEP	P.31	Re-modulate the difference T1 - T2	P.24	30
STEP	P.32	Shell address [-1 = disabled]	-01	-01
STEP	P.33	Temperature increase set point for the production of hot water	13	10
STEP	P.34	first position: 2nd heating circuit: 0 = disabled 1 = enabled [slave] 2 = enabled [master]  Second position: the demand for heat comes from: 0 = the room thermostat 1 = the outdoor sensor	00	00
STEP	P.35	First position: Domestic hot water pump [1] or three-way mixer tap [2]  Second position: tank with NTC3 probe [2] or tank with thermostat (3)	13	10
STEP	P.36	Manual fan number of revolutions	-01	-01
STEP	P.37	First position: Fan control pump level during burning in  Second position: Fan control pump level +during over-run time	11	11
STEP	P.38	Hold temperature	00	00
STEP	P.39	Maximum temperature for the start heating curve for the 2nd circuit	50	50
STEP	P.40	Minimum temperature for the start heating curve for the 2nd circuit	20	20
STEP	P.41	2nd circuit temperature hysteresis	06	06
STEP	P.42	First position: Special pump [0 = disabled]  Second position: Minimum disable cycle [0 = disabled]	00	00

# MCBA PARAMETERS FOR THE SPECIALIST





## COMMUNICATION MODE [with code]

When in this mode, the system displays the communication between the boiler and the control module, the optional interface kit or the optional programmable room thermostat.

Key	Screen
	
MODE	



Key	Screen	Description of parameters
		No communication
		Communication between the boiler module and the optional control modules only
		Communication between all the devices connected













## FAN MODE [with code]

Key	Screen	Description of parameters
		Fan speed
		The current fan speed is 5,500 rpm.

## ERREUR MODE [with code]

**ERROR** mode indicates the most recent error, as well as the status of the boiler and its readings at the time this error occurred.

Key	Screen
	
MODE	

Key	Screen	Description of parameters
		Code error mode
		Status of the boiler at the time of the error
		Start temperature T1 at the time of the error
		Return temperature T2 at the time of the error
		Hot water temperature T3 at the time of the error
		Outdoor temperature T4 at the time of the error

# MCBA PARAMETERS FOR THE SPECIALIST

## SAFETY STOP+ RESOLUTION OF THE FAULT [ERROR mode]

If a fault occurs while the appliance is running, the system locks and the screen starts to flash.

The first character is an **E** and the next two characters give the code for this fault, as illustrated in the table below.



To unlock the system:



- Press **RESET** on the screen.
- Contact your installer if the fault happens again.

Codes	Description of the fault	Resolution of the fault
	Abnormal flame signal	<ul style="list-style-type: none"> <li>- Check the wiring (short-circuit in the 24V wiring)</li> <li>- Check the electrode</li> <li>- Replace the MCBA (water damage)</li> </ul>
	No flame signal after five attempts at firing the boiler	<ul style="list-style-type: none"> <li>- Check the ignition cable</li> <li>- Check the electrode and the position of the electrode</li> <li>- Check that there is gas at the burner.</li> </ul>
	Internal error	If the problem persists after two <b>RESET</b> attempts, replace the MCBA.
	Persistent lock	Press <b>RESET</b>
 ↓ 	Internal error	If the problem persists after two <b>RESET</b> attempts, replace the MCBA.
	EPROM error	If the problem persists after two <b>RESET</b> attempts, replace the MCBA.
	Max input, thermostat open or 24V fuse gone.	<ul style="list-style-type: none"> <li>- Check the wiring</li> <li>- Check the 24V fuse on the MCBA.</li> <li>- Missing shunt 12-13</li> </ul>
 ↓ 	Internal error	If the problem persists after two <b>RESET</b> attempts, replace the MCBA.
	T1 > 110°C	<ul style="list-style-type: none"> <li>- Check the NTC wiring and replace if necessary.</li> <li>- If NTC1 is OK, please verify that the water flows through the boiler.</li> </ul>
	T2 > 110°C	<ul style="list-style-type: none"> <li>- Check the NTC wiring and replace if necessary.</li> </ul>
	T1 gradient too high	<ul style="list-style-type: none"> <li>- Check that the pump is turning.</li> <li>- If there is no problem with the pump, drain the system.</li> </ul>
	No fan signal present	<ul style="list-style-type: none"> <li>- Check the fan control connection</li> <li>- Check the fan wiring</li> </ul> <p>If the problem persists after two <b>RESET</b> attempts, replace the MCBA.</p>
	The tachometer signal of the blower does not go to zero.	<ul style="list-style-type: none"> <li>- Check that the convection flow through the chimney is not high enough to rotate the blower.</li> </ul> <p>If not, exchange the blower.</p>
	NTC1 short-circuit	<ul style="list-style-type: none"> <li>- Check the connection of the NTC1 sensor</li> <li>- Check the wiring of the NTC1 sensor</li> </ul> <p>If the problem persists, replace the NTC1 sensor</p>
	NTC2 short-circuit	<ul style="list-style-type: none"> <li>- Check the connection of the NTC2 sensor</li> <li>- Check the wiring of the NTC2 sensor</li> </ul> <p>If the problem persists, replace the NTC2 sensor</p>

## MCBA PARAMETERS FOR THE SPECIALIST

Codes	Description of the fault	Resolution of the fault
<b>E833</b>	NTC3 short-circuit	<ul style="list-style-type: none"> <li>- Check the connection of the NTC3 sensor</li> <li>- Check the wiring of the NTC3 sensor</li> </ul> <p>If the problem persists, replace the NTC3 sensor</p>
<b>E836</b>	NTC1 connection open	<ul style="list-style-type: none"> <li>- Check the connection of the NTC1 sensor</li> <li>- Check the wiring of the NTC1 sensor</li> </ul> <p>If the problem persists, replace the NTC1 sensor</p>
<b>E837</b>	NTC2 connection open	<ul style="list-style-type: none"> <li>- Check the connection of the NTC2 sensor</li> <li>- Check the wiring of the NTC2 sensor</li> </ul> <p>If the problem persists, replace the NTC2 sensor</p>
<b>E838</b>	NTC3 connection open	<ul style="list-style-type: none"> <li>- Check the connection of the NTC3 sensor</li> <li>- Check the wiring of the NTC3 sensor</li> </ul> <p>If the problem persists, replace the NTC3 sensor</p>
<b>E844</b>	Internal error	<p>If the problem persists after two <b>RESET</b> attempts, replace the MCBA.</p>
<b>E852</b>	Flue gas temperature too high (NTC5)	<ul style="list-style-type: none"> <li>- Check the connection of the NTC5 sensor</li> <li>- Check the wiring of the NTC5 sensor</li> </ul> <p>If the problem persists, replace the NTC5 sensor</p>
<b>E860</b>	Error while reading the parameters	<p>Press <b>RESET</b></p> <p>If the error persists, replace the MCBA.</p>
<b>E865</b>	Problem with the power supply to the fan	<ul style="list-style-type: none"> <li>- Check the MCBA power supply voltage.</li> </ul> <p>If it is OK, replace the fan.</p>



<p><b>537D6197</b></p> 	<p><b>EN :</b> Vertical outlet</p> <p><b>FR :</b> Terminal vertical</p> <p><b>NL :</b> Dakdoorvoer</p> <p><b>ES :</b> Terminal vertical</p> <p><b>IT :</b> Terminale verticale</p> <p><b>DE :</b> Senkrechte Dachdurchführung</p>	<p><b>537D6205</b></p> 	<p><b>EN :</b> Condensate recovery</p> <p><b>FR :</b> Récupérateur de condensats</p> <p><b>NL :</b> Condensopvang</p> <p><b>ES :</b> Recuperador de condensados</p> <p><b>IT :</b> Recuperatore di condensati</p> <p><b>DE :</b> Kondensatsammler</p>
<p><b>537D6198</b></p> 	<p><b>EN :</b> Horizontal outlet</p> <p><b>FR :</b> Terminal horizontal</p> <p><b>NL :</b> Muurdoorvoer</p> <p><b>ES :</b> Terminal horizontal</p> <p><b>IT :</b> Tereminale orizzontale</p> <p><b>DE :</b> Waagerechte Wanddurchführung</p>	<p><b>537D6206</b></p> 	<p><b>EN :</b> Measuring element</p> <p><b>FR :</b> Tube de mesure</p> <p><b>NL :</b> Meetelement</p> <p><b>ES :</b> Tubo de medida</p> <p><b>IT :</b> Elemento di misura</p> <p><b>DE :</b> Messelement</p>
<p>(L 250 mm) <b>537D6199</b> (L 500 mm) <b>537D6200</b> (L 1000 mm) <b>537D6201</b></p> 	<p><b>EN :</b> Flue pipe</p> <p><b>FR :</b> Conduite</p> <p><b>NL :</b> Rookgaspijp</p> <p><b>ES :</b> Tubo</p> <p><b>IT :</b> Prolunga</p> <p><b>DE :</b> Rohr</p>	<p><b>537D6207</b></p> 	<p><b>EN :</b> Parallel connection adapter</p> <p><b>FR :</b> Adaptateur de raccordement en parallèle</p> <p><b>NL :</b> Parallel aansluitingsadapter</p> <p><b>ES :</b> Adaptador de conexión paralelo</p> <p><b>IT :</b> Adattatore di collegamento in parallelo</p> <p><b>DE :</b> Paralleler Verbindungsadapter</p>
<p><b>537D6202</b></p> 	<p><b>EN :</b> Adjustable pipe (L 325 - 400 mm)</p> <p><b>FR :</b> Conduite réglable (L 325 - 400 mm)</p> <p><b>NL :</b> Regelbare rookgaspijp instelbaar (L 325 - 400 mm)</p> <p><b>ES :</b> Tubo regulable (L 325 - 400 mm)</p> <p><b>IT :</b> Prolunga regolabile (L 325 - 400 mm)</p> <p><b>DE :</b> Verstellbares Rohr einstellbar (L 325 - 400 mm)</p>	<p><b>537D6208</b></p> 	<p><b>EN :</b> Flat roof flashing</p> <p><b>FR :</b> Solin toit plat</p> <p><b>NL :</b> Losse pan plat dak</p> <p><b>ES :</b> Placa con cojinete desmontable para techo</p> <p><b>IT :</b> Tegola a tetto piatta</p> <p><b>DE :</b> Flachdachflansch</p>
<p><b>537D6203</b></p> 	<p><b>EN :</b> Flue bend 45°</p> <p><b>FR :</b> Coude 45°</p> <p><b>NL :</b> Bocht 45°</p> <p><b>ES :</b> Codo 45°</p> <p><b>IT :</b> Curva 45°</p> <p><b>DE :</b> Bogen 45°</p>	<p><b>537D6209</b></p> 	<p><b>EN :</b> Adjustable flashing</p> <p><b>FR :</b> Solin réglable</p> <p><b>NL :</b> Regelbare losse pan</p> <p><b>ES :</b> Cojinete desmontable regulable</p> <p><b>IT :</b> Tegola regolabile</p> <p><b>DE :</b> Bleidachpfanne</p>
<p><b>537D6204</b></p> 	<p><b>EN :</b> Flue bend 90°</p> <p><b>FR :</b> Coude 90°</p> <p><b>NL :</b> Bocht 90°</p> <p><b>ES :</b> Codo 90°</p> <p><b>IT :</b> Curva 90°</p> <p><b>DE :</b> Bogen 90°</p>	<p><b>537D6210</b></p> 	<p><b>EN :</b> Bracket Ø 125 mm</p> <p><b>FR :</b> Attache de fixation Ø 125 mm</p> <p><b>NL :</b> Bevestiging Ø 125 mm</p> <p><b>ES :</b> Fijación Ø 125 mm</p> <p><b>IT :</b> Supporto di fissazione Ø 125 mm</p> <p><b>DE :</b> Befestigung Ø 125 mm</p>



N°	EN	FR	NL	ES	IT	DE
A01	Side panel	Latérale	Zijkanten	Lateral	Laterale	Seitenblech
A02	Front panel	Face avant	Frontstuk	Parte delantero	Pannello anteriore	Vorderblech
A03	Top cover	Couvercle supérieur	Bovenkap	Tapa superior	Coperchio superiore	Obere Abdeckung
A04	Rear panel	Panneau arrière	Achterpaneel	Panel trasero	Pannello posteriore	Hinterblech
A05	Control panel [ABS]	Tableau [ABS]	Paneel [ABS]	Panel [ABS]	Pannello [ABS]	ABS-Tafel
A06	Wall mounting	Fixation murale	Wandbevestiging	Fijación mural	Fissaggio murale	Wandhalterung
A07	Opening top cover	Ouverture couvercle supérieur	Afneembaarpaneel bovenplaat	Apertura tapa superior	Apertura coperchio superiore	Aufnehmbares Oberdeckel
A08	Back cover plate display	Protection arrière du display	Afschermplaat display achter	Protección posterior del display	Protezione posteriore del display	Abschirmung hinter display
A09	Bottom panel	Jaquette inferieure	Onderpaneel	Panel inferior	Pannello inferiore	Unterblech

N°	EN	FR	NL	ES	IT	DE
B01	Flue gas pipe Ø 100 mm	Tube de fumées Ø 100 mm	Rookgas pijp Ø 100 mm	Tubo de humos Ø 100 mm	Condotto fumi Ø 100 mm	Abgasrohr Ø 100 mm
B02	Heat exchanger	Echangeur de chaleur	Warmtewisselaar	Intercambiador de calor	Scambiatore di calore	Wärmetauscher
B03	Exchanger flow pipe	Tube de départ de l'échangeur	Aanvoerleiding warmtewisselaar	Tubo de salida del intercambiador de calor	Tubo di mandata da lo scambiatore	Vorlaufrohr Wärmetauscher
B04	Condenstrap 5/4" - L 300 mm	Siphon 5/4" L 300 mm	Syfon 5/4" L 300 mm	Sifón 5/4" L 300 mm	Sifone 5/4" L 300 mm	Siphon 5/4" L 300 mm
B05	Gas pipe	Tube gaz	Gas pijp	Tubo gas	Tubo gas	Gasrohr
B06	Heating return pipe	Tube retour chauffage	Terugvoer verwarming pijp	Tubo retorno de calefacción	Tubo di ritorno riscaldamento	Heizungsruchlaufrohr





### Prestige Solo 50 - 75

A07 : 507F5016

A03 : 21475423

A01 : 507F5001

A06 : 21480069

A02 : 507F5013

A04 : 507F5002

A05 : 54761008

A01 : 507F5001

A08 : 2147E419

A09 : 507F5015

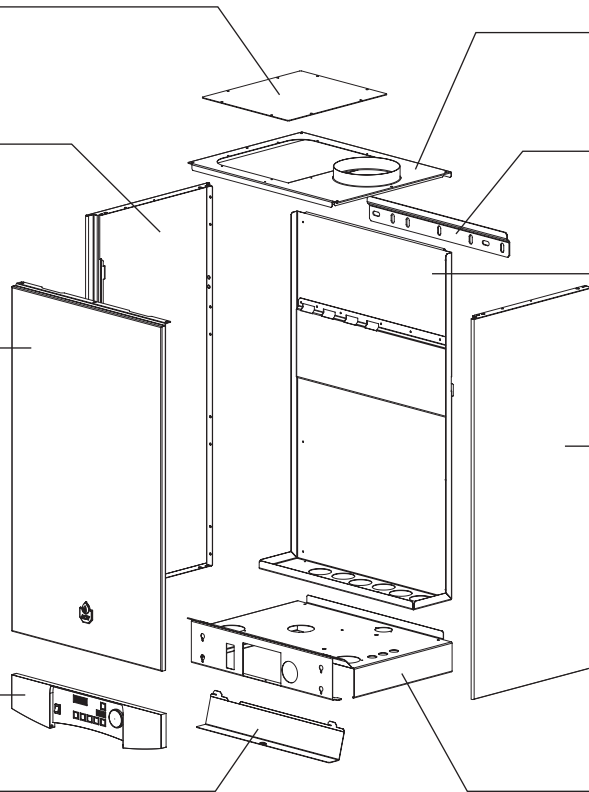

### Prestige Solo 50 - 75

B01 : 497B0035

B05 : 507F4106

B02 : 63962010

B03 : 507F4104

B06 : 507F4105

B04 : 557A8000

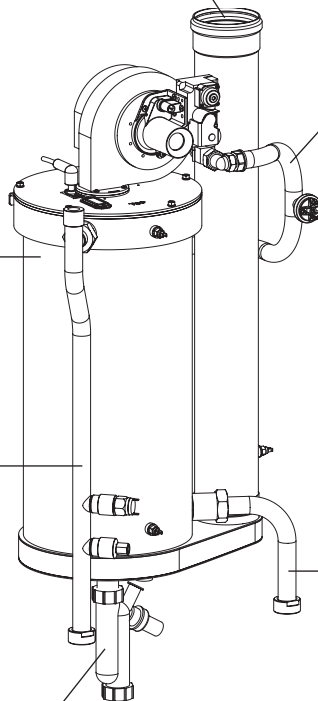



N°	EN	FR	NL	ES	IT	DE
<b>C01</b>	Fan Prestige 50	Ventilateur Prestige 50	Ventilator Prestige 50	Ventilador Prestige 50	Ventilatore Prestige 50	Gebläse Prestige 50
<b>C02</b>	Fan Prestige 75	Ventilateur Prestige 75	Ventilator Prestige 75	Ventilador Prestige 75	Ventilatore Prestige 75	Gebläse Prestige 75
<b>C03</b>	Ignition electrode	Electrode d'allumage	Ontstekings electrode	Electrodo de encendido	Elettrodo di accensione	Zündelectrode
<b>C04</b>	Electrode seal	Joint électrode	Dichting electrode	Junta de electrodo	Guarnizione elettrodo	Dichtung Elektrode
<b>C05</b>	Burner flange	Plaque brûleur	Branderflens	Placa quemador	Piastra bruciatore	Brennerflansch
<b>C06</b>	Burner rod	Rampe brûleur	Branderstaaf	Rampa quemador	Rampa bruciatore	Brennerlanze
<b>C07</b>	Burner seal Ø 210 mm	Joint brûleur Ø 210 mm	Branderdichting Ø 210 mm	Junta de quemador Ø 210 mm	Guarnizione bruciatore Ø 210	Brennerdichtung Ø 210 mm
<b>C08</b>	Burner flange insulation	Isolation plaque brûleur	Dichting branderflens	Aislamiento placa quemador	Isolamento piastra bruciatore	Isolierung Brennerflansch
<b>C09</b>	Burner rod seal	Joint rampe brûleur	Dichting branderstaaf	Junta de rampa quemador	Guarnizione rampa bruciatore	Dichtung Brennerlanze
<b>C10</b>	Flame inspection window	Regard de flamme	Vlamcontrole	Tapa de llama	Spioncino fiamma	Schauloch Flamme
<b>C11</b>	Silicone seal fan	Joint silicone ventilateur	Siliconedichting ventilator	Junta de silicona ventilador	Guarnizione silicone del ventilatore	Silikondichtung Gebläse
<b>C12</b>	Venturi O-ring	O-ring venturi	O-ring venturi	Anillo venturi	Anello venturi	O-Ring venturi
<b>C13</b>	Gas valve flange Ø 1/2"	Bride vanne gaz Ø 1/2"	Gasklepflens Ø 1/2"	Brida de válvula de gas Ø 1/2"	Piastra valvola gas Ø 1/2"	Flansh Gasventil Ø 1/2"
<b>C14</b>	Gas valve	Vanne gaz	Gasklep	Válvula de gas	Valvola gas	Gasventil
<b>C15</b>	Orifice Ø 60 mm Prestige 50	Opercule Ø 60 mm Prestige 50	Diafragma Ø 60 mm Prestige 50	Diafragma Ø 60 mm Prestige 50	Diaframma Ø 60 mm Prestige 50	Diafragma Ø 60 mm Prestige 50
<b>C16</b>	Orifice Ø 68 mm Prestige 75	Opercule Ø 68 mm Prestige 75	Diafragma Ø 68 mm Prestige 75	Diafragma Ø 68 mm Prestige 75	Diaframma Ø 68 mm Prestige 75	Diafragma Ø 68 mm Prestige 75
<b>C17</b>	Venturi [001] Prestige 50	Venturi [001] Prestige 50	Venturi [001] Prestige 50	Venturi [001] Prestige 50	Venturi [001] Prestige 50	Venturi [001] Prestige 50
<b>C18</b>	Venturi [051] Prestige 75	Venturi [051] Prestige 75	Venturi [051] Prestige 75	Venturi [051] Prestige 75	Venturi [051] Prestige 75	Venturi [051] Prestige 75
<b>C19</b>	Venturi seal	Joint venturi	Dichting venturi	Junta venturi	Guarnizione venturi	Dichtung venturi



## Prestige Solo 50 - 75

C01 : 537D3027  
C02 : 537D3033

C17 : 537D6038  
C18 : 537D4028

C19 : 557A0026

C15 : (\*) 537D4013  
C16 : (\*) 537D4037

C03 : 537DZ023

C14 : 537D4033

C04 : 557A0012

C11 : 557A0054

C13 : 53402086

C12 : 557D6039

C10 : 507F4096

C05 : 507F4103

C09 : 507A0065

C06 : 537DZ027

C08 : 51700062









C07 : 557A0066

(\*)  
Burner propane - Brûleur propane - Brander propaan  
Quemador propano - Bruciatore propano - Propangasbrenner



<p><b>55439129</b></p> 	<p><b>EN :</b> Water pressure safety switch</p> <p><b>FR :</b> Pressostat de sécurité manque d'eau</p> <p><b>NL :</b> Waterdruk schakelaar</p> <p><b>ES :</b> Presostato falta de agua</p> <p><b>IT :</b> Pressostato di sicurezza mancanza d'acqua</p> <p><b>DE :</b> Wassermangelsicherung</p>	<p><b>547D3021</b></p> 	<p><b>EN :</b> Transformer [230 Volt / 24 Volt]</p> <p><b>FR :</b> Transformateur [230 Volt / 24 Volt]</p> <p><b>NL :</b> Transformator [230 Volt / 24 Volt]</p> <p><b>ES :</b> Transformador [230 Volt / 24 Volt]</p> <p><b>IT :</b> Trasformatore [230 Volt / 24 Volt]</p> <p><b>DE :</b> Transformator [230 Volt / 24 Volt]</p>
<p><b>537DC000</b></p> 	<p><b>EN :</b> Gas pressure switch</p> <p><b>FR :</b> Pressostat gaz</p> <p><b>NL :</b> Gasdrukschakelaar</p> <p><b>ES :</b> Presostato de gas</p> <p><b>IT :</b> Pressostato gas</p> <p><b>DE :</b> Gasdruckwächter</p>	<p><b>537D3020</b></p> 	<p><b>EN :</b> Display board</p> <p><b>FR :</b> Platine display</p> <p><b>NL :</b> Display</p> <p><b>ES :</b> Display</p> <p><b>IT :</b> Scheda display</p> <p><b>DE :</b> Display</p>
<p><b>55445006</b></p> 	<p><b>EN :</b> Manual air vent [Ø 1/2"]</p> <p><b>FR :</b> Purgeur manuel [Ø 1/2"]</p> <p><b>NL :</b> Manuele ontluchter [Ø 1/2"]</p> <p><b>ES :</b> Purgador manual [Ø 1/2"]</p> <p><b>IT :</b> Sfiato manuale [Ø 1/2"]</p> <p><b>DE :</b> Manueller Entlüfter [Ø 1/2"]</p>	<p><b>54763010</b></p> 	<p><b>EN :</b> Pressure gauge [0 - 4 bars]</p> <p><b>FR :</b> Manomètre [0 - 4 bars]</p> <p><b>NL :</b> Manometer [0 - 4 bar]</p> <p><b>ES :</b> Manómetro [0 - 4 bares]</p> <p><b>IT :</b> Manometro [0 - 4 bar]</p> <p><b>DE :</b> Manometer [0 - 4 bar]</p>
<p><b>547G008</b></p> 	<p><b>EN :</b> NTC sensor [5 x 18 = 12 kΩ]</p> <p><b>FR :</b> Sonde NTC [5 x 18 = 12 kΩ]</p> <p><b>NL :</b> NTC voeler [5 x 18 = 12 kΩ]</p> <p><b>ES :</b> Sonda NTC [5 x 18 = 12 kΩ]</p> <p><b>IT :</b> Sonda NTC [5 x 18 = 12 kΩ]</p> <p><b>DE :</b> NTC-Fühler [5 x 18 = 12 kΩ]</p>	<p><b>54766016</b></p> 	<p><b>EN :</b> ON / OFF switch</p> <p><b>FR :</b> Interrupteur général</p> <p><b>NL :</b> Hoofdschakelaar</p> <p><b>ES :</b> Interruptor general</p> <p><b>IT :</b> Interruttore generale</p> <p><b>DE :</b> An / Aus Schalter</p>
<p><b>537D5015</b></p> 	<p><b>EN :</b> Ignition and ionisation cable</p> <p><b>FR :</b> Câble d'allumage et d'ionisation</p> <p><b>NL :</b> Ontsteek / ionisatie kabel</p> <p><b>ES :</b> Cable de encendido y ionización</p> <p><b>IT :</b> Cavo di accensione e d'ionizzazione</p> <p><b>DE :</b> Ionisations- und Zündungskabel</p>	<p><b>497B0025</b></p> 	<p><b>EN :</b> Air inlet tube to venturi</p> <p><b>FR :</b> Tube d'entrée d'air venturi</p> <p><b>NL :</b> Inlaatbuis venturi</p> <p><b>ES :</b> Tubo de entrada de aire venturi</p> <p><b>IT :</b> Tubo d'ingresso dell'aria nel venturi</p> <p><b>DE :</b> Eintrittrohr Venturi</p>
<p><b>537D3016</b></p> 	<p><b>EN :</b> Rectifier [24 Volt]</p> <p><b>FR :</b> Câble rectificateur [24 Volt]</p> <p><b>NL :</b> Gelijkrichter [24 Volt]</p> <p><b>ES :</b> Cable rectificador [24 Volt]</p> <p><b>IT :</b> Cavo rettificatore [24 volt]</p> <p><b>DE :</b> Gleichrichter [24 Volt]</p>	<p><b>257F1079</b></p> 	<p><b>EN :</b> Flat cable</p> <p><b>FR :</b> Câble plat</p> <p><b>NL :</b> Kabel display</p> <p><b>ES :</b> Cable plano</p> <p><b>IT :</b> Cavo piatto</p> <p><b>DE :</b> Kabel display</p>



<b>Prestige 50</b> <b>5476G029</b> 	<b>EN :</b> MCBA burner control [Natural gas]	<b>557A0064</b> 	<b>EN :</b> Silicon gasket Ø 100 mm
	<b>FR :</b> Module de contrôle MCBA [Gaz naturel]		<b>FR :</b> Joint en silicone Ø 100 mm
	<b>NL :</b> Brander module MCBA [Aardgas]		<b>NL :</b> Afdichtring Ø 100 mm
	<b>ES :</b> Módulo de control MCBA [Gas natural]		<b>ES :</b> Junta de silicona Ø 100 mm
	<b>IT :</b> Centralina MCBA [Gas naturale]		<b>IT :</b> Giunto in silicone Ø 100 mm
	<b>DE :</b> MCBA- Brennersteuerung [Erdgas]		<b>DE :</b> Abdichtung Ø 100 mm
<b>Prestige 50</b> <b>5476G030</b> 	<b>EN :</b> MCBA burner control [Propane]	<b>43416134</b> 	<b>EN :</b> Union MF gas Ø 1/2"
	<b>FR :</b> Module de contrôle MCBA [Propane]		<b>FR :</b> Raccord union gaz Ø 1/2"
	<b>NL :</b> Brander module MCBA [Propaan]		<b>NL :</b> Driedelige gaskoppeling Ø 1/2"
	<b>ES :</b> Módulo de control MCBA [Propano]		<b>ES :</b> Ø 1/2"
	<b>IT :</b> Centralina MCBA [Propano]		<b>IT :</b> Ø 1/2"
	<b>DE :</b> MCBA- Brennersteuerung [propangas]		<b>DE :</b> Kupplung MF gas Ø 1/2"
<b>Prestige 75</b> <b>5476G031</b> 	<b>EN :</b> MCBA burner control [Natural gas]	<b>43720000</b> 	<b>EN :</b> Reduction [Ø 3/4" - 1/2"]
	<b>FR :</b> Module de contrôle MCBA [Gaz naturel]		<b>FR :</b> Réduction gaz [Ø 3/4" - 1/2"]
	<b>NL :</b> Brander module MCBA [Aardgas]		<b>NL :</b> Overgangstuk [Ø 3/4" - 1/2"]
	<b>ES :</b> Módulo de control MCBA [Gas natural]		<b>ES :</b> Reducción gas [Ø 3/4" - 1/2"]
	<b>IT :</b> Centralina MCBA [Gas naturale]		<b>IT :</b> Riduzione gas [Ø 3/4" - 1/2"]
	<b>DE :</b> MCBA- Brennersteuerung [Erdgas]		<b>DE :</b> Redusierung [Ø 3/4" - 1/2"]
<b>Prestige 75</b> <b>5476G032</b> 	<b>EN :</b> MCBA burner control [Propane]	<b>24614138 (*)</b> 	<b>EN :</b> Complete control board
	<b>FR :</b> Module de contrôle MCBA [Propane]		<b>FR :</b> Câblage complet
	<b>NL :</b> Brander module MCBA [Propaan]		<b>NL :</b> Kompleet controlepaneel
	<b>ES :</b> Módulo de control MCBA [Propano]		<b>ES :</b> Cableado completo
	<b>IT :</b> Centralina MCBA [Propano]		<b>IT :</b> Cablaggio completo
	<b>DE :</b> MCBA- Brennersteuerung [propangas]		<b>DE :</b> Komplettes Bedienfeld

(\*) MCBA not programmed / MCBA non programmé / MCBA niet- voor- geprogrammeerd / MCBA no programado / MCBA non programmato / MCBA nicht vorprogrammiert.



A series of horizontal dotted lines for writing, spanning the width of the page.