

HM

HeatMaster®

Installation, Operating and Servicing Instructions

HeatMaster® 201



excellence in hot water



INTRODUCTION	1
Target group	1
Symbols	1
Certification	1
General information and safety instructions	2
USER GUIDE	2
Using the boiler	2
Setting the parameters	3
DESCRIPTION	4
Operating principle	4
Packing	4
Construction features	4
TECHNICAL SPECIFICATION	6
Effective dimensions	6
General characteristics	6
Maximum operating conditions	7
Domestic hot water performances	7
HeatMaster® setting instructions	7
INSTALLATION	8
Boiler room	8
Chimney connections	8
Hot water connections	9
Heating connection	10
Electrical connections	10
COMMISSIONING	12
Filling the hot water and heating circuits	12
BURNER FEATURES	12
ACV BG 2000-M modulating premix gas burner	12
MAINTENANCE	14
Service intervals	14
Servicing the boiler	14
Servicing the safety devices	14
Servicing the burner	14
Draining the boiler	14
MCBA FOR SPECIALISTS: INSTALLER, SERVICE ENGINEER	15
Pilot mode	15
Safety stop (Error mode)	16
Setting the parameters	17
Entering the code	20
Information on the installation	20
Communication mode (with code)	21
Error mode	21
SPARE PARTS	22
Jackets	22
Accessories	22
Setting and electrical accessories	22
Burner	22
SERVICE RECORD	23
Installation details	23
Service notes	23

TARGET GROUP

This manual is intended for the use of:

- final users of the appliance;
- the engineer installing and starting up the appliance;
- the engineering and design department;
- the installer responsible for servicing or maintaining the appliance.

SYMBOLS

The following symbols are used in these instructions:



Essential instruction for operating the system correctly.



Essential instruction for personal safety or environmental protection.



Danger of electrocution.



Risk of scalding.

CERTIFICATION

The appliances carry the “CE” mark, in accordance with the standards in force in the various countries (European Directives 92/42/CEE “Efficiency” and 90/396/CEE “Gas Appliances”). They also carry the labels, “HR+”.



INTRODUCTION

GENERAL INFORMATION AND SAFETY INSTRUCTIONS

IF YOU SMELL GAS:

- Immediately shut off the gas supply.
- Ventilate the boiler room.
- Do not use electrical appliances and do not switch anything on or off.
- Immediately notify your gas company and/or your installer.

General information

This documentation forms part of the items delivered with the appliance and must be given to the user to keep in a safe place!

This appliance must be serviced and repaired by an approved installer, in accordance with current standards in force.

ACV declines all liability for any damage caused as a result of incorrect installation or as a result of the use of components or connections that are not approved by ACV for this application.

Temperatures



This boiler is designed for central heating systems with a maximum outlet temperature of 90°C. Therefore, the central heating pipelines and the radiators must reach this temperature.

The waste-gas pipe lines must reach temperatures in excess of 100°C.

The hot water can reach temperatures in excess of 60°C.

Installation



Before installing and commissioning the boiler, first carefully read this manual.

Position the **HeatMaster**® according to the safety rules and standards in force. You must comply with the ventilation requirements for the room where appliances of this type are installed. All air vents must remain unobstructed at all times.

It is prohibited to modify the interior of the appliance in any way, without the manufacturer's prior written agreement.

Service

In order to ensure the appliance operates safely and correctly, it is important to have it serviced and reconditioned every year by an installer or an approved service company.

Faults

Despite the strict quality standards imposed on its appliances by ACV during production, inspection, and transport, faults may occur. Please immediately inform your approved installer about such faults. Remember to give the fault code as it appears on the screen. (See also the list of faults on page 16)

Only genuine factory parts may be used as replacement parts. Please go to page 22 for a list of spare parts and their ACV reference numbers.

Note: ACV reserves the right to change the technical characteristics and specification of its products without notices.

USING THE BOILER

Starting the burner

During operation, the burner starts automatically as soon as the temperature of the boiler is below the set point and goes off when this value is reached.

Control panel

Summer/Winter switch

Main switch

Display – MCBA controller

Thermostat-pressure gauge



The user must not attempt to gain access to the components inside the control panel.

Heating system pressure

From time to time you may need to top up the heating system pressure. This pressure is indicated by the combined temperature and pressure gauge on the boiler control panel.

The minimum pressure when the boiler is cold should be 1 bar. The precise operating pressure required depends on the height of the building, and your installer will have informed you of this value at the time of installation (see Commissioning Section - Filling the hot water and heating circuits).

If the pressure falls below 1 bar, the boiler water pressure switch will turn the boiler off until pressure is restored.

To re-pressurise, the system needs to be topped up with water. First, switch the boiler OFF on the on/off switch and isolate the external electrical supply. The fill valves A and B are located at the rear of the **HeatMaster**® (see photo A and B below). Open both valves and allow the system to fill. When the combined temperature and pressure gauge shows the required pressure, close both valves. Replace the casing top front panel. Restore the power supply and switch the boiler on.



A



B

Safety Valves

If water discharges from any of the safety valves, switch the boiler off and call a service engineer.

SETTING THE PARAMETERS



Setting the temperature of the hot water:
(Temperature of the hot water)

- Press **"Mode"**: "PARA" comes up on the screen.
- Press **"Step"**: the first digit is 1 and the last two digits indicate the current temperature setting for the hot water.
- To change this temperature, press the "+" or "-" keys until the temperature indicated by the last two digits is the desired temperature.
- Press **"Store"** to save the setting.
- Press **"Mode"** twice to return to Standby mode (normal operating mode).

Enabling and disabling hot water mode:
(hot water)

- Press **"Mode"**: "PARA" comes up on the screen.
- Press **"Step"** twice: the first digit is 2 and the last two digits indicate the current setting:
00 = disabled; 01 = enabled.
- To change this parameter, press the "+" or "-" keys until you reach the desired value:
00 = disabled; 01 = enabled.
- Press **"Store"** to save the setting.
- Press **"Mode"** twice to return to Standby mode (normal operating mode).

Enabling and disabling central heating mode:
(heating)

- Press **"Mode"**: "PARA" comes up on the screen.
- Press **"Step"** three times: the first digit is 3 and the last two digits indicate the current setting:
00 = disabled; 01 = enabled.
- To change this parameter, press the "+" or "-" keys until you reach the desired value:
00 = disabled; 01 = enabled.
- Press **"Store"** to save the setting.
- Press **"Mode"** twice to return to Standby mode (normal operating mode).

Setting the temperature of the central heating:
(the maximum temperature for the heating circuit)

- Press **"Mode"**: "PARA" comes up on the screen.
- Press **"Step"** four times: the first digit is 4 and the last two digits indicate the current temperature setting for the central heating.
- To change this temperature, press the "+" or "-" keys until the temperature indicated by the last two digits is the desired temperature.
- Press **"Store"** to save the setting.
- Press **"Mode"** twice to return to Standby mode (normal operating mode).

Fault:

The temperature setting of the appliance and the safety functions of its parts are constantly monitored by a microprocessor controller (MCBA). In the event of a fault, this MCBA disables the appliance and displays an error code: the screen flashes and the first character is an "E" followed by the fault code, (see the list of faults on page 16).

Reset the appliance:

- Press **"Reset"** on the screen.
- If the fault code appears again, contact your installer.

Setting the temperature of the hot water

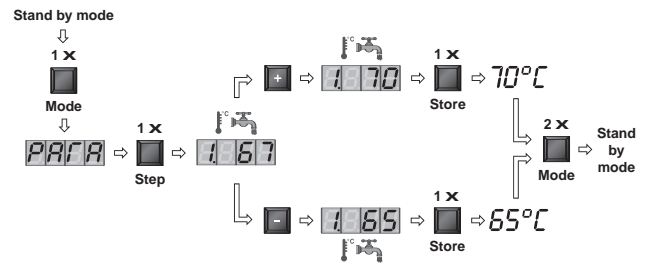

Enabling and disabling hot water mode

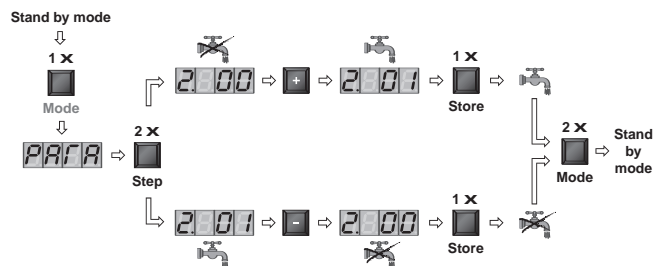

Enabling and disabling central heating mode

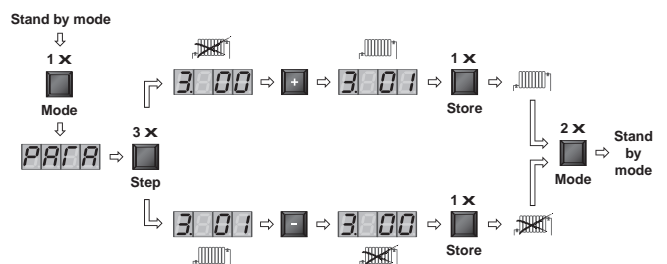

Setting the temperature of the central heating

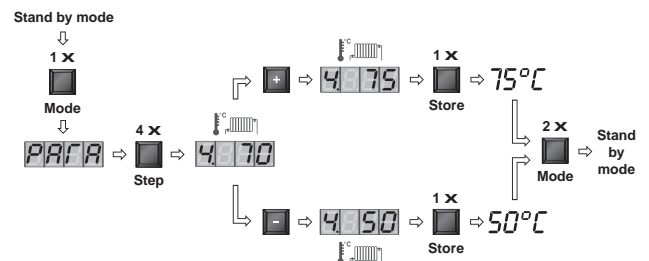

Fault

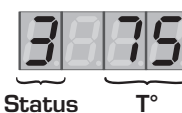

Reset the appliance



DESCRIPTION

OPERATING PRINCIPLE

The **HeatMaster®** is a high performance, direct fired hot water storage heater, which has indirect heat transfer due to its Tank-in-Tank construction.

At the heart of the **HeatMaster®** is a stainless steel cylinder through which the flue tubes pass. This is surrounded by a mild steel shell containing the primary water (*neutral fluid*). The outer shell extends down to the combustion chamber and even around the flue tubes. The area of the heat transfer surface is therefore much greater than that of standard direct fired water heaters.

A circulating pump fitted to the primary circuit moves the water around the tank, heating it faster and maintaining an even temperature across the primary jacket.

The burner heats the primary water, which indirectly heats the stainless steel tank containing the hot water. As in all Tank-in-Tank systems, the tank is corrugated over its full height and suspended in the **HeatMaster®** by its hot- and cold water connections.

The cylinder expands and contracts during use and this, together with the fact that cold water does not come into contact with the intense heat of the burner flame, means that limescale buildup is prevented.

This scale resistant feature, along with the corrosion resistance of stainless steel, eliminates the need for sacrificial anodes.

The **HeatMaster®** has one very major advantage over other direct fired water heaters - because it heats the DHW with a primary circuit, this primary water can be used to provide central heating as well.

By connecting two, three, four or more **HeatMaster®** together in a module, most hot water and heating demands can be met.

Indeed, when used in conjunction with HR and Jumbo hot water storage tanks the **HeatMaster®** can supply even the largest hot water requirement.

Standard equipment

The **HeatMaster®** 201 includes the following parts as standard:

- On/off switch
- Summer/Winter switch
- MCBA controller, including
 - an electronic controller
 - a low-water-level safety device
 - a burner modulator
- Primary circulating shunt pump
- Primary expansion vessels
- Primary safety valve
- Pressure and temperature gauge
- Drain valve
- Body completely insulated in rigid polyurethane foam

PACKING

The **HeatMaster®** is delivered in 4 separate packages.

- Package No. 1: Foam-insulated body, hydraulic accessories, and control panel.
- Package No. 2: Chimney reducing pipe.
- Package No. 3: The jacket.
- Package No. 4: The burner and its cover, the door insulation and the sealing cord.

CONSTRUCTION FEATURES

Outer body

The outer body containing the primary fluid is made of thick STW 22 steel.

TANK-IN-TANK heat exchanger

The ring-shaped inner tank with its large heating surface for producing domestic hot water is built of Chrome/Nickel 18/10 stainless steel. It is corrugated over its full height by an exclusive production process and entirely argon arc welded by the TIG (Tungsten Inert Gas) method.

Combustion gas circuit

The combustion gas circuit is paint-protected and comprises:

- **Flue pipes**

The **HeatMaster®** 201 range has 15 steel flue ways with an inside diameter of 64 mm. Each flue way has turbulators made of special stainless steel designed to improve the heat exchange and reduce the flue-gas outlet temperature.

- **Combustion chamber**

The combustion chamber on **HeatMaster®** models is entirely water cooled.

Insulation

The boiler body is fully insulated by rigid polyurethane foam with a high thermal insulation coefficient, sprayed on without the use of CFCs.

Casing

The boiler is covered by a steel jacket which has been scoured and phosphated before being stove enamelled at 220°C.

Burner

Models in the 201 range are always delivered with an ACV BG 2000-M 201 air-gas premix burner.

DESCRIPTION

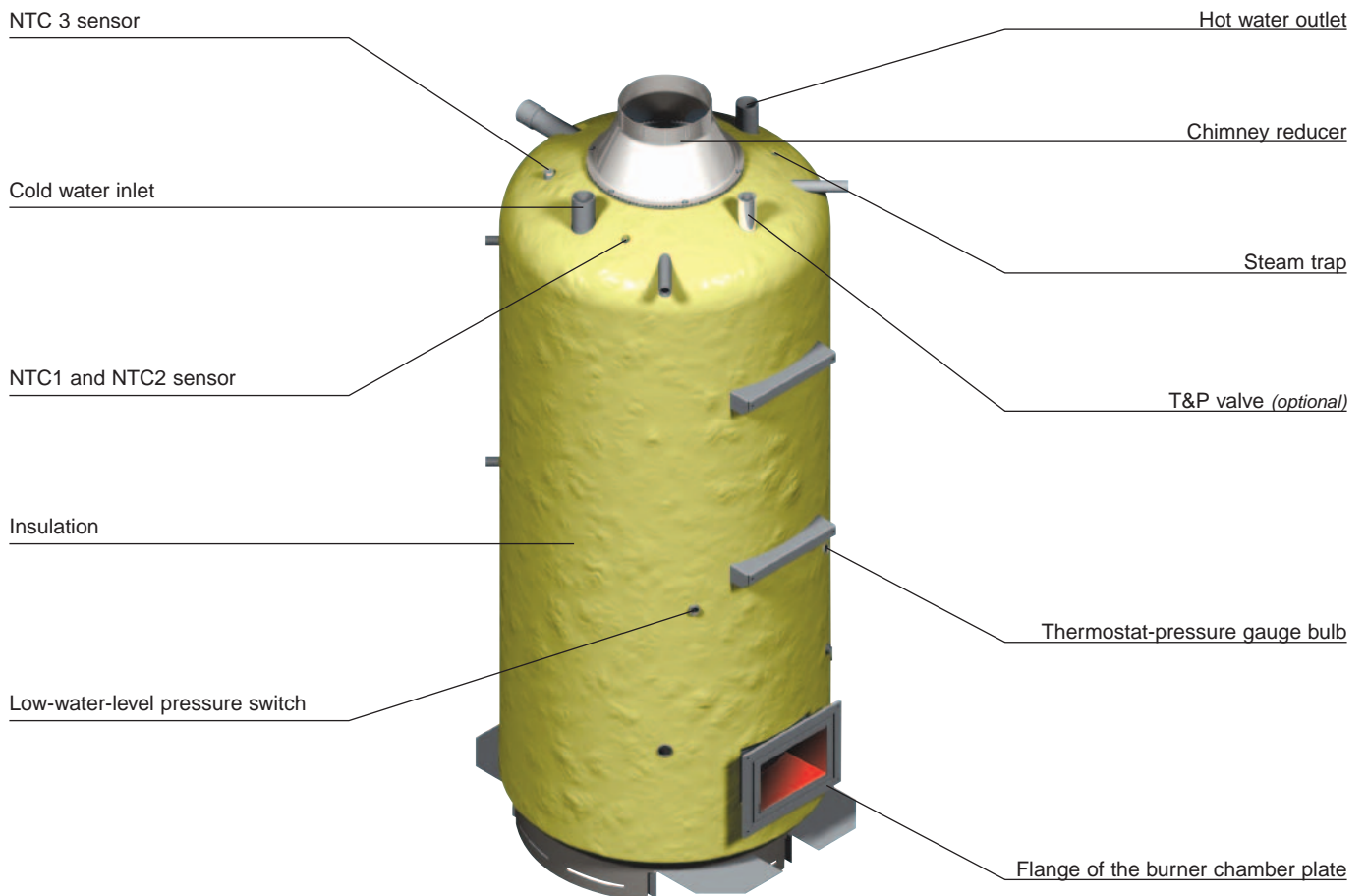
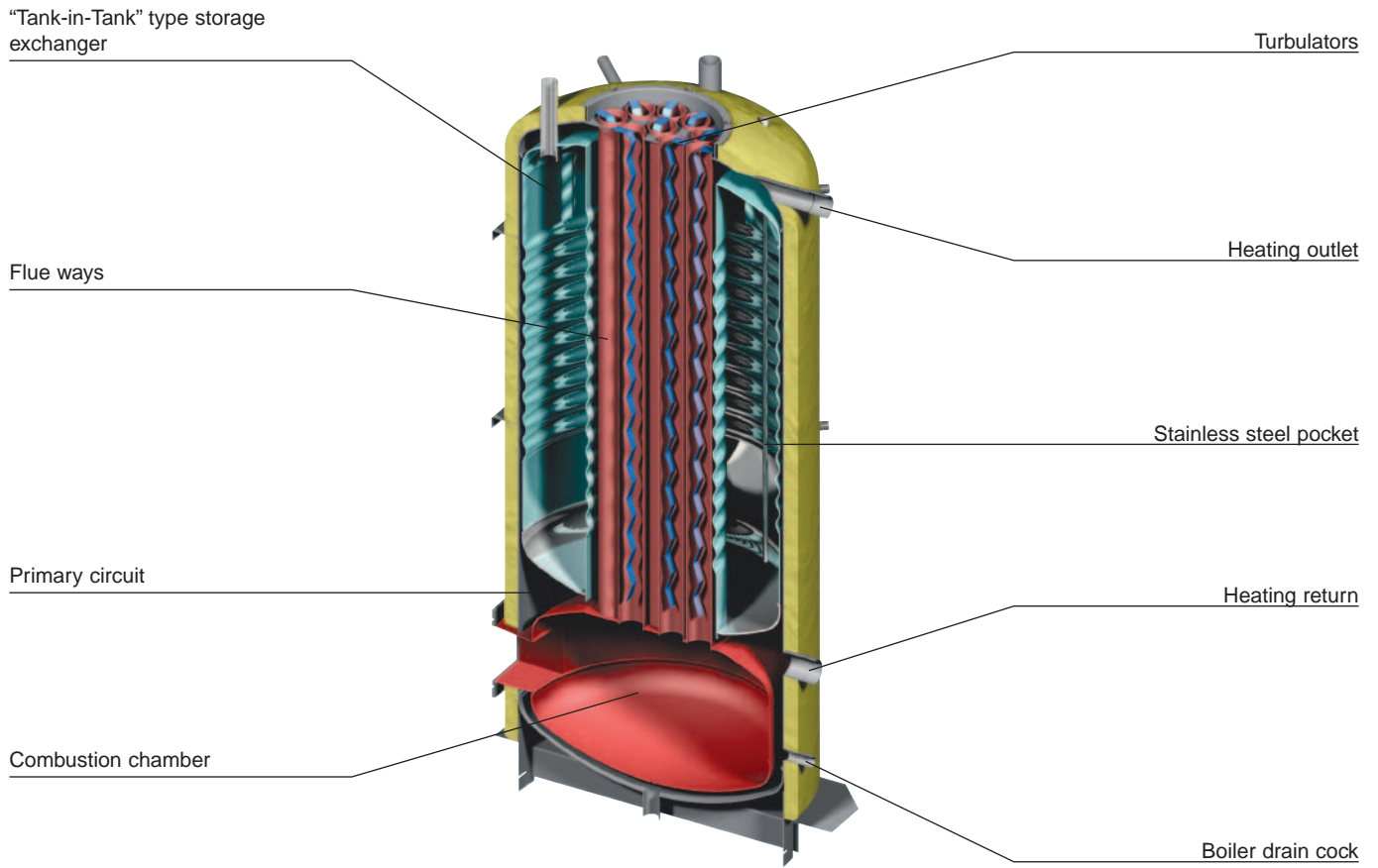

TECHNICAL SPECIFICATION

EFFECTIVE DIMENSIONS

The appliances delivered are factory-tested. Upon receipt, remove the packing and check that there is no damage to the appliances. Refer to the dimensions and weights listed below for transport purposes.

The jacket is fitted by the installer on site (see the assembly instructions in the wooden protective case).

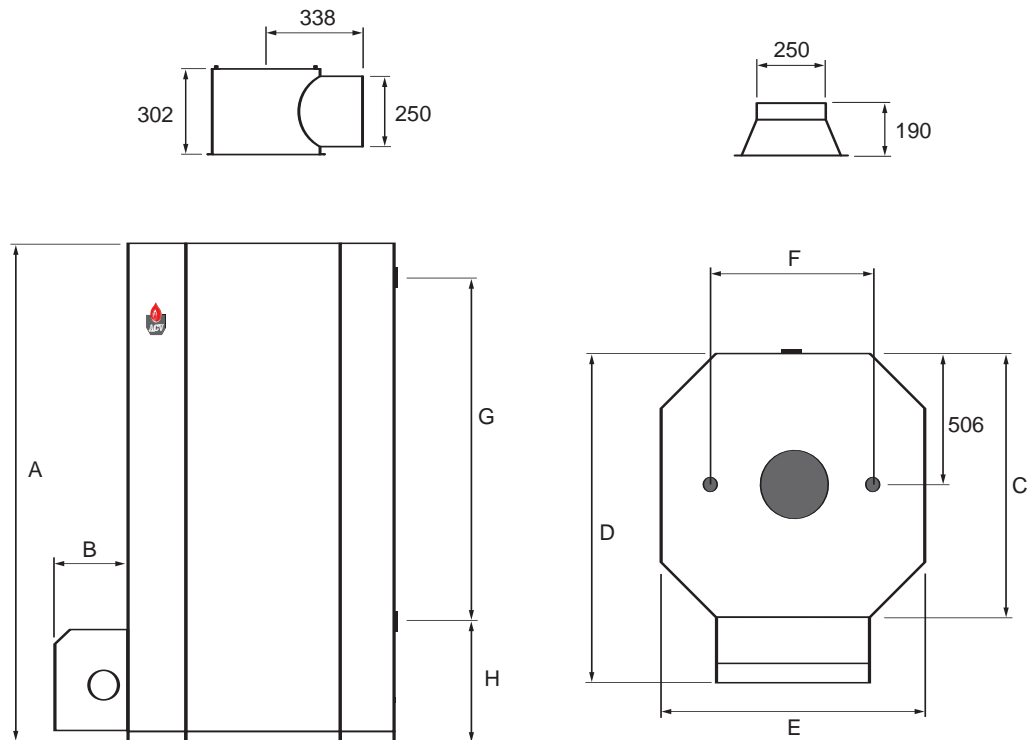

	A mm	B mm	C mm	D mm	E mm	F mm	G mm	H mm
HeatMaster® 201	2085	300	1020	1320	1020	600	1383	590

GENERAL CHARACTERISTICS

Type	HM 201		
Fuel	Natural gas/propane		
		Heating	Hot water
Maximum Input	kW	60 - 220	60 - 240
Maximum Output	kW	56.4 - 200.2	56.4 - 218.4
Maintenance loss at 60°C as rated value	%	0.3	
Total capacity	L	641	
Primary circuit capacity	L	241	
Heating connection	Ø	2"	
Hot water connection	Ø	2"	
Chimney connection	Ø mm	250	
Hot water tank heat exchange surface	m ²	5.30	
Weight empty	Kg	550	
Pressure drop primary circuit	mbar	240	

TECHNICAL SPECIFICATION

MAXIMUM OPERATING CONDITIONS

Maximum service pressure *(tank full of water)*

- Primary circuit: 3 bar
- Secondary circuit: 10 bar

Test pressure *(tank full of water)*

- Primary circuit: 4.5 bar
- Secondary circuit: 13 bar

Operating temperature

- Maximum temperature: 90°C

Water quality

- Chlorures: < 150 mg/l (304)
< 2000 mg/l (Duplex)
- $6 \leq \text{ph} \leq 8$

DOMESTIC HOT WATER PERFORMANCES

HM 201		
Peak delivery at 40°C	L/10'	1745
Peak delivery at 45°C	L/10'	1489
Peak delivery at 60°C	L/10'	971
Peak delivery at 70°C	L/10'	763
Peak delivery at 80°C	L/10'	586
Peak delivery at 40°C	L/60'	6690
Peak delivery at 45°C	L/60'	5667
Peak delivery at 60°C	L/60'	3534
Peak delivery at 70°C	L/60'	2554
Peak delivery at 80°C	L/60'	1723
Continuous delivery at 40°C	L/h	6117
Continuous delivery at 45°C	L/h	5039
Continuous delivery at 60°C	L/h	2914
Continuous delivery at 70°C	L/h	2128
Continuous delivery at 80°C	L/h	1468

N.B.:

The outputs above are given for a hot water temperature of 90°C and a cold water temperature of 10°C.

HEATMASTER® SETTING INSTRUCTIONS

Description

The HeatMaster® 201 range is equipped with an electronic controller (MCBA) which controls the burner (start-up, safety, and modulation) and allows the controller to be adapted to the selected application.

The MCBA system includes a controller with 3 levels for setting the parameters: manufacturer, installer, and user. It includes 3 temperature sensors located in the primary and secondary circuits.

There are two operating modes:

1. Heating mode

The T° is set by the user in the range 60 to 90°C.

- Differential "ON" starts the burner.
- Differential "OFF" stops the burner.
- PI controller (Proportional Integral) in "Heating" mode.
- The controller compares the primary temperature with the setting and the module.

The room thermostat detects the demand for heat.

2. Hot water mode *(with priority to the hot water)*

The T° is set by the user in the range 60 to 90°C.

The sensor located in the secondary tank detects the demand for hot water.

As soon as the draw-off is detected, the controller goes to "demand for hot water" mode:

- Differential "ON" starts the burner.
- Differential "OFF" stops the burner.
- PI controller (Proportional Integral) in "Hot water" mode.
- The controller compares the primary temperature with the setting and the module.
- The charging pump starts up.
- The heating circulator pump is no longer supplied.
- The burner starts and the controller controls the modulation based on the primary pump.

Parameters accessible by the user

1. "Hot water" temperature, which can be set to 20 - 90°C.
2. Hot water mode ON/OFF.
3. Heating mode: ON/OFF.
4. "Heating" temperature, which can be set to 60 - 90°C.

Parameters accessible for "service"

Main basic characteristics:

- Hot water priority active.
- Demand for heat detected by the room thermostat.
- Only one heating circuit.

An access code is required to access "Service" parameters.

Please see pages 17 to 19 for further details.

INSTALLATION

BOILER ROOM

Important

- Keep vents free at all times.
- Do not store inflammable products in the boiler room.
- Do not store corrosive products near the boiler, such as paints, solvents, chlorine, salt, soap and other cleaning products.
- If you smell gas, do not switch on the light or light a flame. Turn off the mains gas tap at the meter and inform the appropriate services immediately.

Access

The boiler room must be large enough to allow good access to the boiler. The following minimum distances are required around the boiler:

- front	500 mm
- side	100 mm
- behind	150 mm
- above	350 mm

Ventilation

The boiler room must have both low- and high-level ventilation, in accordance with the local standards and provisions force.

The table below gives an example conforming to the Belgian standards.

Ventilation		201
Min. fresh air requirement	m ³ /h	436
Bottom	dm ²	2.45
Top	dm ²	7.30

Other countries should refer to their own standards.

Base

The base on which the boiler rests must be made of non-combustible materials.

CHIMNEY CONNECTIONS



IMPORTANT

Boilers must be installed by an approved heating engineer, in accordance with the prevailing local standards and regulations.



The duct size may not be smaller than the boiler outlet duct.

Typical boiler connection: B23

The boiler is connected to the chimney by a metal pipe rising at an angle from the boiler to the chimney.

A flue disconnection piece is required.

This must be easy to remove to give access to the flue pipes when servicing the boiler.

Chimney / minimum flue diameter	201
E = 5 m Ø F min.	mm 350
E = 10 m Ø F min.	mm 300
E = 15 m Ø F min.	mm 270



Note:

Regulations vary from country to country therefore the table above is intended only as a guide.



Due to the high efficiency of our boilers, the flue gasses exit at low temperature. Accordingly, there is risk that the flue gasses could condense, which could damage the chimney. In order to avoid this risk, it is strongly recommended that the chimney be lined.

Connecting the boiler to an air vent type: C

- C53: parallel connection
total loss of pressure (air intake + flue-gas discharge) may not exceed 250 Pa. See the table below showing the pressure drops for the various components.



A condensation drain outlet must be fitted close to the boiler to prevent condensation products from the chimney running into the boiler.



To avoid condensation water running out of the terminal, all horizontal flue runs must fall back towards the boiler.

- A. Top vent
- B. Bottom vent
- C. Draught regulator
- D. Inspection window
- E. Height of lined chimney
- F. Chimney diameter

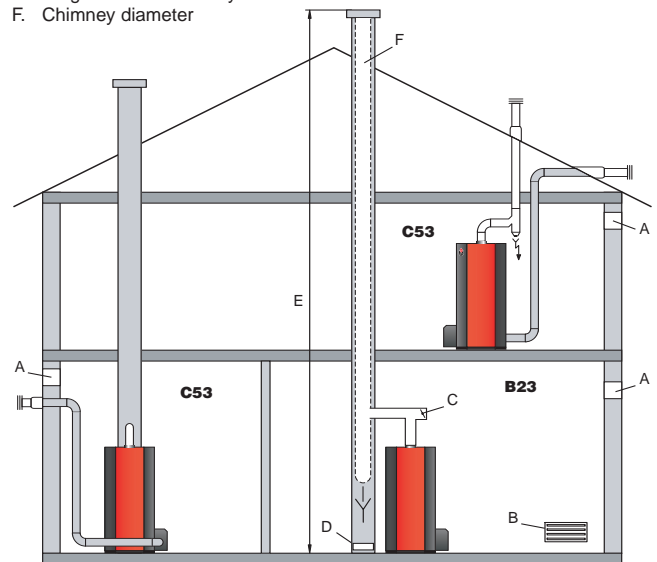

	Air Ø 100 mm	Flue gas Ø 250 mm
Pipe, L. 1000mm	18.0	1.0
90° bend	70.0	3.0
45° bend	28.0	-
Condensates trap	-	5.0
Terminal	50.0	3.0



When connecting the flue gas outlet to an existing chimney, do not take into account the pressure drop on the "flue gas side".

HOT WATER CONNECTIONS

Pressure reducing valve

If the mains water pressure is greater than 6 bar, a pressure reducing valve must be fitted.

Expansion relief valve

The tank expansion relief valve must be ACV approved and calibrated to a maximum of 7 bar. The valve discharge must be connected to the drain.

Hot water expansion vessel

A hot water expansion vessel must be installed.

Hot water circulation

If the tank is situated a long way from the point of use, then installing a recirculation loop can provide a faster supply of hot water to the outlets.

Temperature and pressure relief valve

If using the HeatMaster as an unvented hot water unit, in some countries, a temperature and pressure relief valve must be fitted - consult your ACV stockist for assistance.

Example of hot water connection with thermostatic mixer

1. Stop cock
2. Non-return valve
3. Pressure reducing valve
4. Expansion relief valve
5. Hot water expansion vessel
6. Hot water secondary pump (if fitted)
7. Thermostatic mixing valve
8. Drawoff tap
9. Drain cock
10. Stop cock for cleaning
11. Temperature relief valve (UK-only)

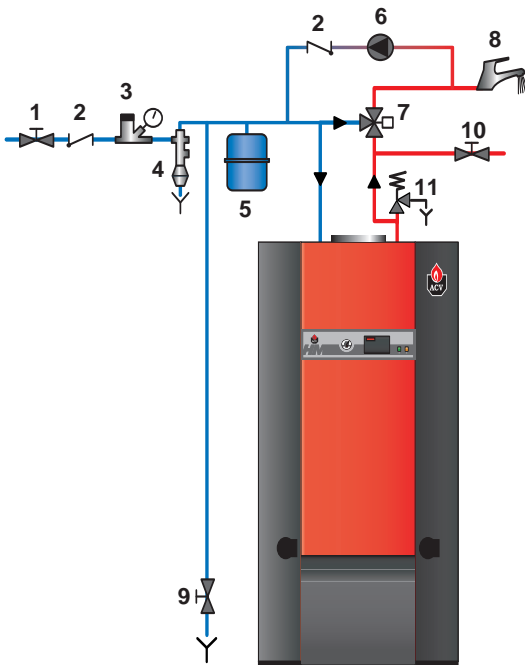

DANGER!
As a safety measure, we strongly advise installing a thermostatic mixer to prevent the risk of burns.

Example of parallel connection

Recommended for applications with a high continuous flow.

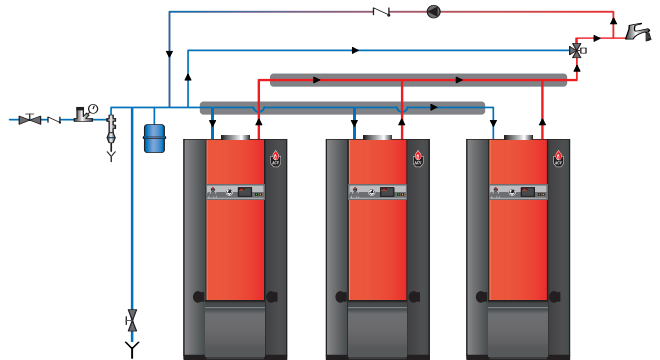

Example of series connection

Preferable for high temperature applications with up to three units.

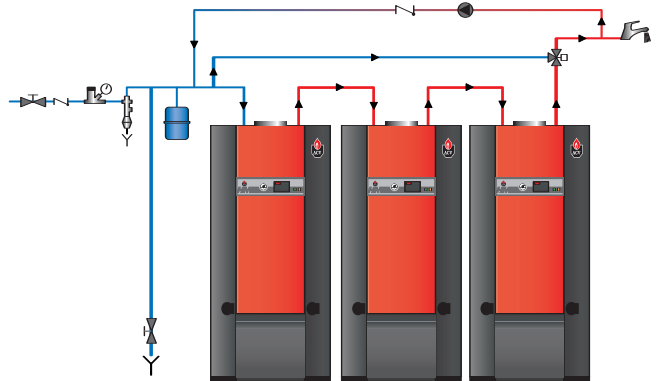

Example of heating + storage connection

Recommended for applications requiring a high peak flow.

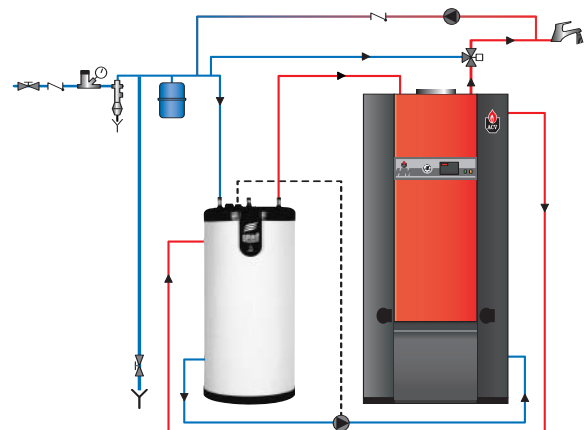

INSTALLATION

HEATING CONNECTION

The **HeatMaster®** has two connections at the rear that can be used to connect a central heating circuit. Connecting a heating system may reduce the domestic hot water performance.



WARNING

The power supply to the heating pump for the MCBA is limited to 250W. In the event of a higher wattage, provide a relay between the pump and the MCBA.

Expansion

The **HeatMaster®** 201 models are equipped with 4 8-litre expansion vessels. These expansion vessels are sized for hot water operation only. If a heating system is connected to the primary circuit, calculate the expansion capacity necessary for the total volume of the heating system. (Refer to the technical instructions from a relevant manufacturer of expansion vessels).

Example of a single circuit connection

1. 4-way valve
2. Heating pump
3. Non-return valve
4. Isolating valves
5. Safety valve set to 3 bar with pressure gauge
6. Expansion vessel
7. Drain cock
8. MCBA controller, module AM3-11
9. Surface-mounted sensor (optional)

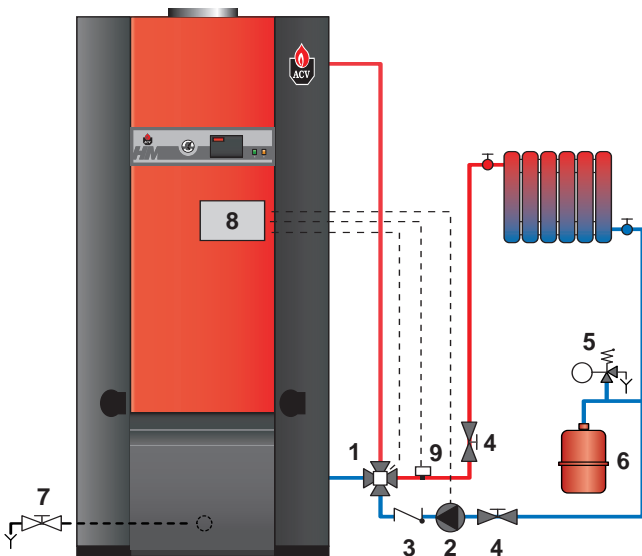

WARNING

The primary safety valve is supplied with a plastic tube connected to the discharge outlet - this is for test purposes only and should be removed. The safety valve should be connected to a drain using a metallic pipe eg. copper.

WARNING

In the case of heating at low temperature, the use of the kit (code: 10800099) is required.

ELECTRICAL CONNECTIONS

Electrical supply

The boiler operates on a single-phase supply of 230V/50Hz. You should install a control box with a double-pole switch and a 6 A fuse or a 6A circuit breaker externally to the boiler to allow the boiler to be isolated from the power supply for servicing and repairs.

Conformity

Boiler installation must comply with the prevailing local standards and legislation.

Safety

The stainless steel tank must be earthed separately.



The power to the boiler must be switched off before any work is carried out.

HeatMaster® 201 wiring diagram key

01. Main switch
02. Module AM3-11
03. Module AM3-2
04. MCBA
05. 24V transformer
06. Display
07. Room thermostat
08. Low-water-level safety device
09. NTC1 primary temperature sensor
10. NTC2 primary temperature sensor
11. NTC3 hot water temperature sensor
12. NTC4 outdoor sensor (optional)
13. Summer/Winter switch
14. NTC6 heating outlet sensor (optional)
15. Communication bus
16. Heating circulator pump (not supplied)
17. Heating circulator pump (not supplied) for use with 3-way power-operated valve
18. Charging pump
19. Charging pump
20. 3-way power-operated valve
21. Alarm switch
22. Outside gas valve/burner operation switch
23. Hot water mode operating switch
24. Fan (BG 2000-M / 201)
25. Gas valve (BG 2000-M / 201)
26. Gas pressure switch (BG 2000-M / 201) (optional)
27. Charging circulator pump control relay

Note: The switches have zero voltage.

HeatMaster® 201 wiring

B.	Blue
Br.	Brown
Bk.	Black
Or.	Orange
G.	Grey
R.	Red
W.	White
Y.	Yellow
V.	Violet

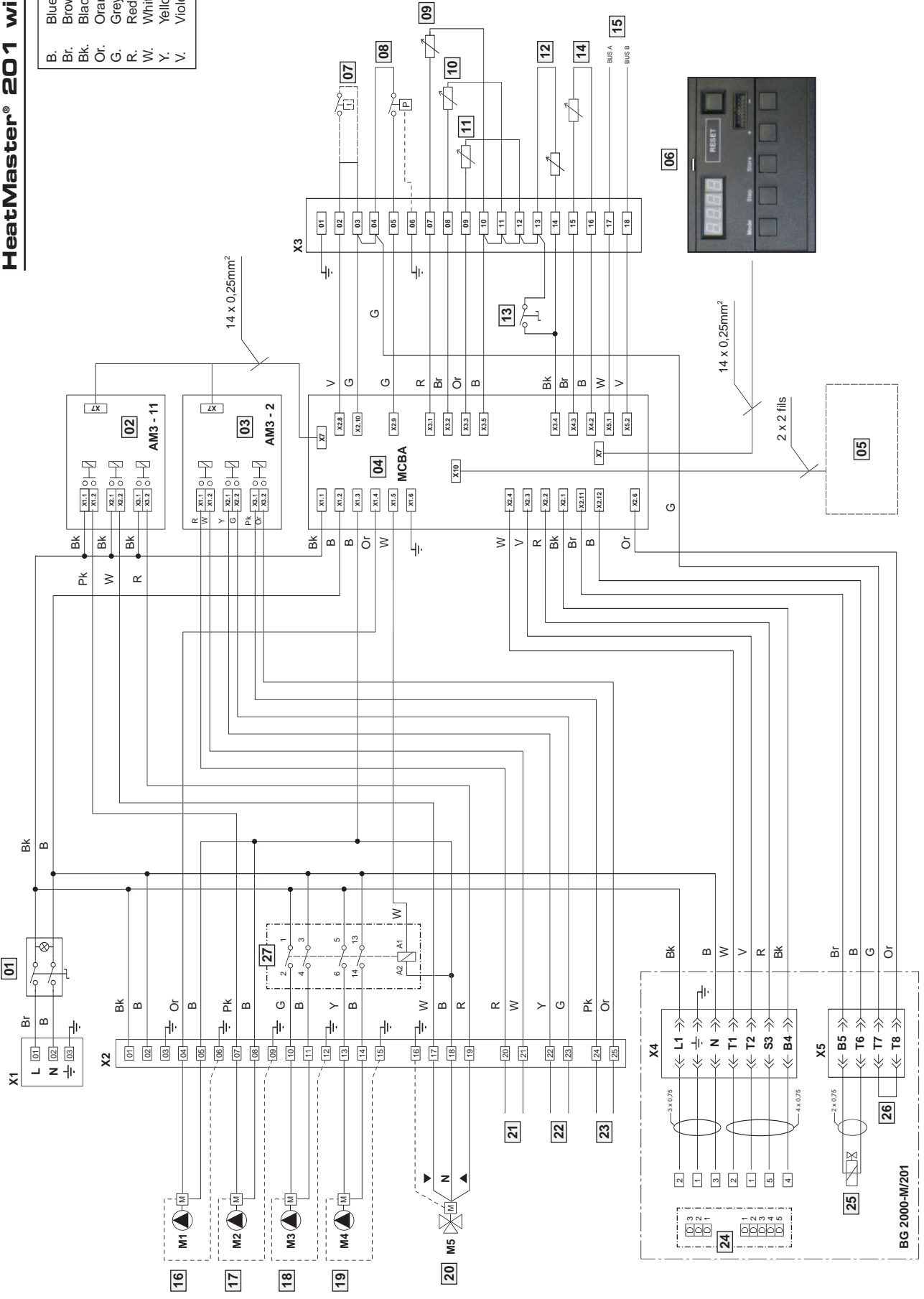

FILLING THE HOT WATER AND HEATING CIRCUITS



IMPORTANT
Hot water tank must be pressurised before the heating circuit is filled.

1. Close the primary circuit filling valves (A and B)
2. Open the stop valve (1) and the draw-off tap (8). Fill the tank with the water from the tap; close the draw-off tap (8).
3. Fill the primary (heating) circuit by opening the valves (A and B) and pressurising to 1 bar.

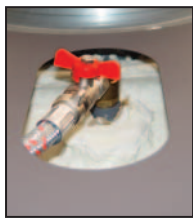

A



B

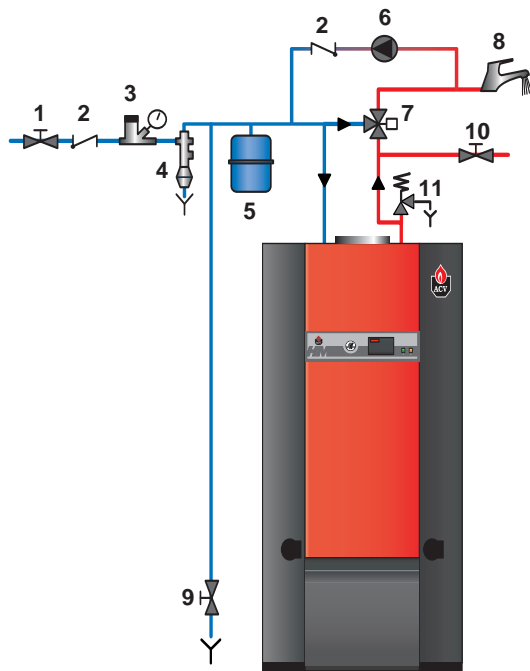

4. Open the automatic air vent located on top of the boiler.
IMPORTANT - the screw cap must be left loose to allow future automatic venting to take place.
5. After venting the air from the system, bring the pressure up to the static head plus 0.5 bar: 1.5 bar = 10 m and 2 bar = 15 m.
6. Check that the electrical connection and boiler room ventilation conform to the relevant standards.
7. Switch the on/off switch to the ON position.
8. Set the temperature values (see page 17).
9. Check the gas supply pressure (see page 13).
10. When the burner is on, check that the flue gas discharge pipes are completely gas tight.
11. After operating for five minutes, turn off the boiler and drain the heating circuit again, maintaining a pressure of 1 bar.
12. Turn the appliance back on and check the combustion (see page 13).

ACV BG 2000-M MODULATING PREMIX GAS BURNER

Description and operating method:

The BG 2000-M modulating burner's output is constantly adjusted to suit the fluctuating demand for heat, thus optimising operating efficiency.

The gas tube is covered with a metal fibre (NIT), which, in addition to its outstanding heat-exchange properties, increases its life.

The main parts are a venturi and a valve, a unit developed specially by Honeywell for low NOx air/gas premix burners with automatic ignition and flame detection by ionisation.

The pressure at the gas valve outlet is equal to the air pressure in the neck of the venturi, less the offset. The fan sucks combustion air through the venturi, into which the gas inlet emerges.

As it passes through, the air produces a pressure differential in the constriction of the venturi and sucks the gas into the venturi outlet. A perfect mix of air and gas then passes through the fan to the burner tube.

This design ensures very quiet and safe operation:

- If there is an air blockage, the pressure differential in the venturi falls, the gas flow diminishes, the flame goes out and the gas valve closes: the burner is in safety shutdown mode.
- If there is a blockage in the chimney outlet, the air flow diminishes, and the same reactions as those described above cause the burner to shut down in safety mode.
- The BG 2000-M burner on the HeatMaster® 201 is controlled by an MCBA controller (Honeywell), which controls the safety of operation of the burner and its modulation according to the temperature.

The BG 2000-M burners are factory-set for natural gas.

Air/gas mixture control system

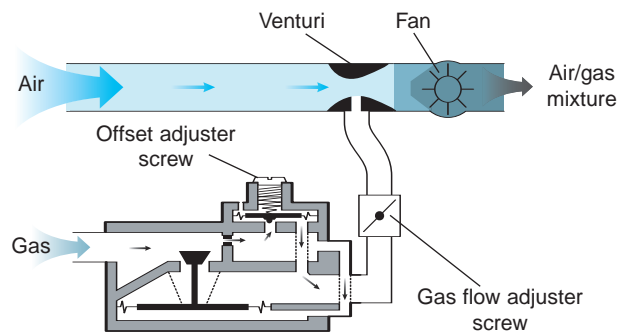

201 gas burner characteristics

Type		Heating	Hot water
Input	Kw	60 - 220	60 - 240
Nominal output	Kw	56.4 - 200.2	56.4 - 218.4
Combustion efficiency - natural gas	%	96.6 - 91.5	96.6 - 91.5
Natural gas CO ₂	%	9	9
Pressure loss of the flue-gas circuit	mbar	2.4	2.9
Net T° of combusted gases	°C	180	190
Mass flow rate of combustion products	g/sec.	110.3	120.3
Gas G20 - 20 mbar - I 2E(R)B - I 2 Er - I 2H - I 2E - I 2ELL			
Flow	m ³ /h	6.35 - 23.28	6.35 - 25.40
Gas G25 - 20 mbar - I 2ELL / 25 mbar - I 2L			
Flow	m ³ /h	7.38 - 27.08	7.38 - 29.54
Gas G31 - 30/37/50 mbar - I 3P			
Flow	m ³ /h	2.45 - 9.00	2.45 - 9.81
CO ₂	%	11.0 - 11.2	11.0 - 11.2

Gas category

	BE	FR	AT	DK	ES	UK	IT	PT	IE	SE	NL	LU	DE
I 2Er		X											
I 2E(R)B	x												
I 2H			X	X	X	X	X	X	X	X			
I 3P	X	X			X	X		X	X				
I 2L										X			
I 2ELL													X
I 2E												X	

BG 2000-M/201

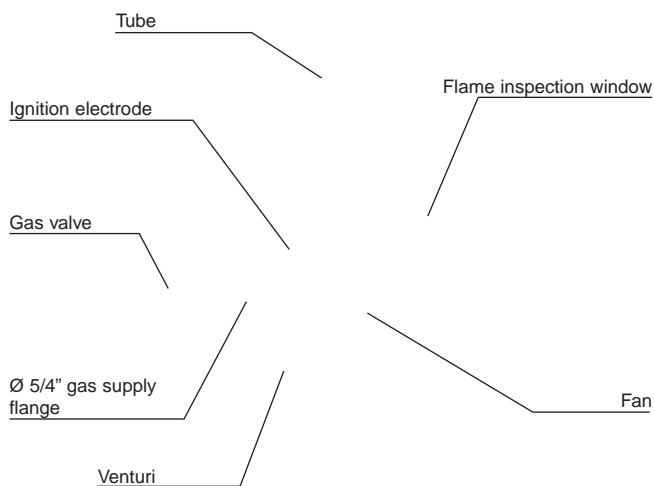

Burner adjustment (Prohibited in Belgium).

With the burner operating at full power, the CO₂ must be in the range 8.8 to 9.2 % (natural gas) or 10.5 to 10.6 % (propane).

If necessary, adjust the CO₂ by turning the screw clockwise to reduce it and counter-clockwise to increase it. (see photo opposite).

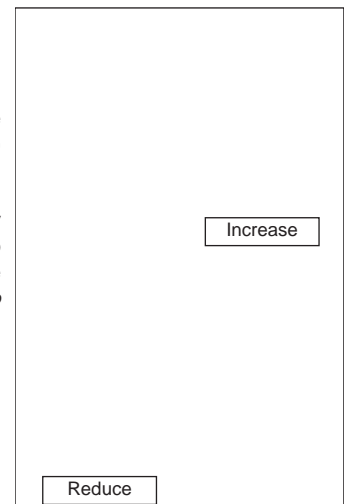

MAINTENANCE

SERVICE INTERVALS

ACV recommends that boilers should be serviced at least once a year. The burner must be serviced and tested by a competent engineer. If a boiler is subject to heavy use, it may require servicing more than once a year - consult ACV for advice.

SERVICING THE BOILER

1. Turn OFF the on/off switch on the boiler control panel and isolate external electrical supply.
2. Turn off the gas or oil supply to the boiler.

Vertical flue-gas outlet reducer

3. Take down and remove the flue lining to release the top of the boiler.
4. Loosen the nuts and remove the chimney reducer.
5. Take out the turbulators from the flue ways to clean them.
6. Dismantle the chamber plate and remove the burner.
7. Brush the flue ways.
8. Clean the combustion chamber and the burner.
9. Replace the turbulators, the chimney reducer, and the flue lining; check that the seal on the chimney reducer is in good condition. Replace the seal if necessary.

Horizontal flue-gas outlet reducer

3. Loosen the nuts and remove the chimney reduction.
5. Take out the turbulators from the flue ways to clean them.
6. Dismantle the chamber plate and remove the burner.
7. Brush the flue ways.
8. Clean the combustion chamber and the burner.
9. Replace the turbulators, the chimney reducer, and the flue lining; check that the seal between the chimney reducer and the chimney is in good condition. Replace the seal if necessary.

SERVICING THE SAFETY DEVICES

- Check that all thermostats and safety devices are working properly.
- Test the safety valves on the central heating and hot water circuits.

SERVICING THE BURNER

- Check that the insulation and the seal on the chamber plate are in good condition; replace them if necessary.
- Check and clean the burner and the electrodes. Replace the electrodes if necessary (1 x per year in normal usage conditions)
- Check that the safety devices are in good working order.
- Check the combustion (CO₂, CO, and gas pressure) and record the values and any other comments on page 23 of the service record.

DRAINING THE BOILER



Water flowing out of the drain cock may be extremely hot and could cause severe scalding. Keep people away from discharges of hot water.

Draining the boiler's primary circuit

1. Put the main switch on the control panel to OFF, cut the outside power supply and close the gas-supply valve to the boiler.
2. Close the isolating valves (4) or manually set the 4-way valve (1) to "0".
3. Connect a flexible tube to the drain cock (7). Make sure it is properly connected.
4. Open the drain cock and allow the hot water to flow into the drain.

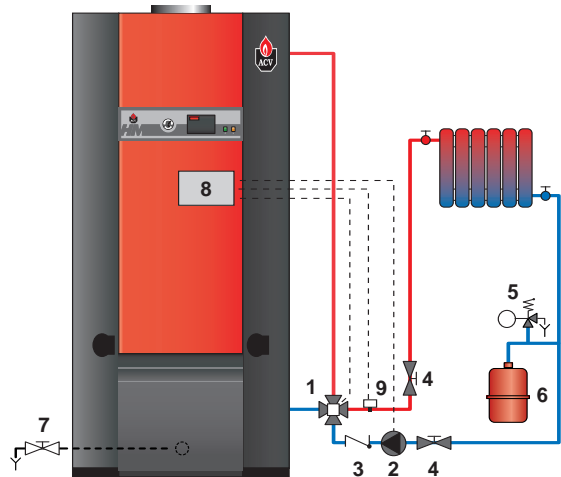

Drain the hot water circuit.

1. Put the main switch on the control panel to OFF, cut the outside power supply and close the gas-supply valve to the boiler.
2. Release the pressure in the heating circuit until the pressure gauge reads zero.
3. Close the cocks (1 and 8).
4. Open valve (9) and then (10).
5. Allow the hot water to flow into the drain.

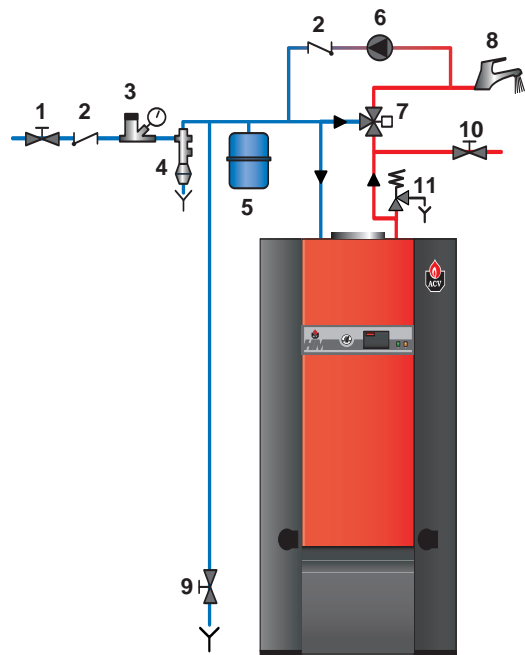

The drain cock (9) must be at ground level for the circuit to drain fully.

MCBA FOR SPECIALISTS: INSTALLER, SERVICE ENGINEER

PILOT MODE

Pilot mode

Stby

After you power down the appliance the screen displays Pilot mode, as shown in the figure above.

This is the standard MCBA mode. The MCBA automatically returns to this mode after 20 minutes if no keys have been pressed on the screen. Any parameters that were modified are then enabled.

The first character shows the current status of the boiler depending on the condition of both the boiler and the burner. The last 2 characters indicate the start temperature.

Status	Boiler function
0 000	Pilot, no demand for heat
1 000	Fan first, fan after
2 000	Ignition
3 000	Operation of the boiler burner for the heating
4 000	Operation of the boiler burner for the domestic hot water
5 000	Air pressure limit or obtaining the number of start revolutions.
6 000	The burner goes out when the specified value is reached. A demand for heat is present nonetheless.
7 000	Pump over-run time after the demand for domestic hot water
8 000	Pump over-run time after the demand for central heating
9 000	Burner blocked: <ul style="list-style-type: none"> • b 18: T1 > 95°C • b 19: T2 > 95°C • b 24: T2 - T1 > 10.20 or 40°C after a time of xx • b 25: dT1/dt > maximum gradient T1 • b 26: water pressure switch not off • b 28: no fan signal • b 29: erroneous fan signal • b 30: T1 - T2 > max Delta • b 33: NTC3 short-circuit • b 38: NTC3 interrupt • b 65: wait for the fan to start

If the burner is blocked for one of the reasons mentioned above, the screen display alternates between a 9 followed by the temperature (two last digits) and b with the error code.

Once the cause of the blockage has been resolved, the burner starts automatically within 150 seconds at most.

Status	Boiler function
A 000	Internal check — three-way valve
C 000	Boiler burner in hot water ready function
H 000	Test function: Central heating high power
L 000	Test function: Central heating low power
E 000	Test function: Boiler with fixed number of revolutions

MCBA FOR SPECIALISTS: INSTALLER, SERVICE ENGINEER

SAFETY STOP (ERROR MODE)

If a fault occurs while the appliance is running, the system locks and the screen starts to flash. The first character is an E and the next two characters give the code for this fault, as illustrated in the table below.



To unlock the system:

- Press **RESET** on the screen.
- Contact your installer if the fault happens again.

Table of error codes and how to resolve them

Codes	Description of the fault	Resolution of the fault
	Abnormal flame signal	<ul style="list-style-type: none"> - Check the wiring (<i>short-circuit in the 24V wiring</i>) - Check the electrode/ replace the MCBA (<i>water damage</i>).
	No flame signal after five attempts at firing the boiler	<ul style="list-style-type: none"> - Check the ignition cable, the electrode and the position of the electrode. - Check that there is gas at the burner.
	Persistent lock	- Press RESET
	EPROM error	-If the problem persists after two RESET attempts, replace the MCBA.
	Max input, thermostat open or 24V fuse gone.	- Check the wiring and check the 24V fuse on the MCBA.
 To 	Internal error	- If the problem persists after two RESET attempts, replace the MCBA.
	T1 > 110°C	- Check the NTC wiring and replace if necessary.
	T2 > 110°C	- Check the NTC wiring and replace if necessary.
	T1 gradient too high	- Check that the pump is turning. If there is no problem with the pump, drain the system.
	No fan signal present	<ul style="list-style-type: none"> - If the fan is working: <ul style="list-style-type: none"> • Check the fan control connection and the fan wiring • if the problem persists after 2 RESET attempts, replace the fan • if the problem persists, replace the MCBA. - If the fan is not working: <ul style="list-style-type: none"> • Check that the fan 230V connection. If the problem persists, replace the fan.
	NTC 1 short-circuit	- Check the connection and the NTC1 wiring If the problem persists, replace the NTC1.
	NTC 2 short-circuit	- Check the connection and the NTC2 wiring If the problem persists, replace the NTC2.
	NTC 3 short-circuit	- Check the connection and the NTC3 wiring If the problem persists, replace the NTC3.
	NTC 1 connection open	- Check the connection and the NTC1 wiring If the problem persists, replace the NTC1.
	NTC 2 connection open	- Check the connection and the NTC2 wiring If the problem persists, replace the NTC2.
	NTC 3 connection open	- Check the connection and the NTC3 wiring If the problem persists, replace the NTC3.
	Internal error	- If the problem persists after two RESET attempts, replace the MCBA.
	Error while reading the parameters	Press RESET. If the error persists, replace the MCBA.
	Problem with the power supply to the fan	Check the MCBA power supply voltage. If it is OK, replace the fan.

SETTING THE PARAMETERS





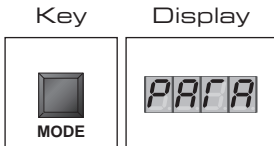

Parameter mode **PARA**

To access Parameter mode when the system is in Pilot mode, press **MODE** once.

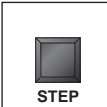

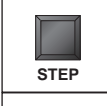

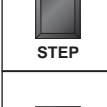
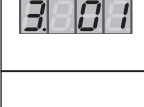

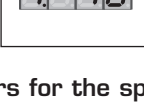

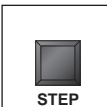
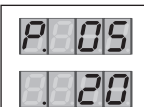
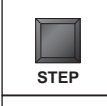
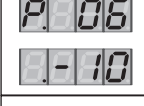
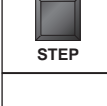

To scroll through the list of parameters, simply press "**step**". To modify a parameter value, use the **+** or **-** keys. Then press "**Store**" to save the value you just changed. The screen flashes once to confirm the data has been saved.

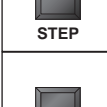
To activate the parameters you changed, press "**Mode**" once more (which brings you into Info mode). However, if you do not press a key, the system returns to Pilot mode after 20 minutes and automatically enables the changes.

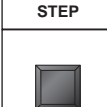

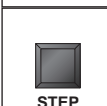















Key	Display	Description of parameters	Factory setting
 STEP		Adjusting the hot water temperature	90
 STEP		Production of hot water 00 = Stop 01 = Start 02 = Stop + pump continuously on 03 = Start + pump continuously on	01
 STEP		Turn on/Turn off the heating 00 = Stop 01 = Start 02 = Stop + pump continuously on 03 = Start + pump continuously on	01
 STEP		Maximum temperature in Central Heating mode	90















Parameters for the specialist: only accessible by using the Code

Key	Screen	Description of parameters	Factory setting
 STEP		Minimum central heating temperature when using an outdoor sensor	60
 STEP		Minimum outdoor temperature (adjust the heating curve)	0
 STEP		Maximum outdoor temperature (adjust the heating curve)	20
 STEP		Frost protection temperature	- 15
 STEP		Correction based on the outdoor temperature	00
 STEP		Blockage T 0 = Disabled	00
 STEP		Booster 00 = Stop (minute)	00

MCBA FOR SPECIALISTS: INSTALLER, SERVICE ENGINEER

Key	Display	Description of the parameters	Factory setting
 STEP	P. 12 15	Night-time heating temperature reduction (°C)	10
 STEP	P. 13 59	Fan speed in heating mode (rpm x 100)	52
 STEP	P. 14 00	Max. fan speed in heating mode (rpm x 100)	00
 STEP	P. 15 59	Max fan speed in hot water mode (rpm x 100)	57
 STEP	P. 16 00	Max. fan speed in hot water mode (rpm x 100)	00
 STEP	P. 17 16	Min. fan speed (rpm x 100)	15
 STEP	P. 18 00	Min. fan speed (rpm x 100)	00
 STEP	P. 19 35	Fan speed at ignition (rpm x 100)	37
 STEP	P. 20 10	Heating pump time delay 0 = 10 sec (minute)	00
 STEP	P. 21 30	Hot water pump time delay 10.2 = 10 sec (minute)	16
 STEP	P. 22 05	Burner interlock hysteresis (heating)	00
 STEP	P. 23 05	Burner trigger hysteresis (heating)	01
 STEP	P. 24 05	Burner interlock hysteresis (hot water)	01
 STEP	P. 25 05	Burner trigger hysteresis (hot water)	03
 STEP	P. 26 03	Hot water mode interlock hysteresis	04
 STEP	P. 27 03	Hot water mode trigger hysteresis	01

MCBA FOR SPECIALISTS: INSTALLER, SERVICE ENGINEER

Key	Display	Description of the parameters	Factory setting
 STEP	P. 28 00	Heating lock time (sec x 10.2)	00
 STEP	P. 29 00	Hot water lock time (sec x 10.2)	00
 STEP	P. 30 06	Lock time to switch from hot water mode to heating mode (sec x 10.2)	00
 STEP	P. 31 25	Difference T1 - T2 for modulation	05
 STEP	P. 32 -01	BUS address (-1 = disabled)	- 01
 STEP	P. 33 20	Increase the primary temperature value to generate hot water (relative to the hot water temperature)	05
 STEP	P. 34 00	1st digit: heating circuit (AM3-11 – 4-way valve) 0 = disabled 5 = enabled 2nd digit: the demand for heat comes from: 0 = room thermostat	00
 STEP	P. 35 03	1st digit: Hot water circulator pump (= 1) 2nd digit: tank with NTC3 sensor (= 2)	12
 STEP	P. 36 -01	Manual fan speed (- 01 = modulation)	- 01
 STEP	P. 37 41	1st digit: PWM pump operating speed 2nd digit: PWM pump speed during time-delay	11
 STEP	P. 38 00	Holding temperature	00
 STEP	P. 39 35	Maximum temperature for the heating circuit outlet (AM3-11 – 4-way valve)	60
 STEP	P. 40 10	Minimum temperature for the heating circuit outlet (AM3-11 – 4-way valve)	30
 STEP	P. 41 01	Hysteresis of the heating circuit outlet temperature (AM3-11 – 4-way valve)	01
 STEP	P. 42 00	1st digit: Special pump (0 = disabled) 2nd digit: Minimum disable cycle (0 = disabled)	00

MCBA FOR SPECIALISTS: INSTALLER, SERVICE ENGINEER

ENTERING THE CODE

Code mode

You can access the following parameters by entering the service code:

- Parameters 5 - 42
- Communication mode
- Fan Speed mode
- ERROR mode

To access Code mode, press **MODE** and **STEP** simultaneously (only from Pilot mode!).

Press "**STEP**" once and the system displays "**C**" in position 1, followed by arbitrary characters in positions 3 and 4.

Press "+" or "-" to change the code.

Press "**STORE**", the screen flashes briefly to indicate that the code has been accepted.

Press "**MODE**" until the system displays the correct mode.

Only ACX authorised installers know the access code.

For further information, please contact our after-sales department.

INFORMATION ON THE INSTALLATION

Info mode

To switch from Pilot mode to Info mode, press "**Mode**" twice.

Key	Display

Press "**STEP**" until the system displays the information you need. The point located behind the first position flashes to indicate that the boiler is in "**INFO**" mode.

Key	Display	Description of parameters
		Start temperature T1 in °C
		Return temperature T2 in °C
		Hot water temperature T3 in °C
		Outdoor temperature T4 in °C
		Not used
		Start temperature calculated in °C
		Rate of increase in the start temperature in °C/s
		Rate of increase in the return temperature in °C/s
		Rate of increase in the hot water temperature in °C/s
		Heating circuit outlet temperature (AM3-11 – 4-way valve)

MCBA FOR SPECIALISTS: INSTALLER, SERVICE ENGINEER

COMMUNICATION MODE (WITH CODE)

When in this mode, the system displays the communication between the boiler and the control module, the optional interface kit or the optional programmable room thermostat.

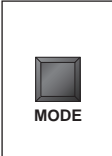
Key	Display
	CONN

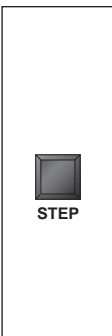
Key	Display	Description of parameters
	----	No communication
	!---	Communication between the boiler module and the optional control modules only (RMC1)
	!-!-	Communication between all the devices connected

FAN MODE (WITH CODE)

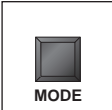
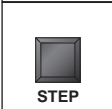
Key	Display	Description of parameters
	FAN	Fan speed
	5500	The current fan speed is 5,500 rpm.

ERROR MODE (WITH CODE)

"ERROR" mode indicates the most recent error, as well as the status of the boiler and its readings at the time this error occurred.

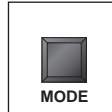
Key	Display
	ERR0

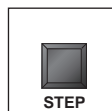
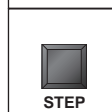
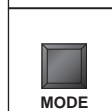
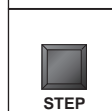
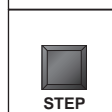
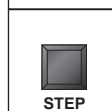
Key	Display	Description of parameters
	1:36	Code mode (See the table on page 16 for a full list)
	2:00	Status of the boiler at the time of the error (See the table on page 16)
	3:00	Start temperature T1 at the time of the error
	4:00	Return temperature T2 at the time of the error
	5:00	Hot water temperature T3 at the time of the error
	6:00	Outdoor temperature T4 at the time of the error

Temperature sensor resistance tables

Temp. °C	R Ω	Temp. °C	R Ω
-20	98200	40	6650
-15	75900	45	5520
-10	58800	50	4610
-5	45900	55	3860
0	36100	60	3250
5	28600	65	2750
10	22800	70	2340
15	18300	75	1940
20	14700	80	1710
25	12000	85	1470
30	9800	90	1260
35	8050	95	1100
		100	950

SPARE PARTS

No.	Jackets	Codes HeatMaster® 201
A01	Right side	21471415
A02	Left side	21471415
A03	Right side rear corner	21478415
A04	Left side rear corner	21473415
A05	Rear panel	21474415
A06	Right side front corner	21472415
A07	Left front side	21479415
A08	Upper front panel	2147A415
A09	Lower front panel	2147B415
A10	Burner cover	21476415
A11	Rear top cover	21475415
A12	Front top cover	21475416
A13	Rear half-base	2147S415
A14	Unequipped control panel	21477416
A15	Body + accessories (package No. 1)	27300047
No.	Accessories	
B01	Low-water-level pressure switch	557D3011
B02	Wilco circulator pump	557A4007
B03	3 bar / Ø 3/4" - 1" safety valve	557A1048
B04	Burner chamber insulating cover	51700041
B05	8-l expansion vessel	55301200
B06	Steam trap, Ø 1/2"	557A3001
B07	Drain cock, Ø 3/4"	557A1000
B08	Fill set, Ø 1/2"	55426018
B09	Type A, high-level turbulators	507F2009
B10	Type B, low-level turbulators	507F2010
No.	Setting and electrical accessories	
C01	MCBA	537D8016
C02	Transformer	547D3021
C03	NTC Duplo (NTC1 - NTC2)	5476G002
C04	NTC Single (NTC3)	5476G003
C05	Module AM3-11	10800080
C06	Module AM3-2	10800060
C07	Full control panel	24614133
C08	Display	537D3020
C09	Display case	537D3023
C10	Pressure gauge-thermometer	54441008
C11	ON/OFF switch	54766016
C12	Summer/Winter switch	54766017
C13	Control panel self-adhesive	617G0105
No.	Burner	
D01	Full burner	237D0118
D02	Fan	537D3034
D03	Venturi	537D4042
D04	110 x 3.5mm O-ring	557A0045
D05	Plate fan seal	557A0040
D06	Burner chamber plate seal	557A0020
D07	Ø 98mm burner tube + NIT	537DZ019
D08	Chamber plate sealing cord	51700025
D09	Ignition electrode	537DZ020
D10	Ignition cable	25760046
D11	Burner chamber plate insulating stone	51700040
D12	Burner chamber plate	2147P416
D13	Gas valve	537D4041
D14	Valve flange	537D8021

INSTALLATION DETAILS

Service date: _____	Flue gas T°: _____	Model: _____
% CO ₂ (min. load): _____	Efficiency: _____	Serial number: _____
% CO ₂ (max. load): _____	Gas pressure: _____	Heating system pressure setting: _____
<input type="radio"/> Gas _____		
<input type="radio"/> Propane _____	Name and signature: _____	

SERVICE NOTES

Service date: _____	Flue gas T°: _____	Comments: _____
% CO ₂ (min. load): _____	Efficiency: _____	_____
% CO ₂ (max. load): _____	Gas pressure: _____	_____
<input type="radio"/> Gas _____		
<input type="radio"/> Propane _____	Name and signature: _____	

Service date: _____	Flue gas T°: _____	Comments: _____
% CO ₂ (min. load): _____	Efficiency: _____	_____
% CO ₂ (max. load): _____	Gas pressure: _____	_____
<input type="radio"/> Gas _____		
<input type="radio"/> Propane _____	Name and signature: _____	

Service date: _____	Flue gas T°: _____	Comments: _____
% CO ₂ (min. load): _____	Efficiency: _____	_____
% CO ₂ (max. load): _____	Gas pressure: _____	_____
<input type="radio"/> Gas _____		
<input type="radio"/> Propane _____	Name and signature: _____	

Service date: _____	Flue gas T°: _____	Comments: _____
% CO ₂ (min. load): _____	Efficiency: _____	_____
% CO ₂ (max. load): _____	Gas pressure: _____	_____
<input type="radio"/> Gas _____		
<input type="radio"/> Propane _____	Name and signature: _____	

Service date: _____	Flue gas T°: _____	Comments: _____
% CO ₂ (min. load): _____	Efficiency: _____	_____
% CO ₂ (max. load): _____	Gas pressure: _____	_____
<input type="radio"/> Gas _____		
<input type="radio"/> Propane _____	Name and signature: _____	

SERVICE RECORD

Service date:	Flue gas T°:	Comments:
% CO ₂ (min. load):	Efficiency:	
% CO ₂ (max. load):	Gas pressure:	
<input type="radio"/> Gas		
<input type="radio"/> Propane	Name and signature:	

Service date:	Flue gas T°:	Comments:
% CO ₂ (min. load):	Efficiency:	
% CO ₂ (max. load):	Gas pressure:	
<input type="radio"/> Gas		
<input type="radio"/> Propane	Name and signature:	

Service date:	Flue gas T°:	Comments:
% CO ₂ (min. load):	Efficiency:	
% CO ₂ (max. load):	Gas pressure:	
<input type="radio"/> Gas		
<input type="radio"/> Propane	Name and signature:	

Service date:	Flue gas T°:	Comments:
% CO ₂ (min. load):	Efficiency:	
% CO ₂ (max. load):	Gas pressure:	
<input type="radio"/> Gas		
<input type="radio"/> Propane	Name and signature:	

Service date:	Flue gas T°:	Comments:
% CO ₂ (min. load):	Efficiency:	
% CO ₂ (max. load):	Gas pressure:	
<input type="radio"/> Gas		
<input type="radio"/> Propane	Name and signature:	

Service date:	Flue gas T°:	Comments:
% CO ₂ (min. load):	Efficiency:	
% CO ₂ (max. load):	Gas pressure:	
<input type="radio"/> Gas		
<input type="radio"/> Propane	Name and signature:	





excellence in hot water

www.acv-world.com

INTERNATIONAL

ACV international n.v
KERKPLEIN, 39
B-1601 RUISBROEK - BELGIUM
TEL.: +32 2 334 82 20
FAX: +32 2 378 16 49
E-MAIL: international.info@acv-world.com

BELGIUM

ACV BELGIUM nv/sa
KERKPLEIN, 39
B-1601 RUISBROEK-BELGIUM
TEL.: +32 2 334 82 40
FAX: +32 2 334 82 59
E-MAIL: belgium.info@acv-world.com

CHILE

ALBIN TROTTER Y ACV LTDA
SAN PABLO 3800
QUINTA NORMAL - SANTIAGO - CHILE
TEL.: +56 2 772 01 69
FAX: +56 2 772 92 62/63
E-MAIL: chile.info@acv-world.com

CZECH REPUBLIC

ACV CR SPOL. s.r.o
NA KRECKU 365
CR-109 04 PRAHA 10 - CZECH REPUBLIC
TEL.: +420 2 720 83 341
FAX: +420 2 720 83 343
E-MAIL: ceskarepublika.info@acv-world.com

DEUTSCHLAND

ACV WÄRMETECHNIK GMBH & CO KG
GEWERBEGBIET GARTENSTRASSE
D-08132 MÜLSEN OT ST. JACOB - DEUTSCHLAND
TEL.: +49 37601 311 30
FAX: +49 37601 311 31
E-MAIL: deutschland.info@acv-world.com

ESPAÑA

ACV ESPAÑA
C/DE LA TEIXIDORA, 76
POL. IND. LES HORTES
E-08302 MATARÓ - ESPAÑA
TEL.: +34 93 759 54 51
FAX: +34 93 759 34 98
E-MAIL: spain.info@acv-world.com

ARGENTINA

TECNO PRACTICA
ALFEREZ BOUCHARD 4857
1605 CARAPACHAY - BUENOS AIRES
TEL.: +54 11 47 65 33 35
FAX: +54 11 47 65 43 07
E-MAIL: jchas@tecnopractica.com

AUSTRALIA

HUNT HEATING PTY LTD
10 GARDEN BOULEVARD
3172 VICTORIA - AUSTRALIA
TEL.: +61 3 9558 7077
FAX: +61 3 9558 7027
E-MAIL: enquiries@huntheat.com.au

BRAZIL

SIMETAL INDUSTRIA E COMERCIO DE FERRAMENTAS LTDA
RUA GERSON ANDREIS 535
95112 - 130 CAXIAS DO SUL - BRAZIL
TEL.: +55 54 227 12 44
FAX: +55 54 227 12 26
E-MAIL: export@simetall.com.br

BULGARIA

PROXIMUS ENGINEERING LTD
7 BIAL KREM STR.
9010 VARNNA - BULGARIA
TEL.: +359 52 500 070
FAX: +359 52 301 131
E-MAIL: info@proximus-bg.com

CHINA

BEIJING HUADIAN HT POWER TECHNOLOGY DEVELOPMENT CO. LTD
ROOM B-912, TOWER B, COFCO PLAZA
N°. 8, JIANGUOMENNEI AVENUE
BEIJING 100005 - PEOPLE'S REPUBLIC OF CHINA
TEL.: +86 10 652 30 363/393 EXT 101
FAX: +86 10 652 27 071
E-MAIL: li.zheng@acv-world.com

SHANGHAI COOLTECH LTD

14/F E. CHINA MERCHANTS PLAZA
N°. 333 CHENGDU ROAD (N)
200041 SHANGHAI - CHINA
TEL.: +86 21 52 98 11 22 - 820
FAX: +86 21 52 98 13 58
E-MAIL: cooltech@cooltech.sh.cn

FRANCE

ACV FRANCE sa
31, RUE AMPERE - Z.I MI - PLAINE
F-69680 CHASSIEU - FRANCE
TEL.: +33 4 72 47 07 76
FAX: +33 4 72 47 08 72
E-MAIL: france.info@acv-world.com

ITALIA

ACV ITALIA
VIA PANA 92
I-48018 FAENZA (RA) - ITALIA
TEL.: +39 0546 64 61 44
FAX: +39 0546 64 61 50
E-MAIL: italia.info@acv-world.com

NEDERLAND

ACV NEDERLAND bv
POSTBUS 350
NL-2980 AJ RIDDERKERK - NEDERLAND
TEL.: +31 180 42 10 55
FAX: +31 180 41 58 02
E-MAIL: nederland.info@acv-world.com

POLAND

ACV POLSKA sp. z o.o.
UL. WITOSA 3
87 - 800 WŁOCŁAWEK - POLAND
TEL.: +48 54 412 56 00
FAX: +48 54 412 56 01
E-MAIL: polska.info@acv-world.com

PORTUGAL

BOILERNOX LDA
RUA OUTEIRO DO POMAR
CASAL DO CEGO, FRACÇÃO C,
PAVILHÃO 3 - MARRAZES
2400-402 LEIRIA - PORTUGAL
TEL.: +351 244 837 239/40
FAX: +351 244 823 758
E-MAIL: boilernox@mail.telepac.pt

RUSSIA

ACV RUSSIA
1/9, MAL'YI KISEL'NYI
103031 MOSCOW - RUSSIA
TEL.: +7 095 928 48 02 / +7 095 921 89 79
FAX: +7 095 928 08 77
E-MAIL: russia.info@acv-world.com

DENMARK

VARMEHUSET
FRICHSVEJ 40 A
8600 SILKEBORG - DENMARK
TEL.: +45 86 82 63 55
FAX: +45 86 82 65 03
E-MAIL: vh@varmehuset.dk

ESTONIA

TERMOMAX AS
TAHE 112A
51013 TARTU - ESTONIA
TEL.: +372 736 73 39
FAX: +372 736 73 44
E-MAIL: termomax@termomax.ee

GREECE

ESTIAS
MARASLI STREET 7
54248 THESSALONIKI - GREECE
TEL.: +30 23 10 31 98 77 / +30 23 10 32 03 58
FAX: +30 23 10 31 97 22
E-MAIL: info@genikithermanseon.gr

ÎLE MAURICE

SOTRATECH
29, RUE MELDRUM
BEAU BASSIN - ÎLE MAURICE
TEL.: +230 46 76 970
FAX: +230 46 76 971
E-MAIL: stech@intnet.mu

LITHUANIA

UAB "GILIUS IR KO"
SAVARNORIŲ PR. 192
3000 KAUNAS - LITHUANIA
TEL.: +370 37 308 930
FAX: +370 37 308 932

MAROC

CASATHERM
PLACE EL YASSIR
20300 CASABLANCA - MAROC
TEL.: +212 22 40 15 23
FAX: +212 22 40 04 86

SLOVAK REPUBLIC

ACV SLOVAKIA s.r.o.
PLUHOVÁ 49
831 04 BRATISLAVA - SLOVAK REPUBLIC
TEL.: +421 2 444 62 276
FAX: +421 2 444 62 275
E-MAIL: slovakia.info@acv-world.com

SLOVENIA

ACV D.O.O. SLOVENIA
OPEKARNA 22b
1420 TRBOVLJE - SLOVENIA
TEL.: +386 356 32 830
FAX: +386 356 32 831
E-MAIL: slovenia.info@acv-world.com

UK

ACV UK Ltd
ST. DAVID'S BUSINESS PARK
DALGETY BAY - FIFE - KY11 9PF
TEL.: +44 1383 82 01 00
FAX: +44 1383 82 01 80
E-MAIL: uk.info@acv-world.com

USA

TRIANGLE TUBE PHASE III
FREEWAY CENTER - 1 TRIANGLE LANE
BLACKWOOD NJ 08012 - USA
TEL.: +1 856 228 8881
FAX: +1 856 228 3584
E-MAIL: sales@triangletube.com

NEW ZEALAND

ENERGY PRODUCTS INTERNATIONAL
8/10 BELFAST PLACE
PO BOX 15058 HAMILTON - NEW ZEALAND
TEL.: +64 7 847 27 05
FAX: +64 7 847 42 22
E-MAIL: pmckenzie@tycoint.com

ÖSTERREICH

PROTHERM HEIZUNGSTECHNIK GmbH
TRAUNFURSTRASSE 113
4052 ANSELDEN - ÖSTERREICH
TEL.: +43 7229 804 82
FAX: +43 7229 804 92
E-MAIL: protherm@nextra.at

ROMANIA

SC TRUST EURO THERM SA
D.N PIATRA NEAMT - ROMAN
km 2 C.P 5 O.P 3 jud. Neamt
5600 PIATRA NEAMT - ROMANIA
TEL.: +40 233 20 62 06
FAX: +40 233 20 62 00
E-MAIL: office@eurotherm.ro

TUNISIE

SO.CO.ME CHAUMAX
BOÎTE POSTALE N°44
1002 TUNIS - TUNISIE
TEL.: +216 71 78 15 91
FAX: +216 71 78 87 31

UKRAINE

UKRTEPLOSERVICE LTD
PR. LAGUTENKO 14
83086 DONETSK - UKRAINE
TEL.: +38 062 382 60 47/48
FAX: +38 062 335 16 89