

HIGH LEVEL FLUE OUTLET KIT

LOGIC Combi

LOGIC + Combi

LOGIC Heat

LOGIC + Heat

LOGIC System

LOGIC + System

LOGIC Code Combi

i-mini

When replacing any part on this appliance, use only spare parts that you can be assured conform to the safety and performance specification that we require. Do not use reconditioned or copy parts that have not been clearly authorised by Ideal.

For the very latest copy of literature for specification and maintenance practices visit our website www.idealheating.com where you can download the relevant information in PDF format.

INTRODUCTION

This kit is suitable only for the domestic gas boilers listed below :

Logic Combi 24.....	G.C. No. 47-348-56	Logic + Heat 30	G.C. No. 47-750-22
Logic Combi 30.....	G.C. No. 47-348-57	Logic System 15.....	G.C. No. 41-750-24
Logic Combi 35.....	G.C. No. 47-348-58	Logic System 18.....	G.C. No. 41-750-25
Logic + Combi 24	G.C. No. 47-348-65	Logic System 24.....	G.C. No. 41-750-26
Logic + Combi 30	G.C. No. 47-348-66	Logic System 30.....	G.C. No. 41-750-27
Logic + Combi 35	G.C. No. 47-348-67	Logic + System 15.....	G.C. No. 41-750-29
Logic Heat 12	G.C. No. 47-399-99	Logic + System 18.....	G.C. No. 41-750-30
Logic Heat 15	G.C. No. 47-409-93	Logic + System 24.....	G.C. No. 41-750-31
Logic Heat 18	G.C. No. 47-409-94	Logic + System 30.....	G.C. No. 41-750-32
Logic Heat 24	G.C. No. 47-409-95	Logic Code Combi 26.....	G.C. No. 41-348-74
Logic Heat 30	G.C. No. 47-409-96	Logic Code Combi 33.....	G.C. No. 41-348-75
Logic + Heat 12	G.C. No. 47-409-97	Logic Code Combi 38.....	G.C. No. 41-348-76
Logic + Heat 15	G.C. No. 47-409-98	i-mini 24.....	G.C. No. 47-348-77
Logic + Heat 18	G.C. No. 47-409-99	i-mini 30.....	G.C. No. 47-348-78
Logic + Heat 24	G.C. No. 47-750-21		

These instructions must be read in conjunction with the Installation and Servicing Instructions supplied with the boiler.

This kit allows the boiler flue outlet to be externally extended vertically to ensure the flue product exit from the boiler is at a high level to overcome the problems associated with plume emission.

1 UNPACKING

Unpack the kit and check the contents.

- A. Cutting aid 60/100 - 1 off
- B. Boiler flue turret - 1 off
- C. 60/100 Flue tube c/w flue elbow/air terminal - 1 off
- D. 60mm Flue exit elbow - 1 off
- E. 60mm Horizontal flue exit - 1 off
- F. These Installation Instructions - 1 off

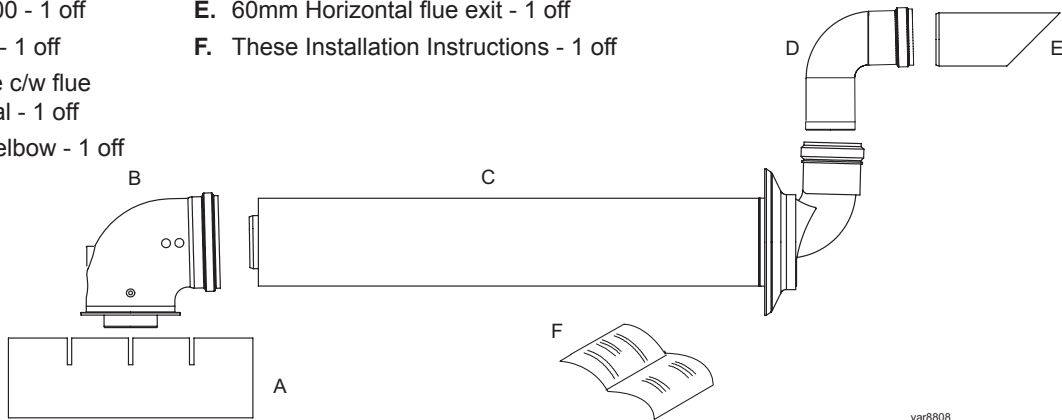

2 OPTIONAL EXTRAS (not provided with High Level Flue Outlet Kit)

- A. 60mm 90° Elbow kit (UIN 203229) - 1 off
- B. 60mm 45° Elbow kit (UIN 203230) - 2 off
- C. 60mm x 1M Flue outlet extension pipe (UIN 203228) - 1 off

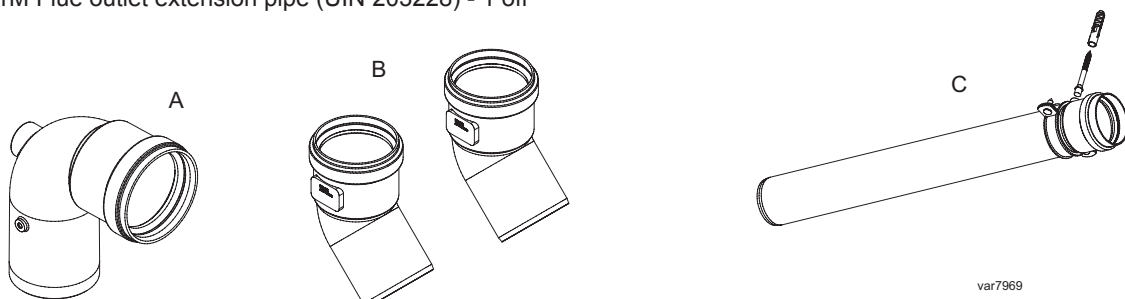

3 HIGH LEVEL FLUE OUTLET TERMINAL SITING

IMPORTANT.

For stated clearances for the flue outlet terminal in relation to openings, air inlet etc., refer to the Flue Installation section of the boiler Installation Instructions.

The minimum siting dimensions for the terminal positions, A, B, C stated can be applied when a high level flue outlet kit is fitted.

MINIMUM SITING DIMENSIONS FOR FANNED FLUE TERMINALS

Minimum Siting For Air Inlet

- A. Directly below an opening, air brick, opening windows etc. 150mm
- B. Directly above an opening, air brick, opening windows etc. 300mm
- C. Horizontally to an opening air brick, opening windows etc. 150mm

Minimum Siting For Flue Outlet

- A. Directly below an opening, air brick, opening windows (Horizontal Discharge). 300 mm
- B. Directly above an opening, air brick, opening windows (Horizontal Discharge). 300 mm
- C. Horizontally to an opening air brick, opening windows etc. 300 mm

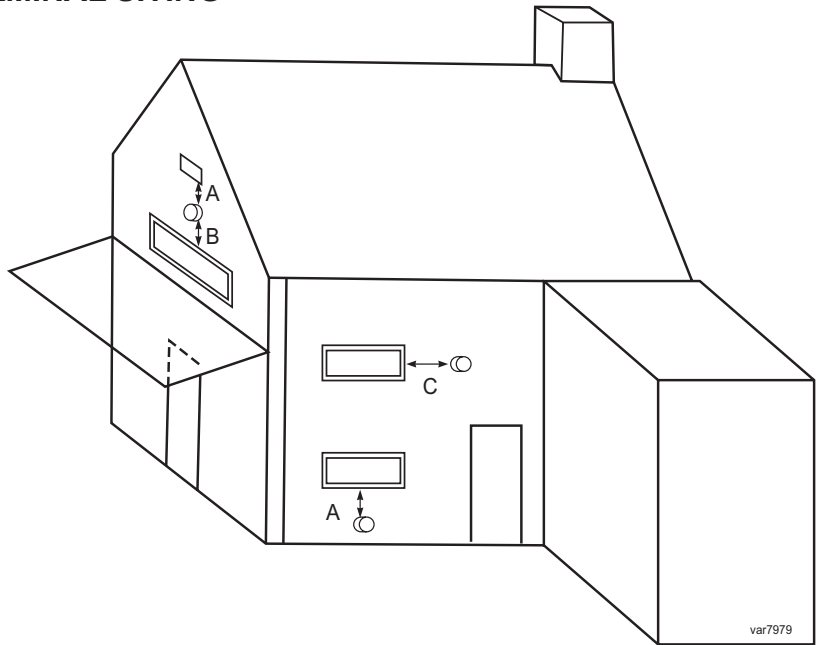

Note.

The flue outlet termination should not be installed less than 2 metres above ground level.

For further guidance on siting requirements please consult BS 5440-1 : Table C.1 and Fig C. 2.

4 FLUING OPTIONS

Refer to Frame 5 for detail of elbow resistance and maximum allowable flue length graph.

IMPORTANT NOTES

1. The air terminal must be mounted vertically to avoid rain ingress.
2. Flue pipe may be mounted horizontally or vertically providing the horizontal sections slope $1\frac{1}{2}^\circ$ back to the boiler.
3. The flue and air terminals MUST be separated by a minimum of 500mm.

Note: Only use water as a lubricant during assembly. Do not use mineral based oils.

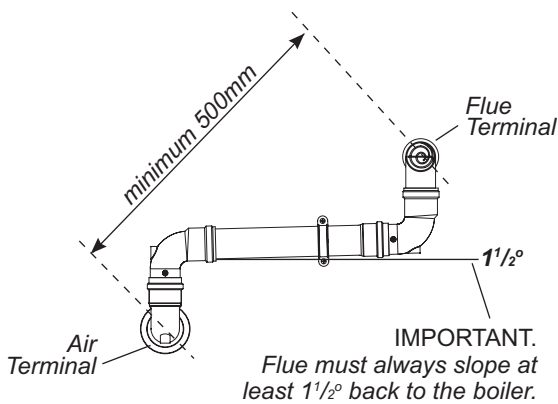
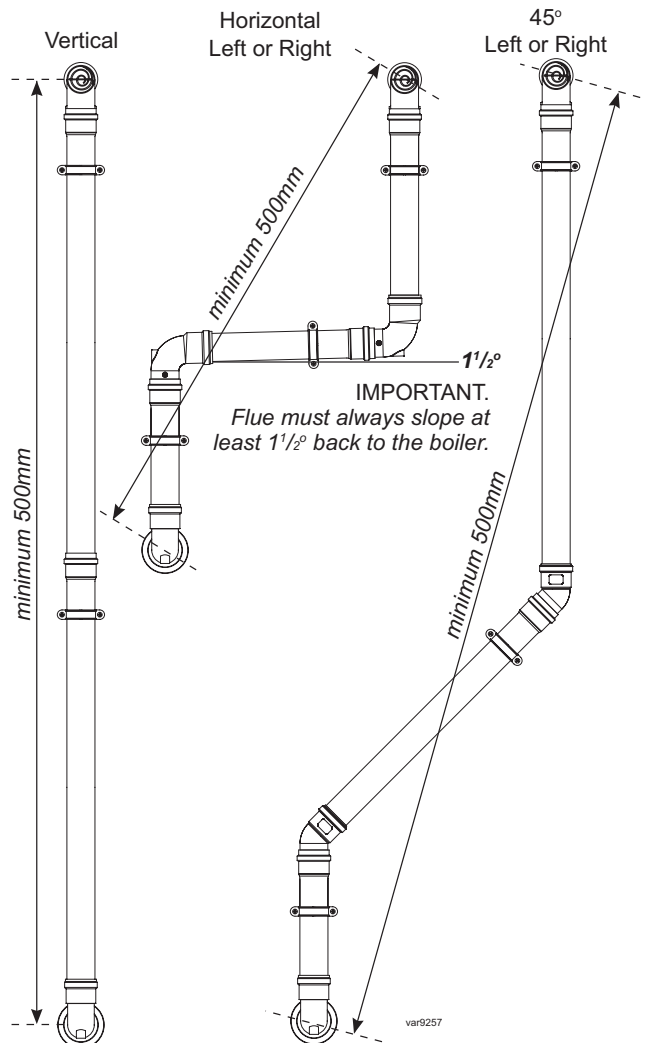

var9256

var9257

5 HIGH LEVEL FLUE OUTLET KIT FITTING

Refer to the boiler installation and servicing instructions for fitting of the boiler and its flue system.

Note.

The high level 60/100 flue tube is fitted in place of the Terminal Pack 'B'.

1. Follow the boiler installation instructions for boiler, turret and flue fitting but in place of the terminal pack 'B' use the 60/100 flue tube provided in the High Level Flue Outlet kit.

2. Using the graph below determine the external vertical flue extension allowed.

Note.

A 90° elbow (60mm dia) is equivalent to 1.4m of straight flue.

A 45° elbow (60mm dia) is equivalent to 1.25m of straight flue.

3. Push fit the required extension pipe(s) (UIN 203228), 90° elbows (UIN 203229) or 45° elbows (UIN 203230) to the height determined from the graph.

4. Fit the 90° flue exit elbow and the horizontal flue exit pipe.

5. Secure the extension pipe to the wall with the bracket provided.

6. A terminal guard is not required at the air inlet position.

Note. Flue length dimension B must be greater than 500mm.

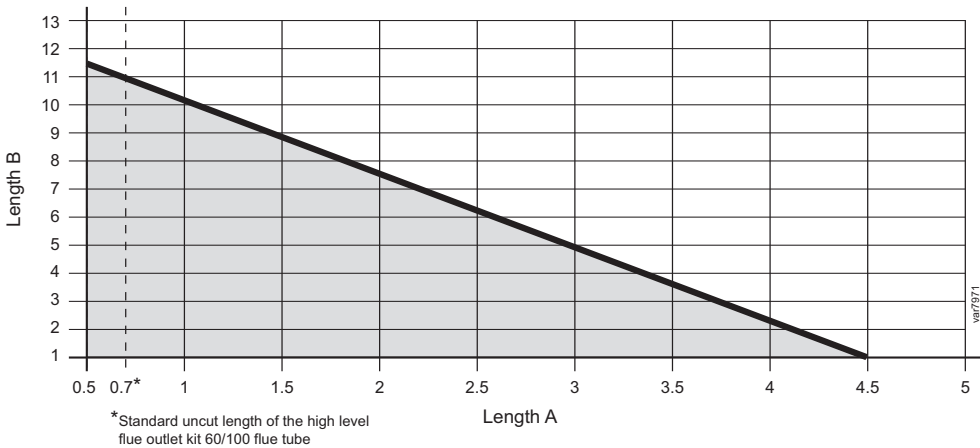
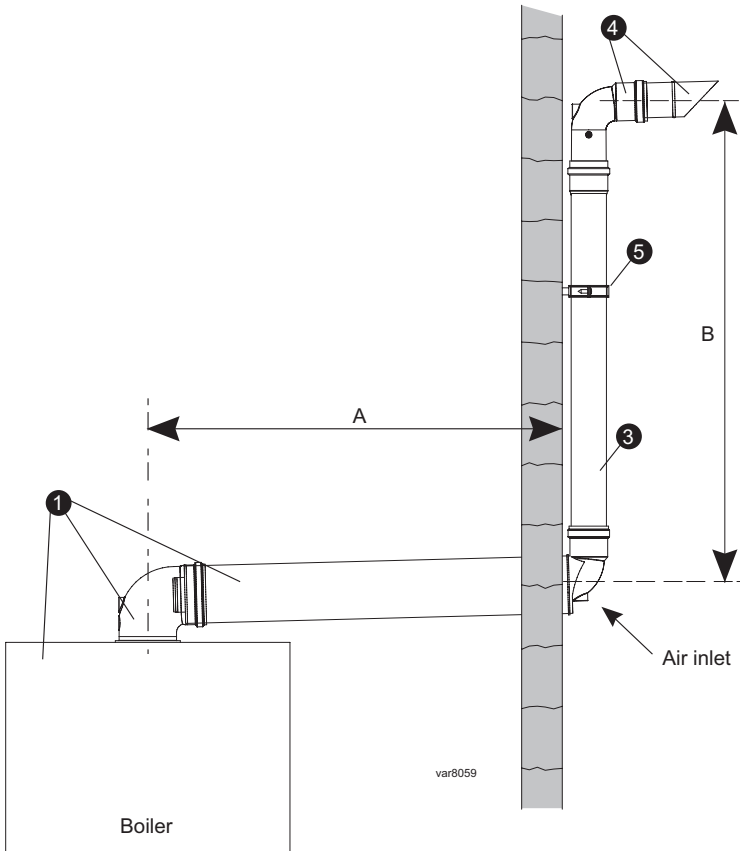

Note.

When using the high level flue outlet kit the horizontal (A) and vertical (B) lengths quoted in the graph replaces the flue length information contained in the boiler installation instructions.

Technical Training

The Ideal Technical Training Centre offers a series of first class training courses for domestic, commercial and industrial heating installers, engineers and system specifiers. For details of courses please ring:..... 01482 498 432

Ideal Boilers, P.O. Box 103, National Ave, Kingston upon Hull, HU5 4JN. Telephone: 01482 492 251 Fax: 01482 448 858. Registration No. London 322 137.

Ideal Stelrad Group pursues a policy of continuing improvement in the design and performance of its products. The right is therefore reserved to vary specification without notice.



Ideal Stelrad Group

Ideal Installer/Technical Helpline: 01482 445570

www.idealheating.com