



**CP715Si**  
*Electronic 2-Channel Common Timebase  
Programmer for Heating and Hot Water*

**For a large print version of these instructions  
please call Marketing on 0845 121 7400.**



Certification Mark

This product complies with the following EC Directives:  
Electro-Magnetic Compatibility Directive.  
(EMC) (2004/108/EC)  
Low Voltage Directive.  
(LVD) (2006/95/EC)

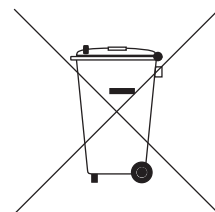

Danfoss can accept no responsibility for possible errors in catalogues, brochures, and other printed material. All trademarks in this material are property of the respective companies. Danfoss and the Danfoss logotype are trademarks of Danfoss A/S. All rights reserved.

# CP715Si

## Electronic 2-Channel Common Timebase Programmer for Heating and Hot Water

GB



## Index

---

<b>1.0 Installation Overview</b> .....	4
<b>2.0 Product Specification</b> .....	4
<b>3.0 Installation</b>	
3.1 Wiring.....	5
3.2 DIL Switch Settings .....	6
<b>4.0 Advanced Programming Options</b> .....	6
<b>5.0 Copy Functions Explained</b> .....	7
<b>6.0 Service Interval Timer</b> .....	9
<b>7.0 Wiring Conversions</b> .....	10-17

# 1.0 Installation Overview

---

## Please Note:

*This product should only be installed by a qualified electrician or competent heating installer and should be in accordance with the current edition of the IEEE wiring regulations.*

**GB**

# 2.0 Product Specification

---

Specification	230V model	24V model
Power supply	230 Vac, ±15%, 50/60 Hz	24 Vac, ±15%, 50/60 Hz
Switching action	2 x SPDT internally linked, Type 1B	
Unit switch rating	230 Vac, 3(1)A	24 Vac, 3(1)A
Battery back-up	24 hours minimum	
Programme resolution	± 1 minute	
Dimensions, mm (W, H, D)	135 x 88 x 32	
Design standard	EN 60730-2-7	
Control Pollution Situation	Degree 2	
Rated Impulse Voltage	2.5 kV	
Ball Pressure Test	75°C	

# 3.0 Installation

---

- Remove wallplate from unit by unscrewing the two screws on the bottom edge of the unit.
- From the top left hand corner of the wallplate, there must be clearances of at least 140 mm to the right, 15mm to the left, 30mm above and 100mm below in order to mount the plug-on module.

- The wallplate must be securely mounted either directly to the wall using suitable wood screws or to a flush mounted 1-gang electrical accessory box using M3.5 screws.
- Cable access can either be from behind for concealed cabling, or from below for surface cabling. If surface cable is used, cut out cable access slot on plug-on module prior to mounting.
- For wiring connections refer to diagram below.

CP715 Si models are double insulated and do not require an earth connection, however a parking terminal is provided on the wallplate. This is clearly marked with an Earth symbol.

- Prior to mounting the plug-on module, DIL switches on the rear of the plug-on module must be set. See diagram on page 6 for available options.
- Mount plug-on module to wallplate by locating tabs on top of wallplate in apertures on rear of module, hinge down and press firmly to wallplate before tightening securing screws on bottom of wallplate.

### 3.1 Wiring

For wiring conversion tables please see pages 10-17).

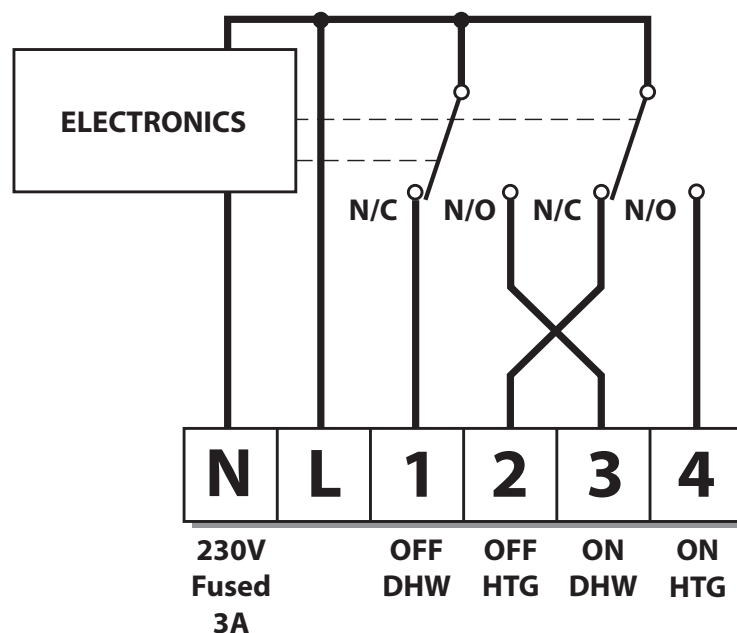

**Please Note:**

On 24 volt models power supply must be wired to A & B on wallplate.

**Please Note:**

***Always switch off mains first and never fit programmer to a live wallplate.***

## 3.2 DIL Switch Settings

Before mounting the unit, ensure the 4 DIL switches on the rear have been moved to the required settings.

GB

SW.1	3 ON/OFFs		2 ON/OFFs
SW.2	GRAVITY		PUMPED
SW.3	5/2 DAY		7 DAY or 24 HOUR
SW.4	7 DAY		24 HOUR

Tick the INSTALLER SETTING box on the inside flap label to notify user in which mode their unit is set (24hr, 5/2 day or 7 day).

INSTALLER SETTING	
24 Hour	<input type="checkbox"/>
5+2 Day	<input type="checkbox"/>
7 Day	<input type="checkbox"/>

## 4.0 Advanced Programming Options

To enter advanced programming press **PROG**, **+** and **DAY/HOL** together and hold for 5 seconds.

### Option 1 - (3 or 2 On/Offs per day)

Use **+** or **-** to change between 3 or 2 on/off each day.

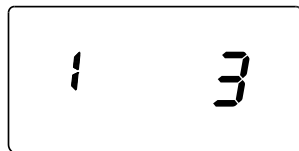

3 on/off each day (Factory setting)

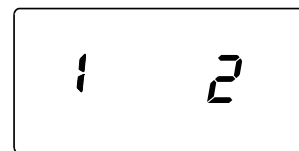

2 on/off each day

### Option 2 - (Disable or enable auto time change)

Press **NEXT**, then use **+** or **-** to change between auto time change enabled to auto time change disabled.

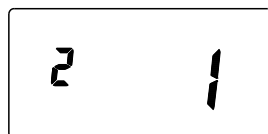

Auto time change enabled (Factory setting)



Auto time change disabled

### **Option 8 - (Advanced Copy Functions)**

Press **NEXT**, then + or - to change between the following copy options:

(0) Standard copy in 7 day and 5+2 day.

(1) Enhanced copy in 7 day and 5+2 day.

(2) Enhanced copy in 7 day and AB copy in 5+2 day.

For an explanation of the copy features and how to use them please see below.

Press **PROG** to return to **RUN**.

## **5.0 Copy Functions Explained**

---

There are 3 possible copy functions available. These are; **Standard Copy**, **Enhanced Copy**, and **AB copy**. Copy functions are enabled/disabled in the Advanced Programming Options (page 6).

**Standard Copy:** Pressing copy will copy the previous days events into the displayed day. The unit will then display the 1st event for the new day. This copy function is present only if the unit is set to run in **5+2 or 7 day mode**.

**Enhanced Copy:** The enhanced copy function is available in **7 day mode only**. This allows any day to be copied to any other day, or days. To use the enhanced copy function go into the event programming using the **PROG** button, then:

1. Use the **DAY** button to find the day to be copied from.
2. Press the **COPY** button to select the day to be copied from. When selected, the day should begin to flash.
3. Use the **DAY** button to find the day to be copied to.
4. Press **COPY** button to copy the selected day.
5. Repeat steps 3 and 4 to select and copy other days.
6. To stop copying, use the **DAY** button to go back to the flashing day and press the **COPY** button. The previously flashing day will stop flashing to indicate it has been de-selected.

**NOTE:** When a day has been copied to, it will remain visible and not flashing when the **DAY** button is used to select other days.

**AB Copy:** The AB copy function is available in **5+2 mode only** and only if activated in the Advanced Programming setting.

A and B days, when selected, can be any group of days e.g. 5+2, 4+3 etc. The days do not have to run in sequence. For example, to operate in a 5+2 day mode the days can be set as follows:

**GB**

A Days	B Days
Mon Tues Thurs Fri Sat	Wed Sun

To use the AB copy function – press the **PROG** button:

1. This will show the “A” days, with all the days selected.
2. Use the **DAY** button to highlight a day.
3. Subsequent presses of the **DAY** button will increment through the days.
4. Press the + button to select a specific day as an “A” day, or press the – button to specify a day as a “B” day.
5. Once the day has been selected as an “A” or “B” day the programme will automatically jump to the next day.
6. When the last day of the week is active, pressing +, -, or **DAY** will move back to the “A” days displayed with no selected (flashing) days (see image below).
7. Repeat 2 to 6 until all selections have been made.
8. When selections are completed, press the **PROG** button to move to event programming.

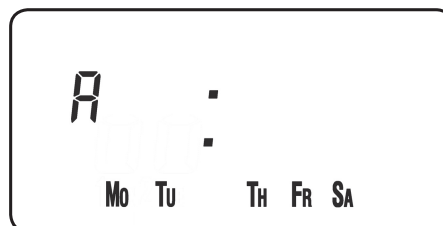

### **Event Programming in AB mode**

1. Programme “A” day events using the + (time advance), - (time decrease), and **NEXT** (next period) buttons.
2. Press the **DAY** button to change to programme the “B” days.
3. Programme “B” day events using the + (time advance), - (time decrease), and **NEXT** (next period) buttons.



## 6.0 Service Interval Timer

---

The CP715 Si is fitted with an installer setback service interval timer. If this feature is required please contact our technical department. Setting instructions for this gas safety feature are only available to bona fide heating installers.

















**GB**

## 7.0 Wiring Conversions

*(Applies only to 230 volt models)*

Wiring conversions can be used when replacing the following programmers with the CP715 Si. Some time controls are connected differently depending on the type of system they are controlling. Consult the column headed "NOTE This conversion ..." to determine whether **Table A (pages 10-13)** or **Table B (pages 14-17)** should

**GB**













<b>Table A</b>  <b>DANFOSS RANDALL FP715, CP715 (PUMPED)</b>	<b>MAINS</b>			<b>DHW OFF</b>	<b>HTG OFF</b>	<b>DHW ON</b>
		<b>N</b>	<b>L</b>	<b>1</b>	<b>2</b>	<b>3</b>
DANFOSS RANDALL 922/972		N	L	1	4	3
DANFOSS RANDALL 4033		7	6	5	3	4
DANFOSS RANDALL SET 5		N	L	3	6	1
HORSTMANN 423, AMETHYST 7 & 10		2,3	1	4	6	5
HORSTMANN 424 GEM		2,3	1,10	6	9	4
HORSTMANN LEUCITE 423 & 424		2	1	4	8	<b>3</b>
HORSTMANN 425 DIADEM		N	L	3	6	1
HORSTMANN 525 & 527		N	L	3	6	1
HONEYWELL ST669		N	L	7	4	6
HONEYWELL ST6300 & ST6400		N	L	1	2	3
PEGLER SUNVIC SP50/SP100		N	L	1	4	2
POTTERTON EP2000, EP3000		N	L	1	2	3
RANDALL TSR3+3		3,6	7	2	5	1
RANDALL 3033		1,7	6	5	3	4
RANDALL 702		N	L	4	2	3
SANGAMO FORM 1 410 & 414		4,5	6	2	7	1
SANGAMO S409/1		N,1,3	L	-	-	2

be used. If in any doubt, contact our Technical Services Department before proceeding with the replacement.



















\*Any wires connected to switch COMMONS which are linked LIVE on existing wallplates must be transferred to the LIVE terminal on the new wallplate.



















	HTG ON	Wires other than links in these terms go to LIVE		NOTE This conversion applies only if....	An additional terminal block may be required where these disconnected leads (or pairs) should be terminated			
		L	L		A	B	C	D
	4	L	L					
	6	2	5	Programmed selectors UNLINKED				
	2	1	-					
	4	2	5					
	7	-	-		8			
	7	5	8	Terminals 5,8 & 10 are LINKED				
	6	5	7	Terminals 5 & 7 are LINKED				
	4	2	5	Programme selectors UNLINKED				
	4	2	5	Programme selectors UNLINKED				
	3	8	5					
	4	-	-					
	5	3	-		S	S		
	4	-	5	Programme selectors UNLINKED	A	B	C	D
	4	-	-					
	2	-	-					
	1	6	5					
	8	3	-					
	5	-	-					

<b>Table A continued</b>  <b>DANFOSS RANDALL</b> <b>FP715, CP715</b> <b>(PUMPED)</b>	<b>MAINS</b>			<b>DHW</b> <b>OFF</b>	<b>HTG</b> <b>OFF</b>	<b>DHW</b> <b>ON</b>
		<b>N</b>	<b>L</b>	<b>1</b>	<b>2</b>	<b>3</b>
SANGAMO S409/3		3,6	7	4	2	5
SATCHWELL LIBRA & DHP 2201		1	2	8	5	6
SATCHWELL ET 1401 & 1451		1	2	8	5	7
SMITHS IND. CENTROLLER 90		1	2	-	-	5
SMITHS IND. CENTROLLER 1000		N	L	1	2	3
SWITCHMASTER 800 & 805		N	L	4	2	3
SWITCHMASTER 900 & 9000		N	L	4	2	3
SWITCHMASTER SONATA		N	L	3	6	1
VENNER CHC/W2 (WITH STAT)		N,2,4	L	-	-	<b>1</b>
VENNER CHC/W2 (AIR STAT LINKED)		N,2,4	L	-	-	1
VENNER VENOTROL 80M & 80PM (WITH AIR STAT)		N,3	L	1	4	2
VENNER VENOTROL 80M & 80PM (AIR STAT LINKED)		N,3	L	1	4	2

	HTG ON	Wires other than links in these terms go to LIVE		NOTE This conversion applies only if....	An additional terminal block may be required where these disconnected leads (or pairs) should be terminated			
		L	L		A	B	C	D
	4	L	L					
	1	-	-					
	3	7	4					
	4	6	3					
	4	-	-		3	6		
	4	-	-	Programme selectors UNLINKED				
	1	-	-					
	1	-	-	Programme selectors UNLINKED	A	B	C	
	4	-	-					
	A/S	-	-	Used in a system having independent control of water and heating	A/S 3			
	3	-	-					
	A/S	-	-		A/S 5			
	5	-	-					

<b>Table B</b>  <b>DANFOSS RANDALL FP715, CP715 (PUMPED)</b>	<b>MAINS</b>			<b>DHW OFF</b>	<b>HTG OFF</b>	<b>DHW ON</b>
		<b>N</b>	<b>L</b>	<b>1</b>	<b>2</b>	<b>3</b>
DANFOSS RANDALL 922/972		N	L	1	4	3
DANFOSS RANDALL 102/102E/102E7		5	3,6	-	-	1
HORSTMANN 423 DIAMOND POTTERTON 423		N	L,1,3	-	-	2
HORSTMANN 424 DIAMOND		N	L,1,3	-	-	2
HORSTMANN CORAL 423 & 424		2,3	1	-	-	<b>BOILE (8)</b>
HORSTMANN 425 DIADEM		N	L	3	6	1
HORSTMANN 525 & 527		N	L	3	6	1
HONEYWELL ST669		N	L	-	-	8
POTTERTON EP2000, EP3000		N	L	1	2	3
RANDALL TSR2P		3	1,2	-	-	5,6
RANDALL MKII R6		3	1,2	-	-	4
DANFOSS RANDALL 3060 & 3020P		1,7	6	-	-	4
RANDALL 701		N	L	4	2	3
DANFOSS RANDALL SET 2		N	L	3	6	1,5
SANGAMO M5 410 FORM 4		4,5	3	2	7	1,6
SANGAMO S409 FORMS 1 & 4		N,1,3	L	-	-	2
SANGAMO (EARLY MODEL) S410 FORM 4		N,2	L	-	-	1,3
SATCHWELL LIBRA		1	2	8	5	6

/	HTG ON	Wires other than links in these terms to LIVE		NOTE This conversion applies only if....	An additional terminal block may be required where these disconnected leads (or pairs) should be terminated			
		L	L		A	B	C	D
	4	L	L		A	B	C	D
	6	2	5	Programmed selectors UNLINKED				
	2	-	-					
	4	-	-		5	6		
	4	-	-		5			
IR	AIR STAT (8)	-	-		4,7	5	6	
	4	2	5	Programme selectors UNLINKED				
	4	2	5	Programme selectors UNLINKED				
	7,3	6	5	...set for gravity HW				
	4	-	5	Programme selectors UNLINKED	A	B	C	D
	7	-	-	1 & 2 are LINKED 5 & 6 are LINKED	4			
	5	-	-		6	7		
	2	-	-		3	5		
	1	6	5					
	4	2	-	With Links L-2 & 1-5				
	8	-	-	1 & 6 are LINKED				
	5	-	-		6,4			
	4	-	-	1 & 3 are LINKED				
	3	7	4					

Table B cont...  <b>DANFOSS RANDALL FP715, CP715 (PUMPED)</b>	MAINS			DHW OFF	HTG OFF	DHW ON
		N	L	1	2	3
SMITHS IND. CENTROLLER 1000		N	L	-	-	3
SMITHS IND. CENTROLLER 60		1	2	-	-	5
SMITHS IND. CENTROLLER 10		N	L	-	-	3
SMITHS IND. CENTROLLER 70		1	2	-	-	5
SMITHS IND. CENTROLLER 1000		N	L	1	2	3
SWITCHMASTER 320 & 350		N	4,L	-	-	3
SWITCHMASTER 400		N	L	-	4	3
SWITCHMASTER 600		N	L	-	-	3
SWITCHMASTER 900 & 9000		N	L	4	2	3
VENNER VENTROL		N,A,M	L,L,1	-	-	V
VENNER VENOTROL 80 (AIR STAT)		N,1, 3,4	L	-	-	2
VENNER VENOTROL 80 (AIR STAT LINKED)		N,1 3,4	L	-	-	2
VENNER CHC/W2 (WITH STAT)		N,2,4	L	-	-	1
VENNER CHC/W2 (AIR STAT LINKED)		N,2,4	L	-	-	1
VENNER VENOTROL 80P (WITH AIR STAT)		N,1,3	L	-	4	2
VENNER VENETROL 80P (AIR STAT LINKED)		N,1,3	L	-	4	2



M I	HTG ON	Wires other than links in these terms to LIVE		NOTE This conversion applies only if....	An additional terminal block may be required where these discon- nected leads (or pairs) should be terminated			
		L	L		A	B	C	D
	4	L	L		A	B	C	D
	2	-	-		1	4		
	4	-	-		3			
	2	-	-		1,4			
	4	-	-		3	6		
	4	-	-	Programme selectors UNLINKED				
	1	-	-	L & 4 are LINKED	2			
	1	-	-		2			
	1	-	-		2	4		
	1	-	-	Programme selectors UNLINKED	A	B	C	
	S,F	-	-		T,P	O		
	A/S	-	-		A/S 5			
	5	-	-					
	A/S	-	-	Used in a system having control of WATER ONLY or WATER & HEATING TOGETHER	A/S 3			
	3	-	-					
	A/S	-	-		A/S 5			
	5	-	-		6,4			

**GB**





**Danfoss Randall Ltd.**

Ampthill Road  
Bedford MK42 9ER

Tel: 0845 1217 400

Fax: 0845 1217 515

Email: [danfosrandall@danfoss.com](mailto:danfosrandall@danfoss.com)

Website: [www.danfoss-randall.co.uk](http://www.danfoss-randall.co.uk)