

# 102E7

*7-day electronic  
mini-programmer for  
controlling hot water  
and heating*

## Installation & User Instructions

including Factory Replacement Units (FRU)



This product complies with the following EC Directives:

**Electro-Magnetic Compatibility Directive.**

(EMC) (2004/108/EC)

**Low Voltage Directive.**

(LVD) (2006/95/EC)



The Danfoss logo, featuring the brand name in a stylized, cursive script.

# Index

## Installation

---

Product specification	3
Installation	4-6
Wiring	6-9
Replacement	10-11

## User

---

Your programmer	12
Resetting the unit	12
24hr or AM/PM display	13
Setting the Time and Day	13
Factory preset programmes	14
Changing the preset programmes	15
Setting the programme - 7 day	16-17
Setting the programme - 5/2 day	18-19
Running your programme	20
Temporary user overrides	21
Battery backup	22
Contact details	24

# Installation Instructions

## Please Note:

*This product should only be installed by a qualified electrician or competent heating installer, and should be in accordance with the current edition of the IEEE wiring regulations.*

## Product specification

Specification	
Power supply	230 Vac $\pm$ 15%, 50 Hz
Switching action	1 x SPST, Type 1B
Max. Switch rating	264Vac, 50/60Hz, 3(1)A
Running/Setting Accuracy	$\pm$ 1 min./month
Power Reserve	Minimum 24 hours
Max. Ambient Temperature	45°C
Dimensions, mm (W, H, D)	102 x 136 x 47
Design standard	EN 60730-2-7
Control Pollution Situation	Degree 2
Rated Impulse Voltage	2.5kV
Ball Pressure Test	75°C

Specification

# Installation

---

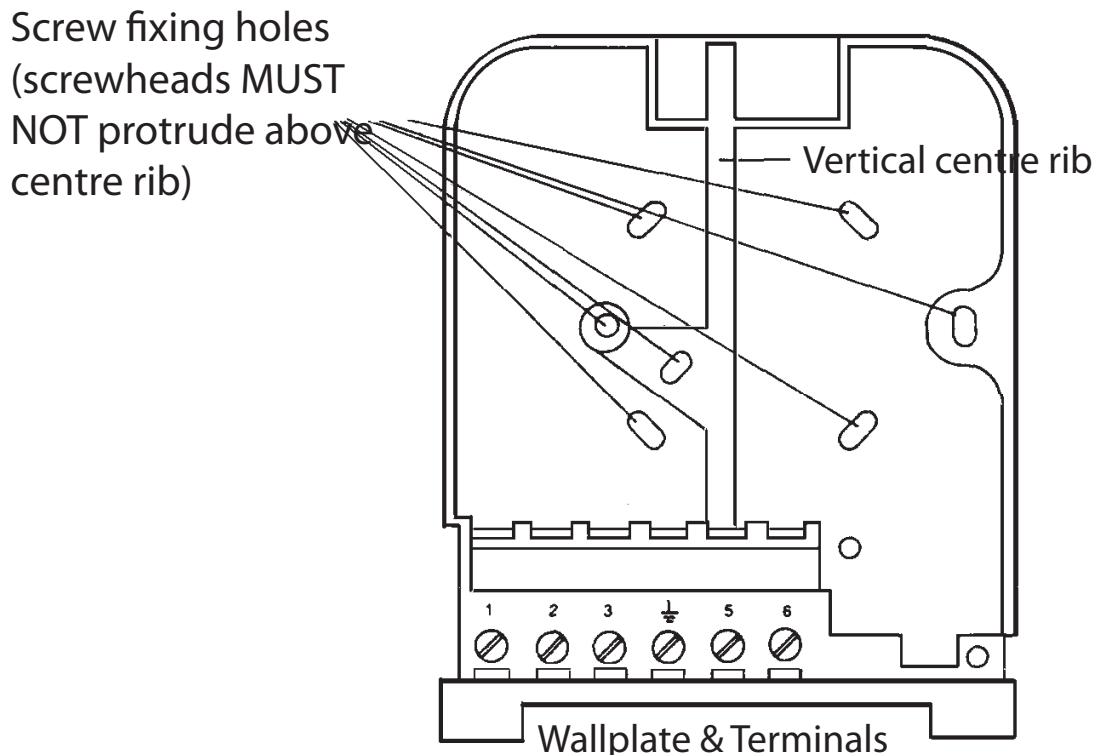

**NB. For FRU units - go straight to point 6 below.**

1. Loosen the fixing screw in the base of the unit to release the Wiring Cover.
2. Holding the unit face downwards, press firmly in the centre of the wallplate and slide it apart and lift it from the module.
3. Fix the wallplate and terminal block to the wall, or plaster box, as required. Ensure that the screw heads do not protrude beyond the vertical centre rib of the wallplate, or this will prevent the module correctly locating onto the wallplate.



4. Surface cables can only enter from below the unit. Cut an appropriate cable aperture in the wiring cover. If the wallplate is mounted on a plaster box, cables can enter from the rear below the terminal block.

5. Electrical connections are simplified by using a Wiring Centre. However, if this is not used, the wallplate terminal identification is as shown.

Water	Heating	COM	Mains Supply (via 3 amp fuse)		
ON	ON			N	L
1	2	3		5	6

If the system being controlled is 230Vac then terminals 3 and L must be linked with insulated cable capable of carrying full load current. Whilst the unit does not require an earth connection, a terminal is provided on the wallplate for earth continuity purposes.

6. Referring to the wiring diagrams on page 6-9, connect the unit as shown.
7. Find out from the user whether the unit is required to operate in **7-day mode (factory preset)** or **weekday/ weekend mode (5/2 day)**. To convert to 5/2 day mode remove the small two-way connector from the pins towards the left of the recess on the rear of the module, then press the button marked **R/S** under the flap to RESET the unit.
8. Ensure all dust and debris are cleared from the area. Plug the module into the wallplate by locating it onto the wallplate and, when flush with it, sliding it down, ensure the hook at the top of the wallplate engages with the slot at the back of the module.
9. Before setting the programme, check the unit and circuit. Set the rocker switch to **WATER & HEATING**. Press the **SELECT** button until the bar in the display lines up with the word **ON**. Adjust the remote thermostats to check the system operates correctly.

10. Then press the **SELECT** button until the bar lines up with the word **OFF** and check the system does not operate.
11. Set the rocker switch to **WATER ONLY**. Press the **SELECT** button until the bar in the display lines up with the word **ON** and check that the water circuit only operates.
12. When the circuit check has been completed, replace the wiring cover and tighten the fixing screw. Cut any cable aperture in the wiring cover which may be necessary to accommodate surface mounted cables.
13. Finally set time of day and programmes required, noting that the unit is supplied with a pre-set programme, as stated on Page 14.

## Wiring

---

Wiring

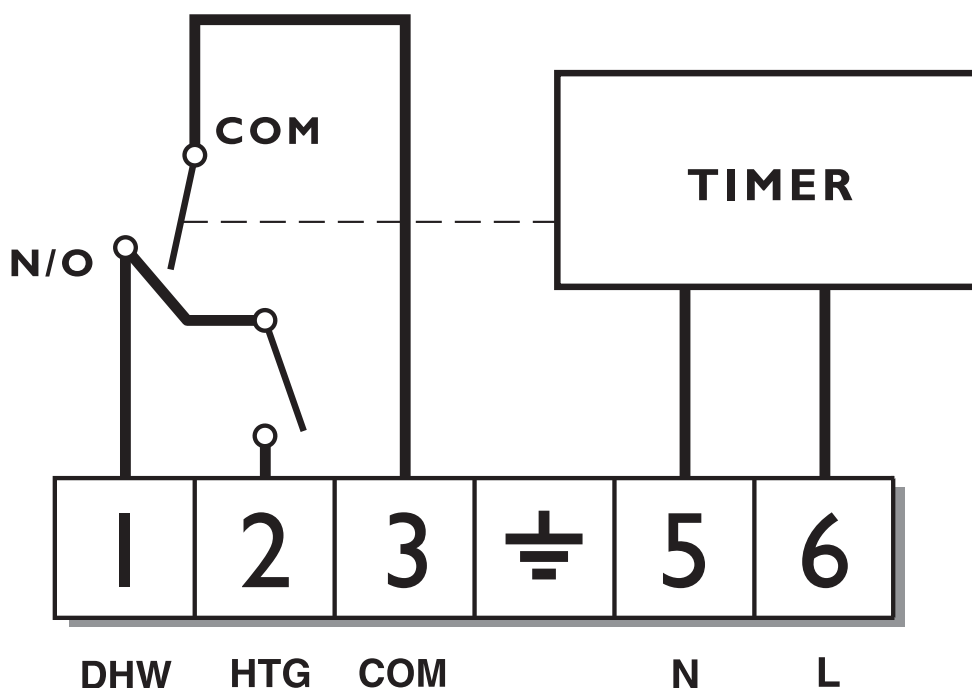

102, 102E5, 102E7

# Typical Gravity DHW with Pumped Heating

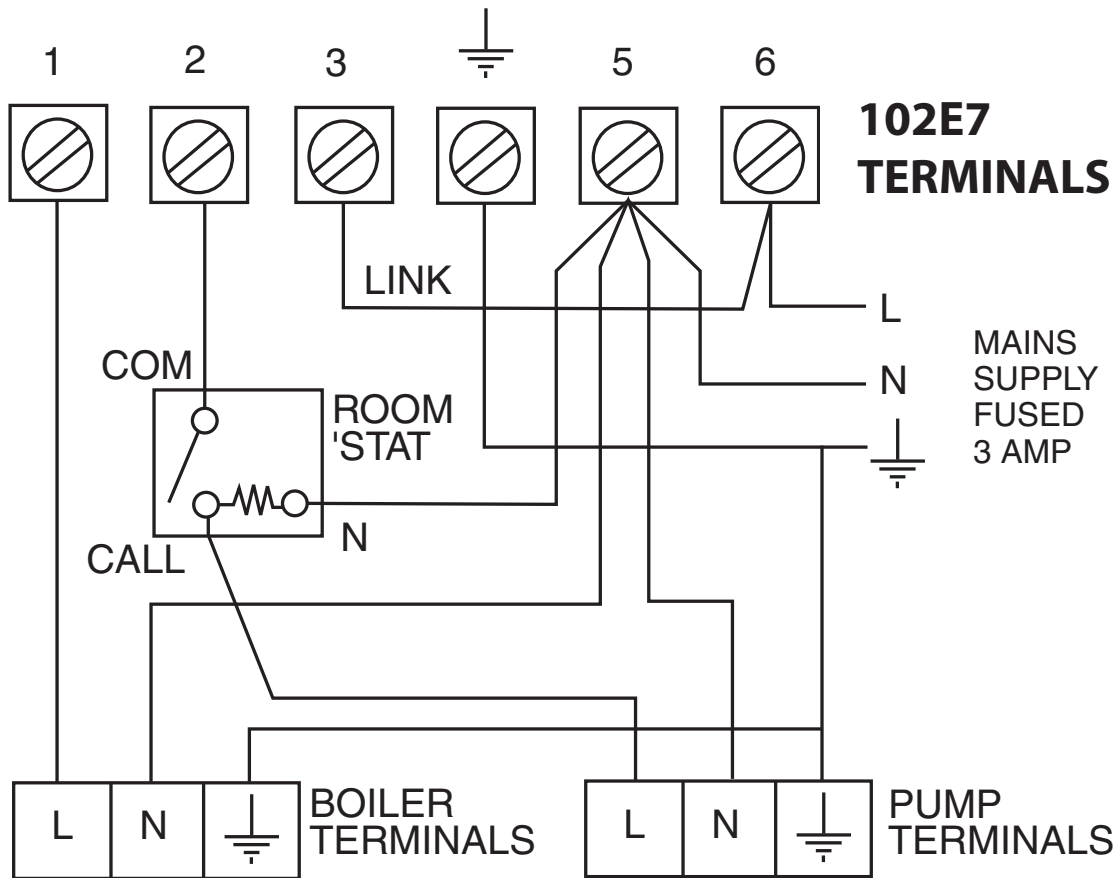

Typical domestic gas or oil-fired central heating system with gravity hot water and pumped heating. (If a room thermostat is not used, wire pump live directly to terminal 2 of the 102E7).

# Typical Heating and Hot Water control system using 3-port mid-position valve

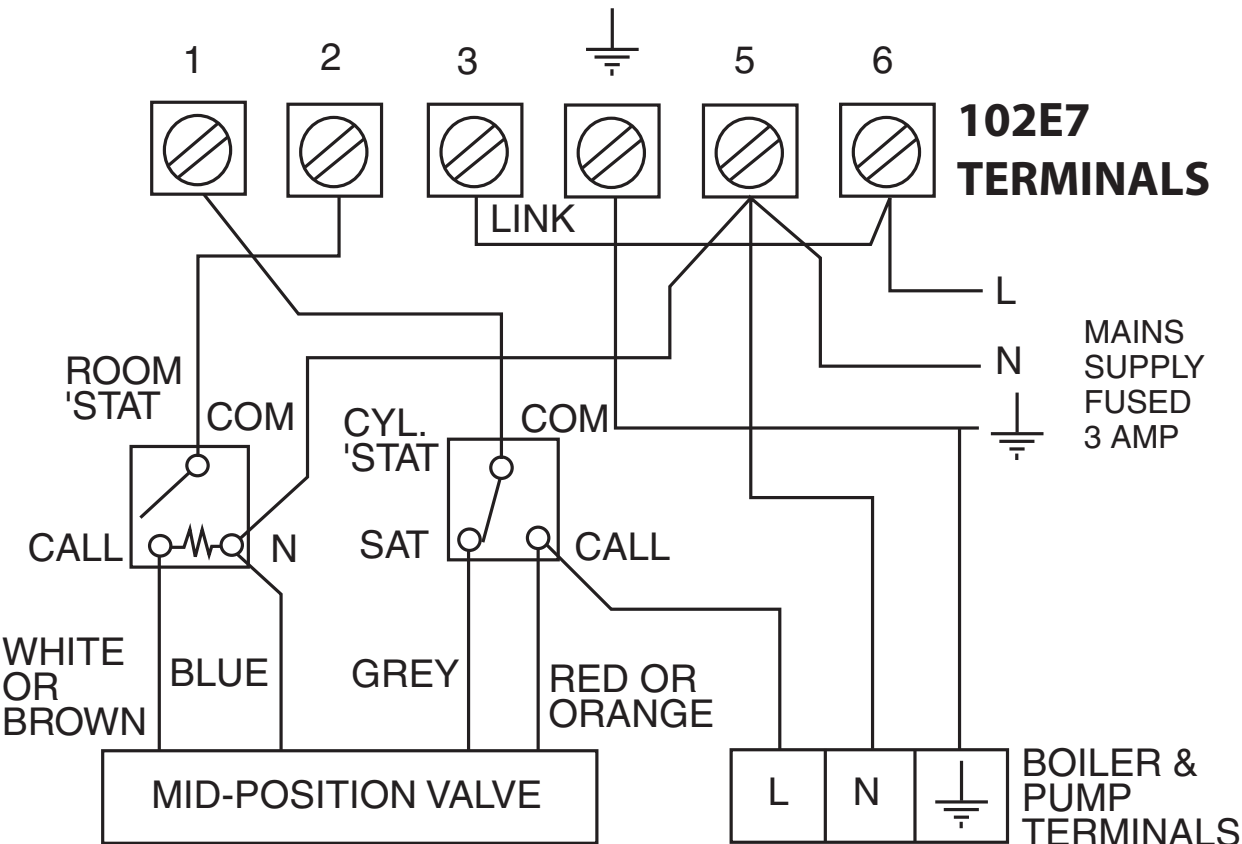

**Wiring**

The above control system is available as the Danfoss Randall 102E7 HEATSHARE pack, which also includes the RMT room thermostat, AT cylinder thermostat, HS3 mid-position valve and a WB12 wiring box.





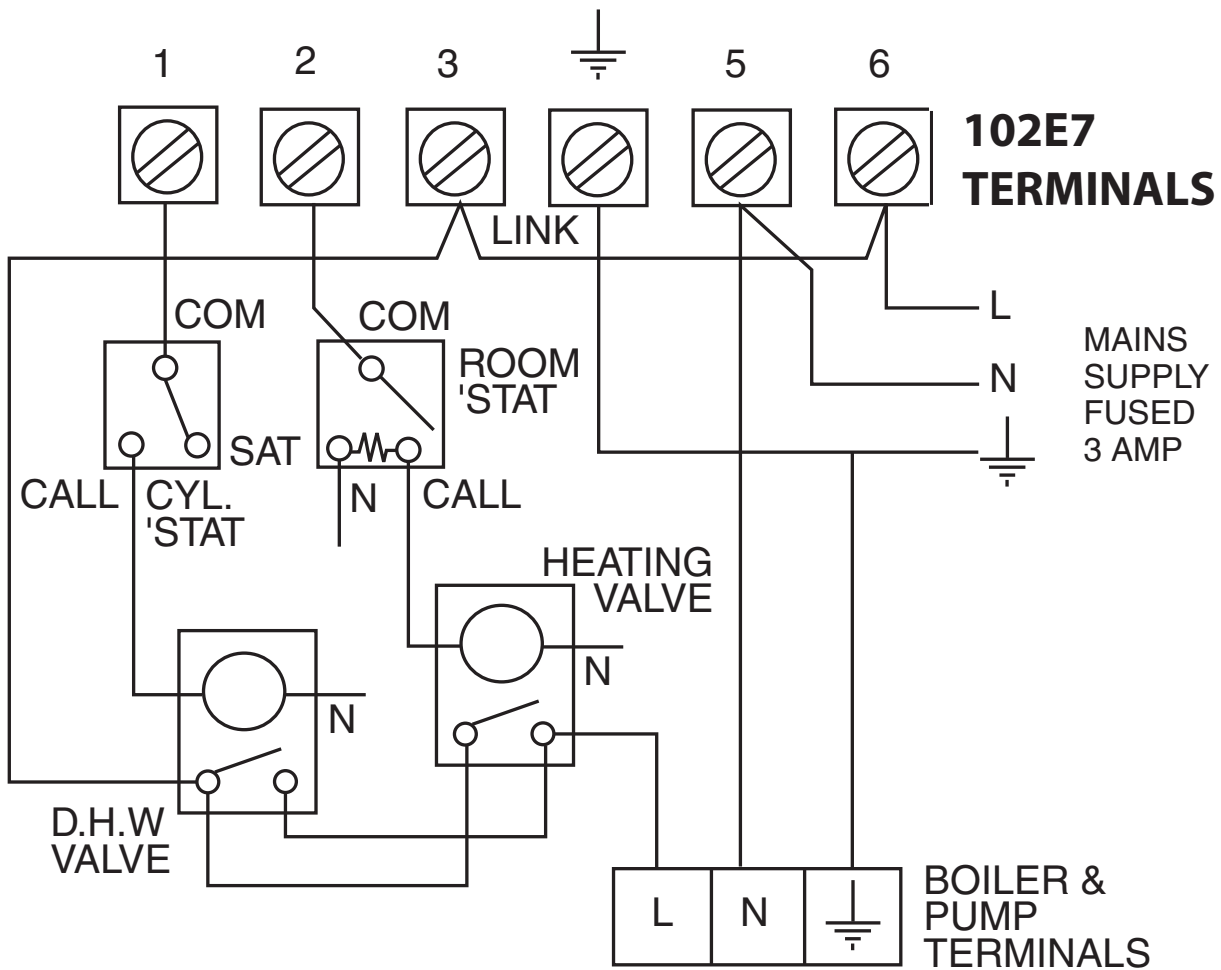







# Typical Heating and Hot Water control system using 2-port zone valves



The above control system is available as the Danfoss Randall 102E7 HEATPLAN pack, which also includes the RMT room thermostat, AT cylinder thermostat, two 22mm HPP zone valves and a WB12 wiring box.

# Replacement

DANFOSS RANDALL 102E7	Water ON	Heating ON	COM	MAINS SUPPLY (via 3 amp fuse)			An additional terminal block is required where these disconnected leads (or pairs of leads) should be terminated		
					5 (N)	6 (L)	A	B	C
	1	2	3		5 (N)	6 (L)	A	B	C
RANDALL 102, 102E, 102E7	1	2	3		5	6			
RANDALL 3020P, 3060	4	2	-		1,7	6	3	5	
RANDALL MKII R6	4	5	-		3	1,2	6	7	
HORSTMANN CORAL 423 & 424	Boiler (8)	Air'Stat (8)	-		2,3	1	4,7	5	6
HORSTMANN DIAMOND 423	2	4	-		N	L,1,3	5	6	
HORSTMANN DIAMOND 424	2	4	-		N	L,1,3	5		6
POTTERTON 423	2	4	-		N	L,1,3	5	6	
SANGAMO S409 F1 & F4	2	5	-		N,1,3	L	4,6		
SANGAMO (Early model) S410 Form 4	1,3	4	-		N,2	L			
CAMTEC INC									

SMITHS IND. CENTROLLER 100	3	2	-	⊥	N	L	1	4
SMITHS IND. CENTROLLER 60	5	4	-	⊥	1	2	3	
SMITHS IND. CENTROLLER 10	3	2	-	⊥	N	L	1,4	
SMITHS IND. CENTROLLER 70	5	4	-	⊥	1	2	3	6
SWITCHMASTER 320, 350	3	1	-	⊥	N	4,L	2	
SWITCHMASTER 600	3	1	-	⊥	N	L	2	4
VENNER VENOTROL	V	S,F	-	⊥	N,A,M	L,L1	T,P	0
VENNER VENOTROL 80 (Air'Stat)	2	A/S	-	⊥	N,1,3	L	A/S,5	
VENNER VENOTROL 80 (Air'Stat Linked)	2	5	-	⊥	N,1,3	L		

# User Instructions

## Your programmer

---

Your 102E7 mini-programmer allows you to switch your heating and hot water on and off at times that suit you.

The 102E7 can provide 3 ON periods and 3 OFF periods each day and can offer either 7-day control (a different programme for each day of the week) or 5/2 day control (one set of programmes for weekdays and a different set for weekends).

## Before you start/Making a Full Reset

---

- ❑ Open the flap on the front of the unit.
- ❑ Press and hold **+1HR** and **MAN** buttons.
- ❑ Press and release the **R/S** button using a small, non-metallic object (e.g. matchstick, biro tip).
- ❑ Release **+1HR** and **MAN** buttons.

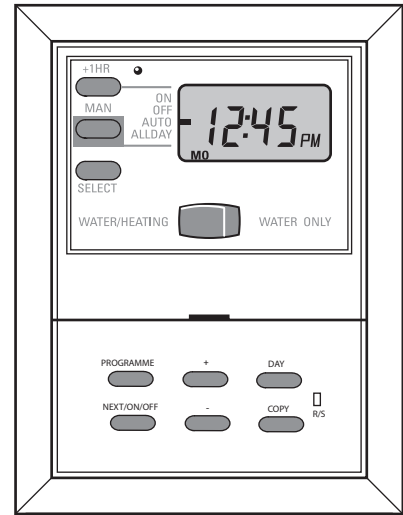

*This will reset the unit, reinstate the preset programmes and set the time to 12:00pm on Monday.*

## Choice of 24hr or AM/PM display

Press and hold **DAY** and **NEXT ON/OFF** buttons for 1.5 seconds to toggle between 24hr clock and AM/PM display, as required.

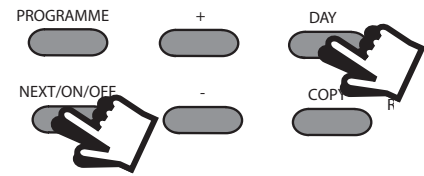

## Setting the correct Time and Day

### Setting the Date

Press and hold **PROG** for 5 seconds to display year.

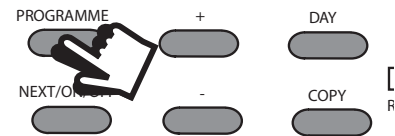

Use the + or - buttons to set the correct year.

Press **DAY** to display day and month. Use the + or - buttons to set the correct month (Jan=1, Feb=2 etc.).

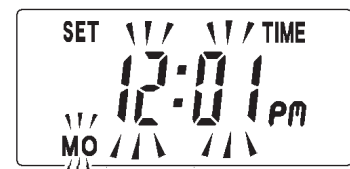

Press **DAY** to display day and month. Use the + or - buttons to set day of month.

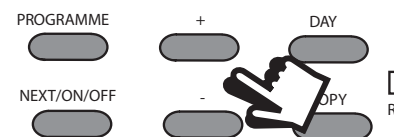

Press **PROG** to display the time.



The words **SET TIME** will appear at the top of the display and the time will flash on and off.



Use the + or - buttons to set the correct time (press and hold to change in 10 minute increments).

### *Setting the Day*

The day of the week is set automatically. Press **PROG** to exit into **RUN** mode.

## **Factory Presets**

The unit is supplied with the following preset programme which will be active after the unit has been reset.

	<b>Mon-Fri</b>	<b>Sat-Sun</b>
1st ON	6.30am	7.30am
1st OFF	8.30am	10.00am
2nd ON	12.00pm	12.00pm
2nd OFF	12.00pm	12.00pm
3rd ON	5.00pm	5.00pm
3rd OFF	10.30pm	10.30pm

NB. 2nd ON and 2nd OFF are set to the same time. These 2 times are ignored by the programme therefore the heating will just come on once in the morning and once in the evening. If you want the heating to come on in the middle of the day set the 2nd ON and 2nd OFF to the times you require.

## **Accepting the preset times**

If you are happy to use the settings above, you don't need to do anything else.

To accept the presets press the **PROGRAMME** button until the colon in the display begins to flash.

Your unit is now in **RUN** mode.



## Before you change the preset programmes

---

Your installer will have set your unit to operate in one of the following modes:

- **7 day** - different settings for each day of the week (**page 16-17**) - **default setting**
- **5/2 day** - one set of programmes for weekdays and another for weekends (**page 18-19**)

! Please follow the correct instructions to programme your unit.

### ***Please Note***

The unit must be programmed in sequence and ON/OFF times cannot be set out of sequence.

If you want to leave a preset time as it is, simply press **NEXT ON/OFF** to move on to the next setting

Your clock will allow you to programme 3 ON/OFF settings per day. If you do not wish to use one of the ON/OFF settings, simply programme the ON time to be the same as the OFF time and the setting will not operate.

! If at any time you get confused and need to reset your timings to the standard preset programme, press the **R/S** button to return to the preset programmes.

# Programming the heating & hot water in 7-day mode

1. Press **PROGRAMME** until **SET ON TIME** appears at the top of the display and press **DAY** until **MO** appears at the bottom of the display.

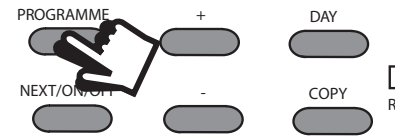

Use the + and - buttons to set the time you want your heating to first come on in the morning (Event 1).

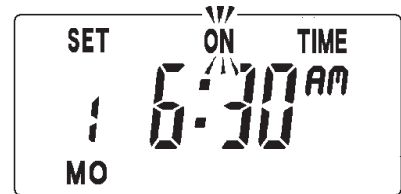

2. Press **NEXT ON/OFF** to move to Event 2.

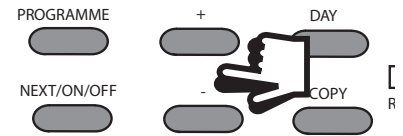

Either press **COPY** to use the same settings as the day before or continue to programme the central heating ON and OFF times, using the + and - buttons to set the time you want and pressing the **NEXT ON/OFF** button to move to the next setting.

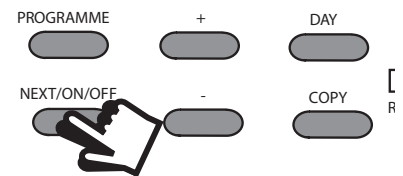

3. Press **DAY** button once only. **TU** will appear at the bottom of the display.

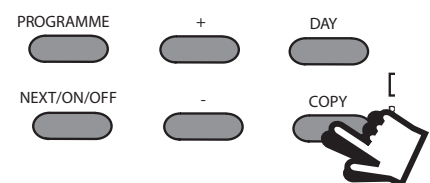
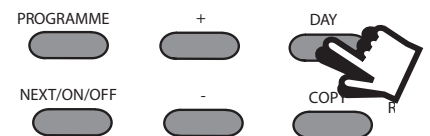



Continue programming the rest of the week by pressing:

a) **NEXT ON/OFF** button to move to the next setting,

b) **+ and -** buttons to amend the time

c) **DAY** to advance to the next day.

Alternatively press **COPY** to keep the same settings as the day before

4. Press the **PROGRAMME** button to return the unit to **RUN** mode
5. **Proceed to page 20.**

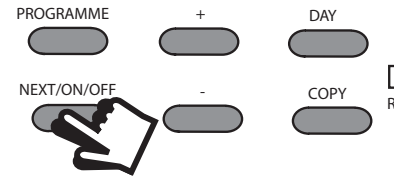

To advance to next time setting

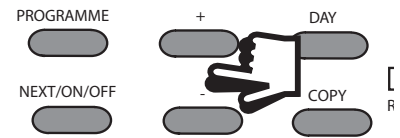

To amend **TIME**

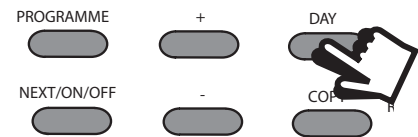

To move to next **DAY**

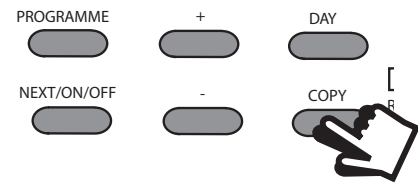

**COPY** previous event times

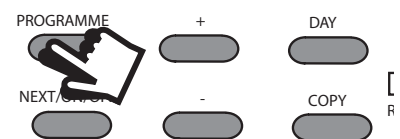

Return to **RUN** mode

# Programming the heating & hot water in 5/2 day mode

1. Press **PROG** until **SET ON TIME** appears at the top of the display and press **DAY** until **MOTUWETHFR** appears at the bottom of the display.

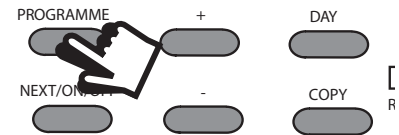

Use the + **and** - buttons to set the time you would like your heating/hot water to first come on in the morning (Event 1).

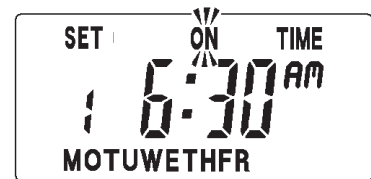

2. Press **NEXT ON/OFF** once only.

Use the + **and** - buttons to set the time you want your heating/hot water to go off (Event 2).

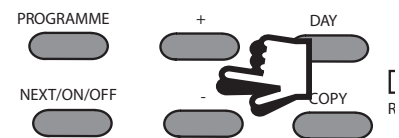

To move to the next setting, i.e. when you would like your heating/hot water to come on again (Event 3) press the **NEXT ON/OFF** button again.

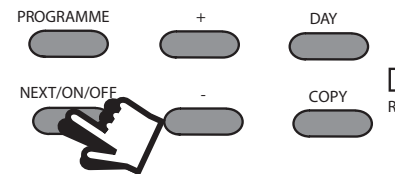

3. Continue programming the heating/hot water ON and OFF times for weekday Events 4, 5 & 6 as in Step 2.

4. Press the **DAY** button once and **SASU** will appear at the bottom of the display.

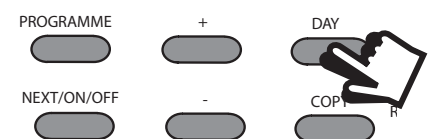

Either press **COPY** to keep the same settings for Saturday and Sunday as you have programmed for Monday to Friday.

Alternatively, programme new ON/OFF times by pressing the **NEXT ON/OFF** button to move to the next setting and using the + and - buttons to set the time you want.

5. Press the **PROG** button to return the unit to RUN mode
6. **Proceed to page 20.**

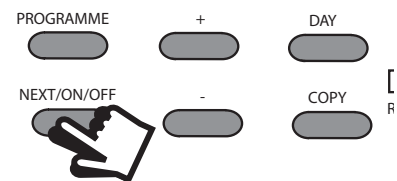
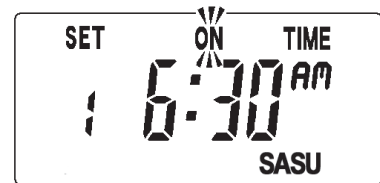
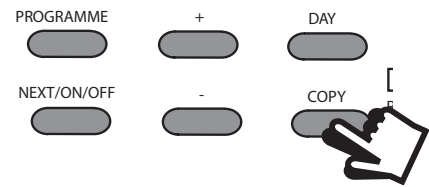

To advance to next time setting

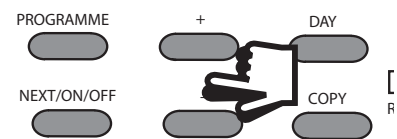

To amend **TIME**

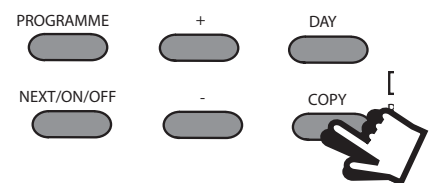

**COPY** previous event times

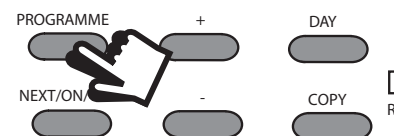

Return to **RUN** mode

## Running your programme

The 102E7 will either control your hot water and heating together, or just your hot water (i.e. during the summer, when heating is no longer required).

To make your selection use the rocker switch under the LCD display to select either **WATER/HEATING** or **WATER ONLY**



To run the central heating and/or hot water programme press the **SELECT** button.

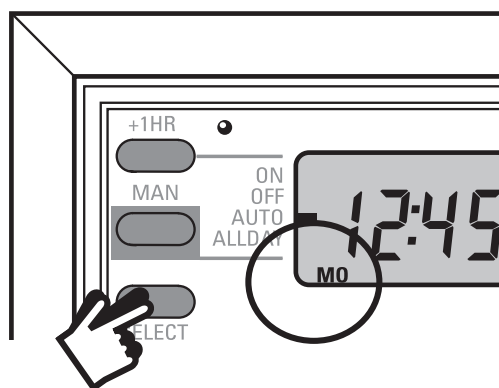

As you press **SELECT** a bar on the display will move between **ON**, **OFF**, **ALLDAY** and **AUTO**

**RUN mode**

- **ON** = the hot water/heating will remain on constantly
- **OFF** = the hot water/heating will not come on
- **AUTO** = the hot water/heating will come on and go off according to the programmed times
- **ALLDAY** = the unit will come on at the first programmed ON and will remain on until the last programmed OFF.

Select the option you require, depending on your circumstances, time of year, etc.

## Temporary User Overrides

---

Sometimes you may need to need change the way you use your heating temporarily, i.e due to unusually cold weather. The 102E7 has two convenient overrides which can be selected without affecting the set programme.

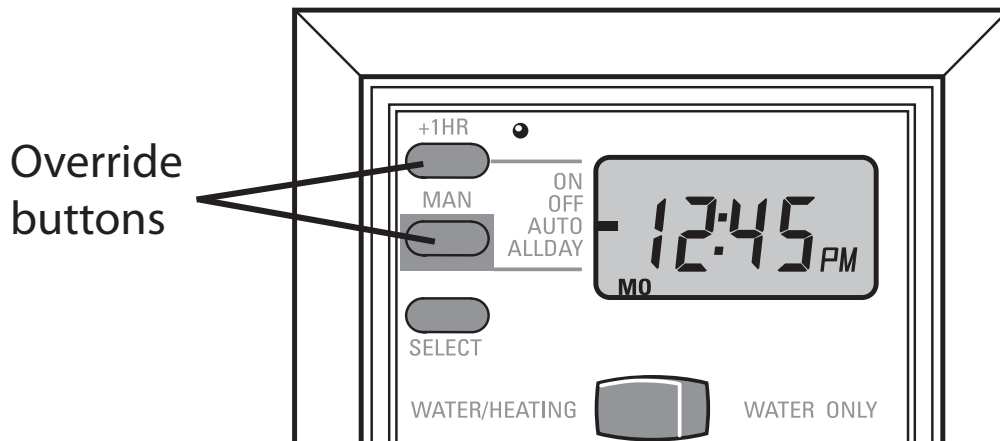

### +1HOUR

- ❑ Press **+1HOUR** once if you need **an extra hour of operation** (a red light will come on)

*If the system is off it will come on for an hour. If it is already on it will add an extra hour so the system stays on for an extra hour.*

- ❑ To cancel the override press +1HOUR again (red light will go off). Otherwise the override will self-cancel at the next programmed event.

### MAN

- ❑ Press **MAN** button once to manually override the programme (only whilst unit is set to AUTO or ALLDAY) (a red light will come on)

*If the system is on it will go off. If it is off it will come on. The set programme will resume at the next programmed ON/OFF time.*

- ❑ To cancel the override press MAN again (red light will go off).

## Battery backup

---

In the event of a power cut, the built-in battery will keep your time and programme settings for up to 2 days.

After 2 days without mains power the date and time will be lost.

When mains power is restored, the unit should be RESET, by pressing the **R/S** button beneath the flap, using a small non-metallic object, i.e. matchstick, biro tip (see page 12).

Then reprogramme date and time.



# Still having problems?

*Call your local heating engineer:*

Name: .....

Tel: .....

*Visit our website:*

**[www.danfoss-randall.co.uk](http://www.danfoss-randall.co.uk)**

*Email our technical department:*

**[drl\\_technical@danfoss.com](mailto:drl_technical@danfoss.com)**

*Call our technical department*

**0845 121 7505**

*(8.45-5.15 Mon-Thurs, 8.45-4.45 Fri)*

**For a large print version of these instructions please contact the Marketing Services Department on 0845 121 7400.**



**Danfoss Randall Ltd**

Amphill Road

Bedford

MK42 9ER

Tel: 01234 364621

Fax: 01234 219705

