

Please keep these Instructions safe.  
Should you move house, please hand  
them over to the next occupier.

# Baxi Bermuda SP3/VP3

Fireside Gas Central Heating Unit

---

## User's Operating Instructions

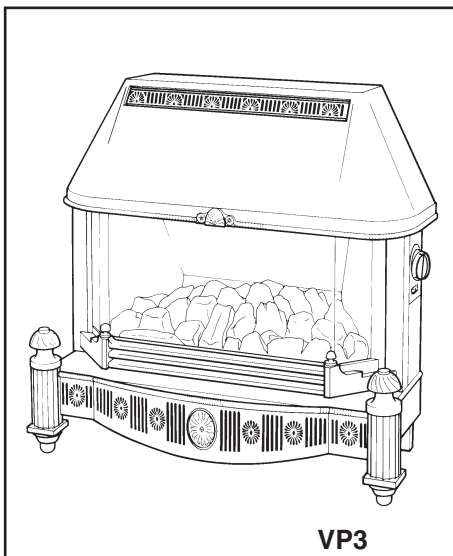
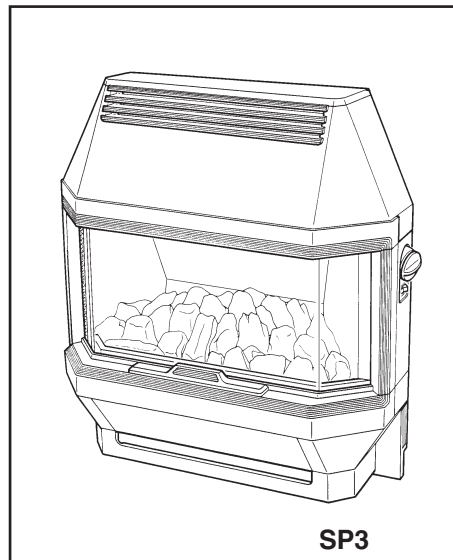

# BAXI

## Natural Gas

---

**Baxi Bermuda SP3**  
G.C.No. 37 077 63

**Baxi Bermuda VP3**  
G.C.No. 37 077 62

### For use with the following boilers:

**Baxi Bermuda 45/4 M**  
G.C.No. 44 077 71  
**Baxi Bermuda 45/4 E**  
G.C.No. 44 077 73  
**Baxi Bermuda 57/4 M**  
G.C.No. 44 077 72  
**Baxi Bermuda 57/4 E**  
G.C.No. 44 077 74  
**Baxi Bermuda 51/5**  
G.C.No. 44 075 06

## Propane Gas

---

**Baxi Bermuda VP3 Propane**  
G.C.No. 37 077 72

**Baxi Bermuda 553 Propane**  
G.C.No. 44 077 75

### For use with the following boiler:

## Renewal

---

**Baxi Bermuda SP3 Renewal**  
G.C.No. 37 075 05A

**Baxi Bermuda VP3 Renewal**  
G.C.No. 37 075 04A

### For use with the following boilers:

**Baxi Bermuda 401**  
G.C.No. 44 077 49  
**Baxi Bermuda 552**  
G.C.No. 44 077 50  
**Baxi Bermuda 45/3 M**  
G.C.No. 44 077 61  
**Baxi Bermuda 45/3 E**  
G.C.No. 44 077 60  
**Baxi Bermuda 57/3 M**  
G.C.No. 44 077 63  
**Baxi Bermuda 57/3 E**  
G.C.No. 44 077 62  
**Baxi Bermuda 45/4 M**  
G.C.No. 44 077 71  
**Baxi Bermuda 45/4 E**  
G.C.No. 44 077 73  
**Baxi Bermuda 57/4 M**  
G.C.No. 44 077 72  
**Baxi Bermuda 57/4 E**  
G.C.No. 44 077 74  
**Baxi Bermuda 51/5**  
G.C.No. 44 075 06

Baxi is one of the leading manufacturers of domestic heating products in the UK.

Our first priority is to give a high quality service to our customers. Quality is built into every Baxi product - products which fulfil the demands and needs of customers, offering choice, efficiency and reliability.

To keep ahead of changing trends, we have made a commitment to develop new ideas using the latest technology - with the aim of continuing to make the products that customers want to buy.

Baxi is also the largest manufacturing partnership in the country. Everyone who works at the company has a commitment to quality because, as shareholders, we know that satisfied customers mean continued success.

We hope you get a satisfactory service from Baxi. If not, please let us know.



Baxi is a BS-EN ISO 9001  
Accredited Company

**Codes of Practice**, most recent version should be used

**In GB the following Codes of Practice apply:**

<b>Standard</b>	<b>Scope</b>
BS 6891	Gas Installation.
BS 5546	Installation of hot water supplies for domestic purposes.
BS 5871	Installation of gas fires, convector and fire/back boilers.
BS 5440 Part 1	Flues.
BS 5440 Part 2	Ventilation.
BS 6798	Installation of gas fired hot water boilers.
BS 5449 Part 1	Forced circulation hot water systems.

**In IE the following Codes of Practice apply:**

<b>Standard</b>	<b>Scope</b>
I.S. 813	Domestic Gas Installations.
The following BS standards give valuable additional information;	
BS 5546	Installation of hot water supplies for domestic purposes.
BS 5449 Part 1	Forced circulation hot water systems.

**IMPORTANT** - The addition of anything that may interfere with the normal operation of the appliance without express written permission from the manufacturer or his agent could invalidate the appliance warranty. In GB this could also infringe the **GAS SAFETY** (Installation and Use) **REGULATIONS**.

#### **IMPORTANT - Installation, Commissioning, Service & Repair**

This appliance must be installed in accordance with the manufacturer's instructions and the regulations in force. Read the instructions fully before installing or using the appliance.

In GB, this must be carried out by a competent person as stated in the Gas Safety (Installation & Use) Regulations.

Definition of competence: A person who works for a CORGI registered company and holding current certificates in the relevant ACS modules, or valid ACoP equivalents, is deemed competent.

In IE, this must be carried out by a competent person as stated in I.S. 813 "Domestic Gas Installations".

#### **"Benchmark" Installation, Commissioning and Service Record Log Book**

Please ensure that your installer has completed the Installation and Commissioning sections of the Log Book and hands the Log Book over. The details of the Log Book will be required in the event of any warranty work. Keep the Log Book in a safe place and ensure that the relevant sections are completed at each subsequent regular service visit.

All CORGI registered installers carry a CORGI identification card and have a registration number. Both should be recorded in your boiler Log Book. You can check your installer is registered by telephoning +44 (0)1256 372300 or writing to:-  
1 Elmwood,  
Chineham Business Park,  
Crockford Lane,  
Basingstoke. RG24 8WG

# Warnings

## Safe Installation

**The appliance is suitable only for installation in GB and IE and should be installed in accordance with the rules in force.**

In GB, the installation must be carried out by a CORGI Registered Installer. It must be carried out in accordance with the relevant requirements of the:

- Gas Safety (Installation & Use) Regulations.
- The appropriate Building Regulations either The Building Regulations, The Building Regulations (Scotland), Building Regulations (Northern Ireland).
- The Water Fittings Regulations or Water Byelaws in Scotland.
- The Current I.E.E. Wiring Regulations.

Where no specific instructions are given, reference should be made to the relevant British Standard Code of Practice.

In IE, the installation must be carried out by a competent Person and installed in accordance with the current edition of I.S. 813 'Domestic Gas Installations', the current Building Regulations and reference should be made to the current ETCI rules for electrical installation.

**Read the instructions before installing or using this appliance.**

**Never hang clothes or other items over the appliance.**

## In case of gas leaks

1. **If a gas leak is found or suspected**, turn off the gas supply at the meter immediately and call your gas supplier.

## Servicing your boiler

1. We strongly recommend that your Bermuda is serviced annually by a competent person for economic and safety reasons. Your Installer will be able to advise you.

## Electricity supply

### **1. THIS APPLIANCE MUST BE EARTHED**

A standard 230 volt ~ 50Hz supply is required. The appliance must be protected by a 3 amp fuse.

## Fault

1. If it is either known or suspected that a fault exists on the appliance, it **must not be used** until the fault has been corrected by a competent person.

## Introduction

Your Baxi Bermuda SP3 or VP3 is a central heating boiler combined with a gas fire. Normally the fire will heat the room in which it is situated and the boiler will provide heating for the rest of the house and also domestic hot water if required. The boiler and fire are independently controlled.

The boiler may be controlled by an external programmer or clock control (see separate instructions with the clock controller used). The fire is controlled by the knob which is located on the right hand side of the outer case.

### Important Notice

The Bermuda VP3 Propane appliance is for use on **PROPANE GAS ONLY** and cannot be used on any other gas. Propane appliances can be converted to operate on Natural Gas if required at a later date. Consult your Installer

### WARNING

Bermuda SP3 and VP3 Renewal Firefronts **MUST NEVER** be fitted as independent gas fires without the boiler.

### Important Information

This product uses a fuel effect coal bed containing Refractory Ceramic Fibres (R.C.F.) which are man-made vitreous silicate fibres. Excessive exposure to these materials may cause temporary irritation to eyes, skin and respiratory tract. Care must be taken when handling these articles to ensure the release of dust or fibres is kept to a minimum. Refer to the section Cleaning the Fire.

**NOTE:** When your Bermuda is first used it is possible that certain smells may be emitted. These smells will quickly clear with use. As the fire is used more and more, the bright finished metal around the coal bed will begin to darken. This is perfectly normal and will enhance the realism of the coal and flame effect.

Most heating appliances generate warm air convection currents and transfer heat to any wall surface against which they are situated. Some soft wall furnishings (such as blown vinyl wallpapers) may not be suitable for use where they are subjected to temperatures above normal room levels. The manufacturers advice should be sought before using this type of wall covering adjacent to any heating appliance. The likelihood of wall staining from convected air currents will be increased in environments where high levels of tobacco smoke or other contaminants exist.

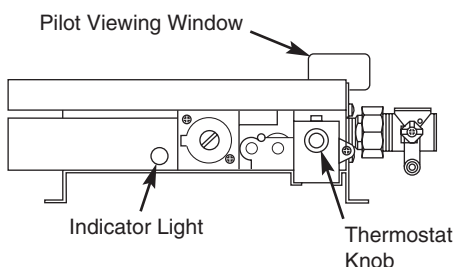

**Electronic Controls Boiler**

(51/5)

## OPERATING THE UNIT

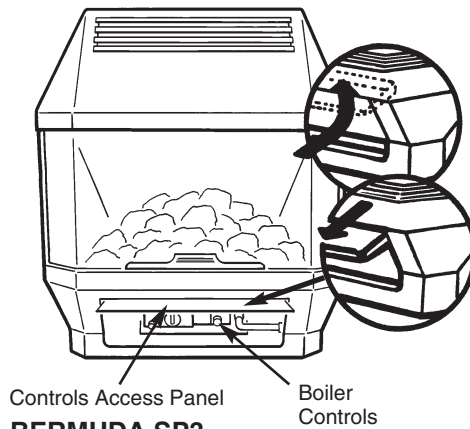

**BERMUDA SP3**

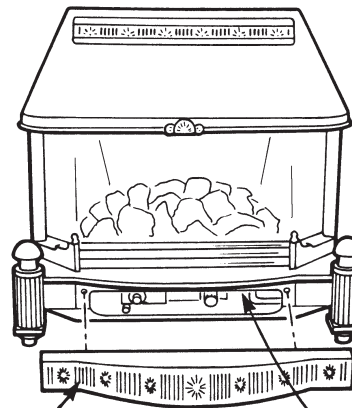

**BERMUDA VP3**

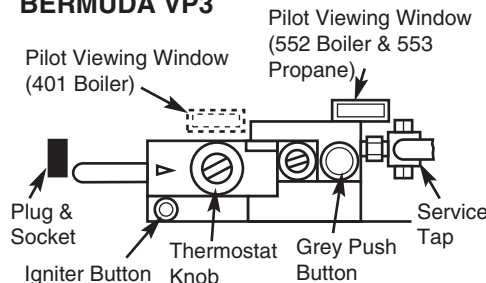

**Manual Controls Boiler**

(401 & 552 & 553 Propane)

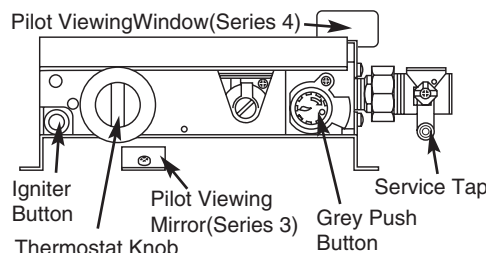

**Manual Controls Boiler**

(45/3M, 57/3M, 45/4M & 57/4M)

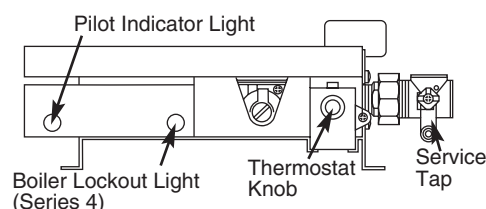

**Electronic Controls Boiler**

(45/3E, 57/3E, 45/4E & 57/4E)

**1** Ensure that the fire is cold. **(Bermuda SP3)** Open the controls access panel by pushing inward at the bottom. Lift the panel and pull forward to fix in the open position. **(Bermuda VP3)** Remove the fender front at the bottom of the fire by pulling forward.

**2** Turn the boiler thermostat knob to the off position (●).

Manual Controls Boiler



Electronic Controls Boiler

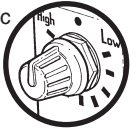

**3** Turn on the main gas and electricity supplies to the appliance.

**4 TO LIGHT THE BOILER PILOT: (Manual Controls Boiler)** Hold in the grey push button on the gas control valve. Looking through the pilot viewing window or mirror: Press the igniter button and release. Repeat until the pilot lights. Continue to hold in the grey push button for a further 15 seconds. The pilot should stay alight.

**NOTE:** If the pilot fails to remain alight or is extinguished at any time, wait at least 3 minutes then repeat step 4. Once the pilot is alight it may be left on permanently.

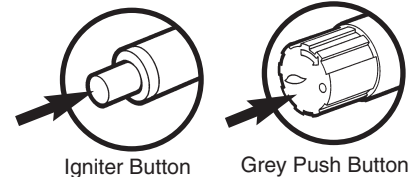

**5 TO LIGHT THE BOILER: (Manual Controls Boiler)** Ensure that all external controls, e.g. room thermostat, timer etc., are calling for heat. Turn the boiler thermostat knob to the desired position.

**6 TO LIGHT THE BOILER: (Electronic Controls Boiler)** Ensure that all external controls, e.g. room thermostat, timer etc., are calling for heat. To operate the pilot turn the thermostat knob to the desired position. The indicator light on the control box will illuminate once the pilot is lit. The burner will also light shortly after the pilot has been established.

**To adjust the boiler temperature:** Turn the boiler thermostat knob clockwise to the required setting. The optimum boiler thermostat setting depends upon type of system, external controls and your requirements. Your Installer will be able to advise you on this matter.

**If the boiler cannot be lit by the above method consult your Service Engineer.**

## 7 RESETTING THE BOILER: (Electronic Controls Boiler)

(45/3E, 57/3E, 45/4E & 57/4E)

If the boiler lockout light is illuminated it is necessary to reset the appliance. To do this turn the boiler thermostat control knob fully anti-clockwise to the OFF position and wait 10 seconds. Turn the control knob to the required setting. The boiler will commence sparking providing the water temperature is sufficiently cool.

(51/5)

If the indicator light is illuminated red/or flashing red, it is necessary to reset the appliance. To do this turn the boiler thermostat control knob fully anticlockwise to the OFF position and wait until the light shows orange. Turn the control knob clockwise to the required setting. The boiler will commence the ignition sequence.

## 8 TO LIGHT THE FIRE:

Push in the control knob. Turn to the IGNITION position (★) and hold. Sparking will commence and the pilot will ignite. Continue to hold the control knob in position for a further 15 seconds then release. The pilot should stay alight.

**NOTE:** If pilot or the fire fail to remain alight or are extinguished at any time, wait at least 2 minutes then repeat the procedure from the start of "8 TO LIGHT THE FIRE". Once lit the pilot may be left on permanently.

**CONTROL KNOB POSITIONS:** The control knob has six positions giving a choice of 5 settings, i.e.

- Position ● - OFF
- Position ★♂ - IGNITION/PILOT
- Position 1 - LOW
- Position 2 - MEDIUM
- Position 3 - MED/HIGH
- Position 4 - HIGH

To adjust the fire to the required setting, push in the control knob and turn in the appropriate direction.

## 9 TO TURN THE FIRE OFF:

Push in the control knob and turn clockwise to the OFF position. The pilot light can be left on by stopping at the ★♂ position but the fire is not completely off until the control knob is turned to position ●.

## LIGHT EFFECT

The light effect is operated by a switch below the control knob and may be used either with or without the fire being on.

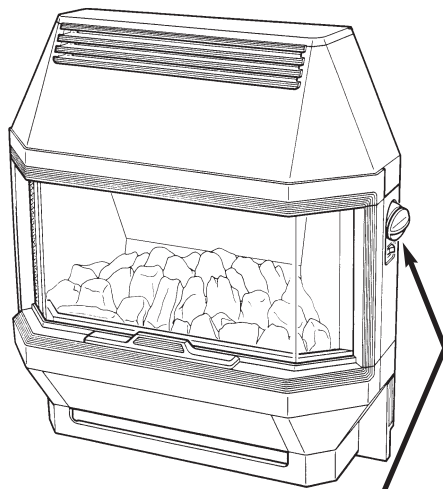

BAXI BERMUDA SP3

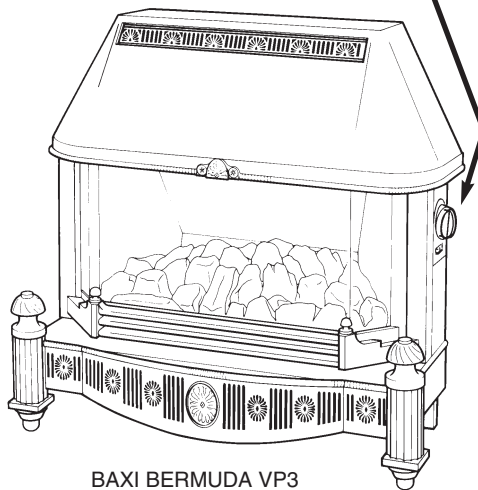
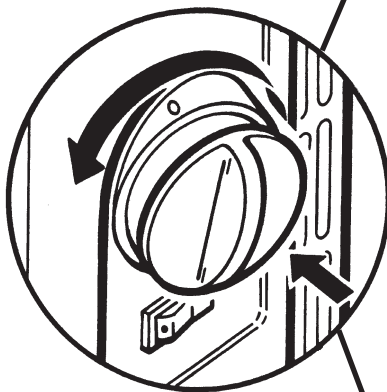

BAXI BERMUDA VP3

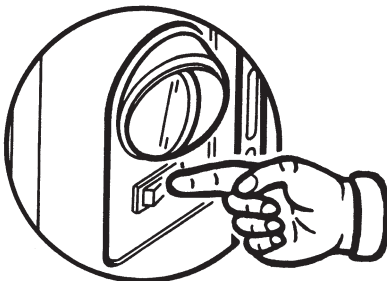

## TO SHUT DOWN THE BOILER

**(Bermuda SP3)** Open the controls access panel by pushing forward at the bottom. Lift the panel and pull forward to fix in the open position.

**(Bermuda VP3)** Remove the fender front at the bottom of the fire by pulling forward.

**To switch the boiler off for short periods. (Manual Controls Boiler)** Turn the boiler thermostat knob to the OFF position (●). The pilot will remain alight.



**To switch the boiler off for long periods. (Manual Controls Boiler)** Turn the grey push button clockwise and release. Turn the boiler thermostat knob to the OFF position (●).

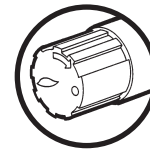

**To switch the boiler off. (Electronic Controls Boiler)** Turn the thermostat knob to the OFF position (●).

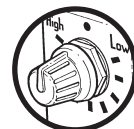

If you are shutting down both the fire and boiler, isolate the electrical supply that serves the system controls i.e. Timer/Programmer.

Replace the controls cover panel.

**NOTE:** If the boiler is left off for long periods during cold weather, it is recommended that the whole system is drained to avoid frost damage. Advice on draining the system can be obtained from your Service Engineer.

## GUARDING

The glass front panel on this appliance conforms to the required safety standards. It does not give full protection to the young or infirm: in such cases we recommend a nursery type guard which conforms to BS 6539. The panel becomes very hot when the appliance is in use and must not be touched.

**THE APPLIANCE MUST NEVER BE USED WITHOUT THE GLASS FRONT PANEL FITTED.**



## RESTRICTED ACCESS: REPLACEMENT OF BULBS

In certain installations (i.e. where the clearances to the sides of the fire are less than 100mm (4in.)) it is necessary to remove the side doors to gain access to the bulbs, should they ever need changing. This is done by first of all removing the canopy as described on the next page (under "REMOVAL OF GLASS FRAME").

Remove the side doors by opening them out and lifting away from the fixing studs shown in the illustration on the next page. The bulbs may now be replaced as described in the relevant section. ("REPLACING THE BULBS")

## CLEANING THE FIRE

Ensure that the fire is cold. The painted panels and metalwork should be wiped with a damp cloth and dried thoroughly with a lint-free cloth. **Do not use a silicone based polish on any part of the fire.** The glass may be cleaned with a non-abrasive cream cleanser. Clean the glass regularly for best results.

**NOTE:** Both sides of the glass must be cleaned after the first week of using the fire.

It is possible that some soot may be deposited on the coals after use. This is acceptable providing it is not allowed to accumulate. Should any soot accumulation become excessive the fuel effect coal bed should be removed from the fire for cleaning. To remove the coal bed it is necessary to remove the glass front panel. It is recommended that gloves are worn when handling the coal bed, which is extremely fragile and must be handled accordingly. Cleaning should be carried out in a well-ventilated area or the open air by gently brushing with a soft brush with the coal bed held away from the face to avoid inhaling the dust. The use of a normal domestic vacuum cleaner is not recommended as it may blow dust back into the air. Care must also be taken if retouching the coal bed is required. Keep the coal bed away from children at all times. Never use coals other than those supplied or Genuine Baxi Spare Parts. Never put additional coals on the fire. Always wash hands thoroughly after handling the coal bed. Please read the Important Information section on page 4. The coal bed may be retouched using black stain. This is available direct from Baxi or your local Baxi Spares Stockist. Quote part N° 043224.

The minimum clearance spaces around the Baxi Bermuda SP3 are:

Top: 76mm (3 in)  
Side (RH): 100mm (4 in)  
Side (LH): 76mm (3 in)

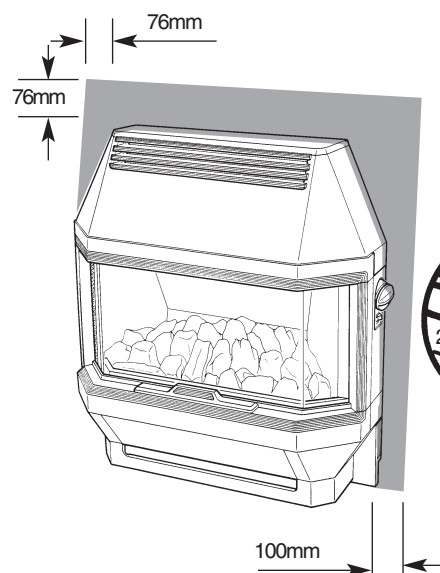

The minimum clearance spaces around the Baxi Bermuda VP3 are:

Top: 76mm (3 in)  
Side (RH): 100mm (4 in)  
Side (LH): 76mm (3 in)

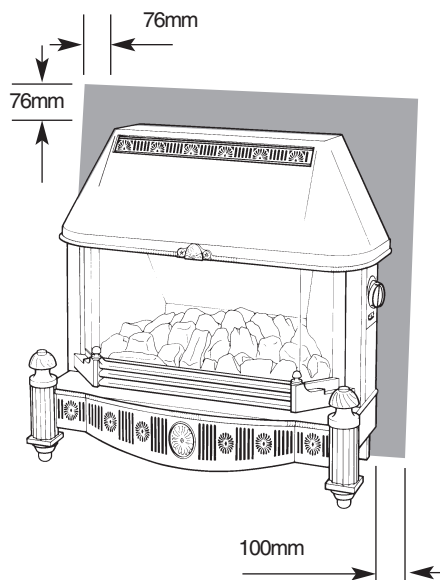

## CLEARANCES AROUND THE FIRE

These clearances must not be reduced or obstructed in any way. Reducing the clearances above the fire may lead to damage to any overhanging shelf or fire surround by overheating. Reducing the clearances to the sides of the fire means that access to the control knob is reduced and it becomes impossible to replace the bulbs as described in the text "REPLACING THE BULBS".

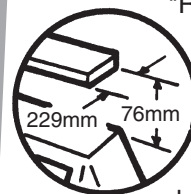

(See RESTRICTED ACCESS: REPLACEMENT OF BULBS)

A shelf may be fitted not less than 76mm (3 in) above the fire and not more than 229mm (9 in) in depth.

## SURROUND OR WALL FINISH

The surround or wall finish must have a flat vertical area centrally placed about the opening.

If a surround is fitted, any gaps between it and the wall must be sealed and it must have a rating of 100° C or higher.

## PILOT/A.S.D.

Both the boiler and firefront are fitted with a pilot light that also acts as an Atmospheric Sensing Device. This means that in the event of the flow of gases out of the flue being interrupted the pilots will extinguish and shut the fire and boiler down. If this occurs persistently your Service Engineer should be contacted immediately. **Renewal firefronts are fitted with an Atmospheric Sensing Device (A.S.D.). If they are installed in conjunction with a boiler NOT fitted with an A.S.D. (i.e. 401, 552, 45/3 & 57/3), under adverse flue conditions the boiler WILL NOT shut down. It is important that the appliance is regularly serviced to ensure correct operation of the Atmospheric Sensing Device.**

## REMOVAL OF GLASS FRAME

**CAUTION:** The appliance must never be used without the glass front panel fitted. Should the glass front panel become damaged or cracked the fire should not be used until it has been replaced.

**NOTE:** This is a heat resistant glass and must not be replaced by ordinary glass. Some small blemishes may be seen in the glass. These are inherent in its manufacture and will not affect its performance or durability.

Ensure that the fire is cold and then remove the canopy following the appropriate instructions.

Remove the Bermuda VP3 canopy by gently easing the sides inwards and the bottom edge forward, then lift the canopy upwards and away from the locating lip. Open out the doors.

Remove the Bermuda SP3 canopy, firstly by opening the side doors, then lift the canopy by the bottom edge upwards and away from the locating lip.

Unlock the retaining clips fixing the glass frame in position and lift the frame away.

To replace the glass frame, place the bottom edge in the locating channel and push against the sealing rope. Engage the retaining clips. This ensures an effective seal between the glass frame and the fire front.

To replace the Bermuda VP3 canopy close the doors and re-locate the canopy on the locating lip and then by gently easing the sides inwards, push home to lock in place.

To replace the Bermuda SP3 canopy guide the bottom edge onto the door pins and then by tilting the back edge over the locating lip. Close the doors ensuring they lock in place.

## IGNITION WITH A MATCH

In the event of an interruption to the electricity supply to your Bermuda, it is possible to light the fire pilot using a match. To do this, remove the glass frame as described above and apply the lighted match to the gap between the coals and front panel in the centre, whilst otherwise following the instructions ("TO LIGHT THE FIRE"). Once the fire pilot is lit, replace the glass frame immediately.

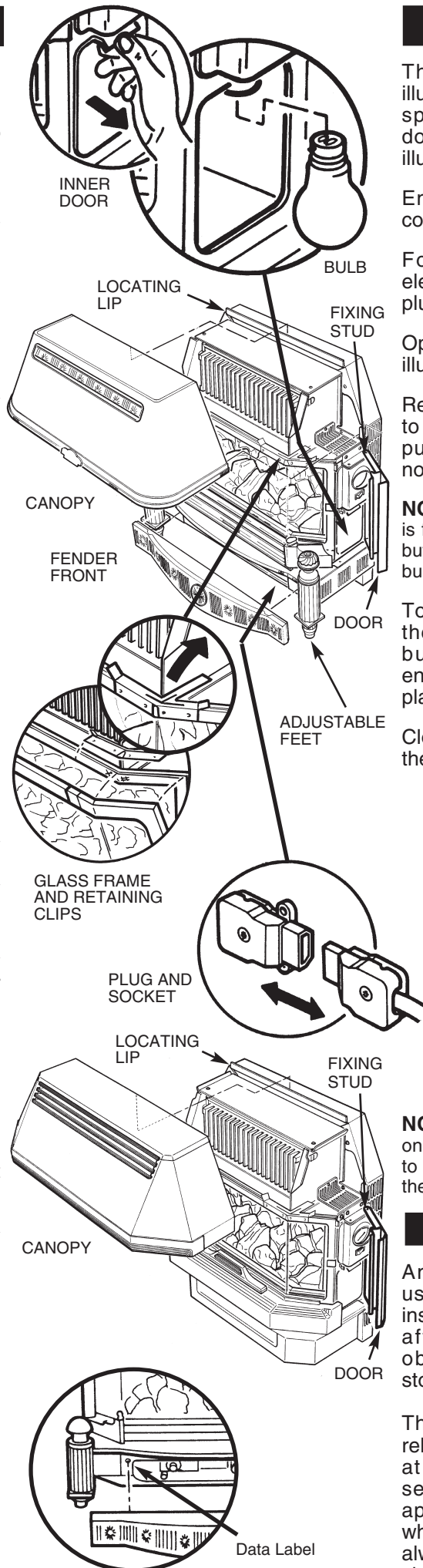

## REPLACING THE BULBS

The bulbs which provide artificial illumination for the fire are situated in special compartments behind the doors which open as shown in the illustration.

Ensure that the fire and bulbs are cold.

For safety reasons, isolate the electricity supply by disconnecting the plug from the socket, as shown.

Open out the doors as shown in the illustration.

Remove the inner door to gain access to the bulbs by grasping the lip and pulling firmly on it. The bulbs may now be replaced.

**NOTE:** For the best visual effect the fire is fitted with standard 40 W orange bulbs, but if desired can be replaced with other bulbs up to a maximum of 60 W.

To replace the inner doors, engage the bottom edge in position in the bulb housing and push home, ensuring that the spring clip locks in place.

Close the outer doors and reconnect the plug into the socket.

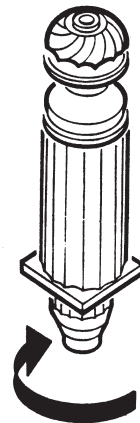

**NOTE:** If necessary the adjustable feet on VP3 models may be raised or lowered to touch the fireplace hearth by turning in the appropriate direction.

## SPARE PARTS

Any repairs to the appliance will usually be the responsibility of the installer during the guarantee period, after which spare parts may be obtained through approved Baxi stockists if required.

The spare parts available and their relevant G.C. numbers can be found at the back of the installation and servicing instructions booklet. The appliance name and G.C. number, which are on the data badge, should always be quoted. The data badge is visible on the left hand fire support leg when the controls cover is removed.

## Guarantee

1. Your Baxi Bermuda is designed and produced to meet all the relevant Standards.
2. Baxi provide a 3 year guarantee on the Bermuda - other parts of the system are covered by the Installer or other manufacturers. The guarantee operates from the date installation is completed for the customer who is the original user.
3. To maximise the benefit from our guarantee we urge you to return the reply-paid guarantee registration.
4. This does not in any way prejudice your rights at Common Law. Such rights between the customer and the installer or supplier from whom the unit was purchased remain intact.

**Any component or part (with the exception of the bulbs) which becomes defective during the guarantee period as a result of faulty workmanship or material whilst in normal use will be repaired or replaced free of charge.**