



## K VENT

**Twin wall insulated venting system for oil (28 sec) and gas appliances.**

- Oil appliances up to 45kW output
- Gas appliances up to 60kW input
- 100-150mm internal diameter
- Residential and small commercial applications
- Interfits with B Vent gas vent



Manufactured in accordance with OFSE 106 Chimney Code E1/E3.



DOC/CP3/47 Issue 4 March 2009



**MONIER**

## Application

**Twin wall insulated venting system** specifically designed for residential and small commercial kerosene (**28 second oil**) and gas appliances. Especially useful on exposed external runs or cold roof spaces. BS5440-1-2000 5.1.7 requires the use of stainless steel insulated flue on all exterior gas flue runs exceeding 3 metres. K Vent fulfills this requirement and interconnects directly with the B Vent gas flue system for the most cost-effective solution.

K Vent is suitable for appliances that operate with a flue gas temperature that does not exceed 250°C. K Vent is only suitable for appliances that operate zero or negative pressure at the appliance outlet. For appliances that operate outside these conditions please refer to other products in the range or contact the installer helpline.

## Product Description

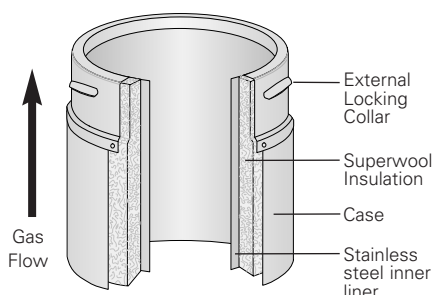

- **Twist-lock bayonet jointing system.**
- **No locking bands required.**
- **Corrosion resistant laser-welded 304 stainless steel liner.**
- **The case in aluzink which may be painted if required.**
- **The 12.5 mm high efficiency Superwool™ blanket maintains the flue gas temperature, maximising efficiency, improving flue draught on start-up and minimising condensation.**
- **Low external case temperature.**
- **The liner held rigidly by the male locking collar but free to expand and contract with temperature change through the female collar.**
- **When joint is made, the liner covers the jointing collar, shielding it and permitting easy drain-down of any condensate in the flue.**

## Flue Sizing

### Flue Size Selection Guide

	100mm	125mm	150mm
Kerosene Central Heating Boiler - Output up to 25kW Output 25kW-45kW Output 45kW-60kW	●	●	●
Kerosene Stove/Cooker -	●	●	●
Kerosene Water Heaters - Input up to 41kW			●
Kerosene Visual Effect Heater - Output up to 17kW	●	●	
High Efficiency Gas Fires - 'Radiant' to BS7977-1 2002 'Inset' to BS7977-1 2002 'Backboiler' to BS7977-2 2003		● ●* ●	
Gas Flue Blocks - Connection OUT		●	

Notes:- \*Subject to appliance manufacturer's testing criteria

### Flue size selection

K Vent is available in 100, 125 and 150mm internal diameters. The flue size must be as recommended by the appliance manufacturer and **must not** be reduced, and never smaller than the appliance spigot.

This information is provided as a guide only, and for exact flue sizing recommendations, refer to appliance manufacturer's installation instructions and design guide.

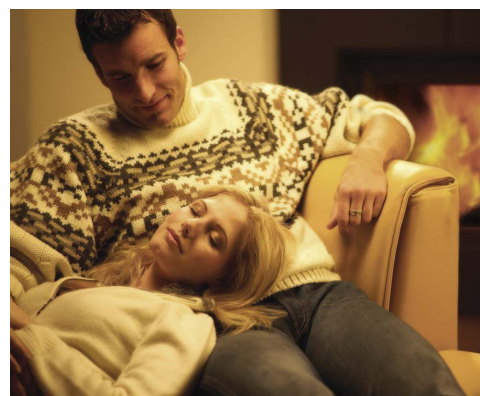

## Approvals

K Vent is **CE certified to EN1856-1 with the designation T250 NI D Vm L20045 050 (certificate number 0036CPD9195014)**. It is also kitemarked to BS715 1993 (certificate number KM5518 in 100 and 125 diameters) and is manufactured under the Quality Assurance requirements of BS EN ISO 9001:2000. This satisfies the Building Regulations (England, Wales and Northern Ireland) for gas and kerosene appliances having a flue gas temperature of 250°C maximum, and K Vent has been granted a class relaxation pending revision of the Building Regulations (Scotland).

# System Design

## Outlet Termination

Flue terminations for oil are subject to BS 6461 Part 2. Figure A illustrates recommendations for the most commonly encountered terminations.

Flue terminations for gas in domestic situations are governed by BS5440-1 2000

Section 4.2. Figure B illustrates recommendations for the most common terminations.

Adjacent taller structures may require increased height. The minimum flue projection through the roof is 600mm to the underside of the terminal.

**Fig B**

### BS5440-1 Gas Termination

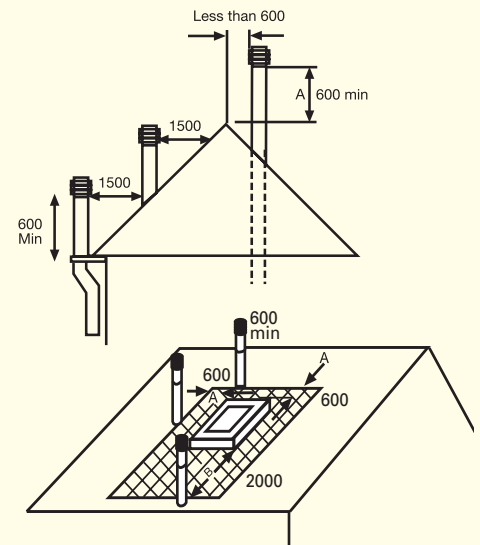

## Location of Outlet

**Fig A**

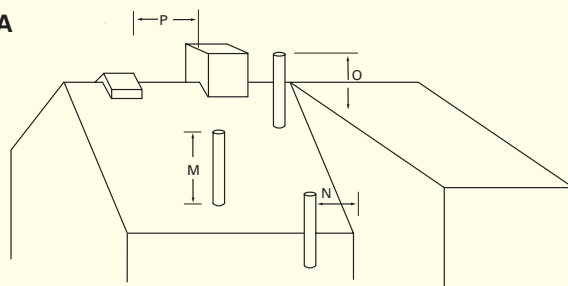

	Location of Outlet	Application: pressure jet burner	Application: vapourising burner
M	Above the highest point of an intersection with the roof	600mm	1000mm
N	From a vertical structure to the side of the terminal	750mm	2300mm
O	Above a vertical structure which is less than 750mm (pressure jet burner) or 2300mm (vapourising burner) horizontally from the side of the terminal	600mm	1000mm
P	From a ridge terminal to a vertical structure on the roof	1500mm	should not be used

**Fig C**

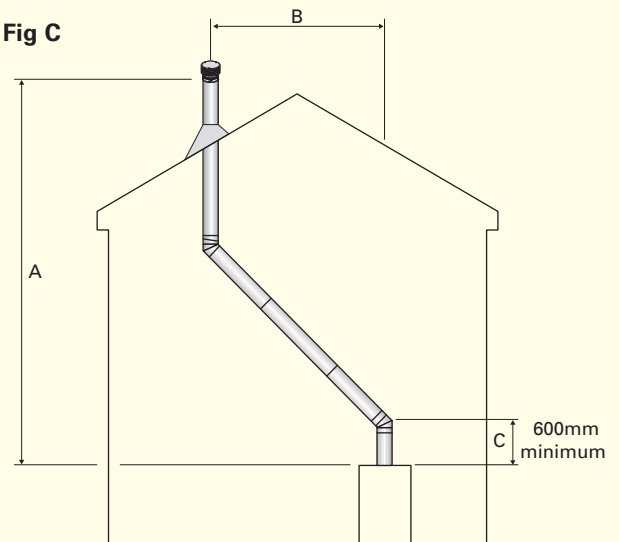

### Flue routing

Systems should be vertical as far as possible for most efficient evacuation and should not exceed 45° from the vertical, otherwise resistance to flue gas flow will result. Bends should be kept to a minimum and a vertical rise of 600mm minimum should be allowed for immediately above the appliance.

As a general rule, the vertical distance (A) between the appliance and the flue terminal should always be at least twice the horizontal distance (B) between the appliance and the terminal (see Fig C).

The K Vent range includes 30° and 45° fixed bends which can be used where the flue system needs to be offset e.g. to avoid trusses and terminate to a ridge terminal.

### Use of K Vent on condensing appliances

**K Vent is not suitable for this application.** Prima Plus and ICS Plus are the products in the Rite-Vent range specifically designed for or for condensing or pressurised applications.

# Dimensions

The internal and external dimensions of the flue are:

IntØ (mm)	100	125	150
ExtØ (mm)	127	152	178

## Component Ordering

When ordering, state the product code followed by the internal diameter, e.g. for a 125mm dia. 500mm long pipe, the full code would be 0205125.

## Starting Components

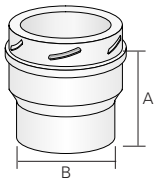

**Flue Block Adaptor** 0245

IntØ (mm)	100	125	
ExtØ (mm)	127	152	
A	95	95	
B	100	125	

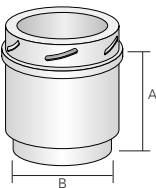

**Appliance Connector** 0246

IntØ (mm)	100	125	150
A	110	110	110
B	98	123	150

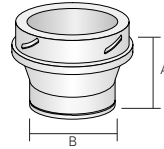

**Increaser Connector** 0247

IntØ (mm)	100	125	
A	66	66	
B	80	95	

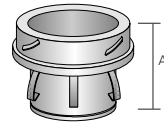

**Flex to KVent Conn.** 1278

IntØ (mm)	100	125	150
A	100	100	100



**KVent to Flex Conn.** 1279

IntØ (mm)	100	125	150
A	75	75	75

## Pipes

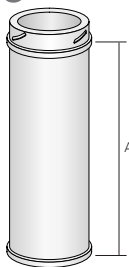

Code	0202	0205	0206
Nom length	1000	500	300
Effective length A	980	480	270



**Adjustable Pipe** 0208

IntØ (mm)	100	125	150
-----------	-----	-----	-----

Effective Length Range 40-245mm  
Slide over male of pipe below.  
Take out insulation strips as required.  
Tighten jubilee clip.  
Min. 40mm overlap.  
Do not use after bend or tee since insufficient overlap.

## Bends

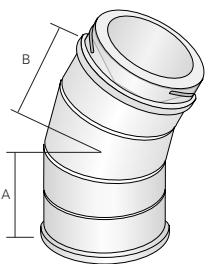

**30° Bend (Fixed)** 0219

IntØ (mm)	100	125	150
A	113	113	132
B	73	73	81

**45° Bend (Fixed)** 0217

IntØ (mm)	100	125	150
A	115	115	115
B	75	75	100

Lower segment rotates enabling exact alignment of system.

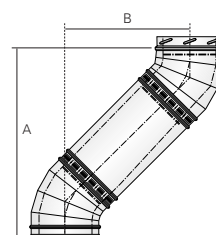

**30° Bends (Offset)**

Pipe Length		100	125	150
0	A	347	347	397
	B	93	93	107
300	A	581	581	631
	B	228	228	242
500	A	763	763	813
	B	333	333	346
1000	A	1196	1196	1246
	B	583	583	596

**45° Bends (Offset)**

Pipe Length		100	125	150
0	A	324	324	367
	B	134	134	152
300	A	515	515	558
	B	325	325	343
500	A	664	664	706
	B	474	474	491
1000	A	1017	1017	1060
	B	827	827	845

## Tees

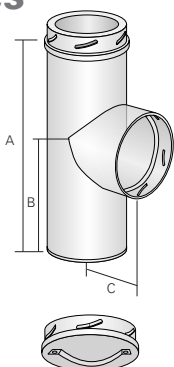

**90° Tee** 0220

IntØ (mm)	100	125	150
A	360	360	360
B	180	180	180
C	145	152	160

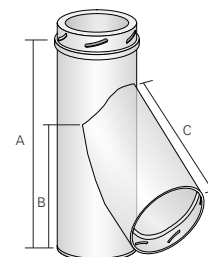

**135° Tee** 0221

IntØ (mm)	100	125	150
A	360	360	356
B	275	275	270
C	205	225	260

**Tee Cap** 0224

IntØ (mm)	100	125	150
-----------	-----	-----	-----



**Tee Cap & Drain** 0229

IntØ (mm)	100	125	150
-----------	-----	-----	-----

## Support Components

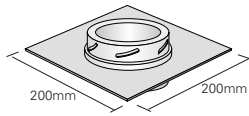

**Anchor Plate** 0289

IntØ (mm)	100	125	150
-----------	-----	-----	-----

Use to start from lintel or flue block

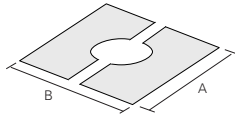

**Roof Plate (2 Piece)** 0167

IntØ (mm)	100	125	150
A	460	460	460
B	382	382	382

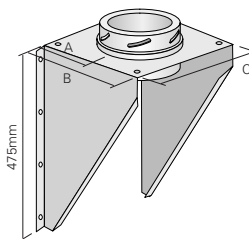

**Wall Support** 0287

IntØ (mm)	100	125	150
A	114	126	140
B	250	250	275
C	216	216	241

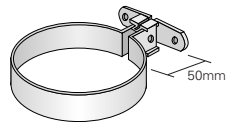

**Wallband 50mm ext** 0173

IntØ (mm)	100	125	150
-----------	-----	-----	-----

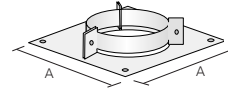

**Clamp Plate Support** 1368

IntØ (mm)	100	125	150
A	300	305	330

Max loading 6m

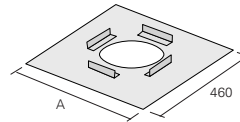

**Firestop Plate** 0166

IntØ (mm)	100	125	150
A	279	305	330

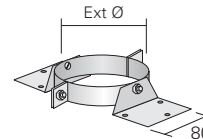

**Roof Support** 94640

IntØ (mm)	100	125	150
Ext.	125	150	180

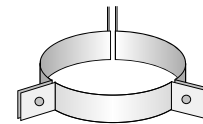

**Guy Wire Bracket** 95900

Int (mm)	100	125	150
Ext	125	150	180

Use Ext. when ordering

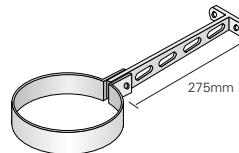

**Wallband 275mm adj** 0174

IntØ (mm)	100	125	150
-----------	-----	-----	-----

## Flashings / Terminals

Flashings supplied complete with storm collar and sealant.

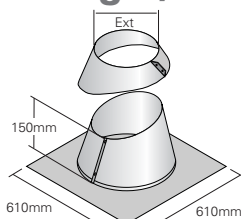

**Angled Flashing Kit 5°-45°** 95510

IntØ (mm)	100	125	150
Ext	125	150	180

Use Ext. Dia. no. when ordering

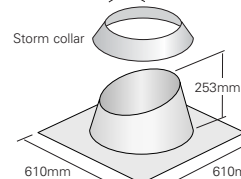

**Angled Flashing Kit 5°-30°** 0151

IntØ (mm)	100	125	150
-----------	-----	-----	-----

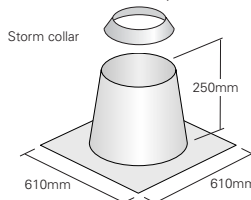

**Flat Flashing Kit** 0152

IntØ (mm)	100	125	150
-----------	-----	-----	-----

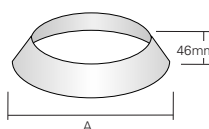

**Storm Collar** 0156

IntØ (mm)	100	125	150
A	220	248	270

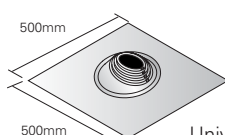

**Uniflash** 94540001

ExtØ (mm)	80-200
-----------	--------

Storm collar not required.  
Universal EPDM rubber/aluminium flashing.  
Pull the required diameter tab on the rubber seal.

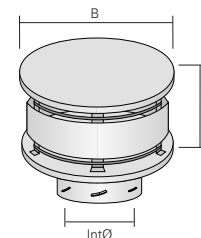

**Anti Splash / Anti Downdraught** 0128

IntØ (mm)	100	125	150
A	110	130	170
B	200	250	300

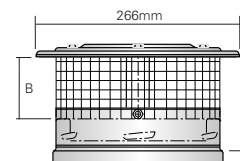

**Raincap** 0232 & 0233

	Code	A	B
Bolted Raincap	0232	180	152
Std. Raincap	0233	148	120

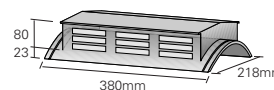

**Ridge Tile Top (Gas only)** 0142

IntØ (mm)	100	125
-----------	-----	-----

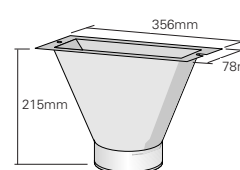

**Ridge Tile Adaptor (Stainless Steel)** 0235

IntØ (mm)	100	125
-----------	-----	-----

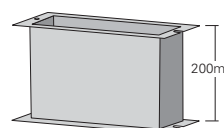

**RTA Extension Box (Stainless Steel)** 0236

IntØ (mm)	100	125
-----------	-----	-----

Use on steep roof pitch situations



# Installation

## Mandatory requirements

Connection to an appliance which is not connected to the fuel supply may be carried out by a competent person. However, connection to an appliance that is connected to the fuel supply **must** be carried out by a CORGI (gas) or OFTEC (oil) registered installer.

The flue system must be installed to comply with Building Regulations Document J (in England, Wales and Northern Ireland) for gas and kerosene appliances having a flue gas temperature of 250° max, and the Building Regulations for Scotland. In the U.K. the installation must also comply with BS7566 pts 1,2,3,4 for oil flues and BS5440 pt 1 : 2000, and IS813 domestic fuel installations in Ireland.

## Joining

All pipe lengths and flue gas carrying components are joined by a twist lock, bayonet system. The system should be installed with the visible male collar upwards, this is reaffirmed by the directional arrow pointing upwards, indicating the flow of the flue gases (see Fig 1).

There is no need need to tape the joints. No locking band is required.

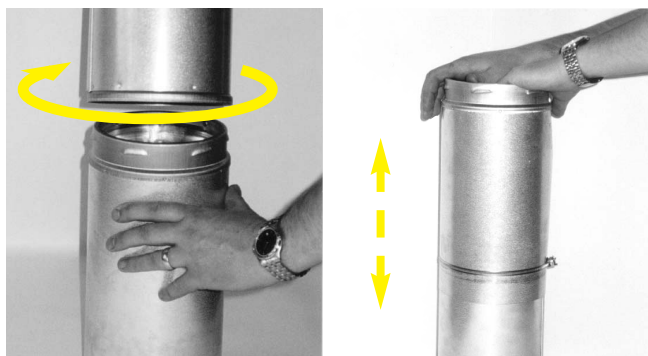

Fig 1

Fig 2

## Adjustable Length

Within the range is an adjustable length which is used to telescope over standard pipe lengths to provide the exact flue lengths required, removing insulation as necessary. It should not be used directly after a bend since there is insufficient overlap to ensure a sound joint. A clamp plate support or wall band must be used above an adjustable length as this component is not loadbearing (see Fig 2).

## Connection to Appliance/ Flueblock

Always use an appliance connector/ flueblock adaptor. Seal using fire rope and fire cement or high temperature sealant.

## Appliance Removal

Use of a pipe and an adjustable length immediately above the appliance enables removal of the appliance later without dismantling the full system.

## Painting of K Vent

If required to be painted, simply clean the surface with a solvent cleaner (White Spirit), apply a coat of primer and a top coat of high temperature paint e.g. enamel. Extreme care must be taken when cleaning with solvent to ensure that it does not come into contact with the insulation within the cavity.

## Recommended distances from combustibles

In accordance with the Building Regulations, a minimum distance of 50mm to combustible materials **must** be maintained. K Vent support components provide a 50mm clearance.

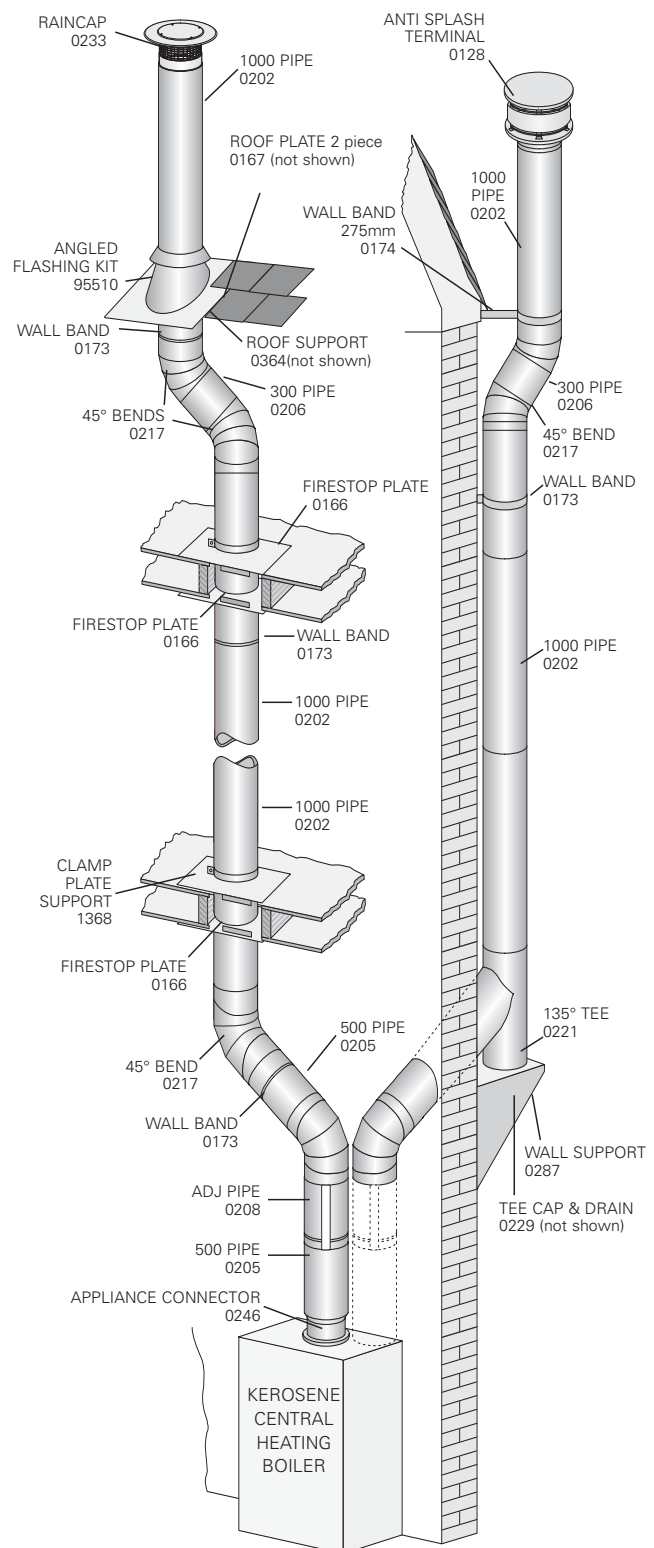

## Support components

The maximum height that can be supported using a wall support is 10m. The flue must also be supported every 3m using wallbands.

Wallbands and roof supports are not load bearing and provide lateral support only. The system should be braced using a roof support immediately below roof line.

Internal systems should be supported by using a clamp plate support fixed on top of the floor/ceiling joist. A Firestop plate is also required fixed to the ceiling below. The clamp plate and firestop have tags fixed to ensure 50mm distance to combustibles. In a normal house, when passing through the second floor the only requirement is two firestop plates because the system is adequately supported at first floor level.

Ensure that no joint occurs within the floor space. A roof plate (2 piece) should be used on the underside of roof trusses where the system is terminated via a flashing.

The maximum height unsupported above the roof line is 0.6m. Where a joint is above the roofline it should be determined that in extreme wind conditions this joint would not be over exerted. If there is any doubt then a guy wire should be used. Beyond this guy wires should be installed every metre.

### Connection to a ridge terminal

For kerosene appliances, a stainless steel ridge tile adaptor **must** be used and connection must **only** be made to a concrete or terracotta ridge terminal. A gasket (supplied on request) or mastic sealant must be used to provide a gas and condensate tight joint.

For gas appliances use Ridge Tile 0142 (page 5).

### Connection of K Vent to an existing chimney

K Vent is not for use as a chimney liner, however, it can be used to connect to and from a Wonderflex/Triplelock flexible flue liner which may be lining an existing chimney, when used on appliances described in previous section.

#### K VENT USED ON HIGH EFFICIENCY GAS FIRE FROM TOP OF FLUE BLOCKS TO RIDGE TERMINAL

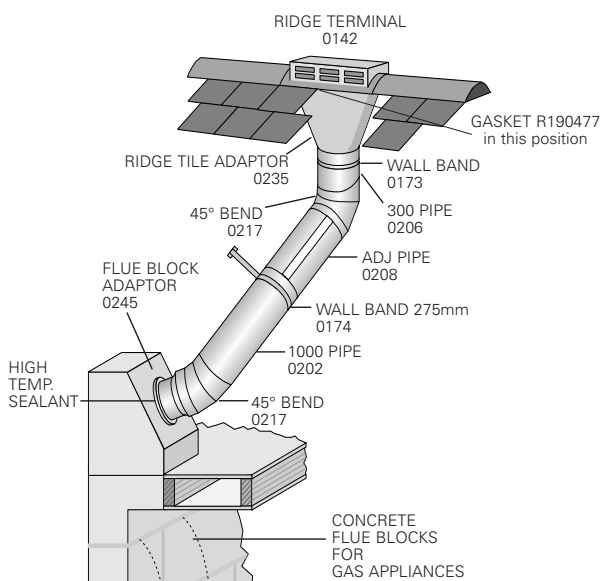

#### EXISTING CHIMNEY LINED WITH TRIPLELOCK/ WONDERFLEX AND CAVITY BACKFILLED AROUND LINER

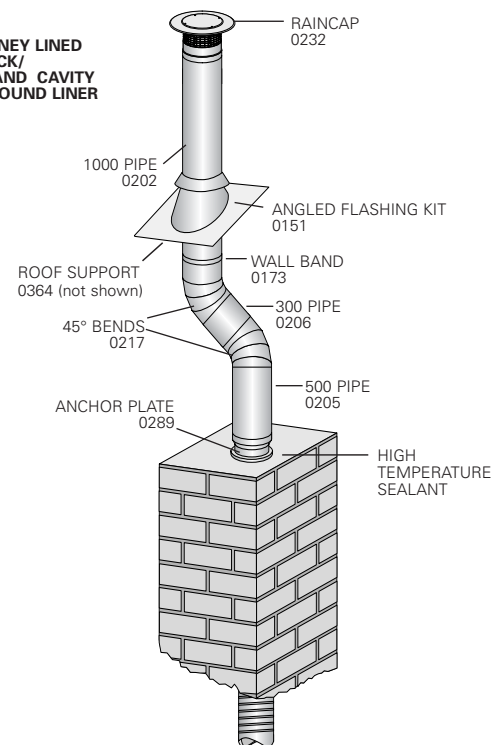

## After Installation

### Testing before use

This is done by means of a flue flow test as described in BS5440:Part 1-2000. It can be summarised as follows:- After a visual and physical check of the joints in the system, and ensuring an adequate air supply for combustion has been provided, close all doors and windows in the room in which the appliance is to be installed. It will be necessary to introduce heat to the flue system for a minimum of 10 mins. and possibly up to 30 mins. using a blow torch or similar. Position a smoke pellet (providing a performance of 5m<sup>3</sup> of smoke in 30 secs. burn time) at the intended position of the appliance. The test is satisfactory if there is no **significant** spillage from the appliance position, no seepage over the length of the system, and discharge only from the terminal. If these conditions are not met, the test has failed and all faults must be rectified and the system retested before connection of the appliance to the fuel supply. In the event of any further problems, reference to BS5440:Part 1-2000 must be made.

### Maintenance

It is essential that the flue way be kept clear at all times. The system should be checked regularly during the appliance maintenance (refer to appliance manufacturers instructions).



**INSTALLER HELPLINE**  
**+44 (0) 191 416 6666**

More information on [www.schiedelrite-vent.co.uk](http://www.schiedelrite-vent.co.uk)



### ■ K Vent

Twin wall insulated venting system for oil (28 sec) and gas appliances.  
Residential and small commercial applications.  
100-150mm internal diameters.  
Oil appliances up to 45kW output.  
Gas appliances up to 60kW input.  
Interfits with B Vent gas vent.

## Other products in the Schiedel Chimney Systems range



### ■ B Vent

Twin wall gas venting system.  
Residential & small commercial applications.  
100-150mm internal diameters.  
Gas appliances up to 60kW input.



### ■ ICS

Twin wall insulated chimney system for gas, oil, wood and multifuel appliances and open hearths  
Residential and commercial applications.  
80-705mm internal diameters.  
For atmospheric, condensing and pressure appliances.  
Wet or dry flue and chimney operating conditions.



### ■ ICID

Quick assembly twin wall insulated chimney system for gas, oil, wood and multifuel appliances and open hearths.  
Residential and small commercial applications.  
125-300mm internal diameters.  
Quick assembly twist-lock joint.  
For atmospheric appliances and Class 1 chimneys.



### ■ Prima

Single wall stainless steel flue system.  
80-755mm diameter range.  
Prima Plus 1mm for domestic multi fuel stoves.  
Prima Plus for large residential and commercial condensing gas and oil appliances and chimney relining.



### ■ Flue Boxes

For installing gas fires and back boilers.  
Connection to single and twin skin flexible liners, B Vent, ICS or ICID.  
Fast fix spigot for flex connection avoids much of the building work.  
Single skin and twin skin air-insulated versions.

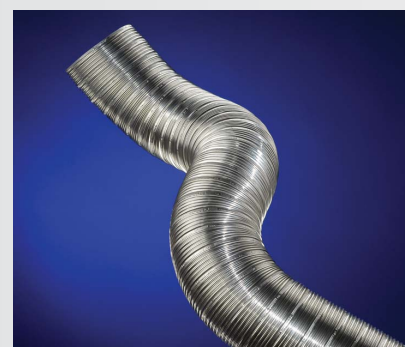

### ■ Flexible Liners

For relining existing chimneys to take gas, oil, wood, multifuel appliances and open fires.  
Single skin Wonderflex and Triplelock for gas and oil (28 sec).  
Twin skin Tecnoflex Plus for oil, wood, multifuel and open fires.  
80-300mm diameter range.



#### Schiedel Chimney Systems

Crowther Estate  
Washington  
Tyne & Wear NE38 0AQ  
Tel. +44 (0)191 416 1150  
Fax. +44 (0)191 415 1263  
sales@schiedel.co.uk  
www.schiedel.co.uk

#### Schiedel Chimney Systems

Carrickmacross  
Co. Monaghan  
Ireland  
Tel. +353 (0)42 966 1256  
Fax. +353 (0)42 966 2494  
office@schiedel.ie  
www.schiedel.ie