

SCHIEDEL

RITE-VENT



ICS

**80 - 250mm internal diameter
Twin wall insulated chimney system
for gas, oil, wood and multi-fuel
applications.**

- Stoves and open fires
- Residential and small commercial applications
(See Commercial brochure for larger diameters)
- Atmospheric and condensing applications
- Oil and gas appliances up to 150kW
- Available in stainless steel or paint finish

NEW!
COMPONENTS



ICS 80/250 LIT DOC/CP3/50 January 2011

MONIER

Application

ICS is a twin wall insulated chimney system for use on open and closed stoves, open fires, residential and small commercial multi fuel appliances, with continuous operating temperatures up to 450°C and short firing up to 550°C.

ICS Plus ICS is converted into ICS Plus by adding a lip seal to each component with a male form on the liner (see ICS Plus diagram below). This creates a twin wall insulated chimney system designed for the new generation of condensing gas and oil appliances, with continuous operating temperatures up to 200°C, short firing up to 250°C, and positive pressure up to 200Pa at the appliance outlet.

Other ICS Ranges For larger commercial and industrial applications of ICS in diameters 300mm to 700mm please refer to our separate sales brochure. For higher pressure applications up to 5000Pa e.g. generators, combustion and process equipment, please see the commercial brochure.

Product Description

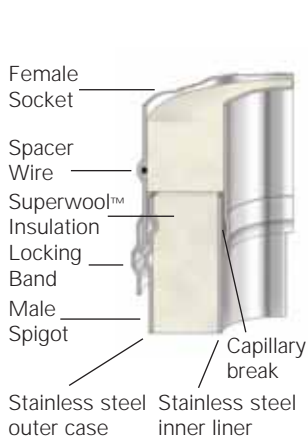

ICS

- Simple push-fit jointing system, secured by locking band.
- Advanced corrosion resistant design and construction uses laser welded 316L stainless steel inner liners and stainless steel case. The only stainless steel system to have passed the internationally recognised GASTEC corrosion test.
- The jointing system increases rigidity and ensures easy draindown of any condensate in the flue.
- Capillary break prevents moisture being drawn through the joint.
- Because of the sleeve joint, the insulation in the pipe is able to be continuous over the length of the system ensuring no hot spots.
- The 25mm high efficiency Superwool™ blanket maintains flue gas temperature, maximising efficiency, improving flue draught on start up and minimises condensation.
- Low external case temperature.
- The assembly method allows the inner liner to expand and contract with temperature at the female end. The flue can withstand the temperatures of a soot fire without losing the integrity of the joints.
- Generous lead-in edges on liner and case for ease of jointing.



ICS Plus

ICS Plus for condensing appliances is created by adding a lip seal gasket that can maintain positive pressure up to 200Pa. All the design and construction benefits of ICS apply.



ICS is CE Certified to EN1856-1 TUV 0036 CPD 9195001 with designations:

High Temperature Applications		Low Temperature Applications
T450 N1 W V2 L50050 G60 T450 N1 D V3 L50050 G60 60mm Distance to combustibles in a combustible shaft*	T450 N1 W V2 L50050 G50 T450 N1 D V3 L50050 G50 50mm Distance to combustibles in a non combustible shaft or in free air*	T200 P1 W V2 L50050 O00 Zero distance to combustibles*

* For full information please see p.13 - Distance to combustibles section

- Kitemarked to BS4543 Parts 2 & 3 for gas, oil and solid fuel (Ø 80mm - 200mm inclusive)
- Manufactured under a Quality Management Scheme approved to BS EN ISO 9001: 2008
- 4 Hour Fire Rating to BS476 Part 20
- Certified for corrosion resistance on gas, oil and solid fuel by Gastec, MPA and TuV
- HETAS listed for use on solid fuel applications.

Corrosion Resistance

Chimneys are subject to significant corrosion attack by flue gas condensates, particularly from solid fuel and condensing appliances. ICS is specifically designed and manufactured to resist this corrosion. It is the only stainless steel chimney system in the world to have passed the internationally recognised Gastec corrosion test.

Flue Size Selection Guide

The chimney size should be as recommended by the appliance manufacturer. Where there is a requirement for a flue diameter smaller than the appliance spigot, then the operational requirements of the appliance and the configuration of the flue must satisfy the flue sizing requirements of 13384-1 (single appliances) and 13384-2 (multi appliances). For more information contact the installer helpline (0191 416 6666). The information and sizes below are provided as a nominal guide only. Flue sizing for appliances, particularly commercial/industrial applications, will vary depending on siting details and appliance manufacturer's instructions and design criteria. These will override the sizing guide and reference must be made to appliance manufacture. For Inglenook and non-standard openings, the diameter of the flue must be at least 15% of the cross sectional area of the fireplace opening.

	80 mm	100 mm	130 mm	150 mm	180 - 250mm
Gas - Atmospheric Boiler					
Input up to 25kW		•			
Input 25kW to 40kW			•		
Input 40kW to 60kW				•	
Gas - Commercial/Ind. Boiler					
Input 50kW to 70kW					•2
Gas Fires					
'Radiant' to BS7977-1 2002			•		
'Inset' to BS7977-1 2002			•1		•1
'Backboiler' to BS7977-2 2003			•		
Gas Water Heaters					
Input up to 25kW	•	•			
Input 25kW to 55kW			•		
Input 55kW to 60kW				•	
Input over to 60kW					•2
Gas Warm Air Unit					
Input up to 18kW		•			
Input 18kW to 35kW			•		
Input 35kW to 60kW				•	
Input over to 60kW					•2
Gas Stove/Cooker		•2	•2	•2	
Kerosene (28sec Class C2)					
Heating Boiler					
Output up to 25kW		•			
Output 25kW to 45kW			•		
Output 45kW to 70kW				•	
Kerosene Stove/Cooker		•3	•3	•3	
Kerosene Water Heater					
Input up to 41kW				•	
Kerosene Visual Effect Stove					
Output up to 17kW		•3	•3		

Technical Data

	ICS	ICS Plus
Fuel	Gas, oil, wood, coal	Gas, oil
Firing Temp	450° C	200° C
Short Firing Temp	550° C	250° C
Thermal Shock	1000° C	-
Mode of Operation	Zero & negative pressure	Positive pressure
Pressure Capabilities	40Pa	200Pa
Fire Rating	4 Hour Fire Rating to BS 476 Part 20	
Outer Case (Standard)	Stainless Steel	
Outer Case (Option)	Galvanised	
Outer Case Thickness	0.6mm	
Seam	Laser or inert gas welded	
Liner	316L : 1.4404 : X2CrNiMo 17-12-2	
Liner Thickness (mm)	0.5mm	
Seam	Laser or inert gas welded	
Insulation	High performance mineral fibre	
Insulation Thickness	25mm	
Average Thermal Resistance (200°C)	0.508m ² kW	

	100 mm	130 mm	150 mm	180 mm	200 mm	230 mm	250 mm
Gas Boiler - Forced Draught							
Input up to 25kW	•						
Input 25kW to 45kW		•					
Input 45kW to 50kW			•				
Input 50kW to 75kW				•			
Input 75kW to 100kW					•		
Input over to 100kW						•	•2
Gas Fires							
'Inset' to BS7977-1 2002				•1			
'Decorative' BSEN 509:2000				•			
Gas Oil (35sec Class D)							
Heating Boiler							
Output up to 25kW	•						
Output 25kW to 45kW		•					
Output 45kW to 70kW			•				
Output 70kW to 100kW				•			
Output over 100kW					•3	•3	•3
Solid Fuel							
Heating Boiler							
Input up to 20kW			•S	•SC			
Input 20kW to 30kW				•S	•SC	•SC	
Input 30kW to 60kW					•SC	•SC	•SC
Open Fires (standard opening)							
500mm x 550mm					• 200min	•	•
Avant Garde Feature Open Fires							•4
Room Heaters			•S				
Wood burning stoves and cookers							
Use only seasoned wood.			•1	•	•	•	•
Inglenook / non-standard opening							
Flue size dependant on cross-sectional area of fireplace opening.						• 230min	•

Notes: 1 Subject to appliance manufacturer's testing criteria. 2 Subject to manufacturer's input rating and chimney height. 3 Subject to manufacturer's output rating and chimney height. 4 Min 300mm depending on opening, chimney size and height. S Smokeless fuel only. SC Smokeless fuel or coal.

System Design

Outlet Siting

Flue terminations for solid fuel & oil are subject to EN15287-1 2007. Figure A illustrates recommendations for the most commonly encountered outlet terminations. Flue terminations for gas in domestic situations are governed by the BS5440-1 2000 Section 4.2. Figure B illustrates recommendations for the most common siting situations encountered. Adjacent taller structures may require increased height. The minimum flue projection through the roof is 600mm to the underside of the terminal.

Location of outlet

Figure A

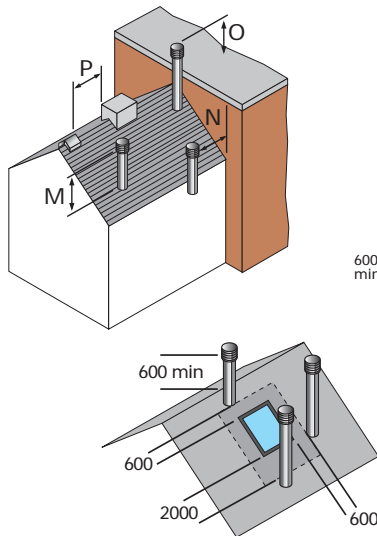
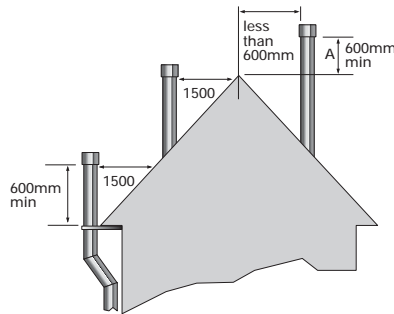

Figure B
BS 5440-1
Gas Termination



	Location of outlet	Pressure jet burner	Vapourising burner	Solid fuel
M	Above the highest point of an intersection with the roof	600mm	1000mm	1000mm
N	From a structure to the side of the terminal	750mm	2300mm	2300mm
O	Above a vertical structure which is less than 750mm (pressure jet burner) or 2300mm (vapourising burner) horizontally from the side of the terminal	600mm	1000mm	1000mm
P	From a ridge to a vertical structure on the roof	1500mm	should not be used	should not be used

Flue Routing

The chimney should remain as straight as possible through its vertical run to assist flow. Should it be necessary to offset a chimney run the following guidelines should be adhered to:

It is recommended that a vertical rise of 600mm should be allowed immediately above the appliance before any change of direction.

Within a system, on all fuels, there should be no more than 4 changes of direction of maximum 45°.

90° Factory made bends or tees within the system may be treated as being equal to two 45° bends (see Document J of the Building Regulations issued October 1st 2010).

Terminal Types

On solid fuel appliances, an open termination is normally recommended. However in certain conditions, rain caps or anti-downdraught terminals may be used.

Rain caps and anti-downdraught terminals are available in two versions, with anti bird mesh and without mesh. Where a terminal with mesh is used, there is a risk of soot build up, and therefore regular cleaning is required to avoid blockage, particularly when using oil or solid fuel.

Provision for sweeping, cleaning and maintenance

Provision should be made for inspecting and cleaning the chimney. To aid cleaning, sufficient distance should be left between changes of direction to permit the safe passage of cleaning brushes within the system. This is particularly important on solid fuel applications. It is recommended that chimneys serving solid fuel appliances be swept as frequently as necessary but at least twice a year. Choose an access component suitable for your installation unless cleaning/inspection can be done through the appliance.

Room Ventilation

The room carrying the appliance should have an air vent either direct to an external air source or vented into a room that has an external vent direct to an air source. This is required to provide adequate air supply to allow the appliance and flue to operate efficiently. These requirements are specified in the Building Regulations (Document J) also by CIBSE and BS5440.

Commercial Installations

Schiedel Rite-Vent can provide a full design & flue sizing advice service for commercial installations. The ICS range contains all the required components for commercial use including time-saving telescopic header tees for increasingly popular multi-boiler installations.

Typical condensing boiler installation using ICS Plus

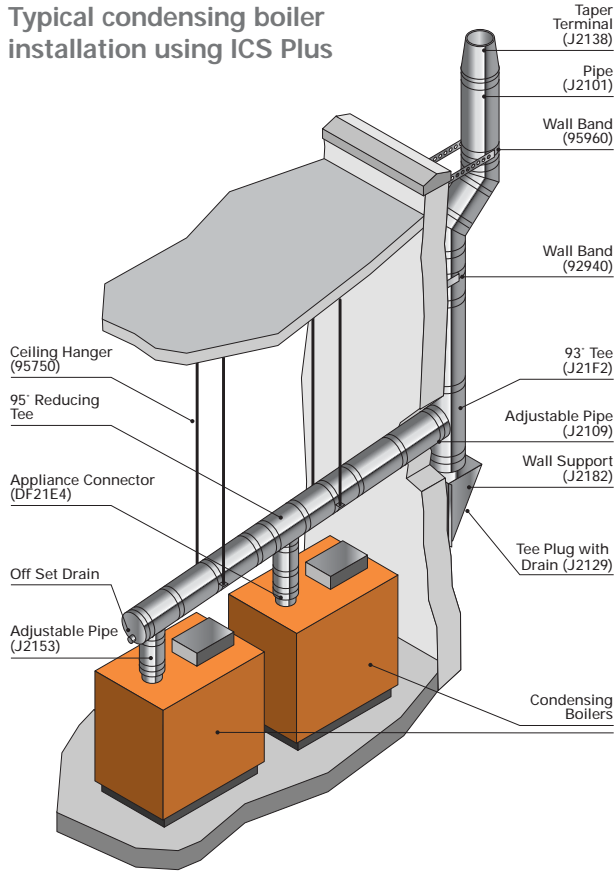

Provision for condensate disposal

(subject to appliance manufacturer recommendations)

Normally solid fuel and atmospheric gas and oil appliances will not need a drain unless rain ingress is significant. Most condensing appliances however need provision for drainage. As a rule of thumb a condensing boiler produces 1 to 1.5 litres of condensate per hour per 10kW of input.

This is a significant amount of acidic liquid which must be drained from the system. Choose appropriate flue drainage components, normally fitted at the base of the stack and close to the appliance outlet.

A 3° slope on horizontal runs is advised, using the appropriate 87° bend and 93° tee.

Typical pressure jet boiler Installation using ICS

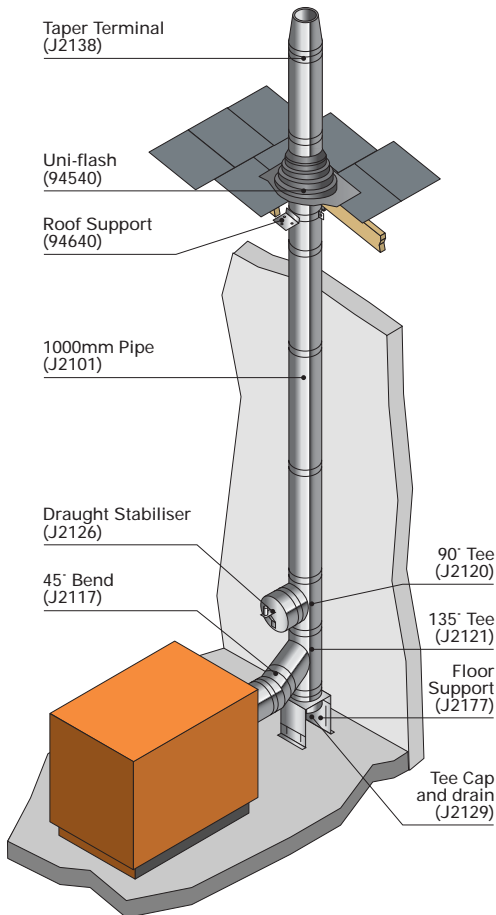

Typical chimney extension installation using ICS

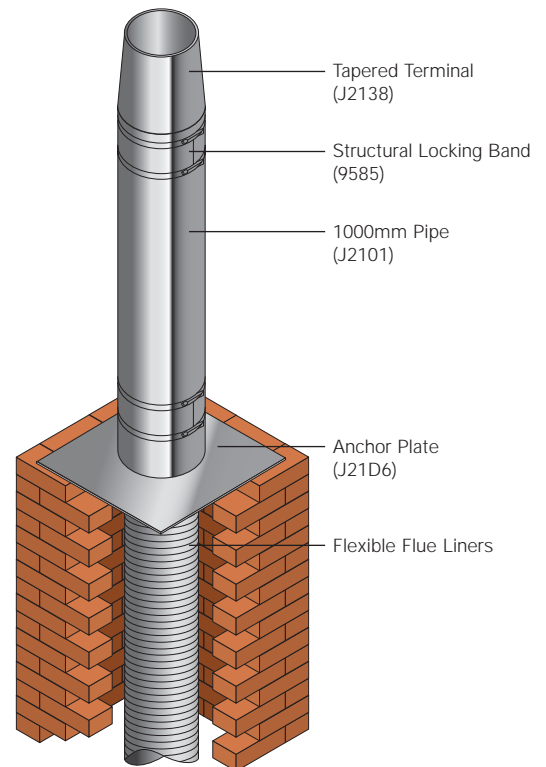

Dimensions

The dimensions of the flue are:

Int Ø mm	80	100	130	150	180	200	230	250
Ext Ø mm	130	150	180	200	230	250	280	300

Product Ordering

To identify fully the component required it is necessary to state the product code followed by diameter as follows.

- Quote the product code followed by the internal diameter. Eg. for a 150mm Int Ø ICS 45° bend, the full code would be J2117150.
- Codes starting with a number 9 are universal accessories common to a number of Schiedel Rite-Vent ranges and therefore require definition of the external diameter. eg. to specify a wall band 50mm to suit a 150mm Int Ø system, the external diameter is 200mm therefore the full code is 92940200.

ICS Plus

ICS components are converted to ICS Plus components by adding a gasket to each component. When ordering ICS Plus, order the internal diameter sized gasket for each component. Some components are specifically manufactured for condensing appliances. The code for these are prefixed with 'DF'.

Finish

Paint ICS & ICS Plus can be supplied painted in any RAL colour (additional costs apply).

Starting Components

ICS J2147
ICS Plus DF21E4

Appliance Connector

Int Ø	80	100	130	150	180	200	230	250
-------	----	-----	-----	-----	-----	-----	-----	-----

ICS S068

**Connector
Prima Plus to ICS**

Int Ø	80	100	130	150	180	200	230	250
-------	----	-----	-----	-----	-----	-----	-----	-----

ICS J2169

Starting Connector

Int Ø	80	100	130	150	180	200	230	250
-------	----	-----	-----	-----	-----	-----	-----	-----

ICS J2178

**Adaptor
- ICS to Prima Plus**

Int Ø	80	100	130	150	180	200	230	250
-------	----	-----	-----	-----	-----	-----	-----	-----

ICS J2171

Increaser

Int Ø	80	100	130	150	180	200	230
A	100	130	150	180	200	230	250
B	150	180	200	230	250	280	300

ICS J2179

**Adaptor
- ICS to Tecnoflex Plus**

Int Ø	80	100	130	150	180	200	230	250
-------	----	-----	-----	-----	-----	-----	-----	-----

ICS J21D6

Anchor Plate

Int Ø	80	100	130	130	150	180	200	230	250
A	250	270	300	300	320	350	370	400	420
B	220	240	270	270	290	320	340	370	390
C Ø	80	100	125	130	150	180	200	230	250

Order code for Increaser Anchor Plate from 125 to 130mm is J21D6125130

ICS J2175

Stove Starter Pipe

Int Ø	130	150	180	200
Ext Ø	180	200	230	250
A Ø	125	150	175	200

Pipes

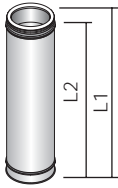

Int Ø	80	100	130	150	180	200	230	250
Part ref. ICS	J2101	J2102	J2103	J2104				
Length L1	1000mm	500mm	250mm	195mm				
Length L2	955mm	455mm	205mm	150mm				

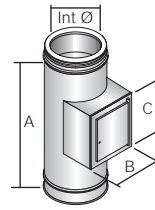

Inspection Length - ICS ICS J2111

Int Ø	80	100	130	150	180	200	230	250
A	292	292	292	292	292	292	411	411
B	114	114	114	114	114	114	202	202
C	173	173	173	173	173	173	292	292

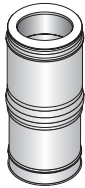

Adjustable Pipe

Int Ø	80	100	130	150	180	200	230	250
Part ref. ICS	J2152	J2109	J2153	J2154				
Length	195 - 250mm	270 - 375mm	375 - 585mm	585 - 1005mm				

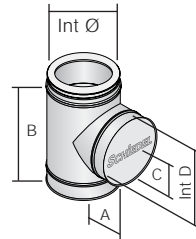

Inspection Tees - ICS Plus ICS Plus DF21E6

Int Ø	80	100	130	150	180	200	230	250
A	125	135	150	160	175	185	180	210
B	255	275	305	325	355	375	375	375
C	145	155	170	180	195	205	205	205
Int D	130	150	180	200	230	250	250	250

To change into ICS Plus a total of 3 gaskets are required on adjustable pipes.

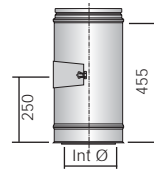

Inspection Pipe - ICS ICS J21A4

Int Ø	80	100	130	150	180	200	230	250
-------	----	-----	-----	-----	-----	-----	-----	-----



Locking Band ICS J2183

Int Ø	80	100	130	150	180	200	230	250
-------	----	-----	-----	-----	-----	-----	-----	-----

Supplied with components as standard with female form.

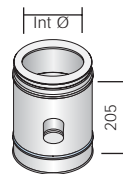

Measure Pipe ICS J2195

Int Ø	80	100	130	150	180	200	230	250
-------	----	-----	-----	-----	-----	-----	-----	-----

NEW!
COMPONENT

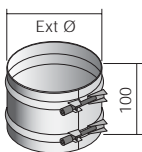

Structural Locking Band 95850

Int Ø	80	100	130	150	180	200	230	250
Ext Ø	130	150	180	200	230	250	280	300

For static loading information please see p.15

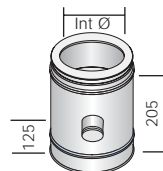

Vertical Drain Pipe ICS J21A5

Int Ø	80	100	130	150	180	200	230	250
-------	----	-----	-----	-----	-----	-----	-----	-----

Gasket to convert ICS to ICS Plus

Fit into the groove form on all female socket (liners) and into grooves on adjustable pipe liner.



Silicone Gasket (Gas Only) S000

Int Ø	80	100	130	150	180	200	230	250
-------	----	-----	-----	-----	-----	-----	-----	-----

For use on condensing gas applications with a pressure rating of up to 200Pa.



Viton Gasket (Gas & Oil) V000

Int Ø	80	100	130	150	180	200	230	250
-------	----	-----	-----	-----	-----	-----	-----	-----

For use on condensing gas and oil applications with a pressure rating of up to 200Pa.

Bends

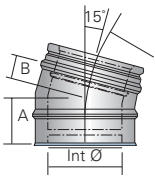

15° Bend ICS J2118

Int Ø	80	100	130	150	180	200	230	250
A	95	95	95	95	100	100	100	105
B	55	55	55	55	60	60	60	65

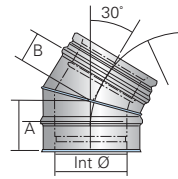

30° Bend ICS J2119

Int Ø	80	100	130	150	180	200	230	250
A	95	100	108	110	115	120	120	125
B	55	60	68	70	75	80	80	85

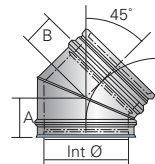

45° Bend ICS J2117

Int Ø	80	100	130	150	180	200	230	250
A	110	115	120	125	130	135	145	145
B	70	75	80	85	90	95	105	105

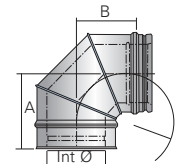

90° Bend ICS J2115

Int Ø	80	100	130	150	180	200	230	250
A	168	176	192	201	216	228	244	252
B	132	140	156	165	180	192	208	216

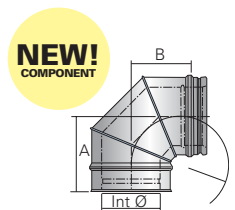

87° Bend ICS J21F3

Int Ø	80	100	130	150	180	200	230	250
A	166	173	189	198	213	225	239	248
B	130	137	153	162	177	189	203	212

Offsets (made by assembling 2 bends)

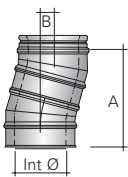

Offsets for Double 15° Bend

Int Ø	80	100	130	150	180	200	230	250
A	295	295	295	295	315	315	315	334
B	39	39	39	39	41	41	41	44

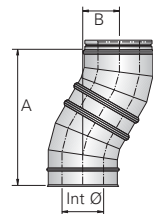

Offsets for Double 30° Bend

Int Ø	80	100	130	150	180	200	230	250
A	280	299	327	336	355	373	373	392
B	75	80	88	90	95	100	100	105

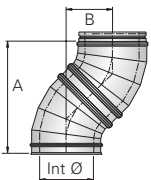

Offsets for Double 45° Bend

Int Ø	80	100	130	150	180	200	230	250
A	307	324	341	358	376	393	427	427
B	127	134	141	148	156	163	177	177

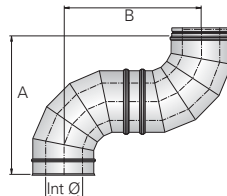

Offsets for Double 90° Bend

Int Ø	80	100	130	150	180	200	230	250
A	300	316	348	366	396	420	452	468
B	300	316	348	366	396	420	452	468

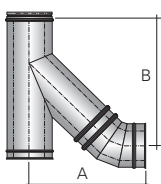

Offsets for 135° Tee and 45° Bend

Int Ø	80	100	130	150	180	200	230	250
A	343	370	437	445	452	496	523	537
B	305	324	404	406	415	473	475	499

Typical Offsets

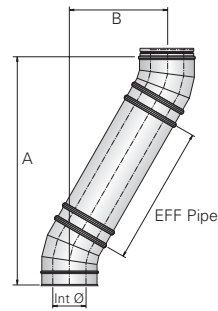
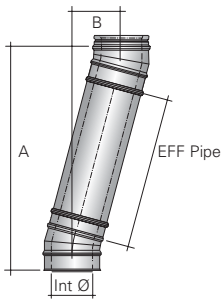

Double 15° Bend C/W Pipe Length

Int Ø mm		80	100	130	150	180	200	230	250
955 EFF Pipe	A	1218	1218	1218	1218	1238	1238	1238	1257
	B	286	286	286	286	288	288	288	291
455 EFF Pipe	A	735	735	735	735	755	755	755	774
	B	157	157	157	157	159	159	159	162
205 EFF Pipe	A	493	493	493	493	513	513	513	532
	B	92	92	92	92	94	94	94	97
150 EFF Pipe	A	445	445	445	445	465	465	465	484
	B	79	79	79	79	81	81	81	84

Double 30° Bend C/W Pipe Length

Int Ø mm		80	100	130	150	180	200	230	250
955 EFF Pipe	A	1107	1126	1154	1163	1182	1200	1200	1219
	B	553	558	566	568	573	578	578	583
455 EFF Pipe	A	674	693	721	709	765	765	784	784
	B	303	308	316	318	323	328	328	333
205 EFF Pipe	A	458	477	505	514	533	551	551	570
	B	178	183	191	193	198	203	203	208
150 EFF Pipe	A	414	433	461	470	489	507	507	526
	B	153	158	166	168	173	178	178	183

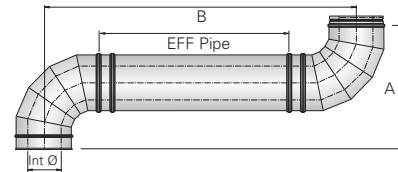
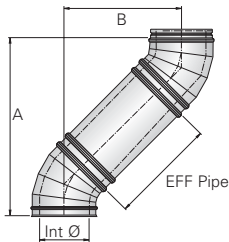

Double 45° Bend C/W Pipe Length

Int Ø mm		80	100	130	150	180	200	230	250
955 EFF Pipe	A	982	999	1016	1033	1051	1068	1102	1102
	B	802	809	816	823	831	838	852	852
455 EFF Pipe	A	629	646	663	680	698	715	749	749
	B	449	456	463	470	478	485	499	499
205 EFF Pipe	A	452	469	486	503	521	538	572	572
	B	272	279	286	293	301	308	322	322
150 EFF Pipe	A	417	434	451	468	486	503	537	537
	B	237	244	251	258	266	273	287	287

Double 90° Bend C/W Pipe Length

Int Ø mm		80	100	130	150	180	200	230	250
955 EFF Pipe	A	296	315	345	366	415	414	445	464
	B	1251	1270	1300	1321	1370	1369	1400	1419
455 EFF Pipe	A	296	315	345	366	415	414	445	464
	B	751	770	800	821	870	869	900	919
205 EFF Pipe	A	296	315	345	366	415	414	445	464
	B	501	520	550	571	620	619	650	669
150 EFF Pipe	A	296	316	345	366	415	414	445	464
	B	446	466	495	516	565	564	595	614

Tees

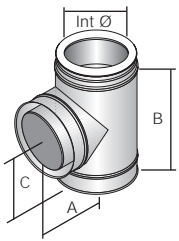

90° Tee ICS J2120

Int Ø	80	100	130	150	180	200	230	250
A	145	155	170	180	195	205	220	230
B	250	270	305	325	355	375	405	425
C	145	155	170	180	195	205	220	230

To change into ICS Plus a total of 2 gaskets are required on tee sections.

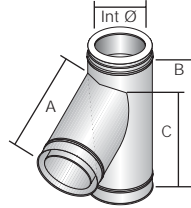

135° Tee ICS J2121 ICS Plus DF2121

Int Ø	80	100	130	150	180	200	230	250
A	238	262	298	322	358	382	419	443
B	299	327	375	403	445	474	516	544
C	238	262	298	322	358	382	419	443

To change into ICS Plus a total of 2 gaskets are required on tee sections.

NEW!
COMPONENT

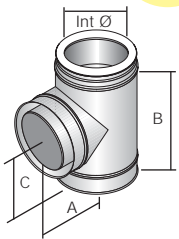

93° Tee ICS Plus J21F2

Int Ø	80	100	130	150	180	200	230	250
A	151	166	178	189	206	216	233	257
B	151	162	178	189	206	216	233	244
C	249	278	309	329	359	379	405	455

To change into ICS Plus a total of 2 gaskets are required on tee sections.

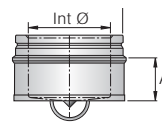

Tee Plug ICS J2125

Int Ø	80	100	130	150	180	200	230	250
A	35	32	38	41	44	44	48	48

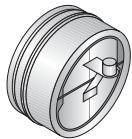

Draught Stabiliser Section ICS J2126

Int Ø	80	100	130	150	180	200	230	250
-------	----	-----	-----	-----	-----	-----	-----	-----

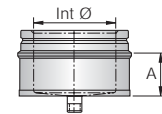

Tee Plug with Drain ICS J2129

Int Ø	80	100	130	150	180	200	230	250
A	35	32	38	41	44	44	48	48

Firestop Components

NEW!
COMPONENT

Round Ventilated Firestop Plates - Combustible Floor
1 Piece - 9423*
2 Piece - 9424*

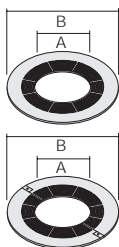

Int Ø	80	100	130	150	180	200	230	250
Ext Ø	130	150	180	200	230	250	280	300
A	133	153	183	203	233	253	283	303
B	330	350	380	400	430	450	480	500

Codes and Finish Options:
Plain Galvanised Steel 9423PO + Ext Ø
Black RAL 9005 (Matt) 9423BO + Ext Ø
White RAL 9016 (Matt) 9423W0 + Ext Ø

NEW!
COMPONENT

Ventilated Support Plate Rectangular Ventilated Firestop Plate - Combustible Floor
2 Piece - 95260
2 Piece - 94250

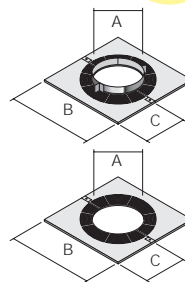

Int Ø	80	100	130	150	180	200	230	250
Ext Ø	130	150	180	200	230	250	280	300
A	133	153	183	203	233	253	283	303
B	330	350	380	400	430	450	480	500
C	165	175	190	200	215	225	240	250

Firestop Plate - Non Combustible Floor 94670

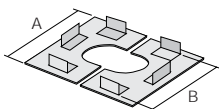

Int Ø	80	100	130	150	180	200	230	250
Ext Ø	130	150	180	200	230	250	280	300
A	300	300	330	350	380	400	430	450
B	230	250	280	300	330	350	380	400

Support Plate - Non Combustible Floor 95680

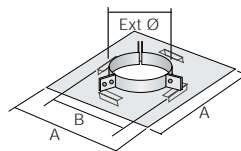

Int Ø	80	100	130	150	180	200	230	250
Ext Ø	130	150	180	200	230	250	280	300
A	300	300	330	350	380	400	430	450
B	230	250	280	300	330	350	380	400

Support Components

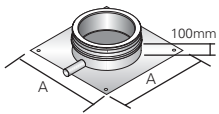

Base Support Plate with Drain ICS J2191

Int Ø	80	100	130	150	180	200	230	250
A	230	250	280	300	330	350	380	400

NEW!
COMPONENT

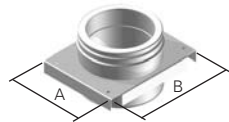

Adjustable Top Plate J21D3

Int Ø	80	100	130	150	180	200	230	250
Ext Ø	130	150	180	200	230	250	280	300
A	188	208	238	258	278	285	315	335
B	256	276	306	326	356	353	383	403

NEW!
COMPONENT

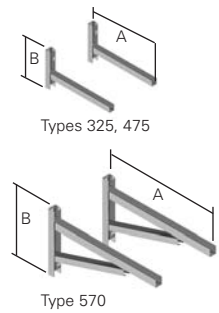

Cantilever Support
Type 325 - 95420001
Type 475 - 95420002
Type 570 - 95420003

Type	325	475	570
Ø Range	80 - 150	80 - 300	80 - 400
A	325	475	570
B	242	242	330

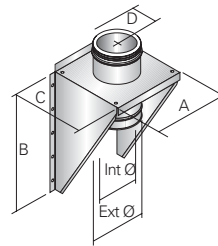

Wall Support J2182

Int Ø	80	100	130	150	180	200	230	250
Ext Ø	130	150	180	200	230	250	280	300
A	200	220	250	270	300	320	350	370
B	470	470	470	470	470	470	470	470
C	230	250	280	300	330	350	380	400
D	115	125	140	150	165	175	190	200

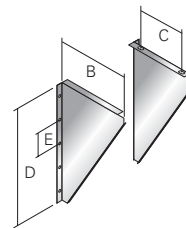

Wall Support Side Plates J21D2

Int Ø	80	100	130	150	180	200	230	250
B	215	235	265	285	315	335	365	385
C	145	165	195	215	245	265	295	315
D	470	470	470	470	470	470	470	470
E	100	100	100	100	100	100	100	100

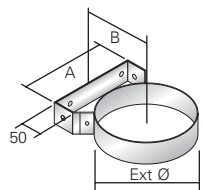

Wall Band (50mm) 92940

Int Ø	80	100	130	150	180	200	230	250
Ext Ø	130	150	180	200	230	250	280	300
A	128	148	178	198	228	248	278	298
B	115	125	140	150	165	175	190	200

NEW!
COMPONENT

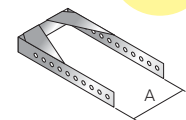

Adjustable Back Bracket for Wall Band 60 - 300mm 95950

Int Ø	80	100	130	150	180	200	230	250
Ext Ø	130	150	180	200	230	250	280	300
A	131	151	181	201	231	251	281	301

NEW!
COMPONENT

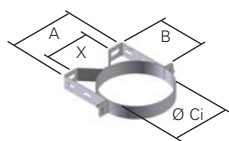

Structural Wall Band (50mm) 95430

Int Ø	80	100	130	150	180	200	230	250
Ext Ø	130	150	180	200	230	250	280	300
A	138	158	188	208	238	258	288	308
B	116	126	141	151	166	176	191	201
Ø Ci	131	151	181	201	231	251	281	301
X	100	120	150	170	200	220	250	270

NEW!
COMPONENT

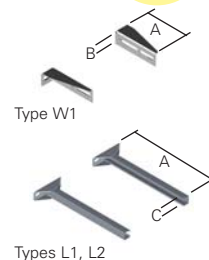

Structural Wall Band Extension
W1 - 95440001
L1 - 95440004
L2 - 95440005

Type	W1	L1	L2
Adj.	55-100	100-250	100-440
A	130	300	450
B	36	-	-
C	-	32	32

Support Components Continued

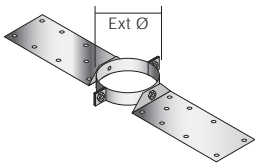

Roof Support 94640

Int Ø	80	100	130	150	180	200	230	250
Ext Ø	130	150	180	200	230	250	280	300

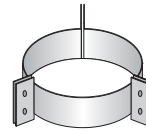

Guy Wire Bracket 95900

Int Ø	80	100	130	150	180	200	230	250
Ext Ø	130	150	180	200	230	250	280	300



Ceiling Hanger 95750

Int Ø	80	100	130	150	180	200	230	250
Ext Ø	130	150	180	200	230	250	280	300

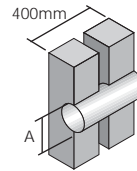

Wall Sleeve 94980

Int Ø	80	100	130	150	180	200	230	250
Ext Ø	130	150	180	200	230	250	280	300
A	180	200	230	250	280	300	330	350

Flashings

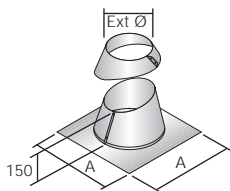

Angled Flashing Kit 5° - 45° 95510

Int Ø	80	100	130	150	180	200	230	250
Ext Ø	130	150	180	200	230	250	280	300
A	610	610	610	700	700	700	800	800

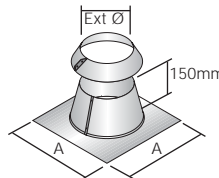

Flat Flashing Kit 95530

Int Ø	80	100	130	150	180	200	230	250
Ext Ø	130	150	180	200	230	250	280	300
A	610	610	610	610	610	610	610	610

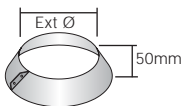

Storm Collar 95560

Int Ø	80	100	130	150	180	200	230	250
Ext Ø	130	150	180	200	230	250	280	300

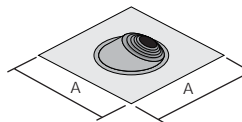

Uniflash

Product Code	94540001	94540002	94540003
Ext Ø (mm)	80-200	150-300	250-450
A	500	685	800

Universal EPDM rubber/aluminium flashing. Just pull the required diameter tab on the rubber seal.

Terminals

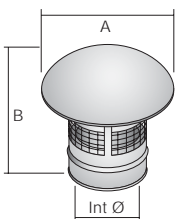

Raincap with mesh ICS J2137
without mesh ICS J2156

Int Ø	80	100	130	150	180	200	230	250
A	266	266	266	362	362	362	362	362
B	210	213	219	213	217	220	225	229

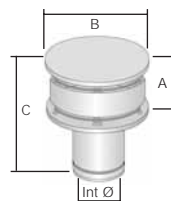

Anti-Splash Anti-Downdraught Terminal (Gastec Approved) with mesh ICS J2144
without mesh ICS J2143

Int Ø	80	100	130	150	180	200	230	250
A	134	134	130	175	200	200	250	275
B	200	230	254	304	359	409	459	509
C	224	224	220	265	290	290	340	365

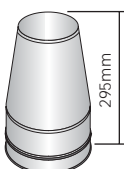

Insulated Tapered Terminal ICS J2138

Int Ø	80	100	130	150	180	200	230	250
-------	----	-----	-----	-----	-----	-----	-----	-----

Installation

Mandatory Requirements

Connection to an appliance which is not connected to the fuel supply, may be carried out by a competent person. However, connection to an appliance that is connected to the fuel supply must be carried out by a GAS SAFE (gas) or OFTEC (oil) registered installer. We recommend the use of HETAS approved installers for solid fuel applications.

The flue system must be installed to comply with Building Regulations Document J (in England, Wales & Northern Ireland). Separate Building Regulations apply in Scotland. The installation must also comply with BS EN15287 Parts 1 & 2 and BS5440 pt 1: 2000 for gas flues up to 70kW.

Joining

Pipes, bends, tees and flue gas carrying components are joined together by a simple push fit. The joint is then secured by fitting a locking band. The male spigot should be uppermost and pointing in the direction of the terminal as indicated on the product label. All components with a female form will be supplied with a locking band.

Gaskets should be fitted dry and lubrication applied to the internal of the female liner socket.

Joints are not permitted within wall and ceiling spaces. Any flue pipe (i.e. single wall) connection to the chimney must be made in the same room as the appliance. The chimney must project at least 150mm below the ceiling. Where a chimney passes through a wall, a wall sleeve must be used to prevent damage to the chimney and the building.

Adjustable Length

The ICS range of adjustable pipes provides flexibility during installation. Assembly is achieved by the removal of the insulation (if necessary) to the desired length, and is then secured using the jointing band supplied. The adjustable length is not loadbearing, therefore adequate support must be provided immediately above.

Connection to Appliance

Use the appropriate appliance connector, sealing with fire rope and fire cement or high temperature sealant on solid fuel appliances and the appropriate lip seal in the case of condensing appliances. The inner liner should not project below the appliance outlet spigot and can be cut to length if required.

Appliance Removal

Use of an adjustable length immediately above the appliance enables removal of the appliance later without dismantling the full system.

Painting

If required to be painted, simply clean the surface with a solvent cleaner (White Spirit), apply a coat of primer and a top coat of high temperature paint e.g. enamel. Extreme care must be taken when cleaning with solvent to ensure that it does not come into contact with the insulation within the cavity or gasket if fitted.

Distance to combustibles

In accordance with building regulations it is essential that the correct distance to combustible material is maintained. On solid fuel applications, where there is a risk of soot fire, a distance of 60mm to combustibles must be maintained within a combustible floor and within a combustible shaft (see Fig.1). There is no need to line the area within the floor cavity with plasterboard; however the ventilated fire stop plate and ventilated support plate must be used.

On gas and oil applications, a distance of 50mm to combustibles must be maintained within a combustible floor and within a combustible shaft. The ventilated fire stop plate and ventilated support plate must be used.

Where the chimney penetrates a non combustible floor and where a non combustible shaft is used, a distance of 50mm to the shaft is sufficient. In this case, non ventilated fire stops and non ventilated support plates may be used at first floor level with a ventilated fire stop being used where the chimney penetrates into the roof space.

On condensing appliances, where temperatures will not exceed 250°C, the tested and approved distance to combustibles is zero mm.

Typical installation using ICS Plus

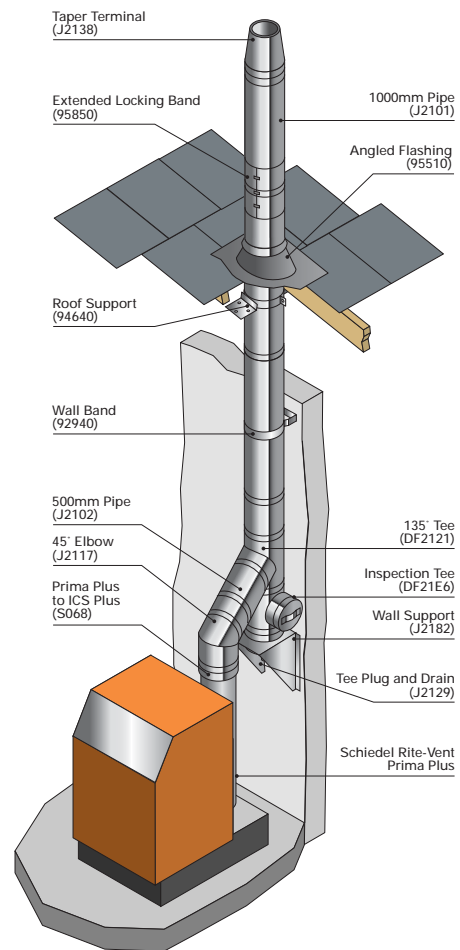
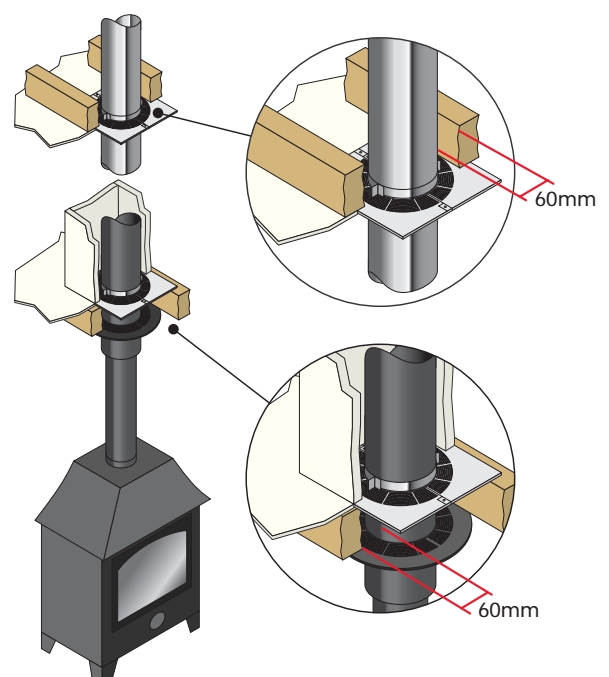

Fig.1 Distance to Combustibles from outer case of chimney



Typical installation of ICS25 through a combustible floor and shaft

Support Components

The weight of a chimney system is considerable and requires independent support. Minimal weight should be taken by the appliance. The weight of the chimney can be supported from floor level using a Base support plate or Telescopic floor support; from the wall by using wall support top plates together with side plates or cantilever brackets; or from first floor level using a support plate and clamp fixed to the floor/ceiling joist.

Wall brackets and roof brackets are not load bearing and provide lateral support only.

Refer to load bearing tables on p.15 for full details of maximum loadings.

Where the flue is free standing above the roof and its height exceeds 1.5m beyond the last support or the roof, a guy wire bracket must be used, and every 1.5m thereafter. Alternatively, a height of up to 3m can be achieved unsupported with the use of an extended locking band at the joint immediately below and every joint above the roof level.

Typical Installations

Wood / Multifuel

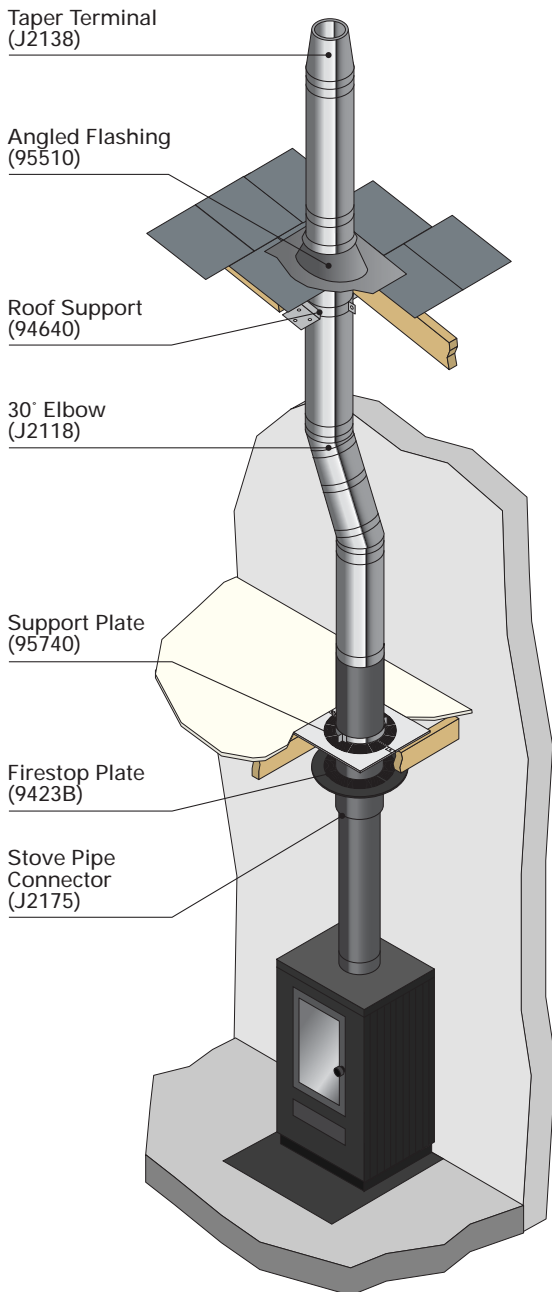

Open Fire

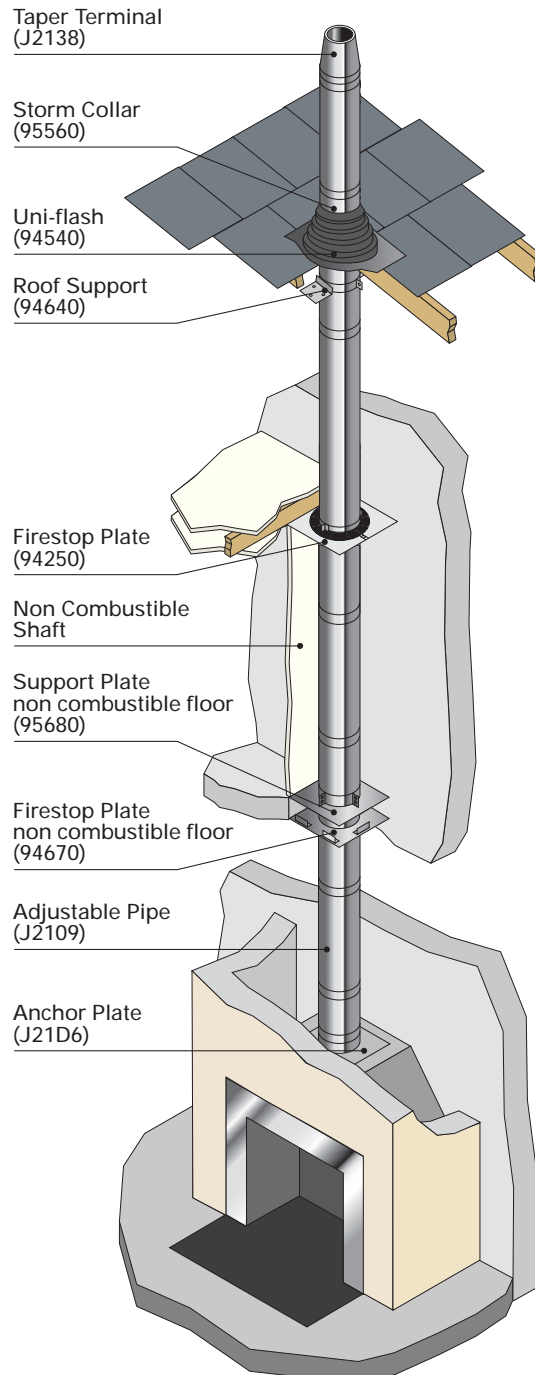

After Installation

Testing before use

This is carried out using a flue flow test as described in BS EN 15287 parts 1 & 2, with reference to the appropriate appliance type.

Maintenance

It is essential that the flue way be kept clear at all times in the interest of good practice and health, safety and appliance performance. The system should be checked regularly during the appliance maintenance.

(Refer to appliance manufacturer's instructions).

Product Warranty

Under normal operating conditions and providing the system is installed correctly, it should last the lifetime of the appliance which is normally 10 years. ICS carries a 10 year conditional warranty.

The conditions are that the chimney is:

- correctly sized + installed
- properly maintained
- burning only approved fuels in accordance with the Schiedel Rite-Vent and appliance manufacturer's instructions.

Load Bearing Data (metres of pipe)

Internal Diameter (mm)	80-130	150-180	200-250
Base Drain Section	22	18	18
Adjustable Top Plate + Locking Band	15	15	15
Telescopic Floor Support	18	18	18
Pair or Side Plates (see diagram A)	15	15	15
Pair or Side Plates (see diagram B)	10	10	10
Cantilever Support	22	18	18
Extension Support (Anchor Plate)	1.5	1.5	1.5
Ventilated Support Plate (All types)	12	12	9
Support Plate	12	12	9
Ceiling Hanger	1.5	1.5	1.5
Wall Band 50mm	3	3	3
Adjustable Wall Band 75-300mm	3	3	3
Structural Wall Band	4	4	4
Extension for Structural Wall Band	4	4	4
Guy Wire Bracket	1.5	1.5	1.5
90° Tee + Locking Band	22	18	18
93° Tee + Locking Band	22	18	18
135° Tee + Locking Band	15	10	10
Inspection Tee (Round)	22	18	18
Inspection Tee (Rectangular)	22	18	18

For recommended fuels listings, please refer to the HETAS guide (www.hetas.co.uk), or appliance manufacturer's instructions. Warranty registration details are provided with installation instructions for completion and registration with Schiedel Rite-Vent.

Approx Weight of Products (kg)

Int Dia	Length	1000mm	500mm	250mm	195mm
80mm		4.32	2.13	1.09	0.85
100mm		5.14	2.53	1.29	1.01
130mm		6.35	3.14	1.60	1.24
150mm		7.18	3.54	1.86	1.41
180mm		8.40	4.14	2.11	1.65
200mm		9.22	4.55	2.31	1.80
230mm		10.44	5.13	2.62	2.03
250mm		11.24	5.53	2.81	2.19

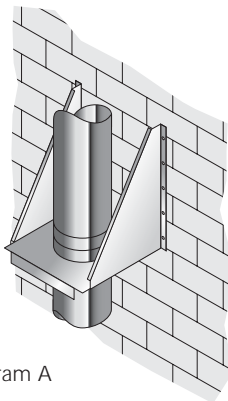

Diagram A

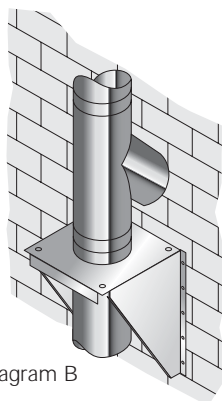

Diagram B



INSTALLER HELPLINE

+44 (0) 191 416 6666

More information on www.schiedel.co.uk



ICS

Twin wall insulated chimney system for gas, oil, wood and multifuel appliances and open hearths

Residential and commercial applications.

80-700mm internal diameters.

For atmospheric, condensing and pressure appliances.

Wet or dry flue and chimney operating conditions.

Other products in the Schiedel Rite-Vent range



B Vent

Twin wall gas venting system.

Residential & small commercial applications. 100-150mm internal diameters.

Gas appliances up to 60Kw input.



K Vent

Twin wall insulated venting system for oil (28 sec) and gas appliances.

Residential and small commercial applications.

100-150mm internal diameters.

Oil appliances up to 45Kw output.

Gas appliances up to 60Kw input.

Interfits with B Vent gas vent.



ICID

Quick assembly twin wall insulated chimney system for gas, oil, wood and multifuel appliances and open hearths.

Residential and small commercial applications.

125-300mm internal diameters.

Quick assembly twist-lock joint.

For class 1 chimneys, atmospheric and condensing appliances.



Prima Plus

Single wall stainless steel flue system. 80-700mm diameter range.

Prima Plus 1mm for domestic multi fuel stoves.

Prima Plus for large residential and commercial condensing gas and oil appliances and chimney relining.



Flue Boxes

For installing gas fires and back boilers.

Connection to single and twin skin flexible liners, B Vent, ICS or ICID.

Fast fix spigot for flex connection avoids much of the building work.

Single skin and twin skin air-insulated versions.



Flexible Flue Liners

For relining existing chimneys to take gas, oil, wood, multifuel appliances and open fires.

Single skin Wonderflex and Triplelock for gas and oil (28 sec).

Twin skin Tecnoflex for oil, wood, multifuel and open fires.

80-300mm diameter range.

Schiedel Chimney Systems

Crowther Estate
Washington
Tyne & Wear NE38 0AQ
Tel. +44 (0)191 416 1150
Fax. +44 (0)191 415 1263
info@schiedel.co.uk
www.schiedel.co.uk

Schiedel Chimney Systems

Washingbay Road
Coalisland
Co. Tyrone BT71 4ND
Tel. +44 (0)28 8774 0436
Fax. +44 (0)28 8774 7430
info@schiedel.co.uk
www.schiedel.co.uk

