

SCHIEDEL

RITE-VENT



B



B VENT

**Twin wall gas venting system
and flue box range.**

- Gas appliances up to 60kW input
- 100 - 150mm internal diameter
- Flue boxes and chimney system to fit gas fires in rooms without a conventional chimney
- Residential and small commercial applications



DOC/CP3/42 Issue 4 March 2009
E. & O.E. Lit BV 0805



MONIER

Application

Twin wall gas heating system designed for cost-effective venting of residential and small commercial atmospheric gas appliances with input up to 60kw. It is suitable for both internal and external use, either as a complete system or in combination with masonry, i.e. flue blocks or brick chimneys.

Note that BS 5440-1 requires the use of a stainless steel insulated flue on external runs exceeding 3 metres. K Vent fulfills this requirement and is fully interchangeable with the B Vent range.

Product Description

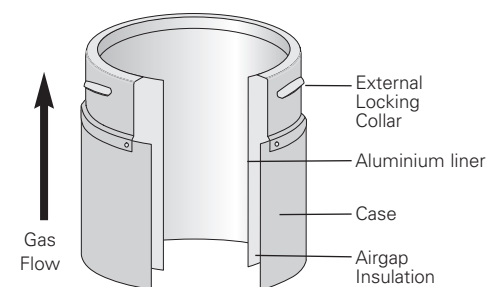

- **Twist-lock bayonet jointing system.**
- **No locking bands required.**
- **Aluminium inner liner and aluzink outer case which can be painted if required.**
- **12.5 mm air gap between case and liner keep case temperature low.**
- **0-90° adjustable bend.**
- **When joint is made, the liner covers the jointing collar, shielding it and permitting easy drain-down of any moisture in the flue.**

Flue Sizing

Flue Size Selection Guide			
	100mm	125mm	150mm
Gas Central Heating Boiler (Wall hung/Freestanding) Input up to 25kW Input 25kW-40kW Input 40kW-60kW	●	●	●
Gas Fires - "Radiant" to BS 7977-1 Gas Fires - "Inset" to BS 7977-1 Gas Fires - "Backboiler" to BS 7977-2		● ●* ●	
Gas Water Heaters - Input up to 25kW Gas Water Heaters - Input 25kW -55kW Gas Water Heaters - Input 55kW -60kW	●	●	●
Gas Stove/Cooker - (AGA/Rayburn/Stanley etc.)	●	●	●
Gas Flue Blocks - Connection IN Gas Flue Blocks - Connection OUT	●	●	
Gas Warm Air Unit Input up to 18 kW Input 18kW-35kW Input 35kW-60kW	●	●	●

*When the fire has been tested and relaxed to 125° the appliance manufacturer should be consulted.

Flue size selection

B Vent is available in 100, 125 and 150mm internal diameters. The flue size must be as recommended by the appliance manufacturer and **must not** be reduced, and never smaller than the appliance spigot.

This information is provided as a guide only, and for exact flue sizing recommendations, refer to appliance manufacturer's installation instructions and design guide.

Approvals

B Vent is **CE certified to EN1856-1 with the designation T250 N1 D Vm L11040 050 (certificate number 0036 CPD9195013).**

It is also kitemarked to BS715 1993 (certificate number KM5518 in 100 and 125 diameters) and is manufactured under the Quality Assurance requirements of BS EN ISO 9001.

System Design

Outlet termination

Flue terminations for gas in domestic situations are governed by BS5440-1 Section 4.2. The figure below illustrates recommendations for the most common terminations.

Adjacent taller structures may require increased height. The minimum flue projection through the roof is 600mm to the underside of the terminal.

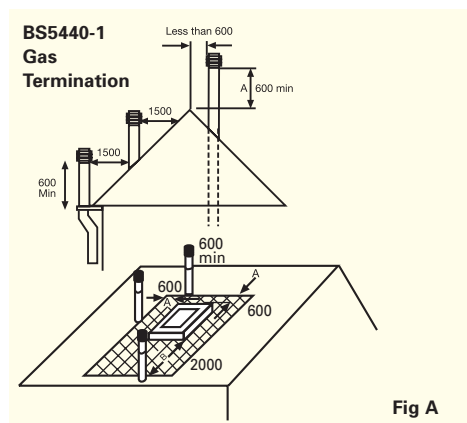

Fig A

Flue routing

Systems should be vertical as far as possible for most efficient evacuation and should not exceed 45° from the vertical, otherwise resistance to flue gas flow will result. Bends should be kept to a minimum and a vertical rise of 600mm minimum should be allowed for immediately above the appliance.

As a general rule, the vertical distance (A) between the appliance and the flue terminal should always be at least twice the horizontal distance (B) between the appliance and the terminal (see Fig B).

The B Vent range includes 0° - 90° fully adjustable bends which can be used where the flue system needs to be offset e.g. to avoid trusses and terminate to a ridge terminal. These bends can be rotated 360° after the angle has been set to achieve the correct direction of flue parts.

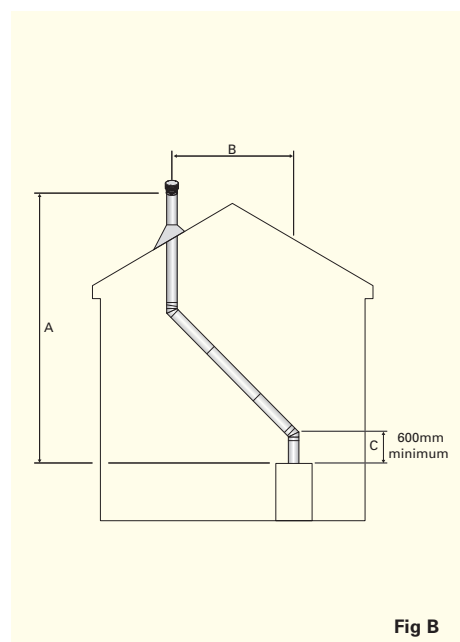

Fig B

Air Supply

Provision for ventilation to supply air to the appliance must be arranged in accordance with the appliance manufacturers instructions. This is necessary to ensure correct and safe operation of the appliance and to ensure correct venting and avoid spillage of flue gases.

Use of B Vent on condensing appliances

B Vent is not suitable for this application. Prima Plus and ICS Plus are the products in the Rite-Vent range specifically designed for condensing applications.

Termination beside existing chimney pots

A commonly encountered situation is the need to site the termination of a gas appliance amongst chimney pots on an existing stack. The termination should be made such that the bottom of the terminal is at the same level as the top of the surrounding pots. This is to ensure maintenance of suitable draught conditions.

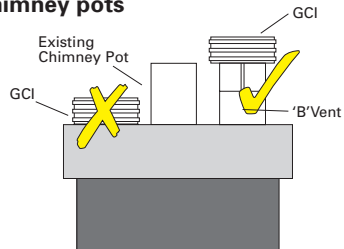

Terminal Extension Kit BVTERMEXTKIT
To comply with BS5440-1:2000 clause 5.1.6.

Schiedel Chimney Systems supply a British Gas approved Terminal extension kit for this purpose.

Use of K Vent to combat condensation

With the advent of high efficiency gas appliances, which have generally lower flue temperatures, condensation problems can arise where the system is exposed to extreme conditions of cold, particularly external runs and ventilated roof spaces of modern properties.

K Vent, which interconnects directly with B Vent can help overcome this problem and maintain the efficiency of the flue. With its stainless steel liner and high quality insulated cavity, K Vent assists the speedy evacuation of flue gases with minimum heat loss. This maintains flue gas temperature, reducing the formation of condensation and produces a more efficient system. The stainless steel liner helps resist the corrosive effect of any condensation which may still form.

Compliance with BS5440-1:2000.5.1.7

BS5440-1:2000.5.1.7 requires the use of stainless steel insulated flue on all exterior gas flues greater than 3 metres. K Vent, having a stainless steel liner and Superwool insulation is interchangeable with B Vent and should be used for exterior installations. See the K Vent brochure for more information.

Fitting a gas fire where no suitable chimney exists

For rooms without a chimney a gas fire can be fitted using a flue box and a rigid twin wall chimney. B Vent is ideal for most situations, although some decorative gas fires require a larger flue in which case an ICS or ICID chimney (see separate brochures) should be used.

- With the appropriate flue box the flue can be routed either in the same room or an adjoining room.
- The flue box has a twin wall construction to provide insulation and minimise the risk of condensation.

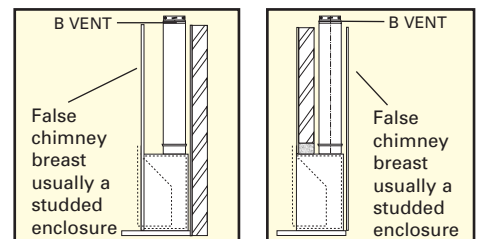

Which flue box and flue to choose

TYPES OF FIRE	SPECIFICATION	STANDARD	TYPE OF FLUE BOX	FLUE SIZE & TYPE
RADIANT	Safety of Domestic Gas Appliances—Specification for Gas. Fires 1st, 2nd and 3rd family gases for radiant and convector radiant.	BS 7977-1 2002	Standard B Vent 0185125 Recessed B Vent 0184125	125mm B Vent
BACK BOILER UNIT	Safety of Domestic Gas Appliances—Combined Appliances: Gas fires/Back Boiler.	BS 7977-2 2003	Back Boiler Box 0165125 B Vent	125mm B Vent
LIVING FLAME FIRES	Safety of Domestic Gas Appliances—Specification for inset Live Fuel Effect Gas Fires up to 7kW.	BS 7977-1 2002	ILFE Box 0189125 B Vent J2141180 ICS	180mm Conforming to BS 4543 Pt 3 can be relaxed to accept 125mm flue to BS 715 (see appliance manufacturers installation specifications for appliance). e.g. ICS or B Vent

This information is provided as a guide only. In all cases for exact flue sizing recommendations refer to the appliance manufacturers instructions and design guide.

Flue Boxes

Standard Flue Box

Ref: 0185125
Designed for use with radiant and decorative gas fires complying to BS 7977-1 2002. Constructed with an aluminium liner and coated steel outer case.

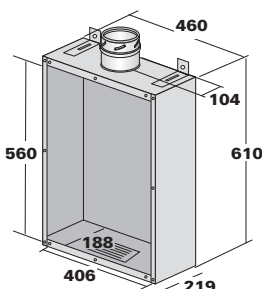

Recessed Flue Box

Ref: 0184125
Designed with the spigot at the rear, for use with larger radiant and decorative gas fires, or with B Vent installed in an adjoining room to the fire. For gas fires to BS 7977-1 2002.

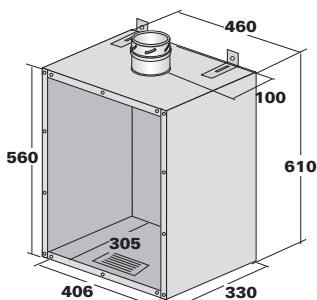

ILFE Flue Box

Ref: 0189125
For use with Inset Live Fuel Effect gas fires complying to BS 7977-1 2002, with a heat output not exceeding 7kW. **Note: For fires requiring a larger flue normally 180 or 200 mm, use ICS or ICID flue boxes. See separate brochure.**

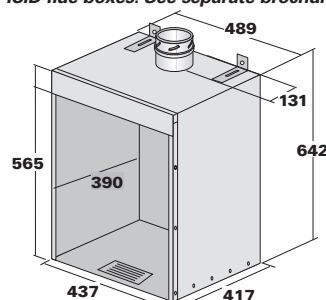

Large Flue Box for Back Boiler

Ref: 0165125
Adjustable in depth from 358mm to 480mm to accommodate a wide range of back boilers, Suitable for fires complying with BS 7977-2 2003. **Universal opening allowing connection to the boiler with B Vent or Flex.**

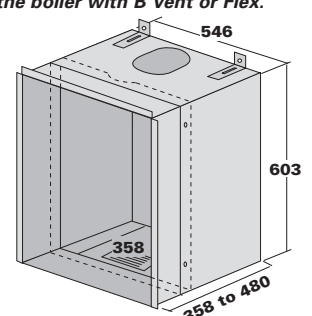

Dimensions

The internal and external dimensions of the flue are:

IntØ (mm)	100	125	150
ExtØ (mm)	127	152	178

Component Ordering

When ordering, state the product code followed by the internal diameter, e.g. for a 125mm dia. 900mm long pipe, the full code would be 1202125.

Starting Components

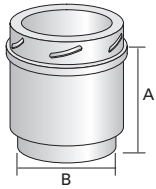

Appliance Connector Economy 1246

IntØ (mm)	100	125	150
ExtØ (mm)	127	152	178
A	113	113	113
B	104	130	156

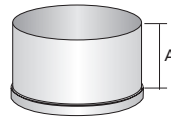

B Vent to Flex Conn 1279

IntØ (mm)	100	125	150
ExtØ (mm)	127	152	178
A	75	75	75

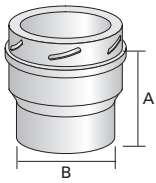

Flue Block Adaptor 0145

IntØ (mm)	100	125
ExtØ (mm)	127	152
A	90	90
B	114	138

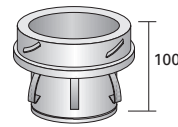

Flex to B Vent Conn 1278

IntØ (mm)	100	125	150
ExtØ (mm)	127	152	178

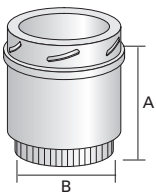

Vitreous Enamel Connector 1243

IntØ (mm)	100	125	150
ExtØ (mm)	127	152	178
A	113	113	113
B	99	125	151

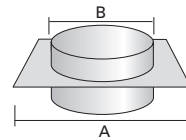

B Vent to Flue Block 0180

IntØ (mm)	100	125
ExtØ (mm)	127	152
A	190	190
B	127	154

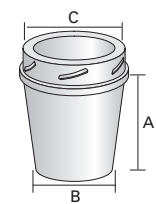

Increaser 1271

IntØ (mm)	100	125	150
ExtØ (mm)	127	152	178
A	160	160	160
B Ø	100	126	150
C Ø	125	152	180

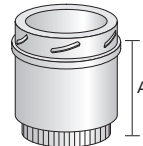

Connector (IL to B Vent) 0148

IntØ (mm)	100	125	150
ExtØ (mm)	127	152	178
A	130	95	130

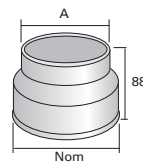

Connector (B Vent to IL) 0149

IntØ (mm)	100	125
A Ø	111	138

Pipes

IntØ (mm)	100	125	150
ExtØ (mm)	127	152	178

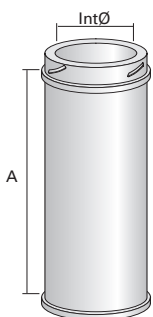

Code	Nominal Length	Effective Length A		
1201	1500mm	1470	1470	1470
1202	900mm	870	870	870
1203	600mm	570	570	570
1205	450mm	420	420	420
1206	300mm	270	270	270
1207	150mm	120	120	120

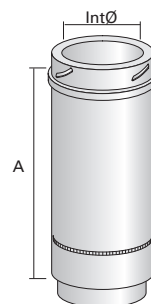

Code	1208	1209
A	450	300
Effective Length	50mm - 380mm	50mm - 230mm

Slide over male of pipe below.
Tighten jubilee clip.
Min. 40mm overlap.
Do not use after bend or tee since insufficient overlap.

Bends

Adjustable 0° - 90° Bend 1218

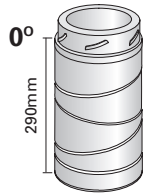

IntØ (mm)	100	125	150
-----------	-----	-----	-----

Rotate segments to create any angle. Bottom segment rotates, enabling exact alignment of bend.

For Int Ø 75mm bends use:

Fixed 0° - 45° Bend	1217
Fixed 0° - 60° Bend	1216
Fixed 90° Bend	1215

Offsets

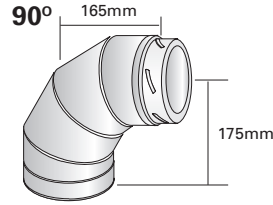
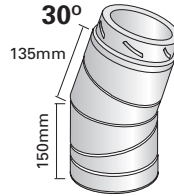

45° Offset

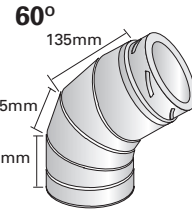
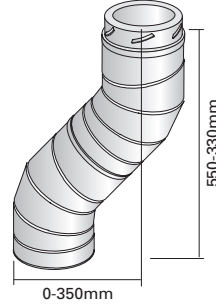

Tees

90° Tee 1220

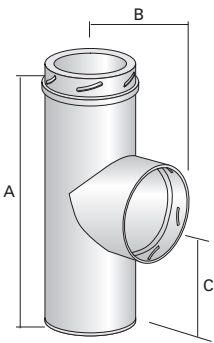

IntØ (mm)	100	125	150
ExtØ (mm)	127	152	178
A	360	360	360
B	145	152	160
C	180	180	180

135° Tee 1221

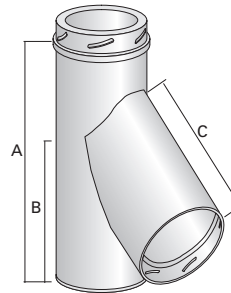

IntØ (mm)	100	125	150
ExtØ (mm)	127	152	178
A	360	360	360
B	275	275	275
C	205	225	265

Tee Cap 1224



IntØ (mm)	100	125	150
-----------	-----	-----	-----

Tee Cap & Drain 0229



IntØ (mm)	100	125	150
-----------	-----	-----	-----

Support Components

Firestop Plate 0166

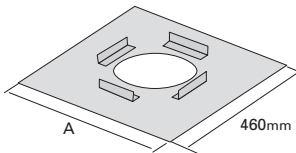

IntØ (mm)	100	125	150
A	279	305	330

Debris Plate 0164

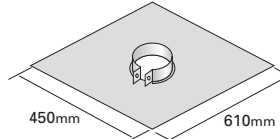

IntØ (mm)	100	125
-----------	-----	-----

Support Assembly 0160

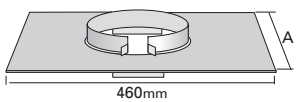

IntØ (mm)	100	125	150
A	279	305	330

Wallband 50mm extension 0173

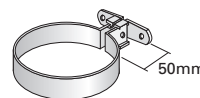

IntØ (mm)	100	125	150
-----------	-----	-----	-----

Roof Plate (2 Piece) 0167

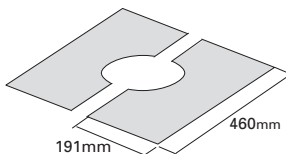

IntØ (mm)	100	125	150
-----------	-----	-----	-----

Wallband 275mm adjustment 0174

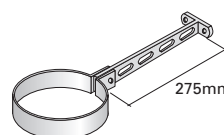

IntØ (mm)	100	125	150
-----------	-----	-----	-----

Flashings

(supplied complete with stormcollar and sealant)

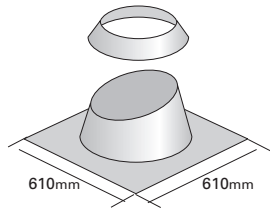

Angled Flashing Kit 5° - 30° 0151

IntØ (mm)	100	125	150
-----------	-----	-----	-----

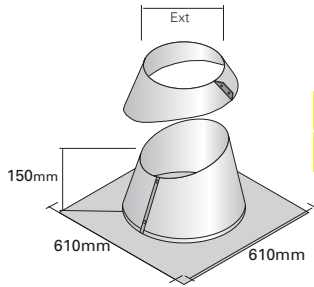

Angled Flashing Kit 5° - 45° 95510

IntØ (mm)	100	125	150
Ext	125	150	180

Order Part No. and Ext.

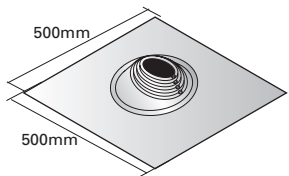

Uniflash 80-200mm 9454001

IntØ (mm)	100	125	150
-----------	-----	-----	-----

Storm Collar not required.

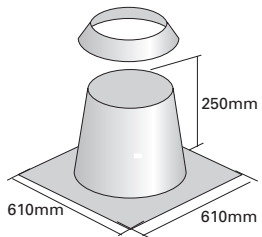

Flat Flashing Kit 0152

IntØ (mm)	100	125	150
-----------	-----	-----	-----

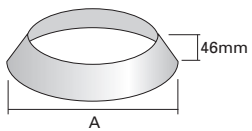

Storm Collar 0156

IntØ (mm)	100	125	150
A	220	248	270

Terminals

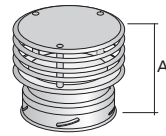

GCI 0130

IntØ (mm)	100	125	150
A	100	100	85

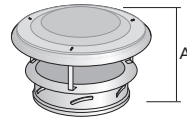

Raincap 0133

IntØ (mm)	100	125	150
A	127	150	178

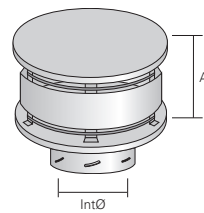

Anti Splash Anti Draught 0128

IntØ (mm)	100	125	150
A	110	130	170

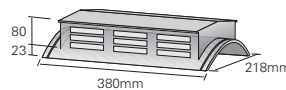

Ridge Tile Top 0142

IntØ (mm)	100	125
-----------	-----	-----

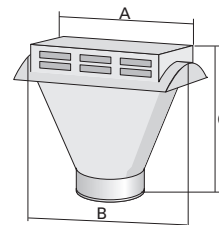

CVTA (Combined Vent Tile and Adaptor) 0139

IntØ (mm)	100	125
A	330	330
B	380	380
C	330	330

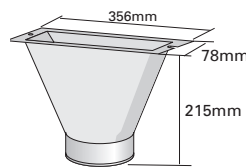

Ridge Tile Adaptor 0135

IntØ (mm)	100	125
-----------	-----	-----

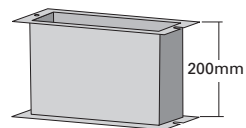

Ridge Tile Adaptor Extension Box 0136

To fit apex of steeply pitched roofs.

Installation

Mandatory requirements

Connection to an appliance which is not connected to the fuel supply may be carried out by a competent person. However, connection to an appliance that is connected to the fuel supply **must** be carried out by a CORGI (gas) registered installer.

The flue system must be installed to comply with Building Regulations Document J (in England, Wales and Northern Ireland) for gas appliances having a flue gas temperature of 250°C max, and the Building Regulations for Scotland. The installation must also comply with BS5440 pt 1 : 2000 for gas flues up to 60 kW in the UK and IS813 Domestic Fuel Installations in Ireland.

Joining

All pipe lengths and flue gas carrying components are joined together by a twist lock, bayonet system. The system should be installed with the visible male collar pointing upwards, this is reaffirmed by the directional arrow pointing upwards, indicating the directional flow of flue gases. Taping of joints is unnecessary. B Vent is for atmospheric appliances which have negative pressure flues meaning that when the system is primed and running at normal operating temperatures, air is drawn into the flue via the joints, assisting safe evacuation of flue gases.

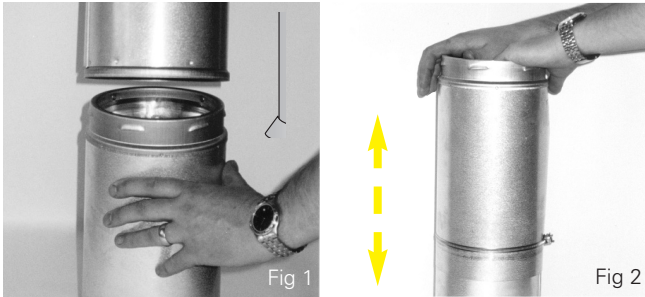

Adjustable Length

Within the range is an adjustable length which is used to telescope over standard pipe lengths to provide the exact flue lengths required. It should not be used directly after a bend since there is insufficient overlap to insure a sound joint. A wall band must be used above an adjustable length as this component is not loadbearing - see Fig 2.

Connection to Appliance/Flue Block

Always use an appliance connector, sealed using fibre rope and fire cement or high temperature sealant. The liner should not project below the appliance outlet spigot and can be cut to length if required.

Appliance Removal

Use of a pipe and an adjustable length immediately above the appliance enables removal of the appliance later without dismantling the full system.

Painting of B Vent

If required to be painted, simply clean the surface with a solvent cleaner (White Spirit), apply a coat of primer and a top coat of high temperature paint e.g. enamel.

Recommended distances to combustibles

In accordance with the Building Regulations, a minimum of 50mm distance to combustibles **must** be maintained. B Vent support components provide a 50mm clearance. At the maximum flue gas temperature of 250°C, the outer case will be in the region of 75-85°C.

Support components

Internal systems should be supported by using a support assembly fixed on top of the first floor/ceiling joist. A Firestop plate is also required fixed to the ceiling below. The clamp plate and firestop have tags fixed to ensure 50mm distance to combustibles. In a normal house, when passing through the second floor the only requirement is two firestop plates because the system is adequately supported at first floor level.

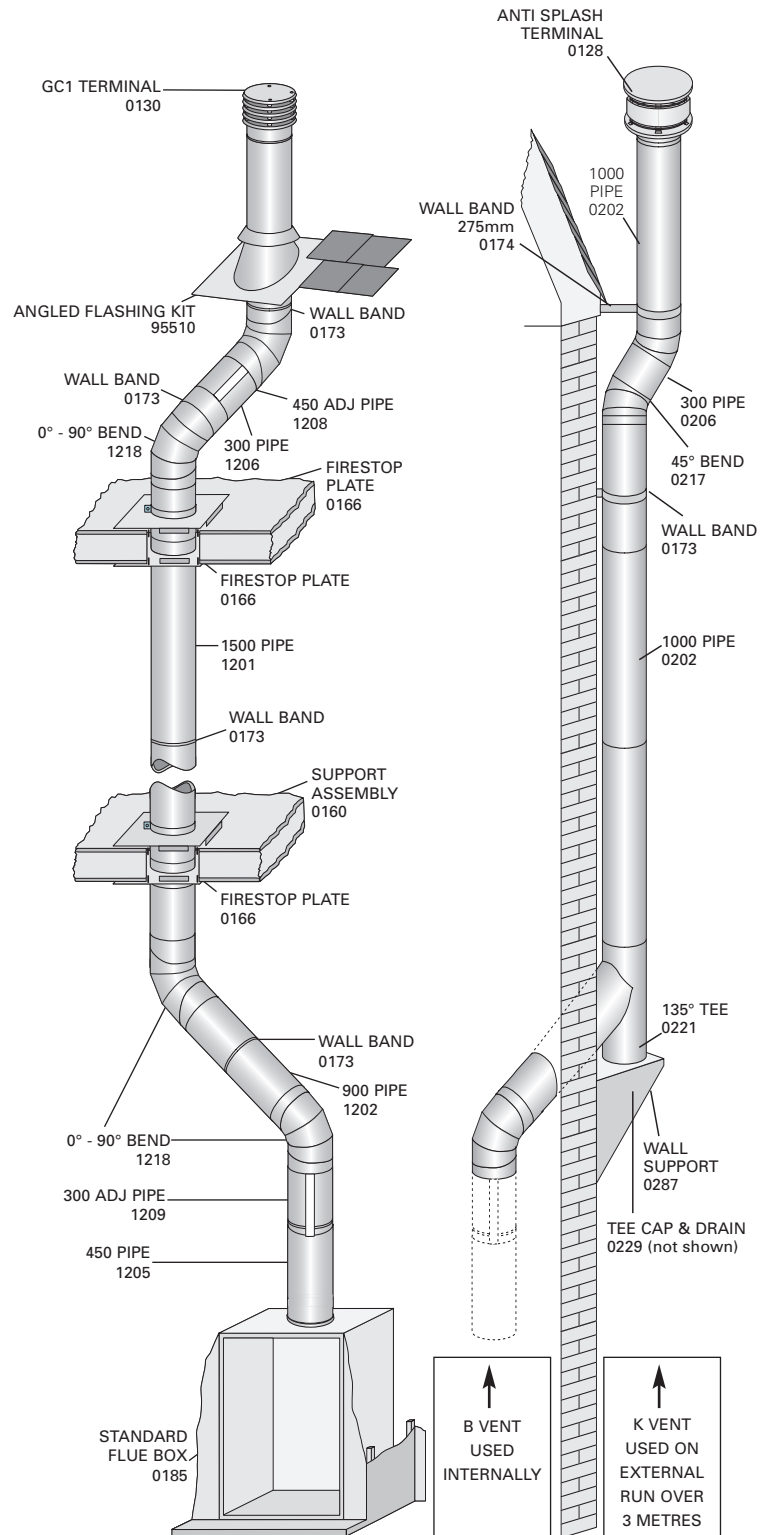

Wallbands are not load bearing and give lateral support only. Wallbands should be fitted every 3m to ensure the system is rigidly held. The system should be braced with a wallband immediately below passing through the roof line to ensure the flashing does not suffer lateral pressures.

Ensure that no joint occurs within the floor space. A roof plate (2 piece) should be used on the underside of roof trusses where the system is terminated via a flashing.

The maximum height unsupported above the roof line is 1.5m. Where a joint is above the roofline it should be determined that in extreme wind conditions this joint would not be over exerted. If there is any doubt then a guy wire should be used. Beyond this guy wires should be installed every metre.

Loft and Ridge Connection

Use a flue block adaptor to start from the flue block. The connection to the ridge terminal should be sealed using a gasket (supplied on request) or high temperature sealant to provide a gas and condensate tight joint.

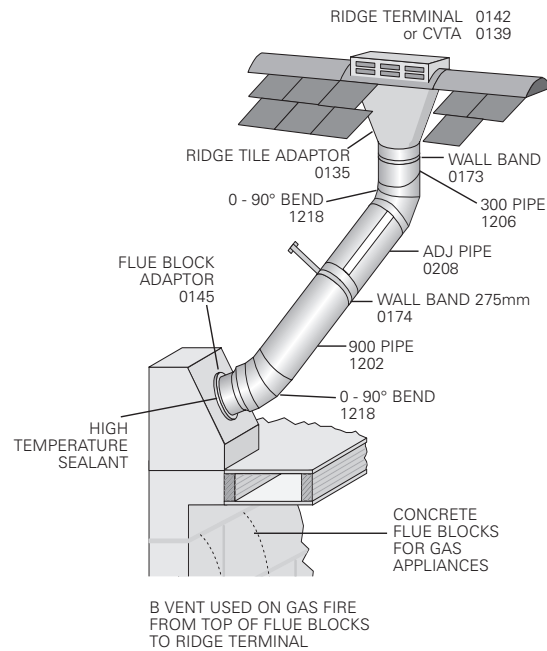

Connection of B Vent to an existing chimney

B Vent is not for use as a chimney liner, however, it can be used to connect to and from a Wonderflex/Triplelock flexible flue liner which may be lining an existing chimney, when used on appliances described in previous section.

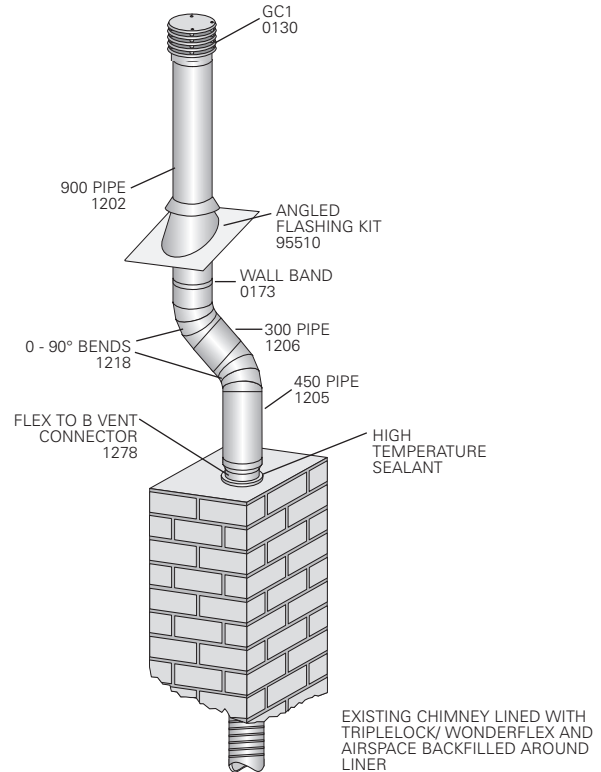

After Installation

Testing before use

This is done by means of a flue flow test as described in BS5440:Part 1-2000. It can be summarised as follows:- After a visual and physical check of the joints in the system, and ensuring an adequate air supply for combustion has been provided, close all doors and windows in the room in which the appliance is to be installed. It will be necessary to introduce heat to the flue system for a minimum of 10 mins. and possibly up to 30 mins. using a blow torch or similar. Position a smoke pellet (providing a performance of 5m³ of smoke in 30 secs. burn time) at the intended position of the appliance. The test is satisfactory if there is no significant spillage from the appliance position, no seepage over the length of the system, and discharge only from the terminal. If these conditions are not met, the test has failed and all faults must be rectified and the system retested before connection of the appliance to the fuel supply. In the event of any further problems, reference to BS5440:Part 1-2000 must be made.

Maintenance

It is essential that the flue way be kept clear at all times. The system should be checked regularly during the appliance maintenance (refer appliance manufacturer's instructions).



INSTALLER HELPLINE

+44 (0) 191 416 6666

More information on www.schiedel.co.uk

Schiedel Chimney Systems

Crowther Estate
Washington
Tyne & Wear NE38 0AQ
Tel. +44 (0)191 416 1150
Fax. +44 (0)191 415 1263
info@schiedel.co.uk
www.schiedel.co.uk

Schiedel Chimney Systems

Carrickmacross
Co. Monaghan
Ireland
Tel. +353 (0)42 966 1256
Fax. +353 (0)42 966 2494
office@schiedel.ie
www.schiedel.ie

