

# Users Guide & Installation

DUAL FUEL RANGE COOKER



RCM10 FRS/FRSP

RCM10 FRK/FRKP



Leisure Consumer Products  
36-38 Caxton Way  
Watford  
Herts WD18 8UF  
Tel: 0845 6004916  
Facsimile: 0845 6004922  
[www.Leisurecp.co.uk](http://www.Leisurecp.co.uk)

Part no. 485.9207.63/25.10.2007

Your Cooker is guaranteed against the cost of breakdown repairs for twelve months from the date of the original purchase.

**What is covered?**

- Repairs necessary as a result of faulty materials, defective components or manufacturing defects.
- The cost of functional replacement parts, but excluding consumable items.
- The labour cost of a Leisure Consumer Products approved repairer to carry out the repair.

**What is not covered?**

- Transit, delivery or accidental damage or misuse and abuse.
- Cabinet or appearance parts, including knobs, flaps, handles or container lids.
- Accessories or consumable items including but not limited to filters and light bulbs.
- Repairs required as a result of unauthorized repair or inexperienced installation that fails to meet the requirements contained in the user instruction book.
- Repairs to products used on commercial or non-residential household premises.

**Important notes**

- Your Leisure Consumer Product is designed and built for domestic household use only.
- The guarantee will be void if the product is installed or used in commercial or non-residential domestic household premises.
- The product must be correctly installed, located and operated in accordance with the instructions contained in the User Instruction Booklet provided.
- Professional installation by a qualified Electrical Domestic Appliance Installer is recommended for all Washing Machines, Dishwashers, Electric Cookers and Cooker Hoods.
- Gas Cookers must only be installed by a CORGI ( or BORD GAIS) registered Gas Installer.
- The guarantee is given only within the boundaries of the United Kingdom and the Republic of Ireland.
- The guarantee is applicable only to new products and is not transferable if the product is resold.
- Leisure Consumer Products disclaims any liability for incidental or consequential damages.
- The guarantee does not diminish your statutory or legal rights.

*Please keep your purchase receipt or other proof of purchase in a safe place; you will need to have it should the product require attention under guarantee.*

You should also complete the details below; it will help us assist you when requesting service. (The model is printed on the Instruction Booklet and Serial Number is printed on the Rating Label affixed to the appliance)

Model No: _____	Serial No: _____
Retailer: _____	Date of purchase: _____

**For service under guarantee simply telephone the appropriate number below**

**UK Mainland & Northern Ireland**

Fridges & Freezers	0845 600 4903
Electric Cookers	0845 600 4921
Gas & Dual Fuel Cookers	0845 600 4921
Washing Machines & Dishwashers	0845 600 4906

**Republic of Ireland**

All Refrigeration,	01862 34 11
All Cookers,	
Washing Machines & Dishwashers	

**Before requesting service please check the trouble-shooting guide in the Operating Instructions as a charge may be levied where no fault is found even though your product may still be under guarantee.**

**Service once the manufacturer's guarantee has expired**

If you have purchased an extended guarantee please refer to the instructions contained within the extended guarantee agreement document. Otherwise please call the appropriate number above where service can be obtained at a charge.

Should you experience any difficulty in obtaining service please contact the Leisure Consumer Products Customer Help-Line.

Tel: 0845 600 4918 e-mail: [service@leisurecp.co.uk](mailto:service@leisurecp.co.uk)

Dear customer

Congratulations on your choice of a Leisure quality cooker which has been designed to give you lasting service.

The cooker must be installed by a qualified electrician in accordance with current regulations and used in a well ventilated space.

Please read these instructions thoroughly before installing or using - and keep for handy reference. Make sure you understand the controls prior to using your appliance. This cooker must only be used for its intended purpose, ie the cooking of food in the home. Failure to observe these instructions may invalidate your right to free service during the guarantee period.

If you have any questions, or if you are not sure about any information contained in this booklet please contact us - details are on the back cover.

Your Customer Service

# safety symbols

The use of any electrical appliance and cookers in particular (which use high temperatures) require the following of basic common sense safety rules.

There is a danger of injury to the person and of damage to the cooker, the kitchen and your home.

These are itemised in the first section 'Safety in the home'. Where accidents are most common, we repeat these warnings in the main text using the following symbols:



**Where you, other people, toddlers and children are at risk**



**Where there is a danger of damage to the cooker, utensils, surrounding areas and property**

Please note them for your own safety.

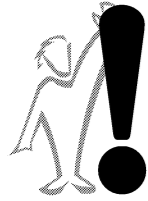

## Introduction

Welcome/Safety symbols	2
Safety in the home	4

## Installation

Know your cooker/specification	6
Electrical connection and location	7
Installation	8

## For the very first time

Preparation and burning off	9
Gas connection	10
Gas conversion	11

## Operating

Operating the hob	12
Saucepan types	13
Deep fat frying	14
Operating the dual grill	15
Operating the conventional oven	16
Operating the fan oven	17
Operating the digital programmable timer	18-22

## Cooker care

Care & cleaning	23
Trouble shooting	24
Replacing the oven light	24
Future transportation	24
Guarantee & service	25

## If the cooker does not work

If the appliance does not operate check whether:

- The power supply is on.
- The fuse has blown/circuit breaker has tripped/main distribution switch has been turned off.
- The temperature control has been set correctly.
- The main oven will not operate if the clock has not been set.
- This cooker must be earthed if in doubt consult a qualified electrician.

If the appliance is still not operating after the above checks, please refer to the section on how to obtain service.

**Please ensure that the above checks have been made as a charge will be made if no fault is found.**

## Performance characteristics when in use

- **When using your appliance for the first few times, an odour and/or smoke may be emitted which is normal - see Preparation and Burning off.**
- It is normal for the metal parts to produce noise when in use, this is due to expansion and contraction.
- When in use, steam may be produced which is normal and not a fault of the cooker.
- At the end of a cooking session, it is normal to have a momentary puff of steam when the oven door is opened. This should disperse in a few seconds.
- If, whilst cooking, steam produced comes in to contact with cool surface's on the outside of the appliance, it will condense and produce water droplets. This is quite normal and is not a fault.

## replacing the oven lamp

### Warning:



Ensure the appliance is switched off at the mains before replacing the lamp to avoid the possibility of electric shock.

### Switch off at the mains.

- 1 Remove the glass cover of the lamp by turning it anti-clockwise.
- 2 Remove the bulb by turning it anti-clockwise.
- 3 After installing the correct bulb, reinstall the glass cover.

Replacement light bulbs can be easily obtained from a good local electrical or DIY store.

## future transportation

Keep the original carton and other packaging material in a safe place. Transport the cooker in its original carton. Follow the instructions that are printed on the carton.

To prevent the accessories inside the oven from damaging the oven door, tape a strip of cardboard onto the inside of the oven door that lines up with the position of the trays. Tape the oven door to the side walls.

### If you do not have the original carton

Take the necessary precautions in order to prevent the exterior panels, and the glass surfaces of the oven from being damaged.

Pack the oven in bubble wrap or thick cardboard and tape it securely in order to prevent damage during transportation.

The oven must be transported upright. Do not place other items on the top of the cooker.

### Recycling



This product bears the selective sorting symbol for waste electrical and electronic equipment (WEEE). This means that this product must be handled pursuant to European Directive 2002/96/EC in order to

be recycled or dismantled to minimize its impact on the environment. For further information, please contact your local or regional authorities.

Electronic products not included in the selective sorting process are potentially dangerous for the environment and human health due to the presence of hazardous substances.



## Turn OFF at the mains before cleaning.

- Before switching on again ensure that all controls are in the OFF position.
- **Make sure that the oven, grill and hobs are sufficiently cool before you start cleaning.**
- Never mix different cleaning products as different active ingredients may react with unforeseen results.

## Exterior

Use a damp cloth to clean the outside. Never use any sharp instruments, abrasive household cleaner, or detergents for cleaning. For hard stains use suitable washing liquid.

## Burners

The pan supports can be removed and the top burner plate can be cleaned with soapy water and rinsed with a dry cloth.

Wash and rinse the gas burner caps and the pan supports with soapy water. Never wash them in a dishwasher. For the dirt and stains on the burner heads that does not wash off, use a proprietary metal surface cleaner.

## Hob surround

Clean with a cloth wrung out in soapy water. Stubborn stains can be removed with a cream, paste or liquid cleaner. Check that the cleaning agent used is approved by the Vitreous Enamel Development Council.

## Ceramic Hob

- Clean daily to avoid soilage being burnt on.
- 1 Be sure to use a cleaning agent that does not scratch the ceramic glass surface. We recommend Hob Brite Ceramic Hob Cleaner which is available from your local supermarket. Follow the manufacturer's instructions.
- 2 Always rinse off fully with a clean cloth wrung out in clean water (as residue could damage the ceramic glass surface next time the hob is used).
- 3 Wipe the surface dry with a soft cloth.
- **Do not use steel wool, abrasive powders, detergents or bleach-based cleaning agents as these will damage the surface.**
- You can use a ceramic hob scraper (available through Hob Brite and good local stores) to remove spilled food remains and stubborn marks from the surface.
- **Sugar-based food such as custard and syrup should immediately be scraped off without waiting for the surface to cool down. Otherwise the hob may be permanently damaged.**
- Cleaning material that is suitable for ceramic hobs may damage other parts of your cooker, so take care with surrounding parts.

## Control panel

Wipe over the control panel with a damp cloth and polish with a dry cloth. Do not use oven cleaners or aerosols, scouring pads or abrasive powder for cleaning the plastic knobs or end caps as damage will occur. Do not attempt to remove any of the control knobs from the panel as this may cause damage and is a safety hazard.

## Grill interior

Wipe the grill elements with a damp cloth (ensuring they are sufficiently cool first) to remove any fat splashes. This will prevent fumes from any fat being burned off when the cooker is next used.

## Oven interior

Remove the rod shelves for washing in the sink.

Use a fine steel wool soap pad for removing stubborn stains from the rod shelves and

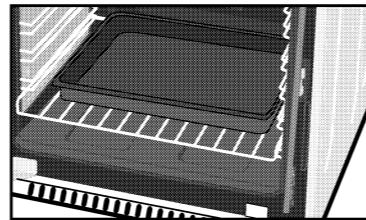

floor of the oven. Take care during cleaning not to damage, bend or dislodge from the surrounding clips the thermostat sensor which is located at the top right hand side of the oven.

Catalytic liners should never require cleaning if very hot temperatures are used regularly.

## Grill / Oven doors

Wipe over the door outer panels with a cloth wrung out in hot soapy water, then after wiping with a cloth wrung out in clean water, dry with a soft clean cloth. Do not use scouring pads or abrasive powder which may scratch the surface. Take care during cleaning not to damage or distort the door seal. Ensure that the door seal is dry after cleaning. Do not lift the door seal.

The inner glass door panels can be removed for cleaning. Open the door fully and gently lift out the glass using extreme care to ensure that the edges of glass are protected. Clean as above, but do not use household detergents, bleach, scouring pads or rust removers. Reinstall the glass panels carefully preventing sudden shocks.

**\* The inner glass is low emissive glass for maximum efficiency and the printed surface must face outwards.**

## Over time...

- Slight discolouration of liners and other surfaces may occur in time. This does not affect the functioning of the appliance.
- Discolourations and marks that occur on the ceramic hob are normal and not a fault.

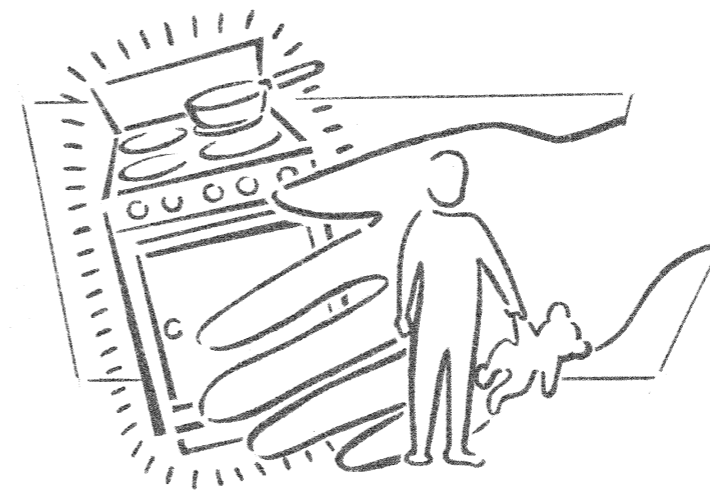

## Look after yourself, family and friends

- **Ensure that children are kept away whilst the cooker is in use and until it has cooled as parts become very hot. Don't leave them unsupervised.**
- Never stare at halogen heating units.
- During use surfaces get hot. Don't touch hot surfaces during use.
- Close supervision while cooking is essential at all times.
- Special care should be taken when cooking oily and fatty food as overheating of such food can cause them to catch fire.
- Always use good quality oven gloves when removing hot utensils and the grill pan from the oven.
- Ensure handles of pans can not accidentally be caught or knocked and do not get heated by adjacent heating zones.
- Check all controls on the appliance are switched off after use.
- Take care when opening the door. Let steam and hot air escape before removing the food.
- Select the correct shelf position before turning the oven or grill on - don't move oven shelves when hot.
- Don't use water to extinguish oil or fat fires.
- Don't heat up unopened food containers as pressure can build up causing the container to burst.
- Don't use round-bottomed traditional woks. Use flat-bottomed types.
- Don't store items above the cooker that children may try to reach.

- This appliance is not intended for use by person with reduced physical, sensory or mental capabilities or lack of experience and knowledge unless they have been given supervision or instruction concerning use of the appliance by a person responsible for their safety. Children should be supervised to ensure that they do not play with the appliance.

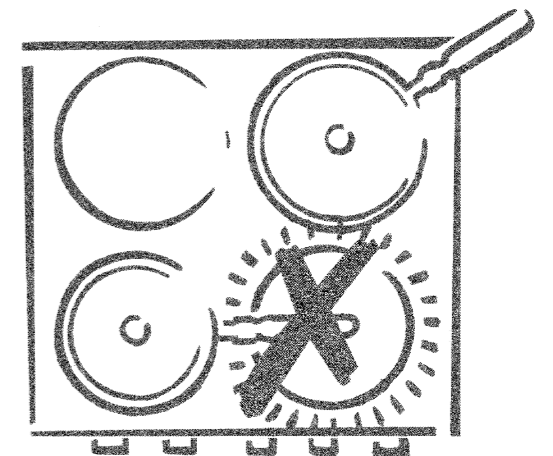

**This appliance is not intended for use by person with reduced physical, sensory or mental capabilities or lack of experience and knowledge unless they have been given supervision or instruction concerning use of the appliance by a person responsible for their safety. Children should be supervised to ensure that they do not play with the appliance.**

# safety in the home



## Look after your cooker and home

- Clean your cooker regularly, ideally after each use. Always turn off the mains electricity supply and allow the appliance to cool first.
- Spillage should be dealt with as soon as it occurs, taking due care as the hob surface may be hot. Any spillage left on the surface after cooking should be cleaned off before the hob is switched on again to prevent baking on.
- Don't use biological washing powder or bleach products, harsh abrasives or chemical cleaners for cleaning the oven inner panels.
- Don't allow anyone to sit or stand on the cooker or door.
- Don't move the cooker by pulling by the door and/or handle.
- Don't use large preserving pans or fish kettles across the hob as this will damage the ceramic hob.
- Ensure that no flammable materials are adjacent to the cooker as the sides become hot during use.
- Don't store flammable materials, aerosols etc in adjacent cabinets.
- Don't place flammable or plastic items on or near the hob, and never place wet cloths etc. on the hob to dry.
- Keep all ventilation slots clear of obstructions.
- Don't leave a hob on for long periods when not covered by a pan.
- Don't cover shelves with metal foil as the air circulation in the oven will be disrupted.
- Don't place dishes, pans and/or trays directly on the oven compartment base.
- Don't line the grill pan with aluminium foil.
- Don't use the cooker with glass panels removed.

## Don't use the cooker for

- Hanging towels and dish cloths etc on the handles.
- Warming plates under the grill.
- Heating the kitchen.
- Drying.
- Storage of inflammable materials or liquids in the storage compartment.

## Food hygiene

- Ensure meat and poultry is thoroughly defrosted before cooking.
- Check food is thoroughly cooked and is piping hot.
- **Always refer servicing to a qualified appliance service engineer.**

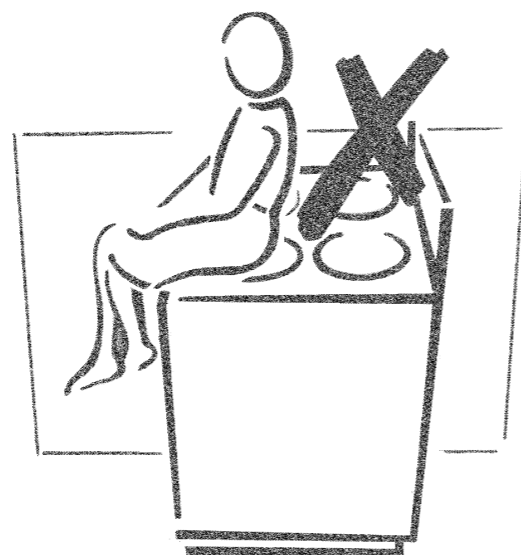

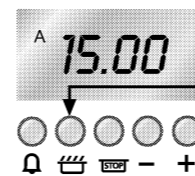

At the end of the cook period the **A** symbol will flash and an intermittent beeping sound will be heard. The  symbol will go out. The beeping sound will continue for several minutes unless cancelled (see Step 6). The **A** symbol will continue to flash until the timer is returned to manual operation (see below).



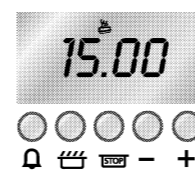

**Step 6** Press the  cook period button to cancel the beeping.



**Step 7** Turn the oven control to the OFF position.

**Step 8** Press the  cook period and end time buttons together to return the cooker to manual operation. The **A** symbol will go out and the  symbol will light up.

When cooking automatically the cook period can be checked at any time by simply pressing the  cook period button. To cancel the auto cooking programme before or after automatic cooking starts, press the  cook period and  end time buttons together. This will return the cooker to manual operation.



At the end of the automatic cook period the **A** symbol will flash and an intermittent beeping sound will be heard. The symbol will go out.  
The beeping sound will continue for several minutes unless cancelled (see step 8). The **A** symbol will continue to flash until the timer is returned to manual operation (see below).

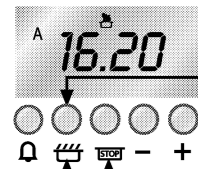

**Step 8** Press the cook period button to cancel the beeping sound.

**Step 9** Turn the oven control to the OFF position.

**Step 10** Press the cook period and end time buttons together to return the oven to manual operation. The **A** symbol will go out and the symbol will light up.

**Notes:**

When cooking automatically the cook period can be checked at any time by simply pressing the cook period button and the end time button. To cancel the auto cooking programme before or after auto cooking starts, press the cook period and end time buttons together. This will return the cooker to manual operation.

**(b) To set the timer to switch ON immediately and OFF automatically after a set cook period.**

**Step 1** Check that the correct time of day is set. If not follow instructions for setting the time of day.

**Step 2** Place food onto the correct shelf position in the oven and close the oven door.

**Step 3** Turn the fan oven control to the required temperature.



**Step 4** Press and hold the cook period button, the display will read **0.00** and the symbol will light up.

**Note:** The cook period is the length of time the food requires to cook.

With the cook period button still held set the required cook period using the "+" and "-" buttons the **A** symbol will light up. **e.g.** 1 hour 30 minutes.



**Step 5** Release all buttons.

The timer display will revert to the time of day with the **A** and symbols remaining lit.



Some of the illustrated details may vary

## specification

Front-right burner	1.0 kW
Rear-right burner	2.0 kW
Front-left burner	2.0 kW
Rear-left burner	3.0 kW
Center (Wok) burner	3.3 kW
Supply voltage	230V~ 50Hz
Low-high grill wattage	1100-1900 W
Left hand side fan oven wattage	1800 W
Right hand side conventional oven wattage	1900 W
Extended plate wattage	140-240mm 1100/2000 W
Lamp	15 W x 2
Total power (gas)	11.3 kW
Total power (electric)	7700 W
Ignition	Auto electric on all burners

External dimensions width x depth x height	1000mm x 600mm x 900mm
Cooker height with glass lid raised	1480mm.

Safety device	Gas valves are lockable
---------------	-------------------------

Gas	Supply Pressure	Destination Countries
G20	20 mbar	GB, IE
G31	37 mbar	GB, IE

I 2H AT 20 mbar and I 3P AT 37 mbar

Cat II 2H3P

For Cooker set up condition please refer to rating label

Because we continually strive to improve our products, we may change our specifications and designs without prior notice.

**Accuracy**

Note that times and temperatures in this book are for guidance only.



# electrical connection

- Do not connect the cooker to the electricity supply until all packing and transit protectors have been removed.
- Before your appliance is connected to the mains electricity supply, check to ensure that the voltage and frequency shown on the rating label corresponds with your power supply. The label is located on the plinth below the oven door.
- This product must only be installed by a qualified electrician** eg local electricity company or NICEIC registered contractor to a suitable double-pole control unit with a minimum contact clearance of 3mm in all poles and with a minimum rating of 35A which should be fitted adjacent to (but not above) the cooker in accordance with IEE regulations. **Failure to observe this instruction may result in operational problems and invalidation of the product warranty.**

- Access to the mains terminal is gained by removing the small rear cover. The cable must have conductors of sufficiently high cross sectional area to prevent overheating and deterioration. Recommended cross-section area is six square millimetres (6.00 mm<sup>2</sup>). The mains cable must conform to BS6004.
- This appliance must be earthed.**
- The mains cable must pass through the cable clamp.
  - The mains cable should be routed away from the appliance and in particular ventilation slots, the vent outlet and should not be obstructed when pushed in to position between the appliance and the wall and/or cabinets.
    - The appliance conforms to BS 800: 1988 and EEC directive 87/308 regarding suppression of radio and television interference.
    - Type with regard to protection against overheating of surrounding surfaces=X.



# location

- Excess steam from the oven is expelled at the rear of the appliance therefore the wall behind the cooker needs to be protected against grease and moisture.
- The cooker is designed to fit between kitchen cabinets spaced over 1000 mm apart. The space either side of the cooker need only be sufficient to allow withdrawal of the cooker for servicing. It can be used with cabinets on one side or both sides as well as in a corner setting. It can also be used free-standing. Avoid having cabinets protruding beyond the front of the cooker, if this can not be avoided, allow 5cm clearance between the cooker and cabinets on both sides of the cooker.
- Adjacent side walls above the appliance must not be nearer to the cooker than 100mm and should be of heat resistant material. Leave at least 750 mm clearance above the hob.
- The cooker should not be placed on a raised base.

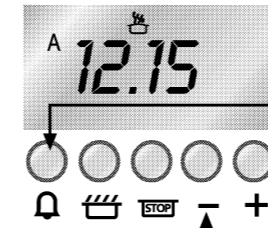
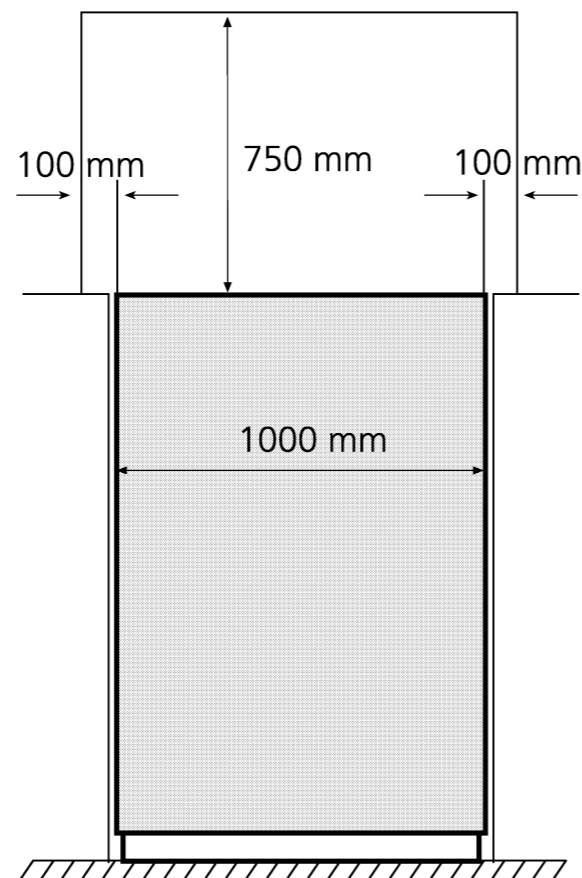

To cancel the minute minder before the minute minder period has finished.

**Step 1** Press the minute minder button.

**Step 2** Press the "-" button until 0.00 and the symbol appears in the display window.

**Step 3** To cancel the bleeping sound press the minute minder button.

## Automatic Cooking Programmes

The main fan oven only is programmable.

When the timer has been set for the main oven it is possible to use the conventional oven manually during the same automatic programme.

There are two automatic cooking programmes that can be selected using your timer:

**(a)** To set the timer to switch the oven ON and OFF automatically.

**(b)** To set the timer to switch on immediately and OFF automatically after a set cook period.

## Note

When the minute minder has been set the time remaining can be checked at any time by simply pressing the minute minder button.

## (a) To set the timer to switch the oven ON and OFF automatically.

This allows you to cook at a specific time for a chosen period before the oven switches off automatically.

**Step 1** Check that the correct time of day is set. If not follow instructions for setting the time of day.

**Step 2** Place food onto the correct shelf position in the oven and close the oven door.

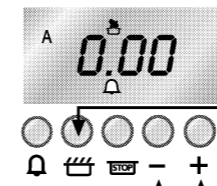

**Step 3** Press and hold the cook period button. The display will read 0.00 with the cookpot symbol lit.

**Step 4** With the cook period button still held in set the required cook period using "+" and "-" buttons.

**Step 5** Press and hold the end time button. The display will read the earliest possible time for the cook period that you have set above.

**Step 6** With the end time button still held in, use the "+" and "-" buttons to set the end time. **i.e.** The time you require the oven to switch off and the food is cooked.

**Step 7** Turn the oven control to the required temperature.

Release the buttons and the timer display will revert to the time of day with the **A** symbol and symbol lit.

Release all the buttons and the timer will revert back to the time of day.

The **A** symbol will remain lit to signify that an automatic cooking programme has been set. The symbol will go out.

When the auto cook programme starts the symbol will then light up again.

## Setting the Time of Day

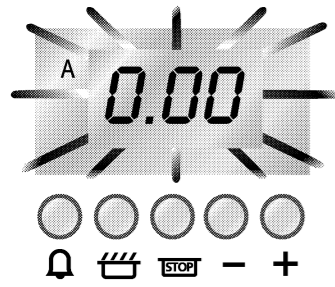

**Step 1** Make sure all oven controls are turned **OFF**.

**Step 2** Check the electricity supply to the cooker is turned **ON**.

When switched on the display will show **0.00** and the **A** symbol, both will be flashing.

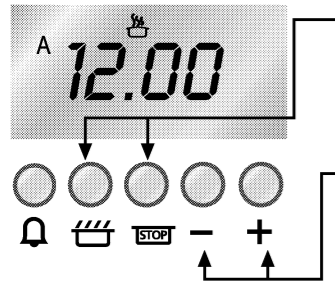

**Step 3** Press hold in both the cook period & end time buttons together.

**Step 4** With the cook period & end time buttons still held in, press either + or - buttons to set to correct time of day.

**Step 5** Release all the buttons simultaneously.

The time of day is now set and the symbol will light up to show that the timer is in Manual Mode.

**NOTE:** To change the time of day repeat steps 3, 4 & 5 above.

## Setting the Minute Minder

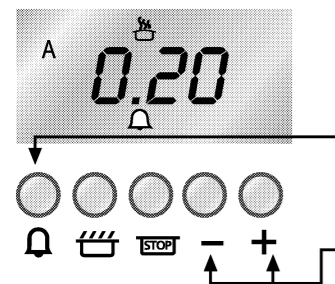

**Step 1** Ensure the time of day is set correctly.

**Step 2** Press and hold the minute minder button.

**Step 3** With the button still held in set the required minute minder time using "+" and "-" buttons.  
**A** symbol will light up.

**Step 4** Release all buttons and the timer display will revert back to the time of day.

The symbol will remain lit to signify that a minute minder period has been set.

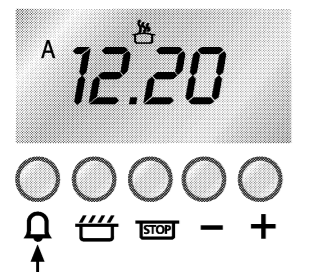

At the end of the set time a beeping sound will be heard and the symbol will go out.

The beeping sound will continue for several minutes unless cancelled (See Step 5)

**Step 5** To cancel the beeping sound press the minute minder button. The time display will revert back to the time of day after the button is released.

## Unpacking

All packing materials, protective film and transit protectors must be removed.

## Installers

**The appliance must only be installed by a competent person.**

In the UK, CORGI registered installers (including the Regions of British Gas) undertake to work to safe and satisfactory standards.

## Regulations

The cooker must be installed in accordance with the Gas Safety (Installation and Use) Regulations and the relevant Building Regulations in force.

## Ireland only

This appliance must be installed in accordance with the Domestic installation of gas (Irish Standard) in force

Failure to install the appliance correctly could invalidate the warranty and lead to liability claims and prosecution.

## Levelling

The appliance should be located on a level surface. The two front and rear feet can be adjusted as required. To ensure that your appliance is standing level adjust the two front or rear feet by turning clockwise or anticlockwise until the product is in firm contact with the floor.

## Stability Chain

The cooker must be secured by the security chain to the wall or partition behind the cooker.

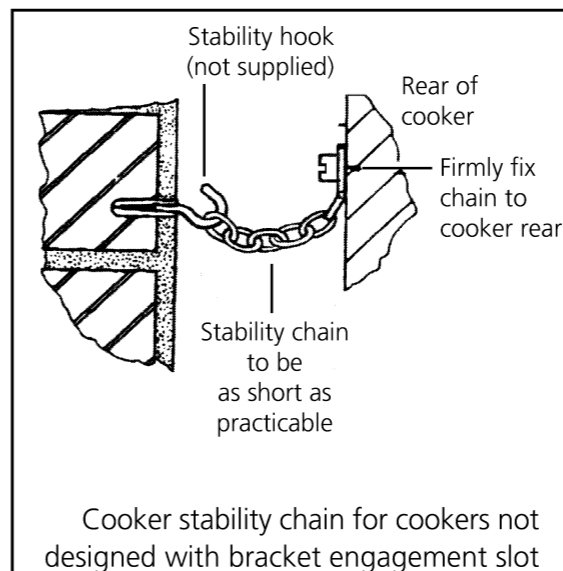

## Moving your cooker

If your cooker is fitted with a flexible hose the cooker can be moved for cleaning. Make sure that the floor covering is firmly fixed or removed to prevent it being disturbed.

**TAKE CARE NOT TO STRAIN OR DAMAGE THE GAS HOSE (OR ELECTRICITY SUPPLY CABLE) WHEN MOVING THE COOKER.**

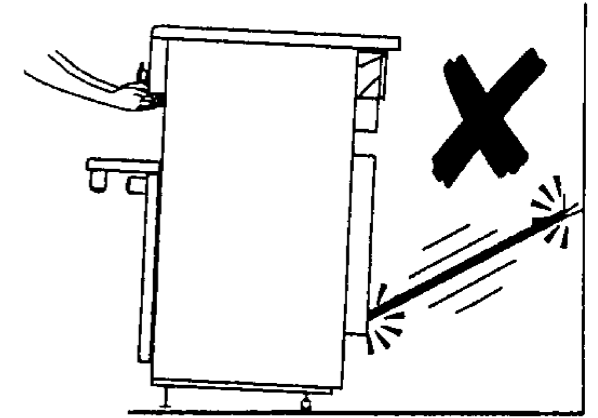

Release the stability chain as you ease the cooker out. Don't forget to refit it when you replace the cooker.

Lift the front feet clear off the floor by lifting at the ends of the hotplate fascia. Do not move by pulling the door handle or knobs.

Move the cooker a bit at a time, checking behind it to make sure that the gas hose has sufficient slack to allow the cooker to move forward as you go along.

When you replace the cooker, again check behind to make sure that the gas hose or cable are not caught or trapped. Take care not to twist it within the gap between the kitchen units as damage may occur to the cooker or the units.

Check that the cooker stability chain has been reconnected.



# preparation and burning off



## Important for asthmatic sufferers

Before using for the first time, protective coatings need to be burnt off. Fumes will be emitted but this is quite normal.

**Ensure the room is very well ventilated during the burning off process. Avoid directly inhaling the fumes during this process.**

**Grill** Open the grill door. Remove wire rack, baking tray and handle, and set the control to 3  for about 15 minutes.

## Oven/s

Remove shelves and baking tray and turn the oven control knobs to 200°C for about 15 minutes.

## Cleaning

Before you start using your cooker, clean the appliance as recommended under Care and cleaning on page 23.

# operating the clock/programmer





**The timer display is in 24 hour clock format.**

**Ensure that the correct time of day is always set before using your cooker. The clock must be set before the fan oven can be operated.**

**A** will light:

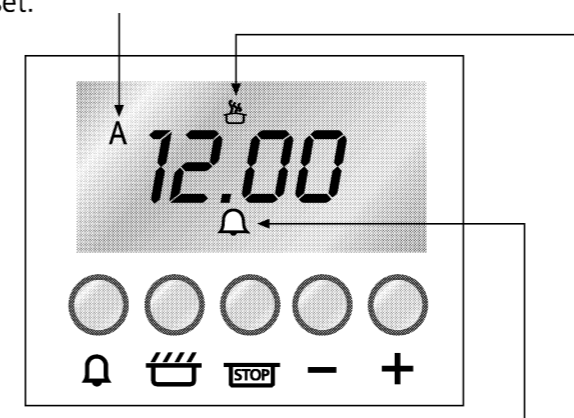
- When the timer is first turned on it will flash. (It should go out when the time of day is set).
- When an Auto Cooking programme has been set.



 This "Cookpot" symbol will light up either.

- When the cooker is in "Manual Mode".
- When you press the  Cook Period button and set a length of time for an Automatic Cooking programme.

 **symbol will light up during Automatic Cooking.**

 will light up when you select a Minute Minder period and will remain on for the period set.

## **minute minder**

Here you can set a time period of up to 23 hours and 59 minutes that will count down.

When it reaches zero the timer will bleep.

e.g. If you set 20 minutes, the timer will start beeping 20 minutes later.

## **cook period**

Cook Period is the actual length of time for which, the timer will switch the oven on as part of an "Automatic Cooking" programme.

e.g. If you set 2 hours, the food will be cooked for 2 hours.

## **end time**

The time of day at which you want an automatic cooking programme to **end**.

**e.g.** If you set a cook period for 2 hours, and end time of 11:00. The timer will switch the oven on at 9:00 and turn the oven off at 11:00. You will hear a bleep at 11:00 to indicate that the automatic cooking programme has finished.

## **Notes**

- When setting an automatic cooking programme you will need to set the oven control to the required temperature when you set the timer.
- If an automatic cooking programme has been set the oven will only operate during the pre-programmed time.

## **"+" and "-"**

- Used to adjust the various timer function settings.
- Used to adjust pitch of audible tone.

# operating the fan oven

**!** The clock must be set before the oven can be operated. (See page 19)

- 1 Turn the oven on by rotating the oven control knob clockwise.
- 2 Select the temperature in the oven by selecting the temperature (in degrees Celsius) printed on the control panel.
- 3 The amber temperature indicator light on the control panel will glow until the pre-set temperature is reached.
- 4 Once the temperature has been reached, the amber light will go off and then cycle on and off to maintain the pre-set temperature.

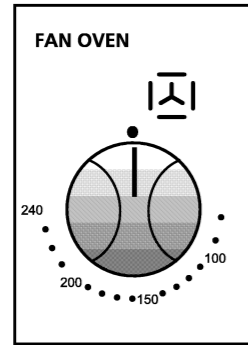

## Temperature conversion

The oven temperature control knob is marked in degrees Celsius (sometimes called Centigrade). This chart will help when recipes show °F or use descriptive terms (as recommended by the Association of Manufacturers of Domestic Electrical Appliances).

Description	Celsius °C	Fahrenheit °F
Cool	70	150
	80	175
	100	200
	110	225
Slow	120	250
	140	275
	150	300
Fairly hot	160	325
	180	350
Hot	190	375
	200	400
Very hot	220	425
	230	450

**!** Ensure you stand back from the appliance when opening the oven door to allow any build up of steam or heat to escape.

- Check food is thoroughly cooked and is piping hot.
- As a fan oven heats up more quickly and generally cooks food at a lower temperature than a conventional oven, preheating the oven is often unnecessary. However, food such as bread, scones, Yorkshire pudding, do benefit from being placed in a pre-heated oven.

## Fan oven temperature chart

This chart is for guidance only, follow food manufacturers recommendations whenever available.

Food	Cooking temperature °C	Time	Shelf position
Beef	160-180	20-25 mins per 450g +20 mins	2
Lamb	160-180	25 mins per 450g + 25 mins	2
Pork	160-180	25 mins per 450g + 25 mins	1-2
Poultry up to 4kg (8lbs)	160-180	18-20 mins per 450g + 20 mins	1-2
Poultry up to 5.5kg (12lbs)	150-160	14-16 mins per 450g + 20 mins	1-2
Casseroles	140-150	1.5-2 hours dependent on quantity	1-2
Fruit cake	130-140	Time dependent on size	2-3
Small cakes	160-180	15-25 mins	4
Victoria sandwich	160-180	20-25 mins	1

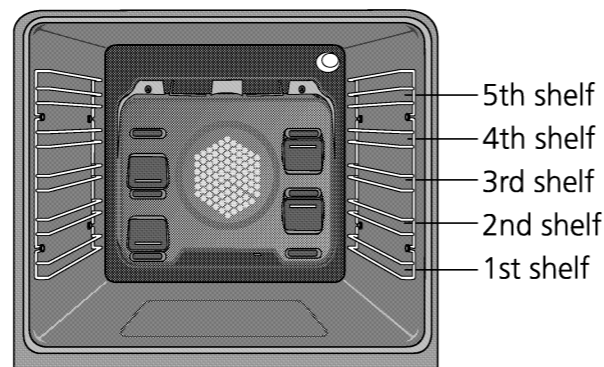

# gas connection

## Gas supply

Your oven must only be used on natural gas or LP gas.

## Natural Gas

The cooker is designed for UK and Ireland installation using a flexible connection with tubing in accordance with the regulations in force. Length of 900mm is recommended (Ireland 600 mm).

## LP Gas

For flexible connections use a bayonet type hose, suitable for use on LP Gas up to 50 mbar pressure rise. The flexible hose should be coloured black with a red stripe, band or label.

## Gas flexible hose

If a flexible hose is used it must not come into contact with the top 150mm/6 inches (the shaded area on the diagram) of the rear of the appliance.

Do not pass the hose through the hot region behind the oven.

## Connection

Connect the flexible gas hose to the oven as follows.

- 1 Use nonsetting gas sealant on the connection to the cooker.
- 2 Connect to the gas supply pipe at the rear of the cooker (1/2 in BSP).
- 3 Assemble burner caps and rings fit pan supports in position. (left and right sides)
- 4 Turn on the gas supply and check for soundness.
- 5 Light two burners and check that the pressure is correct.

## Gas leaks

**!** If you smell gas, turn off all gas controls and extinguish any open flame. Open a window to ventilate the room. Don't touch any electrical switches. Contact your local Gas Supplier immediately.

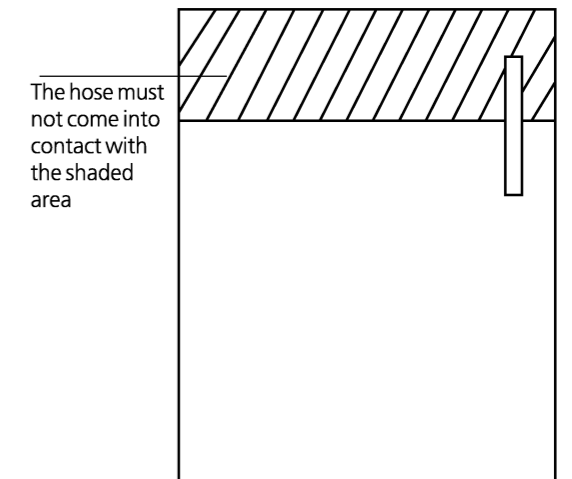

The hose must not come into contact with the shaded area

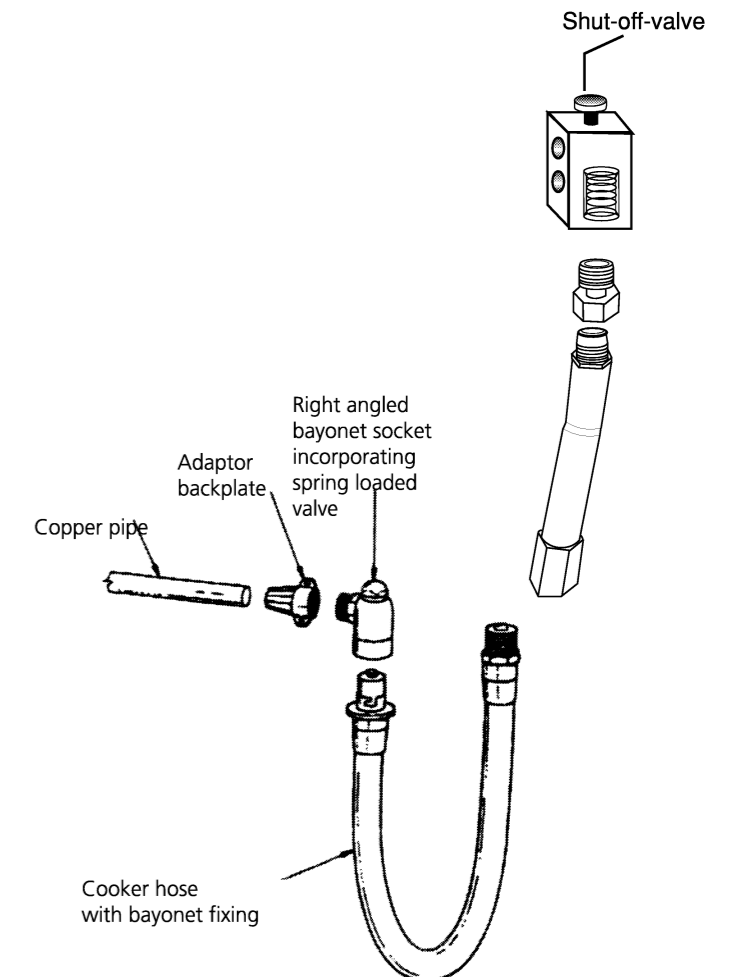

# gas conversion

Ensure that the local distribution and adjustment conditions are compatible.  
Check the rating plate to identify cooker preset condition.

## Conversion from natural gas to LPG

The conversion must only be implemented by a qualified engineer.

1. Replace the natural gas orifices by the LPG equivalents.
2. Check gas soundness.
3. Take out the top lid, remove the burners' plate and remove the control panel as explained on the previous page.
4. Ignite the burner that should be adjusted, turn the knob to the reduced position, pull and take the knob off.
5. Adjust the reduced rates of the burners.

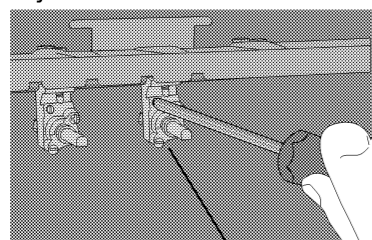

A: Hob burner tap

### A. Hob burners

\* Adjust screw "A" 1-1 1/2 turns clockwise to obtain flame length of about 5 mm.  
\* Adjust each burner separately.

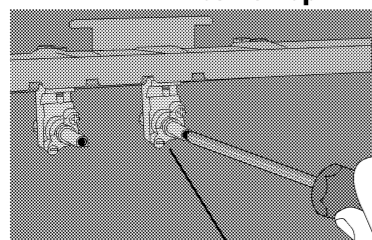

A: Hob burner tap

### A. Hob burners

\* Adjust screw "A" 1-1 1/2 turns clockwise to obtain flame length of about 5 mm.  
\* Adjust each burner separately.

### B. Oven burner

- \* Adjust screw "B" 1/2 turn clockwise.
- \* Set oven thermostat to "1".
- \* Ignite oven burner.
- \* Close oven door and wait for thermostat to operate 10-15 minutes (reduced rate).
- \* Adjust screw "B" to obtain a flame length of 2-3 mm (rotation of screw "B" clockwise will decrease, anti-clockwise will increase the flame length).

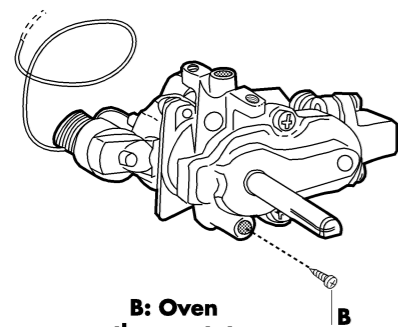

B: Oven thermostat

7. Apply the following labels;  
\* Overstick current rating plate with modified cut out label ensuring serial number is still visible.  
\* Tick appropriate LPG gas box and fix adjacent to the rating plate label.

## Conversion from LPG gas to NG

The conversion must only be implemented by a qualified engineer.

1. Replace the gas orifices by the NG equivalents.
2. Check gas soundness.
3. Take out the top lid, remove the burners' plate and remove the control panel as explained on the previous page.
4. Ignite the burner that should be adjusted, turn the knob to the reduced position, pull and take the knob off.
5. Adjust the reduced rates of the burners.

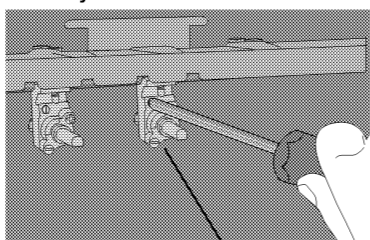

A: Hob burner tap

### A. Hob burners

\* Adjust screw "A" 1-1 1/2 turns anti clockwise to obtain flame length of about 5 mm.  
\* Adjust each burner separately.

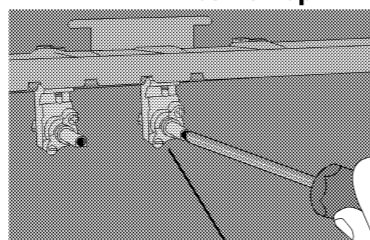

A: Hob burner tap

### A. Hob burners

\* Adjust screw "A" 1-1 1/2 turns anti clockwise to obtain flame length of about 5 mm.  
\* Adjust each burner separately.

### B. Oven burner

- \* Adjust screw "B" 1/2 turn anticlockwise.
- \* Set oven thermostat to "1".
- \* Ignite oven burner.
- \* Close oven door and wait for thermostat to operate 10-15 minutes (reduced rate).
- \* Adjust screw "B" to obtain a flame length of 2-3 mm (rotation of screw "B" clockwise will decrease, anti-clockwise will increase the flame length).

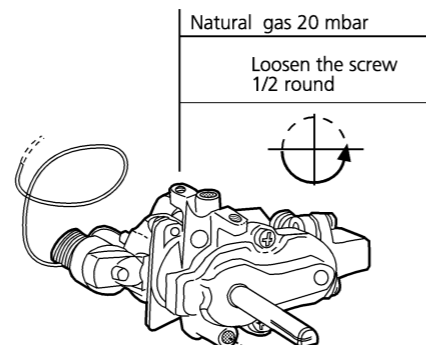

B: Oven thermostat

6. Apply the following labels;  
\* Overstick current rating plate with modified cut out label ensuring serial number is still visible.  
\* Tick appropriate NG gas box and fix adjacent to the rating plate label.

# operating the conventional oven



The two ovens in your cooker are of different types. The left hand oven is a fan oven. The fan circulates the warm air which results in faster heat transfer to the food.

The right hand conventional oven is fitted with two heating elements, one is visible in the top of the oven and the second element under the oven base.

During use the appliance becomes hot. Take care to avoid touching the top element and deflector when placing or removing items from the oven.

- 1 Turn the oven on by rotating the oven control knob clockwise.
- 2 Select the temperature in the oven by selecting the temperature (in degrees Celsius) printed on the knob.

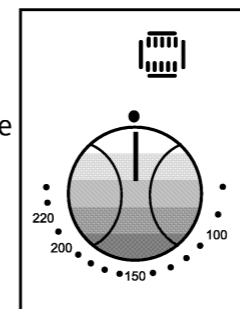

- 3 The amber temperature indicator light on the control panel will glow until the pre-set temperature set is reached.
- 4 Once the temperature has been reached, the amber light will go off and then cycle on and off to maintain the pre-set temperature.

Ensure you stand back from the appliance when opening the oven door to allow any build up of steam or heat to escape.

- Check food is thoroughly cooked and is piping hot.
- When cooking using both shelves, rotate the food to ensure even cooking/baking results.



### Oven temperature chart

This chart is for guidance only, follow food manufacturers recommendations whenever available.

Food	Cooking temperature °C	Time	Shelf position
Beef	180-190	30 mins per 450g + 30 mins	2
Lamb	180-190	30 mins per 450g + 30 mins	2
Pork	170-180	40 mins per 450g + 40 mins	1-2
Poultry	180-200	25-30 mins per 450g + 25 mins	1-2
Casseroles	140-160	1.5-2 hours dependent on quantity	1-2
Fruit cake	140-160	Time dependent on size	2-3
Small cakes	160-180	20-25 mins	4
Victoria sandwich	160-180	20-25 mins	1

## Temperature conversion

The oven temperature control knob is marked in degrees Celsius (sometimes called Centigrade). This chart will help when recipes show °F or use descriptive terms (as recommended by the Association of Manufacturers of Domestic Electrical Appliances).

Description	Celsius °C	Fahrenheit °F
Cool	70	150
	80	175
	100	200
Slow	110	225
	120	250
	140	275
Fairly hot	150	300
	160	325
Hot	180	350
	190	375
Very hot	200	400
	220	425
	230	450
	250	480

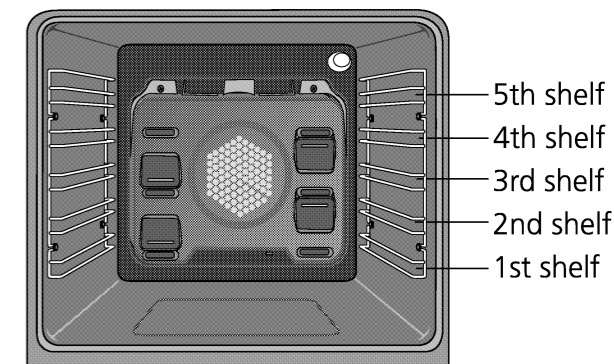

Switching the dual grill control clockwise to 3 provides full width grilling, turning anticlockwise to 3 only half of the grill element width will function.

**Parts may become hot when the grill is in use, children must be kept away.**

**As a safety feature, a switch prevents the grill from working when the door is closed. It will only work when the door is fully open.**

- When the door is fully open, it remains tilted slightly, so that any spillage will be directed away from you.

1 Open the grill door.

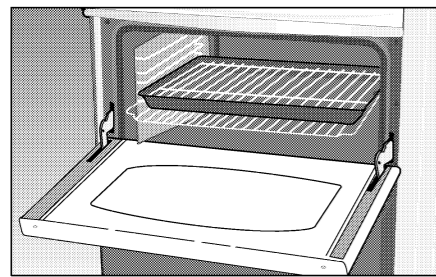

2 Turn the grill on by turning the grill control knob to position 2 and allow to preheat for around 5 minutes.

3 The red indicator light will glow to show that the grill has been switched on.

4 Then choose the desired setting.

**Only use the middle and bottom rack position for grilling. Do not use the top position.**

- Ensure the food is correctly positioned under the grill element.

- Food which requires browning only should be placed under the hot grill, either in the grill pan, or on the floor of the grill compartment, according to the depth of the dish. The grill pan wire grid can be removed.

- Do not line the grill pan with aluminium foil.

- Plates and dishes placed on the floor of the grill compartment will be heated when the main oven is in use.

- Do not switch on the grill when using the compartment for storage.

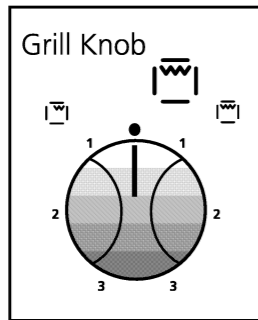

## Grilling guidelines

Use setting 3 for toast, for sealing and fast cooking of foods.

For thicker foods requiring longer cooking, turn the control to a lower setting after the initial sealing on both sides. The thicker the food, the lower the control should be set. When grilling thicker food, the grill rack should be turned over to its lowest position.

## Use of grill pan handle

**Warning! Always use an oven glove to protect your hand when using the grill as all metal parts can become very hot.**

The grill pan has a detachable handle. Make sure the handle is securely located between the raised profiles across the front of the grill pan. See the diagrams for fitting the handle. To remove the handle, reverse the sequence of operations.

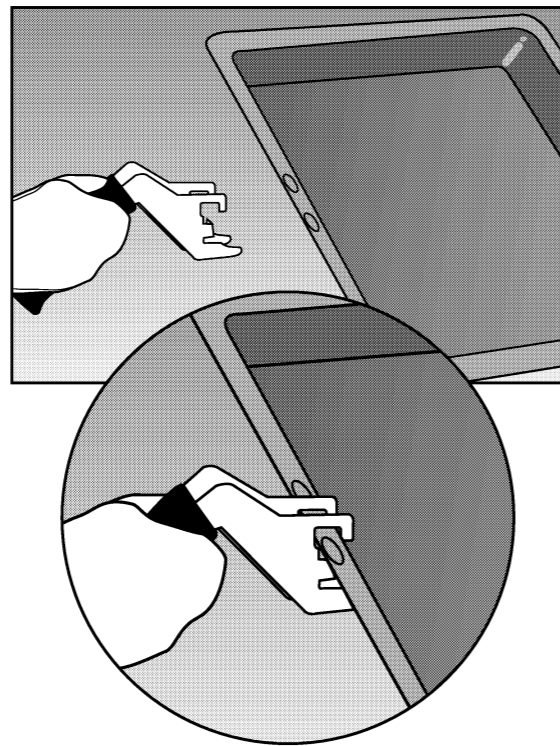

**Always take care not to touch hot surfaces when using the grill pan handle. Ensure when using the grill pan handle that it is centralised and secure. Do not leave the handle in position when grilling. If the handle is left in position when grilling, it will get very hot.**

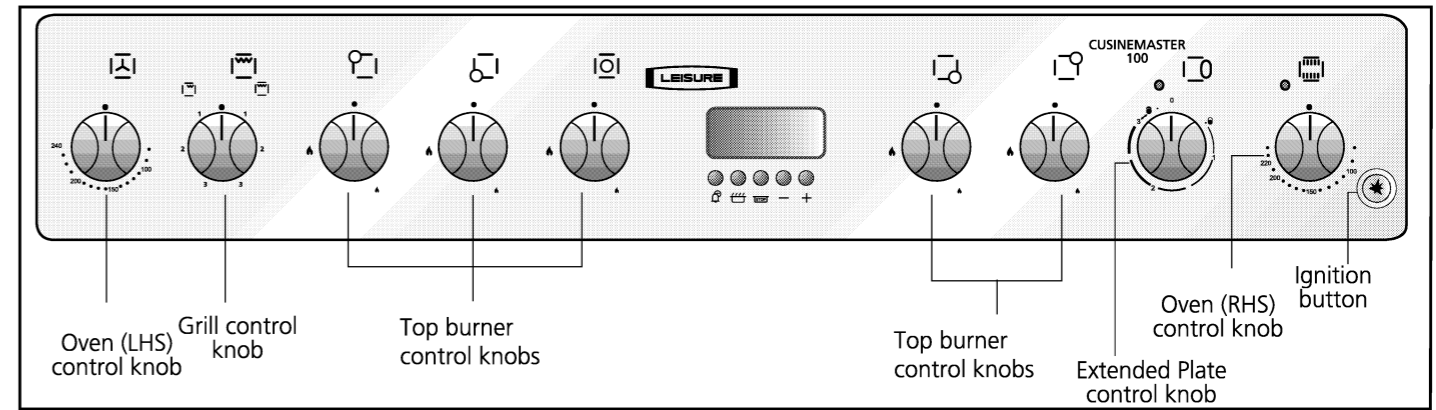

## Turning on and off

### P models,

All burners are protected by flame failure devices, if the flames are extinguished for any reason the gas will automatically be cut off.

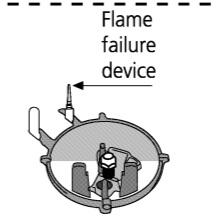

The burner control knobs have a safety feature.

1 Push the appropriate knob in slightly and turn anti-clockwise to the required setting.

2 While keeping the knob depressed press the ignition button.



3 Keep the knob depressed for 15 seconds after the burner has lit to override the safety device.

4 To switch a burner off turn the corresponding knob to ●.

- Turning the control knob fully anti-clockwise to the small flame symbol enables you to simmer without accidentally switching off.

## Ignition button

- Pressing this button provides a spark at all burners, only the one turned on will light.
- If a hob burner doesn't light, press again until it does.

## Flame control

- When turning on a hotplate burner, stay and make sure that it has lit, and adjust the flame immediately.
- Selection of the correct flame height is especially important to safety.** Adjust the burner flame so that it does not extend beyond the bottom of the pan, any higher and the flame becomes inefficient and can be a potential fire hazard.
- To make sure that the cooker is operating safely, periodic checks are advised.

- At low settings, do not leave the burners unattended for long periods of time.
- The burner flames should burn with a visible bluish cone within the main flame, and with no sign of yellowness. If at the first lighting they are very noisy and yellow, turn out at once and check that the burner cap has been correctly replaced. If on re-lighting there is no improvement, ask your supplier to check them. The inner portions of the flames as described above may not be very clear, but this is not detrimental in anyway. The pan supports are not interchangeable.

## Dual cooking zone

This cooking zone has inner and outer heating area's. The first stage is the inner section for small pots and pans and the outer combined with the inner section for larger pans.

To operate turn the control knob clockwise and the inner section of the hotplate will heat up. To adjust the heat level select 1 to 3 by turning the knob.

To select the inner and outer heating area's rotate the control past 3 until a click noise is heard, both inner and outer sections will heat up.

Rotate the control past this point to select the required heating level.

To turn off both heating zones turn the control knob anti-clockwise to the "0" position.

**Note: The outer heating zone will not operate independently from the inner section.**

Corresponding cooking values			
3 stages heating	1	2	3
7 stages heating	1	2 - 3	4 - 5 - 6
Application	Position to hold hot	Simmering	Cooking-roasting boiling

## Hob hot indicator light

For your safety, these illuminate to show which hob is hot. They remain alight even when the hob is switched off. The light will go off when the temperature falls below 64°C.



Do not touch and keep children away from the heating zones and appliance at all times.

## Ceramic hob care

The ceramic glass surface is tough in everyday use and its flat surface makes it easy to clean but please follow the following precautions.

- **Immediately switch off the appliance from the mains if a crack is detected on the ceramic glass surface and refer to the Guarantee section.**



- **Keep children away from hot surfaces.**
- In order to avoid hob soilage, make sure the bottom of the utensils and the hob surface are clean and dry before use.
- Do not use the surface for food preparation eg cutting bread or slicing vegetables and fruit.

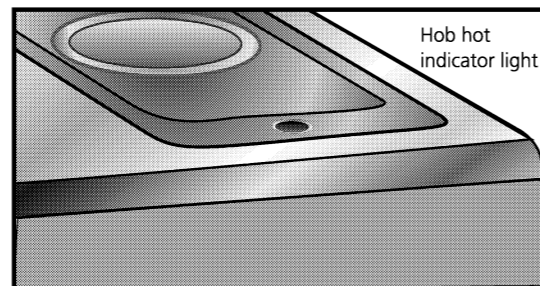

- Do not use the surface for storing or any other non-cooking purpose.
- The scratching or dropping of sharp cornered pots onto the surface may cause damage.
- Do not place any material on the surface, such as plastic, aluminium, etc.
- Any such material that may have melted onto the surface should immediately be removed with a hob scraper.
- Never use a dishcloth or sponge to clean the ceramic hob as these may leave a layer of soiled detergent on the hob which will burn and discolour the next time the hob is used.
- Avoid heating up empty enamel pots.
- Splashes may damage the ceramic surface and can cause fire.

# deep fat frying



- Never fill the pan more than the one-third full of fat or oil.
- Never leave unattended during heating or cooking.
- Do not fry too much food at the same time especially frozen food. This only lowers the temperature of the oil or fat too much resulting in greasy food.
- Always dry food thoroughly before frying and lower it slowly into the hot oil or fat. Frozen foods in particular will cause frothing and spitting if added too quickly.
- Never heat fat or fry with a lid on the pan.
- Keep the outside of the pan clean and free from streaks of oil or fat.

## In the event of a chip pan or other pan fire

- 1 Turn off the cooker.
- 2 Smother flames with a fire blanket or damp cloth.
- 3 Do not try to remove a burning pan from the hob.  
Burns and injuries are caused almost invariably by picking up the burning pan and rushing outside with it.



**Do not use water on the fire.**  
**Leave the pan to cool for at least 30 minutes.**

# saucepans

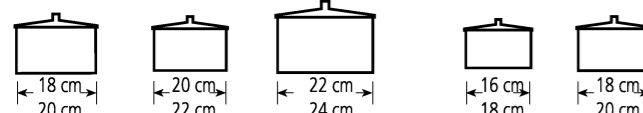
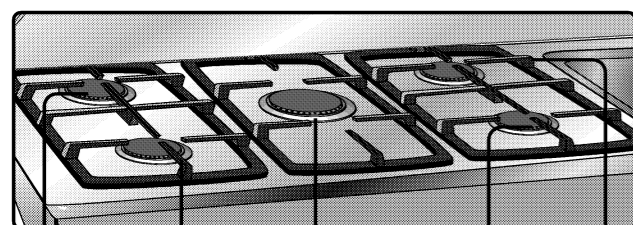

## Pan choice (Gas burners)

In choosing pans, look for pan handles that can be held easily and will stay cool. Avoid pans that are unstable and easily tipped. Pans that are too heavy to move easily when filled can also be a hazard. Only use flat bottomed pots or pans.

## Pan size

For maximum efficiency and safety, use the recommended pan sizes for each burner.

- Use pans which have sufficient capacity for the amount of food being cooked so they don't boil over and cause unnecessary cleaning.
- Do not place lids on the burners.

Always position pans centrally over the burners. When transferring pans from one burner to another always lift the pans do not slide them.

## Pan choice (Ceramic hotplate)

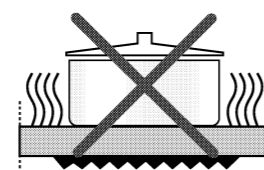
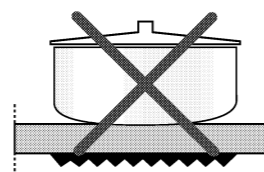
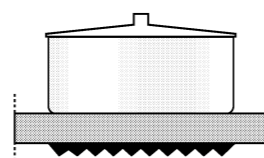

- Optimum efficiency is achieved by using pans that match the diameters of the elements
- If the pan is too small energy is wasted.

- Do not use pots that have concave or convex bottoms.
- Do not use aluminum-bottomed pots. (This results in the deterioration of the ceramic glass surface).
- Use steel or heat-resistant glass pots. Do not use pots made from materials such as "boron glass", or "Pyrex", which are generally oven-type containers.

## Glass lid

- The glass lid must be in a fully raised position before the hob burners can be used.
- The glass lid is fitted with a safety device which cuts off the gas supply to the hob burners when the lid is closed. The gas supply is restored when the lid is raised.
- Do not use the safety device to control the hob burners.
  - **Prior to closing the glass lid make sure:**
    - Hob controls are off
    - Cooking utensils have been removed
    - The hob burners have been allowed to cool.
    - Always raise the lid during oven or grill operation.

The toughened glass lid is not intended as a work surface, as it becomes hot when any part of the cooker is in use and the surface may be scratched if items with rough or sharp edges are placed on it